

EXPRESSCLUSTER[®] X 3.3 **for Windows**

Reference Guide

07/26/2018

7th Edition



Revision History

Edition	Revised Date	Description
1st	02/09/2015	New manual
2nd	04/20/2015	Corresponds to the internal version 11.31.
3rd	01/29/2016	Corresponds to the internal version 11.32.
4th	10/03/2016	Corresponds to the internal version 11.33.
5th	04/10/2017	Corresponds to the internal version 11.34.
6th	10/02/2017	Corresponds to the internal version 11.35.
7th	07/26/2018	Revised the steps of "Changing the server configuration (add/delete)" in the "Chapter 10 The system maintenance information".

© Copyright NEC Corporation 2015. All rights reserved.

Disclaimer

Information in this document is subject to change without notice. No part of this document may be reproduced or transmitted in any form by any means, electronic or mechanical, for any purpose, without the express written permission of NEC Corporation.

Trademark Information

EXPRESSCLUSTER® is a registered trademark of NEC Corporation.

FastSync® is a registered trademark of NEC Corporation.

Intel, Pentium and Xeon are registered trademarks or trademarks of Intel Corporation.

Microsoft, Windows, Windows Server, Windows Azure and Microsoft Azure are registered trademarks of Microsoft Corporation in the United States and other countries.

Amazon Web Services and all AWS-related trademarks, as well as other AWS graphic, logo, page header, button icon, script, and service names, are the trademarks, registered trademarks, or trade dresses of AWS in the United States and other countries.

Oracle, Java and all Java-based trademarks and logos are trademarks or registered trademarks of Oracle and/or its affiliates.

WebOTX is a registered trademark of NEC Corporation.

Android is a trademark or registered trademark of Google, Inc.

Other product names and slogans written in this manual are trademarks or registered trademarks of their respective companies.

Table of Contents

Preface	xxi
Who Should Use This Guide.....	xxi
How This Guide is Organized.....	xxi
EXPRESSCLUSTER X Documentation Set.....	xxii
Conventions.....	xxiii
Contacting NEC.....	xxiv
Section I	Detailed functions of EXPRESSCLUSTER..... 25
Chapter 1	Functions of the WebManager..... 27
Window of the WebManager.....	28
Main window of the WebManager.....	28
Changing the WebManager operation mode.....	30
Searching for an alert by using the WebManager.....	31
Collecting logs by using the WebManager.....	34
Updating the WebManager information.....	36
Changing the WebManager screen layout.....	37
Checking the time information from the WebManager.....	37
Executing Integrated WebManager from the WebManager.....	39
Operating a cluster and cluster services on the WebManager.....	40
Confirming the license from the WebManager.....	40
Checking the status of each object in the tree view of WebManager.....	41
The colors of the icons displayed in the WebManager tree view.....	41
Operations from the WebManager.....	59
Checking the cluster status by the WebManager list view.....	72
To display information on the whole cluster.....	72
Checking the whole status of the server in the WebManager list view.....	78
Checking the status of individual server in the WebManager list view.....	79
Checking the status of the whole monitor in the WebManager list view.....	79
Checking alerts using the WebManager.....	80
Alert view fields.....	81
Alert view operation.....	81
Mirror disk helper.....	83
Overview of the mirror disk helper.....	83
Recovering a mirror (forcefully).....	90
Stopping mirror recovery.....	93
Canceling access restriction.....	94
Manually stopping and starting the WebManager.....	95
When you do not want to use the WebManager.....	95
Setting limitations on the connection and operation of the WebManager.....	95
Type of limitation.....	96
Operating a cluster by using the WebManager.....	98
Cluster shutdown and cluster shutdown reboot.....	98
Mirror disk resource and hybrid disk resource.....	98
Recovering servers.....	98
Shutting down and rebooting an individual server.....	98
Starting, stopping, and moving an individual group.....	98
Starting and stopping a group resource.....	98
Resuming, suspending, and stopping dummy failure of monitor resources.....	98
Resuming, suspending, starting dummy failure, and stopping dummy failure of an individual monitor resource.....	98
Limitations of the WebManager.....	99
Error messages on the WebManager.....	100
Chapter 2	Function of the Builder..... 109
Overview of the Builder.....	110
Considerations for using the Builder.....	111

Limitations on using the Builder	112
Details on the Builder screen	113
Overview of the EXPRESSCLUSTER X Builder	113
Tree view	113
Table view	114
Table for cluster name selection	114
Table for group selection	114
Table for group name selection	117
Table for monitor resource selection	119
Table for server selection	119
Table for server name selection	120
Pop-up menu	121
Using a tool bar of the Builder	122
Using the menu bar of the Builder	123
File menu	123
Creating a new cluster	124
Opening the configuration file	124
Saving the configuration file	125
Get the configuration file (online version only)	126
Apply the configuration file (online version only)	126
Updating the server information (online version only)	128
Changing communication settings	129
Changing log level settings of Builder	130
Collecting Builder logs	131
Exiting from the Builder	131
View menu	132
Operation Mode	132
Config Mode	132
Reference Mode	132
Verification Mode	132
Edit menu	133
Adding an object	133
Removing an object	134
Renaming an object	135
Properties	135
Help Menu	136
Checking the version information of the Builder	136
Parameter details	137
Cluster properties	137
Info tab	137
Interconnect tab	138
NP Resolution tab	141
Timeout tab	146
Port No. tab	147
Monitor tab	149
Recovery tab	150
Alert Service tab	159
WebManager tab	167
Alert Log tab	174
Delay Warning tab	176
Disk tab	177
Mirror Disk tab	179
Account tab	181
Auto Recovery tab	183
RIP (Legacy) tab	184
Power saving tab	186
Migration tab	188
JVM monitor tab	189
Servers Properties	196
Master Server tab	196
Server Properties	199
Info tab	199
Warning Light tab	202
BMC tab	205

HBA tab	207
Parameters list	209
Upper limits of registration	253
Chapter 3	EXPRESSCLUSTER command reference..... 255
Operating the cluster from the command line	256
EXPRESSCLUSTER commands	256
Displaying the cluster status (clpstat command)	259
Status Descriptions	341
Operating the cluster (clpcl command)	345
Shutting down a specified server (clpdown command)	349
Shutting down the entire cluster (clpstdn command)	350
Operating groups (clpgrp command)	351
Collecting logs (clplogcc command)	357
Collecting logs by specifying a type (-t option)	360
Output paths of log files (-o option)	361
Specifying log collector server (-n option)	362
Specifying an event log type to collect (--evt option)	362
Collecting information when a failure occurs	363
Creating a cluster and backing up configuration data (clpcfctrl command)	364
Creating a cluster (clpcfctrl --push)	364
Backing up the cluster configuration data	369
Adjusting time-out temporarily (clptoratio command)	372
Modifying the log level and size (clplogcf command)	375
Registering the license (clplcncs command)	386
Mirror-related commands	387
Displaying the mirror status (clpmdstat command)	387
Operating mirror disk resource (clpmdctrl command)	395
Tuning partition size (clpvolsz command)	400
Controlling disk access (clpvolctrl command)	402
Operating snapshot backup of hybrid disk resource (clphdsnapshot command)	404
Displaying the hybrid disk status (clphdstat command)	407
Operating hybrid disk resource (clphdctrl command)	414
Outputting messages (clplogcmd command)	419
Controlling monitor resources (clpmonctrl command)	421
Controlling group resources (clprsc command)	429
Switching off network warning light (clplamp command)	434
Controlling CPU frequency (clpcpufreq command)	435
Controlling chassis identify lamp (clpledctrl command)	437
Processing inter-cluster linkage (clptrnreq command)	439
Requesting processing to cluster servers (clprexec command)	442
Changing BMC information (clpbmccnf command)	446
Configuring shutdown hook (clphookctrl command)	448
Controlling cluster activation synchronization wait processing (clpbwctrl command)	450
Controlling reboot count (clpregctrl command)	451
Estimating the amount of resource usage (clpprer command)	453
Checking the process health (clphealthchk command)	458
Chapter 4	Compatible command reference..... 461
Compatible command overview	462
Note on compatible commands	462
Compatible commands	462
Displaying the messages on EXPRESSCLUSTER clients (armbroadcast command)	464
Registering the messages on a log file or an alert log (armlog command)	465
Starting the applications or services (armload command)	466
Terminating the application or service (armkill command)	473
Waiting for the start or stop of groups (armgwait command)	475
Exclusive control between servers command (armcall command)	476

Retrieving the cluster wide variable or local variable (armgetcd command)	478
Setting the cluster wide variable or local variable (armsetcd command).....	479
Monitoring errors on the connection to the shared resources (armwhshr command).....	480
Controlling the applications or services started by the armload command (EXPRESSCLUSTER Task Manager)	483
Shutting down the server (armdown command)	486
Moving or failing over a group (armfover command)	487
Starting a group (armgstrt command).....	488
Stopping a group (armgstop command)	489
Starting or stopping the application or service, suspending or resuming the monitoring (armloadc command).....	490
Suspending the script execution until the user's direction (armpause command)	492
Suspending the script execution for the specified time (armsleep command)	493
Starting the network sharing of the directory (armsnadd command)	494
Stopping the network sharing of the directory (armsndel command)	495
Setting the IP address returned by gethostbyname () (armwsset command)	496
Setting or displaying the start delay time (armdelay command)	498
Setting or displaying operations at the occurrence of the emergency shutdown (armem command)	499
Shutting down the whole cluster (armstdn command).....	500
Returning the server with the status of "Suspension (isolated)" (armmode command).....	501
Permitting an access to the mirror disk (mdopen command)	502
Prohibiting an access to the mirror disk (mdclose command).....	503
Permitting an access to the shared disk (sdopen command).....	504
Prohibiting an access to the shared disk (sdclose command)	505
Error messages of the compatible commands.....	506
Section II Resource details.....	517
Chapter 5 Group resource details	519
Group resources	520
What is a group?	521
Understanding the group types	521
Understanding the group properties.....	521
Understanding failover policy	526
Operations at detection of activation and inactivation errors	531
Final action	535
Script before final action	536
Reboot count limit	538
Resetting the reboot count	542
Group start dependence and group stop dependence	543
Displaying and changing the settings of group properties	546
Renaming a group.....	546
Displaying and changing the comment of a group.....	546
Displaying and changing the settings of servers that starts up the group	546
Displaying and changing the group attribute	549
Displaying and changing Logical Service	554
Understanding setting of group start dependence and group stop dependence	556
Displaying and setting group start dependence and group stop dependence.....	557
Displaying and changing the settings of group resources	561
Renaming a group resource	561
Displaying and changing the comment of a group resource	561
Understanding the settings of dependency among group resources.....	562
Displaying and configuring the settings of dependency among group resources.....	563
Displaying and changing the operation settings when a group resource error is detected	565
Displaying and changing the script when a group resource activation/deactivation failure is detected	568
Displaying the properties of the whole groups by using the WebManager.....	570
Displaying the properties of a certain group by using the WebManager	571
Understanding server groups	572
Displaying and changing the server group settings	573
Renaming a server group (Server group properties)	573

Displaying and changing the comment of a server group (Server group properties).....	573
Displaying and changing the settings of servers belonging to a server group (Server group properties)	574
Displaying the server group properties with WebManager	575
Understanding application resources	576
Dependency of application resources.....	576
Application resources.....	576
Note on application resources	576
Displaying and changing the application resource details.....	577
Displaying the application resource properties with the WebManager	582
Understanding floating IP resources	585
Dependencies of floating IP resources	585
Floating IP.....	585
Notes on floating IP resources	587
Displaying and changing the details of floating IP resource	588
Displaying the properties of floating IP resource with the WebManager.....	590
Understanding mirror disk resources	592
Dependencies of mirror disk resources	592
Mirror disk	592
Understanding mirror parameters.....	597
Examples of mirror disk construction	600
Notes on mirror disk resources.....	601
Displaying and changing the details of mirror disk resources	602
Tuning mirror disk resource.....	605
Displaying the mirror disk resource properties with the WebManager	607
Notes on operating mirror disk resources.....	609
Understanding registry synchronization resources	610
Dependencies of registry synchronization resources.....	610
Registry synchronization resources.....	610
Notes on registry synchronization resources	611
Displaying and changing the details of registry synchronization resource	612
Tuning registry synchronization resource	614
Displaying the registry synchronization resource properties with the WebManager	615
Understanding script resources	616
Dependencies of script resources	616
Scripts in script resources.....	616
Environment variables in script of script resource	618
Execution timing of script resource scripts	620
Writing scripts.....	636
Tips for creating scripts.....	640
Notes on script resource	640
Displaying and changing the settings of the script resource details	640
Displaying and changing the script resource details.....	640
Displaying and/or changing the script resource script created by the Builder.....	642
Using the simple selection function of a script template	644
Tuning script resource.....	646
Displaying the script resource properties with the WebManager.....	648
Understanding disk resources	650
Dependencies of disk resources	650
Disk resources.....	650
Notes on disk resources.....	651
Displaying and changing the details of disk resources.....	652
Displaying the disk resource properties with the WebManager	653
Understanding service resources.....	655
Dependencies of service resources.....	655
Service resources.....	655
Notes on service resources	655
Displaying and changing the details of service resource	656
Displaying the service resource properties with the WebManager.....	659
Understanding print spooler resources.....	661
Dependencies of print spooler resources.....	661
Print spooler resources	661
Notes on print spooler resources	661
Displaying and changing the details of print spooler resources	663
Displaying the print spooler resource properties with the WebManager.....	664

Understanding virtual computer name resources.....	666
Dependencies of virtual computer name resources.....	666
Virtual computer name resources.....	666
Determining virtual computer name.....	666
Linking virtual computer name and floating IP address.....	667
Configuring WINS server.....	667
Appropriate use of virtual computer name resources and dynamic DNS resources.....	668
Services available to the virtual computer name.....	668
Notes on virtual computer name resources.....	668
Displaying and changing the details of virtual computer name resource.....	672
Displaying the virtual computer name resource properties with the WebManager.....	674
Understanding dynamic DNS resources.....	675
Dependency of dynamic DNS resources.....	675
Dynamic DNS resources.....	676
Appropriate use of virtual computer name resources and dynamic DNS resources.....	677
Preparation for use of dynamic DNS resources.....	677
Notes on dynamic DNS resources.....	677
Displaying and changing the details of dynamic DNS resources.....	678
Displaying dynamic DNS resource properties with the WebManager.....	680
Understanding virtual IP resources.....	682
Dependencies of virtual IP resources.....	682
Virtual IP resources.....	682
Determining virtual IP address.....	684
Controlling path.....	684
Requirement to use virtual IP address.....	685
Notes on virtual IP resources.....	686
Displaying and changing the details of virtual IP resource.....	687
Displaying the virtual IP resource properties with the WebManager.....	694
Understanding CIFS resources.....	696
Dependencies of CIFS resources.....	696
CIFS resources.....	696
Notes on CIFS resources.....	697
Displaying and changing the details of CIFS resources.....	699
Displaying CIFS resource properties with the WebManager.....	703
Understanding NAS resources.....	705
Dependencies of NAS resources.....	705
NAS resources.....	705
Notes on NAS resources.....	705
Displaying and changing NAS resources.....	706
Displaying NAS resource properties with the WebManager.....	707
Understanding hybrid disk resources.....	709
Dependencies of hybrid disk resources.....	709
Hybrid disk.....	709
Notes on hybrid disk resources.....	710
Displaying and changing the details of hybrid disk resource.....	712
Tuning hybrid disk resources.....	714
Displaying hybrid disk resource properties with the WebManager.....	715
Notes on operating hybrid disk resources.....	715
Understanding VM resources.....	718
Dependencies of VM resources.....	718
VM resources.....	718
Notes on VM resources.....	718
Displaying and changing the details of VM resources.....	719
Displaying the VM resource properties with the WebManager.....	721
Understanding AWS elastic ip resources.....	723
Dependencies of AWS elastic ip resources.....	723
What is an AWS elastic ip resource?.....	723
Notes on AWS elastic ip resources.....	724
Applying environment variables to AWS CLI run from the AWS elastic ip resource.....	724
Displaying and changing AWS elastic ip resources details.....	725
Tuning AWS elastic ip resource.....	726
Displaying the AWS elastic ip resource properties with the WebManager.....	727
Understanding AWS virtual ip resources.....	729
Dependencies of AWS virtual ip resources.....	729

What is an AWS virtual ip resource?	729
Notes on AWS virtual ip resources	730
Applying environment variables to AWS CLI run from the AWS virtual ip resource	731
Displaying and changing AWS virtual ip resources details	731
Tuning AWS virtual ip resource	733
Displaying the property of the AWS virtual ip resource with the WebManager	733
Understanding Azure probe port resources	735
Dependencies of Azure probe port resources	735
What is an Azure probe port resource?	735
Notes on Azure probe port resources	736
Displaying and changing the details of Azure probe port resources	737
Tuning Azure probe port resource	738
Displaying the Azure probe port resource properties with the WebManager	738

Chapter 6 Monitor resource details 741

Monitor resources	743
Monitor timing of monitor resources	747
Enabling and disabling Dummy failure of monitor resources	749
Monitoring interval for monitor resources	750
Behavior when an error is detected by a monitor resource	755
Returning from monitor error (Normal)	767
Activation and deactivation error of recovery target when executing recovery operation	771
Recovery/pre-recovery action script	779
Delay warning of monitor resources	783
Waiting for monitor resource to start monitoring	784
Monitor resources that require a license	791
Displaying and changing the settings of a monitor resource (common to monitor resources)	792
Changing the name of a monitor resource	792
Displaying and changing the comment of a monitor resource	792
Displaying and changing the settings of a monitor resource	793
Displaying and changing the settings when an error is detected by a monitor resource	797
Displaying and changing parameters of a monitor resource	803
Understanding application monitor resources	804
Monitoring by application monitor resources	804
Note on application monitor resources	804
Displaying the application monitor resource properties with the WebManager	804
Understanding disk RW monitor resources	806
Monitoring by disk RW monitor resources	806
Displaying and changing disk RW monitor resource details	807
Displaying the disk RW monitor resource properties with the WebManager	809
Understanding floating IP monitor resources	811
Monitoring by floating IP monitor resources	811
Note on floating IP monitor resources	811
Displaying and changing floating IP monitor resource details	812
Displaying the floating IP monitor resource properties with the WebManager	813
Understanding IP monitor resources	815
Monitoring by IP monitor resources	815
Displaying and changing IP monitor resource details	816
Displaying the IP monitor resource properties with the WebManager	818
Understanding mirror connect monitor resources	820
Note on mirror connect monitor resources	820
Displaying and changing the mirror connect monitor resource details - For Replicator -	820
Displaying the mirror connect monitor resource properties with the WebManager	822
Understanding mirror disk monitor resources	824
Note on mirror disk monitor resources	824
Displaying and changing the mirror disk monitor resource details	824
Displaying the mirror disk monitor resource properties with the WebManager	826
Understanding NIC link up/down monitor resources	828
Note on NIC link up/down monitor resources	828
Configuration and range of NIC link up/down monitoring	828
Displaying and changing the NIC link up/down monitor resource details	828
Displaying the NIC link up/down monitor resource properties with the WebManager	830
Understanding multi target monitor resources	832

Note on the multi target monitor resource	832
Multi target monitor resource status	832
Displaying and changing the details of the multi target monitor resource	833
Tuning multi target monitor resource	834
Displaying the properties of the multi target monitor resource with the WebManager	835
Understanding registry synchronization monitor resources.....	837
Note on registry synchronization monitor resources	837
Displaying and changing the details of the registry synchronization monitor resources	837
Displaying the registry synchronization monitor resources properties with the WebManager	837
Understanding disk TUR monitor resources	839
Notes on disk TUR monitor resources.....	839
Displaying and changing the disk TUR monitor resource details.....	840
Displaying the disk TUR monitor resources properties with the WebManager.....	841
Understanding service monitor resources.....	843
Monitoring by service monitor resources	843
Note on service monitor resources.....	843
Displaying and changing the details of the service monitor resources.....	843
Displaying the service monitor resources properties with the WebManager	844
Understanding print spooler monitor resources.....	846
Note on print spooler monitor resources.....	846
Displaying and changing the details of the print spooler monitor resources.....	846
Displaying the print spooler monitor resources properties with the WebManager	846
Understanding virtual computer name monitor resources	848
Monitoring by virtual computer name monitor resources.....	848
Virtual computer name monitor resource	848
Displaying and changing the details of the virtual computer name resources	848
Displaying the virtual computer name monitor resource properties with the WebManager	849
Understanding dynamic DNS monitor resources	851
Notes on dynamic DNS monitor resources.....	851
Displaying and changing the details of the dynamic DNS monitor resource.....	851
Displaying dynamic DNS monitor resource properties with WebManager	852
Understanding virtual IP monitor resources	855
Monitoring by virtual IP monitor resources.....	855
Notes on virtual IP monitor resources	855
Displaying and changing the details of the virtual IP monitor resources	855
Displaying the virtual IP monitor resource properties with the WebManager	855
Understanding CIFS monitor resources.....	857
Monitoring by CIFS monitor resources	857
Notes on CIFS monitor resources.....	857
Displaying and changing the details of CIFS monitor resources	858
Displaying CIFS monitor resource properties with the WebManager	860
Understanding NAS monitor resources	862
Monitoring by NAS monitor resources.....	862
Note on NAS monitor resources	862
Displaying and changing the details of NAS monitor resources.....	862
Displaying NAS monitor resources properties with the WebManager	863
Understanding hybrid disk monitor resources	865
Note on hybrid disk monitor resources.....	865
Displaying and changing the hybrid disk monitor resource details	865
Displaying the hybrid disk monitor resource properties with the WebManager	867
Understanding hybrid disk TUR monitor resources	869
Notes on hybrid disk TUR monitor resources	869
Displaying and changing the hybrid disk TUR monitor resource details.....	869
Displaying the hybrid disk TUR monitor resources properties with the WebManager	871
Understanding custom monitor resources.....	873
Monitoring by custom monitor resources	873
Note on custom monitor resources	873
Displaying and changing the details of the custom monitoring resources	874
Displaying the custom monitor resource properties with the WebManager	876
Understanding message receive monitor resources	878
Monitoring by message receive monitor resources.....	878
Failover to a server group at another site	879
Notes on message receive monitor resources	880
Displaying and changing the details of the Message receive monitor resources.....	881

Displaying the properties of a Message receive monitor resource by using the WebManager.....	882
Understanding VM monitor resources.....	884
Notes on VM monitor resources.....	884
Monitoring by VM monitor resources.....	884
Notes on VM monitor resources.....	884
Displaying the VM monitor resource properties with the WebManager.....	884
Understanding process name monitor resources.....	886
Notes on process name monitor resources.....	886
Monitoring by process name monitor resources.....	887
Displaying and changing the process name monitor resource details.....	888
Displaying the process name monitor resource properties with WebManager.....	889
Understanding DB2 monitor resources.....	891
DB2 monitor resources.....	891
Monitoring by DB2 monitor resources.....	892
Displaying and changing the disk DB2 monitor resource details.....	893
Displaying the DB2 monitor resource properties with the WebManager.....	894
Understanding FTP monitor resources.....	896
FTP monitor resources.....	896
Monitoring by FTP monitor resources.....	896
Displaying and changing the FTP monitor resource details.....	897
Displaying the FTP monitor resource properties with the WebManager.....	898
Understanding HTTP monitor resources.....	900
HTTP monitor resources.....	900
Monitoring by HTTP monitor resources.....	900
Displaying and changing the HTTP monitor resource details.....	901
Displaying the HTTP monitor resource properties with the WebManager.....	902
Understanding IMAP4 monitor resources.....	904
IMAP4 monitor resources.....	904
Monitoring by IMAP4 monitor resources.....	904
Displaying and changing the IMAP4 monitor resource details.....	905
Displaying the IMAP4 monitor resource properties with the WebManager.....	906
Understanding ODBC monitor resources.....	908
ODBC monitor resources.....	908
Monitoring by ODBC monitor resources.....	909
Displaying and changing the ODBC monitor resource details.....	910
Displaying the ODBC monitor resource properties with the WebManager.....	911
Understanding Oracle monitor resources.....	913
Oracle monitor resources.....	913
Monitoring by Oracle monitor resources.....	914
Displaying and changing the Oracle monitor resource details.....	915
Displaying the Oracle monitor resource properties with the WebManager.....	919
Understanding OracleAS monitor resources.....	922
Notes on OracleAS monitor resources.....	922
How OracleAS monitor resources perform monitoring.....	922
Displaying and changing the OracleAS monitor resource details.....	923
Displaying and changing the OracleAS monitor resource properties with the WebManager.....	925
Understanding OfficeScan CL monitor resources.....	927
Notes on OfficeScan CL monitor resources.....	927
How OfficeScan CL monitor resource performs monitoring.....	927
Displaying and changing OfficeScan CL monitor resource details.....	927
Displaying OfficeScan CL monitor resource properties with the WebManager.....	928
Understanding OfficeScan SV monitor resources.....	930
Notes on OfficeScan SV monitor resources.....	930
How OfficeScan SV monitor resource perform monitoring.....	930
Displaying and changing OfficeScan SV monitor resource details.....	930
Displaying OfficeScan SV monitor resource properties with the WebManager.....	930
Understanding POP3 monitor resources.....	932
POP3 monitor resources.....	932
Monitoring by POP3 monitor resources.....	932
Displaying and changing the POP3 monitor resource details.....	933
Displaying the POP3 monitor resource properties with the WebManager.....	934
Understanding PostgreSQL monitor resources.....	936
PostgreSQL monitor resources.....	936
Monitoring by PostgreSQL monitor resources.....	937

Displaying and changing the PostgreSQL monitor resource details	938
Displaying the PostgreSQL monitor resource properties with the WebManager	940
Understanding SMTP monitor resources	943
SMTP monitor resources	943
Monitoring by SMTP monitor resources	943
Displaying and changing the SMTP monitor resource details	944
Displaying the SMTP monitor resource properties with the WebManager	946
Understanding SQL Server monitor resources	948
SQL Server monitor resources	948
Monitoring by SQL Server monitor resources	949
Displaying and changing the SQL Server monitor resource details	950
Displaying the SQL Server monitor resource properties with the WebManager	952
Understanding Tuxedo monitor resources	954
Tuxedo monitor resources	954
Monitoring by Tuxedo monitor resources	954
Displaying and changing the Tuxedo monitor resource details	955
Displaying the Tuxedo monitor resource properties with the WebManager	956
Understanding Websphere monitor resources	958
Websphere monitor resources	958
Monitoring by Websphere monitor resources	958
Displaying and changing the Websphere monitor resource details	958
Displaying the Websphere monitor resource properties with the WebManager	960
Understanding Weblogic monitor resources	963
Weblogic monitor resources	963
Monitoring by Weblogic monitor resources	963
Displaying and changing the Weblogic monitor resource details	964
Displaying the Weblogic monitor resource properties with the WebManager	966
Understanding WebOTX monitor resources	968
WebOTX monitor resources	968
Monitoring by WebOTX monitor resources	968
Displaying and changing the WebOTX monitor resource details Websphere	969
Displaying the WebOTX monitor resource properties with the WebManager	970
Understanding JVM monitor resources	972
Note on JVM monitor resources	972
Monitoring by JVM monitor resources	972
Linking with the load balancer (JVM monitor health check function)	977
Linking with the load balancer (target Java VM load calculation function)	979
Linking with the BIG-IP Local Traffic Manager	982
JVM statistical log	986
Java memory area usage check on monitor target Java VM (jramemory.stat)	986
Thread operation status check on monitor target Java VM (jathread.stat)	987
GC operation status check on monitor target Java VM (jragc.stat)	988
Virtual memory usage check on monitor target Java VM (jruntime.stat)	989
Operation status check on Work Manager of WebLogic Server (wlworkmanager.stat)	989
Operation status check on Thread Pool of WebLogic Server (wlthreadpool.stat)	990
Java memory pool name	990
Executing command corresponding to cause of each detected error	995
Monitoring WebLogic Server	998
Monitoring WebOTX	1000
Monitoring a Java process of the WebOTX domain agent	1000
Monitoring a Java process of a WebOTX process group	1000
Receiving WebOTX notifications	1001
Monitoring Tomcat	1001
Monitoring SVF	1002
Displaying and changing the JVM monitor resource details	1003
Memory tab(when Oracle Java is selected for JVM Type)	1006
Memory tab(when Oracle Java(usage monitoring) is selected for JVM Type)	1008
Thread tab	1011
GC tab	1012
WebLogic tab	1013
Load Balancer Linkage tab	1015
Load Balancer Linkage tab(In case of BIG-IP LTM)	1016
Displaying the JVM monitor resource properties with the WebManager	1017
Understanding system monitor resources	1019

Notes on system monitor resource	1019
Monitoring by system monitor resources	1021
Displaying and changing the system monitor resource details	1025
Displaying the system monitor resource properties with the WebManager	1032
Understanding user space monitor resources	1035
Monitoring by user space monitor resources	1035
Displaying and changing the details of user space monitor resources	1035
Displaying the user space monitor resource properties with the WebManager	1037
Understanding AWS elastic ip monitor resources	1040
Notes on AWS elastic ip monitor resources	1040
Applying environment variables to AWS CLI run from the AWS elastic ip monitor resource	1040
Displaying and changing the details of AWS elastic ip monitor resources	1040
Displaying the AWS elastic ip monitor resource properties with the WebManager	1041
Understanding AWS virtual ip monitor resources	1044
Notes on AWS virtual ip monitor resources	1044
Applying environment variables to AWS CLI run from the AWS virtual ip monitor resource	1044
Displaying and changing the details of AWS virtual ip monitor resources	1044
Displaying the AWS virtual ip monitor resource properties with the WebManager	1046
Understanding AWS AZ monitor resources	1048
Notes on AWS AZ monitor resources	1048
Applying environment variables to AWS CLI run from the AWS AZ monitor resource	1048
Displaying and changing the details of AWS AZ monitor resources	1048
Displaying the AWS AZ monitor resource properties with the WebManager	1049
Understanding Azure probe port monitor resources	1052
Notes on Azure probe port monitor resources	1052
Displaying and changing the Azure probe port monitor resource details	1052
Displaying the Azure probe port monitor resource properties with the WebManager	1053
Understanding Azure load balance monitor resources	1056
Notes on Azure load balance monitor resources	1056
Displaying and changing the Azure load balance monitor resource details	1056
Displaying Azure load balance monitor resource properties with the WebManager	1057
Chapter 7 Heartbeat resources	1059
Heartbeat resources	1060
Understanding kernel mode LAN heartbeat resources	1061
Kernel mode LAN heartbeat resources	1061
Settings of the kernel mode LAN heartbeat resources	1061
Notes on the kernel mode LAN heartbeat resources	1061
Displaying the properties of kernel mode LAN heartbeat resources with the WebManager	1062
Understanding BMC heartbeat resources	1063
Notes on BMC heartbeat resources	1063
Displaying the properties of BMC heartbeat resources with the WebManager	1063
Chapter 8 Details on network partition resolution resources	1065
Network partitions	1066
Understanding the network partition resolution resources	1066
Understanding network partition resolution by COM method	1069
Settings of the COM network partition resolution resources	1069
COM network partition resolution resources	1069
Displaying the properties of COM network partition resolution resources with the WebManager	1070
Understanding network partition resolution by DISK method	1071
Settings of the DISK network partition resolution resources	1071
DISK network partition resolution resources	1072
Displaying the properties of DISK network partition resolution resources with the WebManager	1073
Understanding network partition resolution by PING method	1074
Settings of the PING network partition resolution resources	1074
PING network partition resolution resource	1074
Displaying the properties of PING network partition resolution resources with the WebManager	1075
Understanding network partition resolution by majority method	1076
Settings of the majority network partition resolution resources	1076
Majority network partition resolution resources	1076
Displaying the properties of majority network partition resolution resources with the WebManager	1077

Understanding network partition resolution by COM method and DISK method	1078
Understanding network partition resolution by PING method and DISK method	1078
Not resolving network partition.....	1078
Notes on network partition resolution resource settings.....	1079
Chapter 9 Other monitor settings.....	1081
The forced stop function.....	1082
What is the forced stop function?	1082
Conditions for performing forced stop	1082
Commands to be used for forced stop.....	1083
Displaying and changing the details of forced stop	1083
Notes on the forced stop	1083
Script for forced stop	1085
What is the script for forced stop?	1085
Conditions for executing the script for forced stop.....	1085
Features of the script for forced stop	1085
Displaying and changing the details of the script for forced stop	1085
Notes on the script for forced stop.....	1086
Chassis Identify	1087
What is chassis identify?	1087
Conditions for chassis ID lamp to blink	1087
Behavior of the chassis ID lamp blinking when the cluster stops.....	1087
Commands to be used for chassis identify.....	1088
Displaying and changing the chassis identify details	1088
Notes on chassis identify	1088
Alert Service.....	1089
Alert Service.....	1089
Notes on Alert Service.....	1090
Mail report actions.....	1090
Warning Light status	1090
Operations of SNMP trap sending	1091
Behavior of reporting icon.....	1091
SNMP linkage	1093
SNMP linkage	1093
EXPRESSCLUSTER MIB definitions.....	1093
SNMP trap sending.....	1095
Information acquisition by SNMP.....	1096
MIB objects acquirable with SNMP linkage	1096
Express5800/A1080a or Express5800/A1040a series linkage.....	1099
Express5800/A1080a or Express5800/A1040a series linkage	1099
Notes on Express5800/A1080a or Express5800/A1040a series linkage.....	1099
Creating configuration information for using Express5800/A1080a or Express5800/A1040a series linkage	1100
Express5800/A1080a or Express5800/A1040a series linkage with message receive monitor resources.....	1106
Notes on Express5800/A1080a or Express5800/A1040a series linkage with message receive monitor resources.....	1106
Displaying and changing the details of message receive monitor resources.....	1107
AWS elastic ip resources, AWS virtual ip resources, AWS elastic ip monitor resources, AWS virtual ip monitor resources, AWS AZ monitor resources.....	1108
Azure probe port resources, Azure probe port monitor resources, Azure load balance monitor resources.....	1109
Setting of the Microsoft Azure environment	1109
To the judgment of network partition resolution	1110
For an example of how to configure network partition resolution	1111
Section III Maintenance information.....	1115
Chapter 10 The system maintenance information	1117
Directory structure of EXPRESSCLUSTER	1118
How to delete EXPRESSCLUSTER logs or alerts	1120
Mirror statistics information collection function	1121
What is the mirror statistics information collection function?	1121
Linkage between the mirror statistics information collection function and OS standard functions	1121
Operation of the mirror statistics information collection function	1130

Operation conditions of the mirror statistics information collection function	1131
Notes on the mirror statistics information collection function	1131
Communication ports.....	1132
Limit on the band for mirror connect communication	1134
Procedure for setting a limit on the band for mirror connect communication	1134
Procedure for suspending or releasing the limit on the band for mirror connect communication	1136
What causes EXPRESSCLUSTER to shut down servers	1137
Final action for an error in group resource activation or deactivation	1137
Action for a stall of resource activation or deactivation	1137
Final action at detection of an error in monitor resource.....	1138
Forced stop action	1138
Emergency server shutdown	1138
Resource deactivation error in stopping the EXPRESSCLUSTER Server service	1139
Recovery from network partitioning	1139
Emergency server restart	1139
Failure in resuming the cluster	1139
Configuring the settings to temporarily prevent execution of failover	1140
How to execute chkdsk/defrag.....	1142
How to execute chkdsk/defrag on a shared disk.....	1142
How to execute chkdsk/defrag on a mirror/hybrid disk	1143
How to replace a server with a new one	1145
Wait time for synchronized cluster startup	1146
Changing the server configuration (add/delete).....	1147
Adding a server	1147
Deleting a server	1149
Changing the server IP address.....	1150
When changing the mirror connect IP address is not required	1150
When changing the mirror connect IP address is required	1150
Changing the host name.....	1151
Environment where the mirror disk / hybrid disk does not exist	1151
Environment where the mirror disk / hybrid disk exists.....	1152
Replacing the network card	1153
Changing the disk configuration - For a shared disk -	1154
Replacing the disk.....	1154
Adding a disk	1154
Deleting a disk	1155
Changing the disk configuration - For a mirror disk -	1157
Replacing the disk.....	1157
Adding a disk	1157
Deleting a disk	1158
Backing up/restoring data	1159
Performing a snapshot backup.....	1160
Performing a snapshot backup	1160
Restoring the system disk	1161
Replacing the shared disk	1164
Replacing the mirror disk	1166
Replacing the hybrid disk	1167
Increasing the shared disk size.....	1169
Increasing the mirror disk size.....	1170
Increasing the hybrid disk size.....	1171
Replacing the disk array controller (DAC)/updating the firmware.....	1173
Replacing FibreChannel HBA / SCSI / SAS controller.....	1175
Information required for inquiry	1176
Chapter 11 Troubleshooting.....	1177
Troubleshooting.....	1178
When the EXPRESSCLUSTER system does not start or end.....	1178
When activating or deactivating network partition resolution resource fails	1179
When a network partition resolution resource error is detected	1179
When activating or deactivating group resources fails.....	1180
When a monitor resource error occurs	1180
When a heartbeat timeout occurs	1180

Recovering from failure of one server	1180
Recovering from failure of both servers	1180
When network partitioning occurs	1181
Unavailable commands when interconnections are disconnected.....	1184
Connecting mirror disks/hybrid disks manually	1185
Normally connecting mirror disk when mirroring is available	1185
Forcibly connecting mirror disk when mirroring is not available.....	1185
Recovering from mirror breaks	1186
Automatically recovering from mirroring.....	1187
Checking the mirror break status with a command.....	1188
Checking the mirror recovery progress with a command	1189
Recovering mirror with a command	1190
Running the forcible mirror recovery with a command.....	1190
Running the forcible mirror recovery with a command only on one server.....	1192
Checking the mirror break status from the WebManager	1193
Checking the mirror recovery progress from the WebManager.....	1194
Recovering mirror using the WebManager.....	1196
Running the forcible mirror recovery using the WebManager	1197
Running the forcible mirror recovery from the WebManager only on one server	1198
Media sense function becomes invalid	1198
Chapter 12 Error messages	1199
Messages	1200
Messages during setup.....	1200
Messages reported by event log and alert.....	1201
Driver event log messages.....	1240
Disk filter driver	1240
Kernel mode LAN heartbeat driver	1243
Detailed information in activating and deactivating group resources.....	1244
Application resource.....	1244
CIFS Resource.....	1244
Floating IP resource.....	1245
Mirror disk resource / hybrid disk resource	1246
NAS Resource	1247
Registry synchronization resource.....	1248
Script resource.....	1249
Disk resource	1250
Service resource.....	1251
Print spooler resource	1251
Virtual computer name resource.....	1252
Virtual IP resource.....	1253
Virtual machine resource.....	1253
Dynamic DNS resource	1254
AWS elastic ip resources.....	1255
AWS virtual ip resources.....	1256
Azure probe port resources.....	1257
Detailed information of monitor resource errors	1258
Application monitor resource	1258
CIFS monitor resource.....	1258
DB2 monitor resource	1259
Disk RW monitor resource	1260
Floating IP monitor resource	1262
FTP monitor resource	1263
Custom monitor resource.....	1264
Hybrid disk TUR monitor resource	1264
Hybrid disk monitor resource	1266
HTTP monitor resource	1266
IMAP4 monitor resource	1267
IP monitor resource	1268
Mirror disk monitor resource.....	1268
Mirror connect monitor resource	1269
NIC Link Up/Down monitor resource	1269
Multi target monitor resource	1270
NAS monitor resource	1270

Process name monitor resource	1270
ODBC monitor resource	1271
Oracle monitor resource	1272
OracleAS monitor resource	1273
OfficeScan CL monitor resource	1274
OfficeScan SV monitor resource	1274
POP3 monitor resource	1275
PostgreSQL monitor resource	1276
Registry synchronization monitor resource	1277
Disk TUR monitor resource	1278
Service monitor resource	1279
Print spooler monitor resource	1279
SMTP monitor resource	1279
SQL Server monitor resource	1280
Tuxedo monitor resource	1282
Virtual computer name monitor resource	1282
Virtual IP monitor resource	1283
VM monitor resource	1283
Websphere monitor resource	1283
Weblogic monitor resource	1284
WebOTX monitor resource	1285
JVM monitor resource	1286
System monitor resource	1286
Dynamic DNS monitoring resource	1286
User space monitoring resource	1288
AWS elastic ip monitor resources	1289
AWS virtual ip monitor resources	1289
AWS AZ monitor resources	1290
Azure probe port monitor resource	1290
Azure load balance monitor resource	1291
STOP codes list of disk RW monitor resources	1292
Filter driver STOP code list	1292
JVM monitor resource log output messages	1293
JVM operation log	1293
JVM load balancer linkage log	1303
STOP codes list of user space monitor resources	1305
Appendix	1307
Appendix A Glossary	1309
Appendix B Index	1313

Preface

Who Should Use This Guide

The *EXPRESSCLUSTER X Reference Guide* is intended for system administrators. Detailed information for setting up a cluster system, function of the product, maintenance related information, and how to troubleshoot the problems are covered in this guide. The guide provides supplemental information to the *Installation and Configuration Guide*.

How This Guide is Organized

Section I Detailed functions of EXPRESSCLUSTER

Chapter 1 Functions of the WebManager

Provides information on function of the EXPRESSCLUSTER WebManager.

Chapter 2 Function of the Builder

Provides information on function of the EXPRESSCLUSTER Builder.

Chapter 3 EXPRESSCLUSTER command reference

Provides information on commands available to use in EXPRESSCLUSTER.

Chapter 4 Compatible command reference

Provides information on the commands that are compatible to the commands used in the older versions of EXPRESSCLUSTER.

Section II Resource details

Chapter 5 Group resource details

Provides information on group resource which configures a failover group.

Chapter 6 Monitor resource details

Provides information on monitor resource which works as a monitoring unit in EXPRESSCLUSTER.

Chapter 7 Heartbeat resources

Provides information on heartbeat resource.

Chapter 8 Details of the network partition resolution resource

Provides information on the network partition resolution resource.

Chapter 9 Other monitor settings

Provides information on other monitor settings.

Section III Maintenance information

Chapter 10 The system maintenance information

Provides maintenance information for EXPRESSCLUSTER.

Chapter 11 Troubleshooting

Provides instruction on how to troubleshoot the problem.

Chapter 12 Error messages

Provides explanation on error messages displayed during EXPRESSCLUSTER operation.

Appendix

Appendix A Glossary

Appendix B Index

EXPRESSCLUSTER X Documentation Set

The EXPRESSCLUSTER X manuals consist of the following five guides. The title and purpose of each guide is described below:

Getting Started Guide

This guide is intended for all users. The guide covers topics such as product overview, system requirements, and known problems.

Installation and Configuration Guide

This guide is intended for system engineers and administrators who want to build, operate, and maintain a cluster system. Instructions for designing, installing, and configuring a cluster system with EXPRESSCLUSTER are covered in this guide.

Reference Guide

This guide is intended for system administrators. The guide covers topics such as how to operate EXPRESSCLUSTER, function of each module, maintenance-related information, and troubleshooting. The guide is supplement to the *Installation and Configuration Guide*.

Integrated WebManager Administrator's Guide

This guide is intended for system administrators who manage a cluster system using EXPRESSCLUSTER with the Integrated WebManager and for system engineers introducing the Integrated WebManager. Details on the actual procedures required when introducing a cluster system using the Integrated WebManager are described in this guide.

WebManager Mobile Administrator's Guide

This guide is intended for system administrators who manage a cluster system using EXPRESSCLUSTER with WebManager Mobile, and for system engineers who are introducing WebManager Mobile. Details on the actual procedures required when introducing a cluster system using WebManager Mobile are described in this guide.

Conventions

In this guide, **Note**, **Important**, **Related Information** are used as follows:

Note:

Used when the information given is important, but not related to the data loss and damage to the system and machine.

Important:

Used when the information given is necessary to avoid the data loss and damage to the system and machine.

Related Information:

Used to describe the location of the information given at the reference destination.

The following conventions are used in this guide.

Convention	Usage	Example
Bold	Indicates graphical objects, such as fields, list boxes, menu selections, buttons, labels, icons, etc.	In User Name , type your name. On the File menu, click Open Database .
Angled bracket within the command line	Indicates that the value specified inside of the angled bracket can be omitted.	<code>clpstat -s[-h <i>host_name</i>]</code>
Monospace (courier)	Indicates path names, commands, system output (message, prompt, etc.), directory, file names, functions and parameters.	<code>c:\Program files\EXPRESSCLUSTER</code>
Monospace bold (courier)	Indicates the value that a user actually enters from a command line.	Enter the following: <code>clpcl -s -a</code>
<i>Monospace italic</i> (courier)	Indicates that users should replace italicized part with values that they are actually working with.	<code>clpstat -s [-h <i>host_name</i>]</code>

Contacting NEC

For the latest product information, visit our website below:

<http://www.nec.com/global/prod/expresscluster/>

Section I Detailed functions of EXPRESSCLUSTER

This section explains the details of EXPRESSCLUSTER functions. Specifically, the function of the EXPRESSCLUSTER X WebManager and the Builder is described. It also gives the description of the available commands on EXPRESSCLUSTER.

- Chapter 1 Functions of the WebManager
- Chapter 2 Function of the Builder
- Chapter 3 EXPRESSCLUSTER command reference
- Chapter 4 Compatible command reference

Chapter 1 Functions of the WebManager

This chapter describes the functions of the WebManager.

This chapter covers:

• Window of the WebManager	28
• Checking the status of each object in the tree view of WebManager	41
• Checking the cluster status by the WebManager list view	72
• Checking alerts using the WebManager	80
• Mirror disk helper.....	83
• Manually stopping and starting the WebManager.....	95
• When you do not want to use the WebManager.....	95
• Setting limitations on the connection and operation of the WebManager	95
• Operating a cluster by using the WebManager	98
• Limitations of the WebManager.....	99
• Error messages on the WebManager.....	100

Window of the WebManager

This chapter provides information about the WebManager window.

Note:

For the language used on the WebManager screen, see “Cluster properties Info tab.”

Main window of the WebManager

The WebManager window consists of two bars and three views.

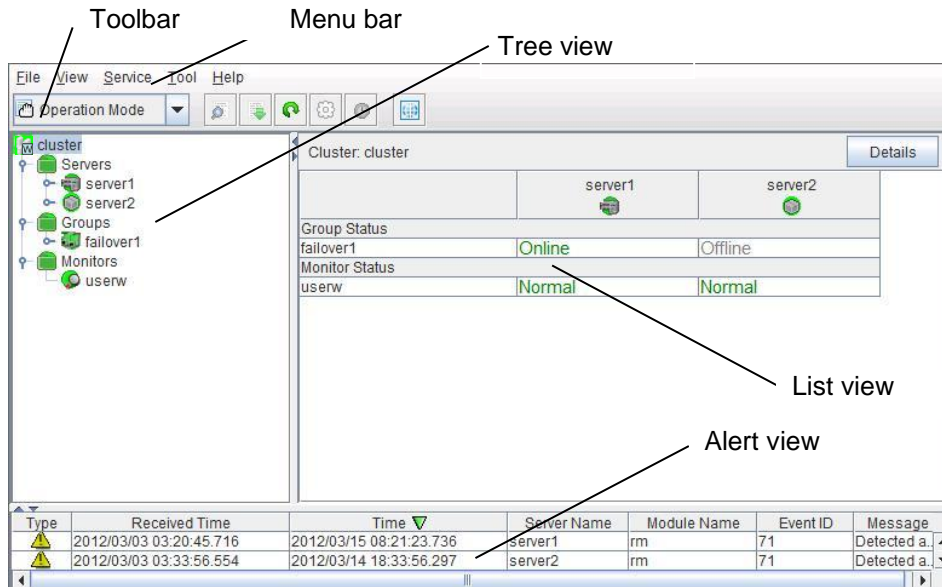





Menu bar

The menu bar has the five menus described below. The contents of these menus differ depending on the config mode and operation/reference mode. The menu items displayed in the operation/reference mode are described later in this chapter. For details about the menus displayed in the config mode, see the next chapter.

- ◆ **File** menu
- ◆ **View** menu
- ◆ **Service** menu
- ◆ **Tool** menu
- ◆ **Help** menu

Toolbar

If you click one of the five icons or the drop-down menu on the toolbar, you can perform the same operation as when selecting the corresponding item on the menu bar.

Icon/menu	Description	Refer to:
 Operation Mode	Changes the WebManager to the operation mode. This is the same as clicking View on the menu bar and then selecting Operate Mode .	Changing the WebManager operation mode (Page 30)
 Config Mode	Changes the WebManager to the config mode (online version of the Builder). This is the same as clicking View on the menu bar and then selecting Config Mode .	Changing the WebManager operation mode (Page 30)
 Reference Mode	Changes the WebManager to the reference mode. This is the same as clicking View on the menu bar and then selecting Reference Mode .	Changing the WebManager operation mode (Page 30)
 Verification mode	Changes the WebManager to the verification mode. This is the same as clicking View on the menu bar and then selecting Verification mode .	Changing the WebManager operation mode (Page 30)
	Searches for an alert. This is the same as clicking Tool on the menu bar and then selecting Alert Search .	Searching for an alert by using the WebManager (Page 31)
	Collects logs. This is the same as clicking Tool on the menu bar and then selecting Collect Cluster Logs .	Collecting logs by using the WebManager (Page 34)
	Performs reloading. This is the same as clicking Tool on the menu bar and then selecting Reload .	Updating the WebManager information (Page 36)
	Displays the option. This is the same as clicking Tool on the menu bar and then selecting Option .	Changing the WebManager screen layout (Page 37)
 	Displays the time information. This is the same as clicking Tool on the menu bar and then selecting TimeInfo . When the time information has been updated, the icon changes accordingly. The icon reverts to its original form when the time information dialog is displayed.	Checking the time information from the WebManager (Page 37)
	Displays Integrated WebManager. This is the same as clicking Tool on the menu bar and then selecting Integrated WebManager .	Executing Integrated WebManager from the WebManager (Page 39)

Tree view

Allows you to see a status of each cluster's resources such as server and group resources. For more information, refer to "Checking the status of each object in the tree view of WebManager" on page 41.

List view

The upper part of the view provides information on each cluster resource selected in the tree view. The lower part lists the start/stop statuses and comments of each server, group resource, and monitor resource. If you click **Details** located on the upper right of the view, further information will be displayed in a dialog. For more information, see "Checking the cluster status by the WebManager list view" on page 72.

Alert view

Shows messages describing EXPRESSCLUSTER operating status. For further information, see "Checking alerts using the WebManager" on page 80.

Changing the WebManager operation mode

The WebManager has the following four operation modes.

- ◆ Operation mode
This mode allows the user to see the status of and operate the cluster.
Select **Operate Mode** on the **View** menu or the toolbar to switch to the operation mode.
However, if you used the reference mode password for login when starting the WebManager or connected to the WebManager from a client that is not allowed to perform operations, it is not possible to switch to the operation mode.
- ◆ Reference mode
This mode allows the user to see the cluster status, but not to operate the cluster.
Select **Reference Mode** on the **View** menu or the toolbar to switch to the operation mode.
- ◆ Config mode
This mode allows the user to set up the cluster and change the settings. The WebManager in the config mode is called Builder (online version). For details about operations in the config mode, see the next chapter. Select **Config Mode** on the **View** menu or the toolbar to switch to the **Config Mode**. However, if you connected to the WebManager from a client that is not allowed to perform operations, it is not possible to switch to the **Config Mode**.
- ◆ Verification mode
This mode allows the user to generate a simulated fault in specified monitor resources.
Select **Verification mode** on the **View** menu or the toolbar to switch to the **Verification mode**. However, if you connected to the WebManager from a client that is not allowed to perform operations, it is not possible to switch to verification mode.
If you switch from the verification mode to another mode, a dialog box asks if you want to cancel the simulated fault status of all the monitor resources. Select **Yes** to place all the monitor resources in the simulated fault status back in the normal monitored status. Select **No** to switch to another mode while keeping the monitor resources in the simulated fault status.

Note: When the pop-up window is displayed for **Operation Mode**, **Reference Mode**, or **Verification Mode** in the WebManager, and if switching to **Config Mode** is performed, the open pop-up window closes.

The operation performed on the pop-up window continues.

Searching for an alert by using the WebManager

You can search for an alert by using the WebManager. Searching in this method is useful to view only a specific type alert.

Note:

For the information on alert logs, see “Checking alerts using the WebManager” on page 80.

To search for an alert, click on the **Tool** menu or click the alert search icon () on the toolbar. The window for specifying alert log search conditions is displayed.

To search only the specified number of past alert logs:

1. Select **Display only the specified number of alerts.**
2. Enter the number of past alert logs to search, and click **OK**. Past alert logs are displayed as many as you have specified.

Note:

The maximum value to enter is the number configured in **Max Number to Save Alert Records**. To configure **Max Number to Save Alert Records**, right-click the cluster icon in the Builder and click **Properties** on the shortcut menu. In the properties dialog box click the **Alert Log** tab.

To search by specifying search conditions:

1. Click **Select the filter option.**
2. Enter the search conditions in each field and start searching.

Alert Type: Select the type of alerts.

Module Name: Enter the module type.

The values you can enter are as follows.

Module Name	Category
pm	Whole EXPRESSCLUSTER
rc	Group/resource related
rm	Monitor resource related
nm	Heartbeat resource related
lankhb	Kernel mode LAN heartbeat resource
bmchb	BMC heartbeat resource
disknp	DISK network partition resolution resource

Module Name	Category
fip	Floating IP resource
vcom	Virtual computer name resource
ddns	Dynamic DNS resources
ddnsw	Dynamic DNS monitor resources
vip	Virtual IP resource
cifs	CIFS resource
diskw	Disk RW monitor resource
sdw	Disk TUR monitor resource
hdtw	Hybrid disk TUR monitor resource
db2	DB2 monitor resources
db2w	DB2 monitor resources
ftp	FTP monitor resources
ftpw	FTP monitor resources
http	HTTP monitor resources
httpw	HTTP monitor resources
imap4	IMAP4 monitor resources
imap4w	IMAP4 monitor resources
odbc	ODBC monitor resources
odbcw	ODBC monitor resources
oracle	Oracle monitor resources
oraclew	Oracle monitor resources
oracleas	OracleAS monitor resources
oracleasw	OracleAS monitor resources
oss	OfficeScan SV monitor resources
ossw	OfficeScan SV monitor resources
otx	WebOTX monitor resource
otxw	WebOTX monitor resource
pop3	POP3 monitor resources
pop3w	POP3 monitor resources
psql	PostgreSQL monitor resources
psqlw	PostgreSQL monitor resources
smtp	SMTP monitor resources
smtpw	SMTP monitor resources
sqlserver	SQL Server monitor resources
sqlserverw	SQL Server monitor resources
tux	Tuxedo monitor resources
tuxw	Tuxedo monitor resources
was	Websphere monitor resources
wasw	Websphere monitor resources

Module Name	Category
wls	Weblogic monitor resources
wlsw	Weblogic monitor resources
jra	JVM monitor resources
jraw	JVM monitor resources
sraw	System monitor resources
psw	Process name monitor resources
diskperf	Disk performance information management module
diskagent	Disk agent monitor resource
sdfunc	Disk function related
mdadm	Mirror disk related
hdadm	Hybrid disk related
armcmd	Compatible commands
event	Event log
lcns	License related
logcmd	Message output command
ptun	Parameter tuning related
lamp	Network warning light alert related
mail	Mail alert related
userw	User space monitor resources

Server Name Type in the name of a server whose alerts you want to see.

Event ID Type in an event ID whose alerts you want to see.
For more information on the event ID, refer to Chapter 12, "Error messages" in this guide.

Start Time, Stop Time: Specify the Start Time and Stop Time to narrow down the search condition using the time of the event occurrence.

3. Enter the number of alerts to display on one page in **The number of alerts to be displayed per page** and click **OK**. Research results are displayed based on the time an alert occurred.
4. If the results of research are displayed on more than one page, move the page by clicking **Back**, **Next**, and **Jump**.

Collecting logs by using the WebManager

Clicking **Collect Cluster Logs** on the **Tool** menu or clicking the **Collect Cluster Logs** icon () on the toolbar opens the log collection dialog box.

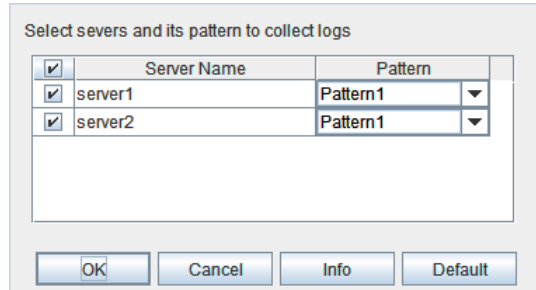

Check box

Select check boxes of the servers that have the logs you want to collect.

Pattern

Select the information to be collected. Specify one of Type 1 to Type 4 as the log collection pattern.

	Type 1	Type 2	Type 3	Type 4
(1) Default collection information	✓	✓	✓	--
(2) Event log	✓	✓	✓	✓
(3) Watson log	✓	✓	✓	✓
(4) User dump	✓	✓	-	-
(5) Diagnosis program report	✓	✓	-	-
(6) Registry	✓	✓	✓	-
(7) Script	✓	✓	✓	-
(8) Logs of ESM/PRO/AC and ESM/PRO/UPSC	✓	✓	✓	-
(9) Logs of HA	-	✓	-	-

For detailed information of (1) to (9), see “Collecting logs (clplogcc command)” in Chapter 3, “EXPRESSCLUSTER command reference” on page 357.

OK

Starts log collection and displays the dialog box of log collection progress.

Cancel

Closes this dialog box.

Info

Displays the information for each pattern.

Default

Resets the selections of servers and collect patterns to default values.

Server Name	IP Address	Status	Progress	Result
server1	10.0.0.1	Compressing	<div style="width: 7%; height: 10px; background-color: blue;"></div> 7%	Normal
server2	10.0.0.2	Compressing	<div style="width: 7%; height: 10px; background-color: blue;"></div> 7%	Normal

The dialog box of the log collection progress

Update

Updates the dialog box of the log collection progress.

Abort

Aborts the log collection.

Close

Closes the **Log Collection Progress** dialog box. Log collection is continued.

At this time, the display of **Collect Logs** in title view has changed to **Progress**. Click **Progress** to display the **Log Collection Progress** dialog box again.

Collect Logs Results

Result	Description
Normal	Log collection succeeded.
Abort	Log collection was canceled by user.
Invalid Parameters	Internal error may have occurred.
Communication Error	Connecting error occurred.
Timeout	Timeout occurred.
Busy	Server is busy.
Compression Error	Error occurred when compressing a file.
File I/O Error	File I/O failed.
Not Enough Free Space	There is not enough available space on the disk.
Unknown Error	File does not exist.

When the log collection completes, the browser displays a dialog box that asks where you want to save the logs. Download the logs to any location.

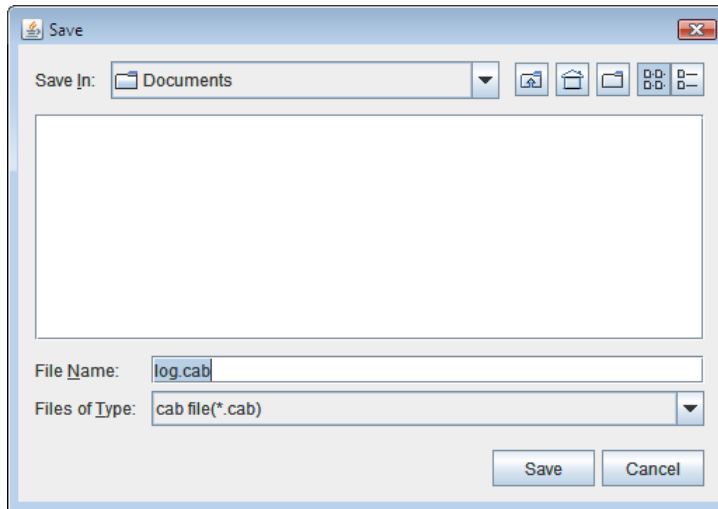

Note:

Logs may not be downloaded properly if nothing is changed for more than 10 minutes.

Note:

If other modal dialog is displayed while collecting logs, the file saving dialog for the log collection will not be displayed. To display the file saving dialog, close the modal dialog.

Note:

If the size of the log file exceeds 2 GB, log collection may fail depending on the compression format. Adjust the log to be collected or change the log collection pattern.

Updating the WebManager information

Click **Reload** on the **Tool** menu or click the reload icon () on the toolbar to update the information displayed in the WebManager.

Note:

If the client data update method of the WebManager is set to **Polling**, the information displayed in the WebManager is regularly updated and the latest status is not immediately displayed even if the status has changed. To display the latest information, click the **Reload** icon or **Reload** in the **Tool** menu after performing an operation.

To configure the automatic reload interval of the WebManager, Open **Cluster Properties** dialog box - **WebManager** tab. Click **Tuning** button and configure the **Reload Interval**.



Some objects may be displayed in gray when communications to the connecting destination is disabled or EXPRESSCLUSTER is not working at the access destination.

Changing the WebManager screen layout

The screen layout of the WebManager can be changed by clicking the split bars or by dragging the bars.

The split bars divide the views in the WebManager.



On the bar, click  to maximize the view. Click  to minimize.

To change the display items on the tree view, click **Option** on the **Tool** menu or option icon () on the tool bar.

The following dialog is displayed. Check items you want to display.

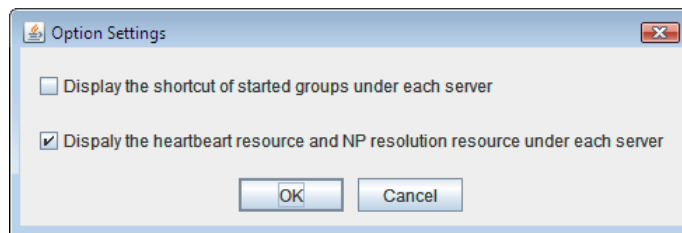

Checking the time information from the WebManager

Check the time information from the WebManager by clicking **Time info** on the **Tool** menu or by clicking the time information icon () on the toolbar.

Time information displayed on the Server tab

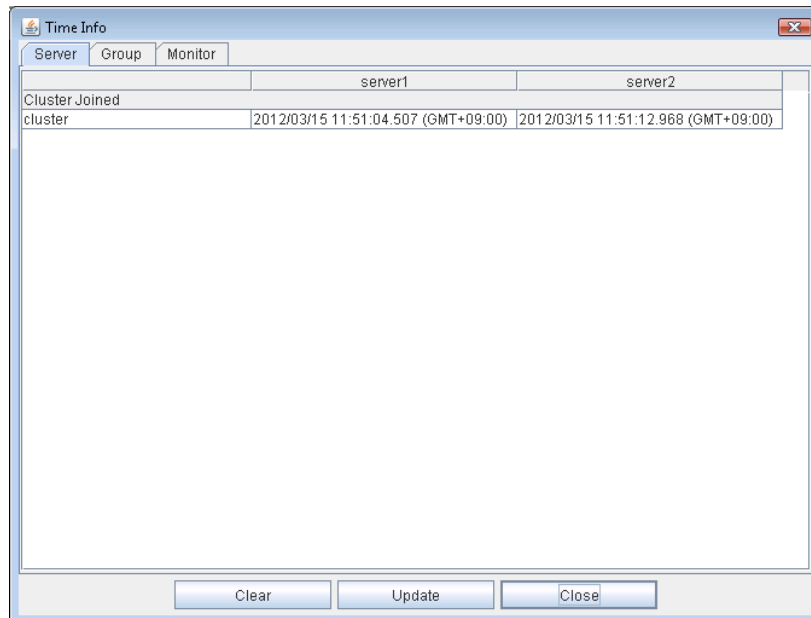

- ◆ Cluster joined
Displays the most recent time at which each server joined the cluster.

Time information displayed on the Group tab

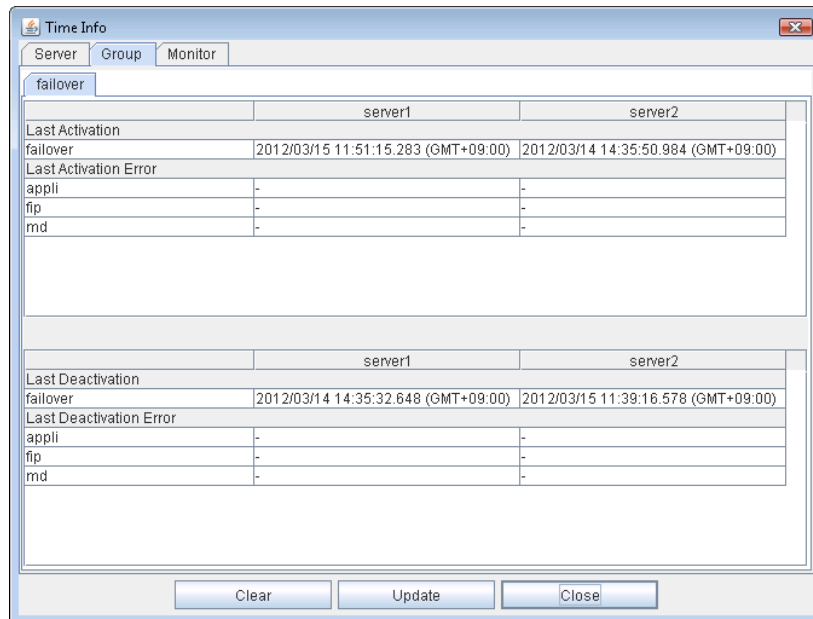

- ◆ Last activation
Displays the time at which the failover group was last activated on each server.
- ◆ Last activation error
Displays the time at which an activation failure of a group resource was last detected on each server.
- ◆ Last deactivation
Displays the time at which the failover group was last deactivated on each server.
- ◆ Last deactivation error
Displays the time at which a deactivation failure of a group resource was last detected on each server.

Time information displayed on the Monitor tab

	server1	server2
Last Error Detection		
appliw1	2012/03/15 11:57:15.324 (GMT+09:00)	-
fipw1	-	-
mdnw1	-	-
mdw1	-	-

- ◆ Last error detection
Displays the time at which each monitor resource last transitioned from normal status to abnormal status on each server.

Note:

Message receive monitor resources is not dealing.

Clear

Deletes the time information displayed on the current tab.

Update

Acquires the time information for all the tabs.

Close

Closes the time information dialog box.

Note:

If the Client Data Update Method of the WebManager is set to Polling, when clear button was pushed, Lighting up Time info on the Tool menu. But it's no problem as cluster.

Executing Integrated WebManager from the WebManager

To execute Integrated WebManager from the WebManager, click **Integrated WebManager** on the **Tool** menu or Integrated WebManager icon () on the tool bar.

Operating a cluster and cluster services on the WebManager

To operate cluster services on the WebManager, select the relevant items below from the **Service** menu.

- ◆ **Suspend Cluster**
Suspends a cluster. This menu can be selected only when all the servers in a cluster are running. Upon the completion of **Suspend Cluster**, **Suspend** appears in the tree view of WebManager.
- ◆ **Resume Cluster**
Resumes a suspended cluster. This menu can be selected only when all the servers in a cluster are suspended.
- ◆ **Start Cluster**
Starts a cluster. This menu can be selected only when a cluster is stopped.
- ◆ **Stop Cluster**
Stops a cluster. This menu can be selected only when a cluster is running. Upon the completion of **Stop Cluster**, **Stop** appears in the tree view of WebManager.
- ◆ **Restart Manager**
Restarts a manager.

Confirming the license from the WebManager

To confirm the license from the WebManager, click **License Information** on the **Help** menu.

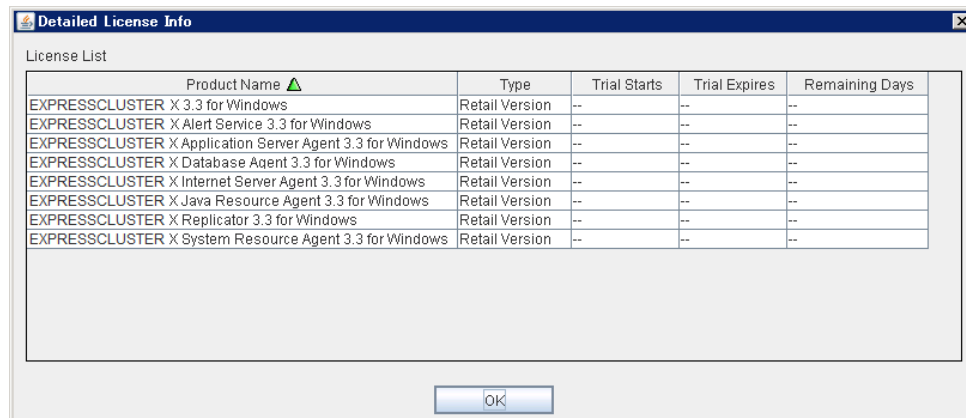

License List

Displays the licenses registered on the connection destination server.

You can change the display order by selecting a specific field name on the title bar of the list.

By default, the licenses are sorted in ascending order of **Product Name**.

OK button

Closes the **Detailed License Info** dialog box.

Checking the status of each object in the tree view of WebManager

You can see the status of the objects that configure the cluster on the WebManager by following the steps below.

1. Start the WebManager. (http://Management IP address or cluster server IP address:port_number (default value is 29003))
2. On the left pane of the window, a tree is displayed. Check the status by looking at each icon and object color.



















Note:

The configurations of the tree depend on the versions and option products of EXPRESSCLUSTER.























The colors of the icons displayed in the WebManager tree view





















The following table shows icons and their meanings:























No.	Icon	Status	Description
(1)		Normal	All servers, group resources, and monitor resources are in a normal status.
		Warning	One or more servers, or group resources, or monitor resource has an error or is in a warning status.
		Error	All servers are down or in the error status.
(2)		Normal	All servers have been started.
		Warning	One or more servers is down or in the pending status.
		Unknown	No information is acquired.
(3)		Online	The server is running normally.
		Suspension (Network Partition Unsolved)	The network partition cannot be solved, because the disk network partition resolution resource is in the error status.
		Suspension (Isolated)	The server has been rebooted after it was shut down a way other than Suspend Cluster or a cluster shutdown.
		Offline or Unknown	The server is not working, or no information is acquired.





















No.	Icon	Status	Description	
(4)	Individual server (Virtual machine)		Online	The server is running normally.
			Suspension (Network Partition Unsolved)	The network partition cannot be solved, because the disk network partition resolution resource is in the error status.
			Suspension (Isolated)	The server has been rebooted after it was shut down a way other than Suspend Cluster or a cluster shutdown.
			Offline or Unknown	The server is not working, or no information is acquired.
(5)	Kernel-mode LAN heartbeat resource		Normal	The resource can communicate with all servers.
			Warning	One or more servers in the cluster cannot be accessed.
			Error	The resource is not working normally.
			Unknown	No status is acquired.
			Not Used	The heartbeat resource is not registered.
(6)	BMC heartbeat resource		Normal	The resource can communicate with all servers.
			Warning	One or more servers in the cluster cannot be accessed.
			Error	The resource is not working normally.
			Unknown	No status is acquired.
			Not Used	The heartbeat resource is not registered.
(7)	Disk network partition resolution resource		Normal	The resource can communicate with all servers.
			Warning	One or more servers in the cluster cannot be accessed.
			Error	The resource is not working normally.
			Unknown	No status is acquired.
			Not Used	The disk network partition resolution resource is not registered.

Checking the status of each object in the tree view of WebManager



















No.	Icon	Status	Description	
(8)	COM network partition resolution resource		Normal	The resource can communicate with all servers.
			Warning	One or more servers in the cluster cannot be accessed.
			Error	The resource is not working normally.
			Unknown	No status is acquired.
			Not Used	The network partition resolution resource is not registered.
(9)	PING network partition resolution resource		Normal	The resource can communicate with all servers.
			Warning	One or more servers in the cluster cannot be accessed.
			Error	The resource is not working normally.
			Unknown	No status is acquired.
			Not Used	The PING network partition resolution resource is not registered.
(10)	Majority Network Partition Resolution Resource		Normal	The resource can communicate with all servers.
			Warning	One or more servers in the cluster cannot be accessed.
			Error	The resource is not working normally.
			Unknown	No status is acquired.
			Not Used	The Majority Network Partition Resolution Resource is not registered.
(11)	All groups		Normal	All groups are running normally.
			Warning	One or more groups are not running normally.
			Error	No groups are working normally.
			Unknown	No information is acquired.
(12)	Individual group		Online	The group has been started.
			Error	The group has an error.
			Offline or Unknown	The group is stopped, or no information is acquired.

No.	Icon	Status	Description
(13)		Online	The application resource has been started.
			The application resource has an error.
			The application resource is stopped, or no information is acquired.
(14)		Online	The floating IP resource has been started.
			The floating IP resource has an error.
			The floating IP resource is stopped/ no information is acquired.
(15)		Online	The mirror disk resource has been started.
			The mirror disk resource has an error.
			The mirror disk resource is stopped, or no information is acquired.
(16)		Online	The registry synchronization resource has been started.
			The registry synchronization resource has an error.
			The registry synchronization resource is stopped, or no information is acquired.
(17)		Online	The script resource has been started.
			The script resource has an error.
			The script resource is stopped, or no information is acquired.
(18)		Online	The disk resource has been started.
			The disk resource has an error.
			The disk resource is stopped, or no information is acquired.
(19)		Online	The service resource has been started.
			The service resource has an error.
			The service resource is stopped, or no information is acquired.



















No.	Icon	Status	Description
(20)		Online	The print spooler resource has been started.
			Error
			Offline or Unknown
(21)		Online	The virtual computer name resource has been started.
			Error
			Offline or Unknown
(22)		Online	The virtual IP resource has been started.
			Error
			Offline or Unknown
(23)		Online	The CIFS resource has been started.
			Error
			Offline or Unknown
(24)		Online	The NAS resource has been started.
			Error
			Offline or Unknown
(25)		Online	The hybrid disk resource has been started.
			Error
			Offline or Unknown
(26)		Online	The virtual machine resource has been started.
			Error
			Offline or Unknown
(27)		Online	The dynamic DNS resource has been started.

No.	Icon	Status	Description
	resource		Error The dynamic DNS resource has an error.
			Offline or Unknown The dynamic DNS resource is stopped, or no information is acquired.
(28)	AWS elastic ip resource		Normal The AWS elastic ip resource is running normally.
			Error The AWS elastic ip resource has an error.
			Offline or Unknown The AWS elastic ip resource is stopped, or no information is acquired.
(29)	AWS virtual ip resource		Normal The AWS virtual ip resource is running normally.
			Error The AWS virtual ip resource has an error.
			Offline or Unknown The AWS virtual ip resource is stopped, or no information is acquired.
(30)	Azure probe port resource		Normal The Azure probe port resource is running normally.
			Error The Azure probe port resource has an error.
			Offline or Unknown The Azure probe port resource is stopped, or no information is acquired.
(31)	All monitor resources ¹		Normal All monitor resources are running normally.
			Warning One or more monitor resources have an error, or monitoring is suspended on a server.
			Error All monitor resources have errors.
			Normal (Dummy Failure) In the normal status, dummy failure enabled.
			Warning (Dummy Failure) In the warning status, dummy failure enabled.
			Error (Dummy Failure) In the error status, dummy failure enabled.
			Normal (Recovery Action Disabled) In the normal status, the recovery action is inhibited.
			Warning (Recovery Action Disabled) In the warning status, the recovery action disabled.
	Error (Recovery Action Disabled) In the error status, the recovery action disabled.		





















¹ If recovery action triggered by monitor resource error is disabled, "Recovery Action Disabled" is indicated next to the monitor. If a monitor resource for which a dummy failure occurred exists, "Failure Verification" is indicated.





















No.	Icon	Status	Description	
		Normal (Dummy Failure and Recovery Action Disabled)	In the normal status, the recovery action disabled and dummy failure enabled.	
		Warning (Dummy Failure and Recovery Action Disabled)	In the warning status, the recovery action disabled and dummy failure enabled.	
		Error (Dummy Failure and Recovery Action Disabled)	In the error status, the recovery action disabled and dummy failure enabled.	
		Unknown	No information is acquired.	
(32)	Application monitor resource ²		Normal	The application is running normally.
		Warning	There are one or more servers with application problems, or monitoring is suspended on a server.	
		Error	All servers have application errors.	
		Dummy Failure	Dummy Failure is enabled.	
		Unknown	No information is acquired.	
(33)	Disk RW monitor resource ²		Normal	The disk is running normally.
		Warning	There are one or more servers with disk problems, or monitoring is suspended on a server.	
		Error	All servers have disk errors.	
		Dummy Failure	Dummy Failure is enabled.	
		Unknown	No information is acquired.	
(34)	Floating IP monitor resource ²		Normal	The floating IP address has no error.
		Warning	One or more servers cannot communicate with the floating IP address, or monitoring is suspended on a server.	
		Error	No servers can communicate with the floating IP address.	
		Dummy Failure	Dummy Failure is enabled.	



















² If a dummy failure has occurred, "Dummy Failure" is indicated.
Section I Detailed functions of EXPRESSCLUSTER























No.	Icon	Status	Description	
		Unknown	No information is acquired.	
(35)	IP monitor resource ²		Normal	The IP address of a target has no error.
			Warning	One or more servers cannot communicate with the IP address of the target, or monitoring is suspended on a server.
			Error	No servers can communicate with the IP address of the target.
			Dummy Failure	Dummy Failure is enabled.
			Unknown	No information is acquired.
(36)	Mirror connect monitor resource		Normal	The mirror connect is running normally.
			Warning	One of the servers has mirror connect problems, or monitoring is suspended on a server.
			Error	A mirror connect error has occurred on both servers.
			Unknown	No information is acquired.
(37)	Mirror disk monitor resource		Normal	The mirror disk is running normally.
			Warning	Mirroring is now being recovered, or monitoring is suspended on a server.
			Error	The mirror disk has an error. Mirror recovery is needed.
			Unknown	No information is acquired.
(38)	NIC Link Up/Down monitor resource ²		Normal	The NIC of a target has no error.
			Warning	One of servers has a problem with the NIC of the target, or monitoring is suspended on a server.
			Error	All servers have errors with the NIC of the target.
			Dummy Failure	Dummy Failure is enabled.
			Unknown	No information is acquired.





















Checking the status of each object in the tree view of WebManager





















No.	Icon	Status	Description	
(39)		Normal	Multi target monitor resource is running normally.	
			Warning	Monitoring is suspended on a server, or one or more monitor resources registered in the multi target monitor resource have errors.
			Error	Multi target has an error.
			Dummy Failure	Dummy Failure is enabled.
			Unknown	No information is acquired.
(40)		Normal	The registry synchronization is running normally.	
			Warning	Monitoring is suspended on a server.
			Error	The registry synchronization has an error.
			Dummy Failure	Dummy Failure is enabled.
			Unknown	No information is acquired.
(41)		Normal	The disk is running normally.	
			Warning	There are one or more servers with disk problems, or monitoring is suspended on a server.
			Error	All the servers have disk errors.
			Dummy Failure	Dummy Failure is enabled.
			Unknown	No information is acquired.
(42)		Normal	The service is running normally.	
			Warning	Monitoring is suspended on a server.
			Error	The service has an error.
			Dummy Failure	Dummy Failure is enabled.
			Unknown	No information is acquired.





















No.	Icon	Status	Description	
(43)	Print spooler monitor resource ²		Normal	The print spooler monitor is running normally.
			Warning	Monitoring is suspended on a server.
			Error	The print spooler has an error.
			Dummy Failure	Dummy Failure is enabled.
			Unknown	No information is acquired.
(44)	Virtual computer name monitor resource ²		Normal	The virtual computer name is running normally.
			Warning	Monitoring is suspended on a server.
			Error	The virtual computer name has an error.
			Dummy Failure	Dummy Failure is enabled.
			Unknown	No information is acquired.
(45)	Virtual IP monitor resource ²		Normal	The virtual IP is running normally.
			Warning	Monitoring is suspended on a server.
			Error	The virtual IP has an error.
			Dummy Failure	Dummy Failure is enabled.
			Unknown	No information is acquired.
(46)	CIFS monitor resource ²		Normal	The CIFS is working normally.
			Warning	Monitoring is suspended on a server.
			Error	The CIFS has an error.
			Dummy Failure	Dummy Failure is enabled.
			Unknown	No information is acquired.





















No.	Icon	Status	Description	
(47)	NAS monitor resource ²		Normal	The NAS is working normally.
			Warning	Monitoring is suspended on a server.
			Error	The NAS has an error.
			Dummy Failure	Dummy Failure is enabled.
			Unknown	No information is acquired.
(48)	Hybrid disk monitor resource		Normal	The Hybrid disk is working normally.
			Warning	Mirroring is now being recovered, or monitoring is suspended on a server.
			Error	The hybrid disk has an error. Mirror recovery is needed.
			Unknown	No information is acquired.
(49)	Hybrid disk TUR monitor resource ²		Normal	The disk is working normally.
			Warning	One of servers has a problem with the disk, or monitoring is suspended on a server.
			Error	All the servers have disk errors.
			Dummy Failure	Dummy Failure is enabled.
			Unknown	No information is acquired.
(50)	Custom monitor resource ²		Normal	No error is detected by monitor script.
			Warning	There is a server where monitoring is suspended, or an error has been detected in one of the servers.
			Error	Monitor script has detected an error.
			Dummy Failure	Dummy Failure is enabled.
			Unknown	No information is acquired.

























No.	Icon	Status	Description	
(51)	VM monitor resource		Normal	The VM is running normally.
			Warning	The virtual machine is not working on one or more servers, or monitoring is suspended on a server.
			Error	The VM has an error.
			Unknown	No information is acquired.
(52)	Message receive monitor resource		Normal	No error message has been received.
			Warning	Change to “A server has received an error message, or monitoring is suspended on a server.”
			Error	An error message has been received.
			Unknown	No information is acquired.
(53)	DB2 monitor resource ²		Normal	The DB2 is working normally.
			Warning	Monitoring is suspended on a server.
			Error	The DB2 has an error.
			Dummy Failure	Dummy Failure is enabled.
			Unknown	No information is acquired.
(54)	FTP monitor resource ²		Normal	The FTP is running normally.
			Warning	Monitoring is suspended on a server.
			Error	The FTP has an error.
			Dummy Failure	Dummy Failure is enabled.
			Unknown	No information is acquired.
(55)	HTTP monitor resource ²		Normal	The HTTP is running normally.
			Warning	Monitoring is suspended on a server.
			Error	The HTTP has an error.
			Dummy Failure	Dummy Failure is enabled.















No.	Icon	Status	Description	
		Unknown	No information is acquired.	
(56)	IMAP4 monitor resource ²		Normal	The IMAP4 is running normally.
			Warning	Monitoring is suspended on a server.
			Error	The IMAP4 has an error.
			Dummy Failure	Dummy Failure is enabled.
			Unknown	No information is acquired.
(57)	ODBC monitor resource ²		Normal	The ODBC is running normally.
			Warning	Monitoring is suspended on a server.
			Error	The ODBC has an error.
			Dummy Failure	Dummy Failure is enabled.
			Unknown	No information is acquired.
(58)	Oracle monitor resource ²		Normal	The Oracle monitor resource is running normally.
			Warning	Monitoring is suspended on a server.
			Error	The Oracle monitor resource has an error.
			Dummy Failure	Dummy Failure is enabled.
			Unknown	No information is acquired.
(59)	OracleAS monitor resource ²		Normal	The OracleAS monitor resource is running normally.
			Warning	Monitoring is suspended on a server.
			Error	The OracleAS monitor resource has an error.
			Dummy Failure	Dummy Failure is enabled.
			Unknown	No information is acquired.

No.	Icon	Status	Description	
(60)	OfficeScan CL monitor resource ²		Normal	OfficeScan client is running normally.
			Warning	Monitoring is suspended on some server.
			Error	OfficeScan client has an error.
			Dummy Failure	Dummy Failure is enabled.
			Unknown	No information is acquired.
(61)	OfficeScan SV monitor resource ²		Normal	OfficeScan server is running normally.
			Warning	Monitoring is suspended on some server.
			Error	OfficeScan server has an error.
			Dummy Failure	Dummy Failure is enabled.
			Unknown	No information is acquired.
(62)	POP3 monitor resource ²		Normal	The POP3 monitor resource is running normally.
			Warning	Monitoring is suspended on a server.
			Error	The POP3 monitor resource has an error.
			Dummy Failure	Dummy Failure is enabled.
			Unknown	No information is acquired.
(63)	PostgreSQL monitor resource ²		Normal	The PostgreSQL is running normally.
			Warning	Monitoring is suspended on a server.
			Error	The PostgreSQL has an error.
			Dummy Failure	Dummy Failure is enabled.
			Unknown	No information is acquired.

No.	Icon	Status	Description	
(64)	SMTP monitor resource ²		Normal	The SMTP monitor is running smoothly.
			Warning	Monitoring is suspended on a server.
			Error	The SMTP resource has an error.
			Dummy Failure	Dummy Failure is enabled.
			Unknown	No information is acquired.
(65)	SQL Server monitor resource ²		Normal	The SQL Server is running normally.
			Warning	Monitoring is suspended on a server.
			Error	The SQL Server has an error.
			Dummy Failure	Dummy Failure is enabled.
			Unknown	No information is acquired.
(66)	Tuxedo monitor resource ²		Normal	The Tuxedo is running normally.
			Warning	Monitoring is suspended on a server.
			Error	The Tuxedo has an error.
			Dummy Failure	Dummy Failure is enabled.
			Unknown	No information is acquired.
(67)	Websphere monitor resource ²		Normal	The WebSphere is running normally.
			Warning	Monitoring is suspended on a server.
			Error	The WebSphere has an error.
			Dummy Failure	Dummy Failure is enabled.
			Unknown	No information is acquired.

No.	Icon	Status	Description	
(68)	WebLogic monitor resource ²		Normal	The WebLogic is running normally.
			Warning	Monitoring is suspended on a server.
			Error	The WebLogic has an error.
			Dummy Failure	Dummy Failure is enabled.
			Unknown	No information is acquired.
(69)	WebOTX monitor resource ²		Normal	The WebOTX is running normally.
			Warning	Monitoring is suspended on a server.
			Error	The WebOTX has an error.
			Dummy Failure	Dummy Failure is enabled.
			Unknown	No information is acquired.
(70)	JVM monitor resource ²		Normal	JavaVM is running normally.
			Warning	Monitoring is suspended on a server.
			Error	The load on the JavaVM exceeds the configured value.
			Dummy Failure	Dummy Failure is enabled.
			Unknown	No information is acquired.
(71)	System monitor resource ²		Normal	System Resource Agent is running normally.
			Warning	Monitoring is suspended on a server.
			Error	System Resource Agent has an error.
			Dummy Failure	Dummy Failure is enabled.
			Unknown	No information is acquired.

No.	Icon	Status	Description	
(72)	Process name monitor resource ²		Normal	The specified process is running normally.
			Warning	Monitoring is suspended on a server.
			Error	The specified process is suspended.
			Dummy Failure	Dummy Failure is enabled.
			Unknown	No information is acquired.
(73)	Dynamic DNS monitor resource ²		Normal	The dynamic DNS monitor resource is running normally.
			Warning	Monitoring is suspended on a server.
			Error	The dynamic DNS monitor resource has an error.
			Unknown	No information is acquired.
(74)	User space monitor resource ²		Normal	The user space is running normally.
			Warning	One or more servers have an error, or monitoring is suspended on a server.
			Error	The user space is not running normally on all servers.
			Unknown	No information is acquired.
(75)	AWS elastic ip monitor resource		Normal	The AWS elastic ip monitor resource is running normally.
			Warning	Acquiring the AWS CLI command response failed on a server, or monitoring is suspended on a server.
			Error	The AWS elastic ip monitor resource has an error.
			Dummy Failure	Dummy Failure is enabled.
			Unknown	No information is acquired.
(76)	AWS virtual ip monitor resource		Normal	The AWS virtual ip monitor resource is running normally.
			Warning	Acquiring the AWS CLI command response failed on a server, or monitoring is suspended on a server.
			Error	The AWS virtual ip monitor resource has an error.
			Dummy Failure	Dummy Failure is enabled.
			Unknown	No information is acquired.
(77)	AWS AZ monitor resource		Normal	The AWS AZ monitor resource is running normally.

No.	Icon	Status	Description	
		Warning	Acquiring the AWS CLI command response failed on a server, or monitoring is suspended on a server.	
		Error	The AWS AZ monitor resource has an error.	
		Dummy Failure	Dummy Failure is enabled.	
		Unknown	No information is acquired.	
(78)	Azure probe port monitor resource		Normal	The Azure probe port monitor resource is running normally.
		Warning	Probe port wait timeout occurred in the Azure probe port monitor resource to be monitored on a server, or monitoring is suspended on a server.	
		Error	The Azure probe port monitor resource has an error.	
		Dummy Failure	Dummy Failure is enabled.	
		Unknown	No information is acquired.	
(79)	Azure load balance monitor resource		Normal	The Azure load balance monitor resource is running normally.
		Warning	Monitoring for the Azure load balance monitor resource is suspended on a server.	
		Error	The Azure load balance monitor resource has an error.	
		Dummy Failure	Dummy Failure is enabled.	
		Unknown	No information is acquired.	

Operations from the WebManager

You can operate a cluster by right-clicking (1) a cluster, (3) an individual server, (10) an individual group, or (24) a VM resource and choosing an operation.

Objects of the cluster

When you right-click the **cluster** object, the following shortcut menu is displayed.

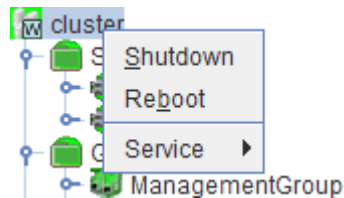

◆ Shut down

Shuts down all running servers. When you select **Shutdown**, the following dialog box is displayed for confirmation.

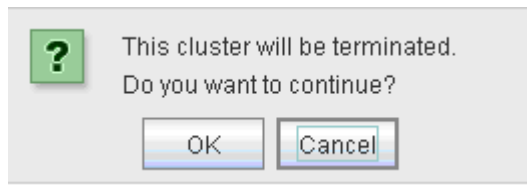

The server that cannot communicate with the server (all LAN heartbeat resources are stopped) connected to the WebManager does not shut down.

◆ Reboot

Reboots all running servers. When you select **Reboot**, the following dialog box is displayed for confirmation.

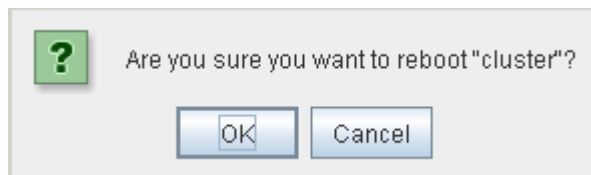

◆ Service

If you select **Service**, **Suspend Cluster**, **Resume Cluster**, **Start Cluster**, **Stop Cluster** and **Restart Manager** are displayed on the shortcut menu.

Server object

When you right-click the **servers** object, the following shortcut menu is displayed.

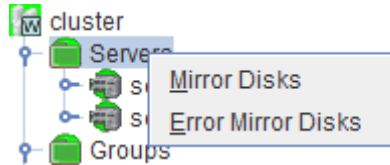

◆ Mirror Disk List

If you select this operation, the following dialog box of the mirror disk list is displayed, and the list of all mirror disk resources and hybrid disk resources is displayed.

Mirror Disk Name	Synchronization Mode	Difference Copy	server1	server2
md1	Synchronous	Possible	Abnormal	Abnormal

Update Details Close

• **Detail** (Starts **Mirror Disk Helper**)

Starts the **Mirror Disk Helper** dialog box for the selected mirror disk resource/hybrid disk resource.

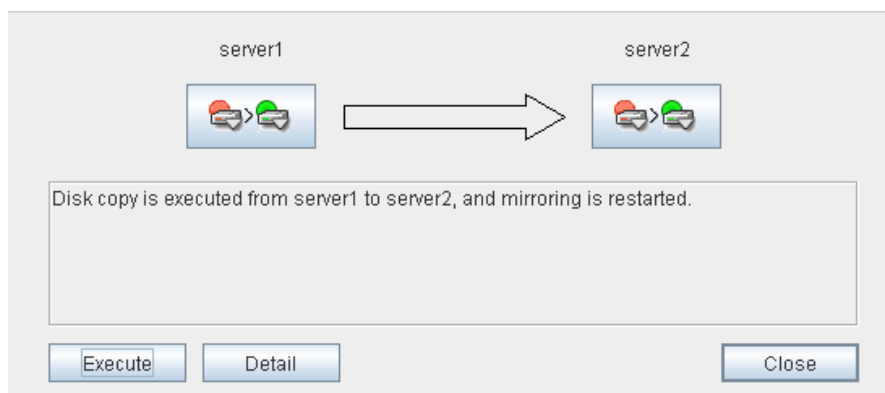

For information on using the Mirror Disk Helper, see “Mirror disk helper” on page 83.

◆ Error Mirror Disk List

Lists mirror disk resources and hybrid disk resources with an error in the dialog box.

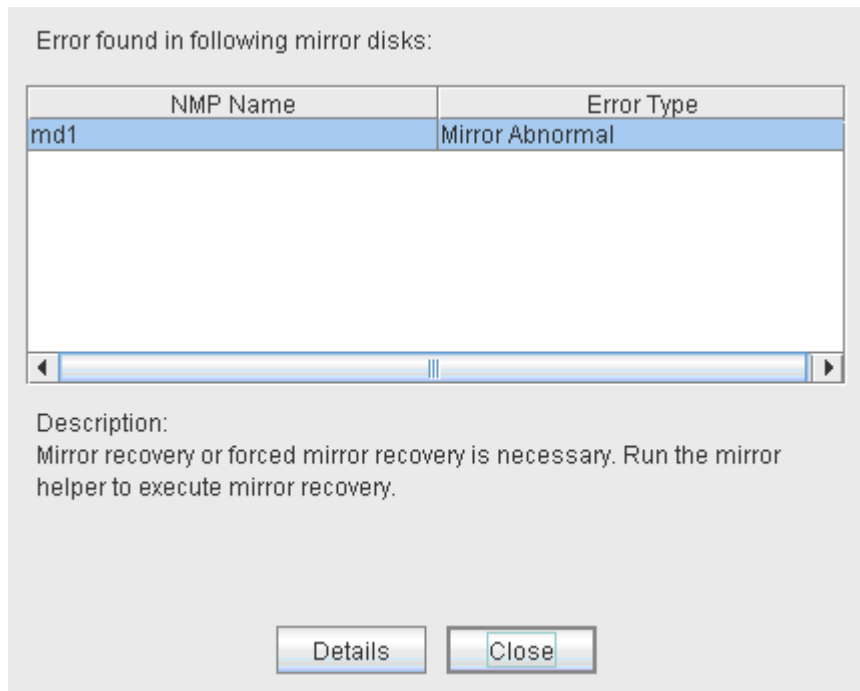

If there is a mirror disk with an error listed below in the cluster, the above dialog box will be displayed automatically.

The description provides what you should do for the error.

Error type	Description
Mirror Error	Mirror recovery or forced mirror recovery is necessary. Run the Mirror Helper and perform mirror recovery. If a communication status error occurs during mirror disk connect, check the communication status.
Mirror Error (Single Server Run)	Only one server is running, and the latest data of a mirror disk is not completed. To continue the operation, run the Mirror Helper and execute mirror recovery. Be careful since the server that is currently running will be the latest data when the mirror recovery is executed.

When you select **Details**, the Mirror Disk Helper is activated.

Individual server objects

When you right-click an individual server object, the following shortcut menu is displayed.

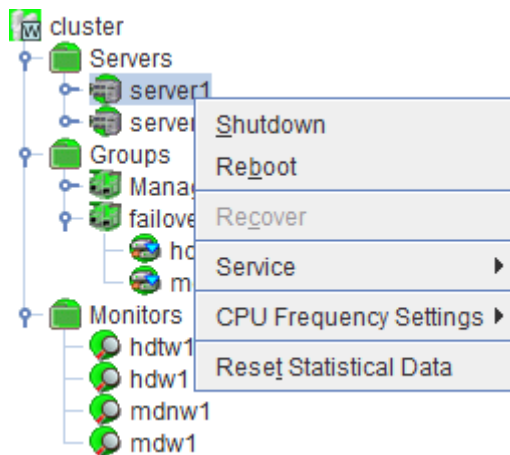

◆ Shut down

Shuts down the selected server. When you select this operation, the following dialog box is displayed for confirmation.

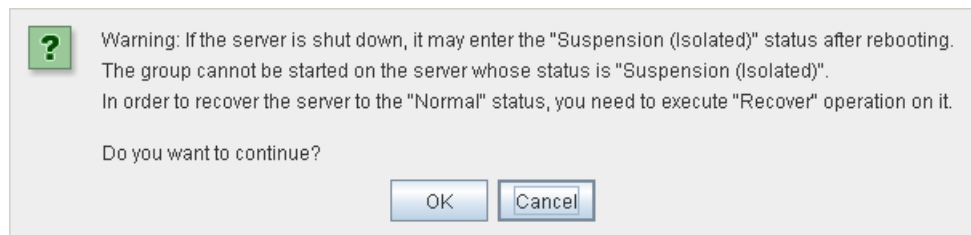

◆ Reboot

Reboots the selected server. When you select this operation, the following dialog box is displayed for confirmation.

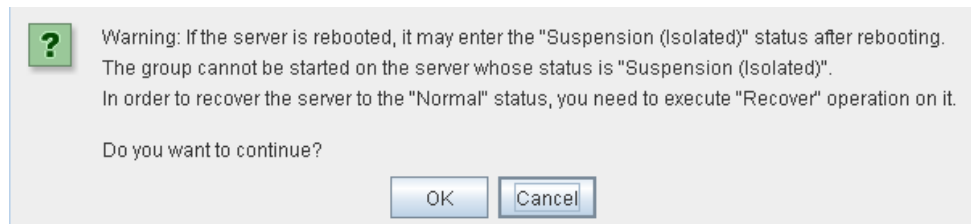

◆ Recover

Recovers the selected server. When you select this operation, the following dialog box is displayed for confirmation.

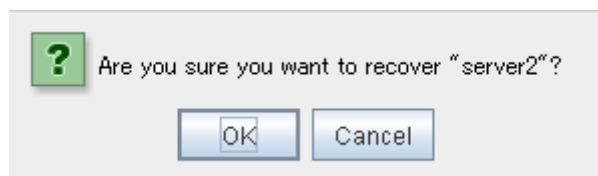

◆ Service

Starts and stop the selected service. If you select this operation, the following dialog box is displayed for confirmation.

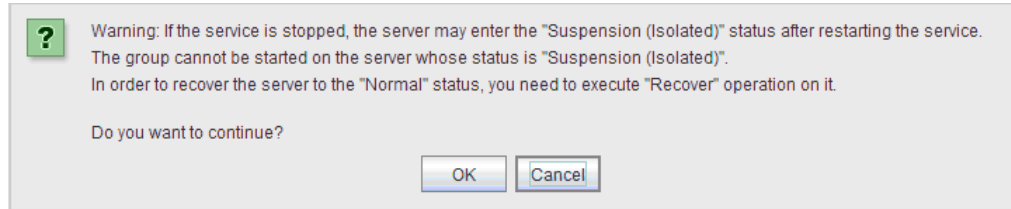

◆ CPU Frequency Settings

Configures the CPU frequency control function of the selected server.

- Highest Frequency
Sets the CPU frequency to the highest.

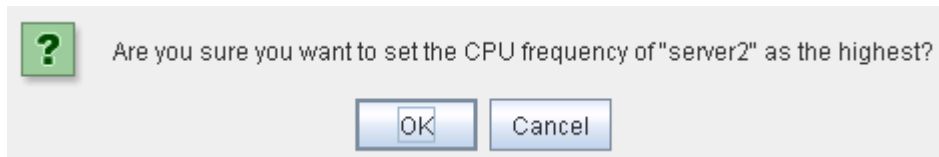

- Lowest Frequency
Lowers the frequency to turn it to power-saving mode.

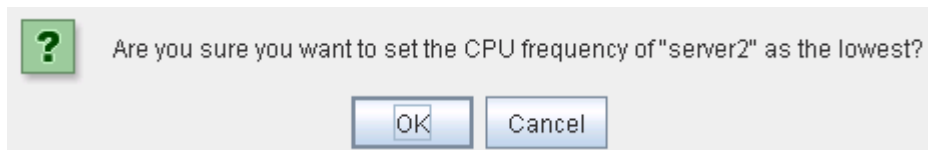

- Auto
Restores the CPU frequency control to the control by EXPRESSCLUSTER.

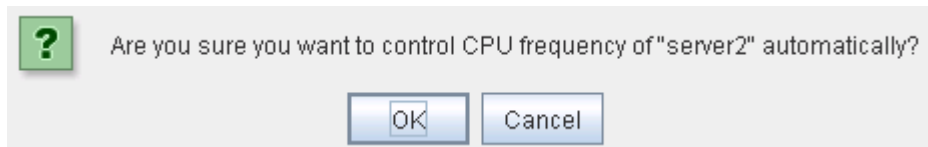

This function cannot be used when **Use CPU Frequency Control** is not checked on the **Power Saving** tab of **Cluster Properties**.

◆ **Reset Statistical Data**

Resets the statistical data for the selected server. If you select this operation, the following dialog box is displayed for confirmation.

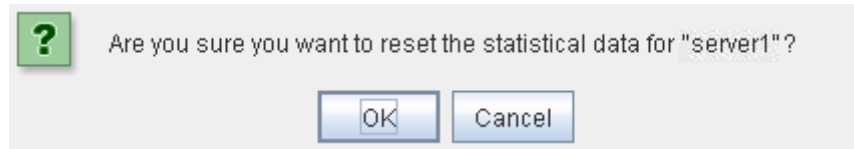

Individual group objects

When you right-click an individual group object, the following shortcut menu is displayed.

When group type is failover.

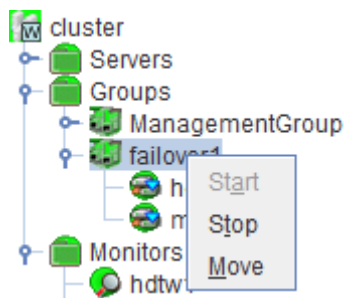

When group type is virtualmachine.

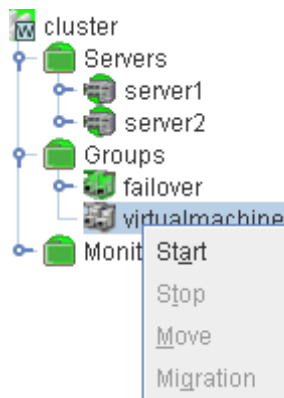

◆ **Start (enabled only when the group is stopped)**

Starts up the selected group. The dialog box for choosing a server that starts up the selected group is displayed.



- ◆ Stop (enabled only when the group has been started up or when it has an error)
Stops the selected group. When you select this operation, the following dialog box is displayed for confirmation.

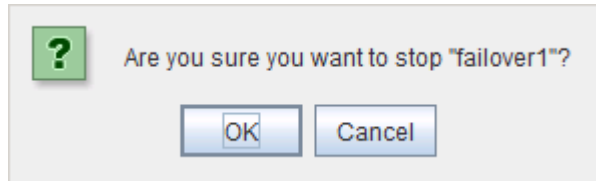

- ◆ Move (enabled only when the group has been started up)
Moves the selected group. The dialog box for choosing a server to which you want to move the selected group is displayed.

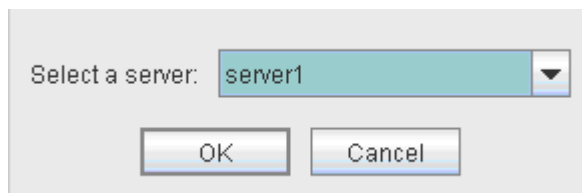

- ◆ Migration (Only selectable when group type is virtualmachine and it is running.)
Stop the virtual machine temporarily which is managed by the virtual machine resource of the selected group, and move the group to another server. The dialog is displayed to select the server to which the selected group is moved.



The temporarily stopped virtual machine is resumed on the destination server.

Individual group resource objects (except mirror disk resources and hybrid disk resources)

When you right-click an individual group resource object, the following shortcut menu is displayed.

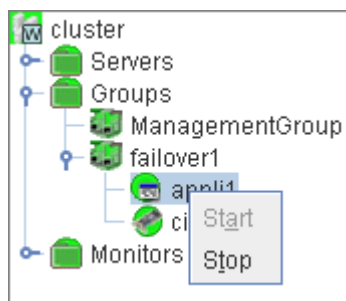

- ◆ Start (enabled only when the group is stopped)

Starts up the selected group resource.

The dialog box for selecting the server that starts up the selected group is displayed.

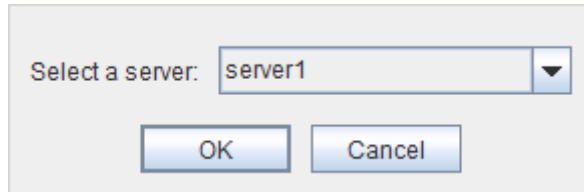

- ◆ Stop (enabled only when the group has been started up or when it has an error)

Stops the selected group resource. When you selected this operation, the following dialog box is displayed for confirmation.

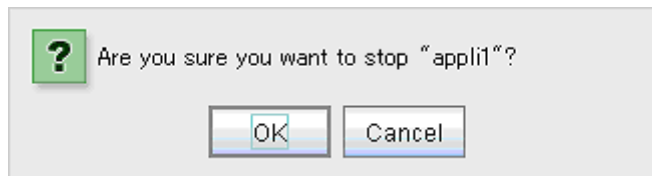

Objects of mirror disk resource and hybrid disk resource

When you right-click a mirror disk resource object, the following shortcut menu is displayed.

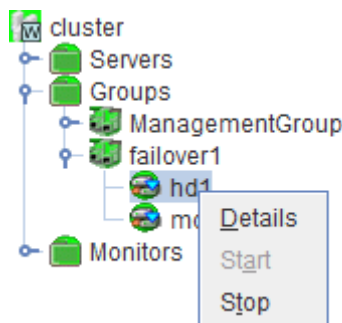

◆ Details

Starts up the Mirror Disk Helper for the selected mirror disk resource/hybrid disk resource, and the following dialog box for the Mirror Disk Helper is displayed.

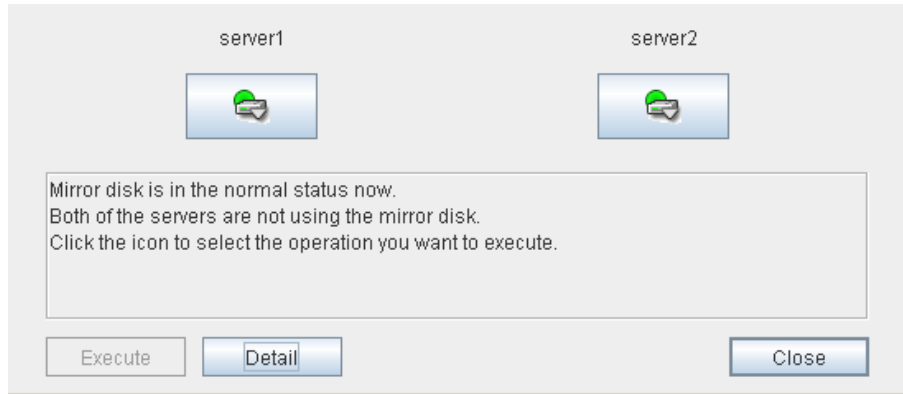

For information on using the Mirror Disk Helper, see “Mirror disk helper” on page 83.

Monitor resource objects

When you right-click a monitor resource object, the following shortcut menu is displayed.

When operation mode is selected

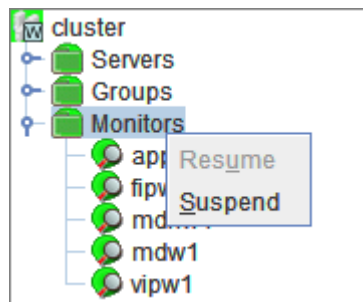

When verification mode is selected

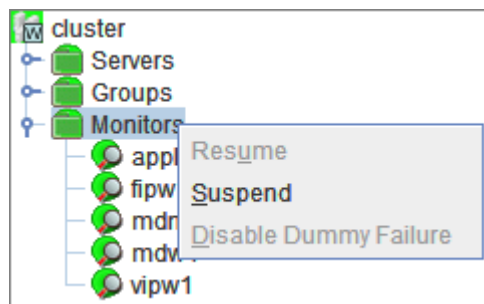

- ◆ Resume (enabled when the resources are stopped temporarily)

Resumes all the currently configured monitor resources. This operation is not performed for those monitor resources for which the suspending/resuming of monitoring is not possible. A dialog box for selecting the server on which the monitor resources will be resumed is displayed.

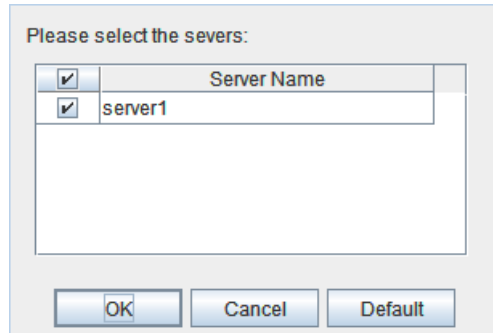

- ◆ Suspend (enabled when the resources are monitoring)

Suspends all the currently configured monitor resources. This operation is not performed for those monitor resources for which the suspending/resuming of monitoring is not possible. A dialog box for selecting the server on which the monitor resources will be stopped temporarily is displayed.

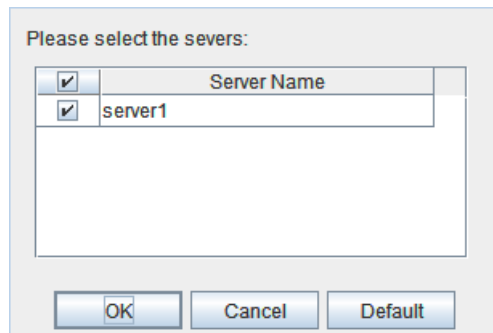

Note: When an attempt is made to enable dummy failure, and if one or more servers cannot be connected, an error is displayed. Dummy failure cannot be enabled on a server that cannot be connected.

- ◆ Stop Dummy Failure (enabled only when dummy failure is started)

Stops the dummy failure that has been set for all monitor resources. The following dialog box for selecting the server on which dummy failure in the monitor resources is to be stopped is displayed.

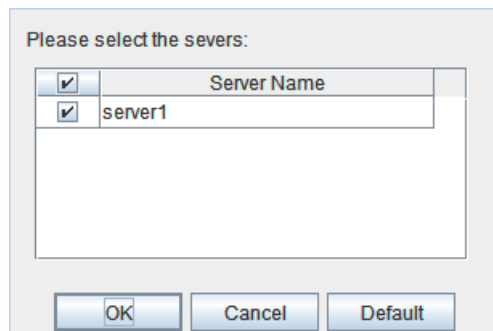

Individual monitor resource objects

When you right-click an individual monitor resource object, the following shortcut menu is displayed.

When operation mode is selected

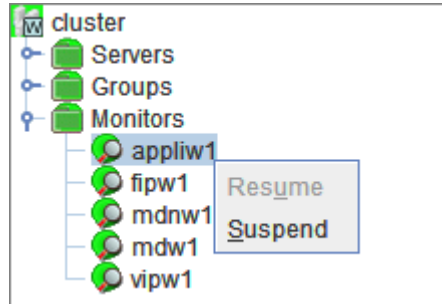

When verification mode is selected

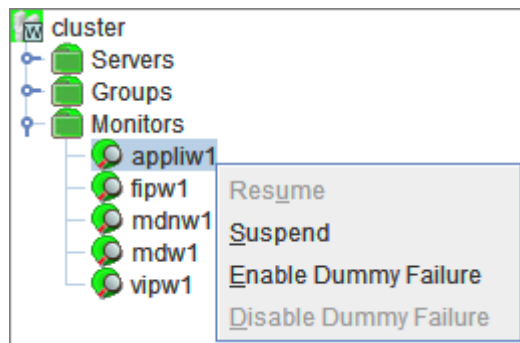

- ◆ Resume (enabled when the resource is stopped temporarily)

Resumes a selected monitor resource. The dialog box for choosing the server on which the selected monitor resource is resumed.

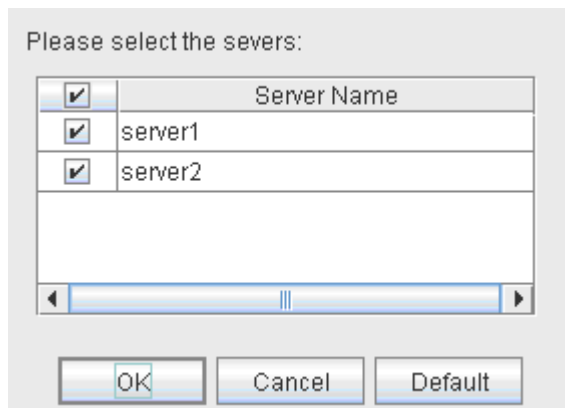

- ◆ Suspend (enabled when the resource is monitoring)

Resumes the selected monitor resource. The dialog box for choosing the server on which the selected monitor resource is stopped temporarily.

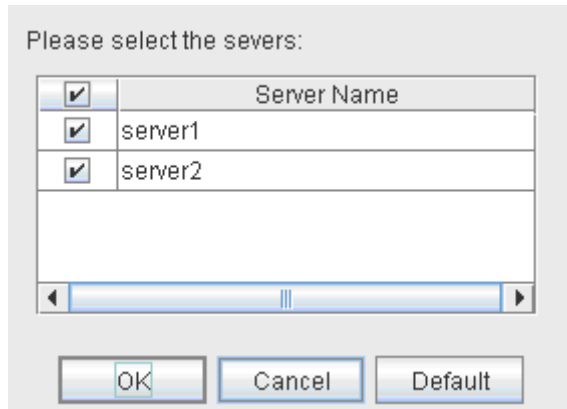

- ◆ Start Dummy Failure (enabled when verification mode is not executed)

Generates a simulated fault in a selected monitor resource. A simulated fault can be generated only on a server on which **Resource Status on Each Server** of the relevant monitor resource is other than **Error** or **Dummy Failure**.

Note, however, that the following monitor resources cannot be selected:

- Mirror connect monitor resource
- Mirror disk monitor resource
- Hybrid disk monitor resource
- Message receive monitor resource
- VM monitor resource

The following dialog box for selecting the server on which A dummy failure is generated. for a selected monitor resource is displayed.

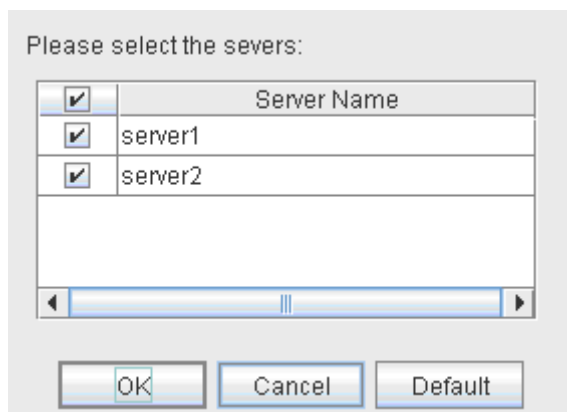

- ◆ Stop Dummy Failure (enabled when verification mode is executed)

Stops the dummy failure generated in a selected monitor resource. The following dialog box for selecting the server on which the dummy failure is to be stopped for a selected monitor resource is displayed.

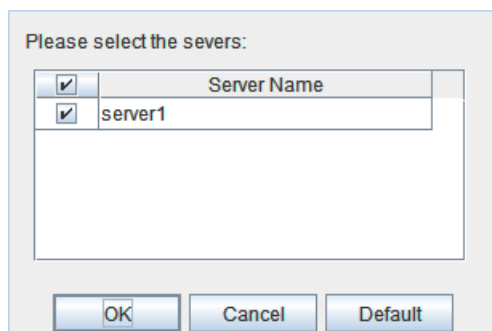

Checking the cluster status by the WebManager list view

The detailed information on the selected object in the tree view of the WebManager can be displayed in the list view.

To display information on the whole cluster

1. Start the WebManager. (http://Management IP address or cluster server IP address:port_number (default value is 29003))
2. In this tree view, click the object icon  for the cluster. In the list view in the right pane of the window, the group status and monitor resource status of each server are displayed.

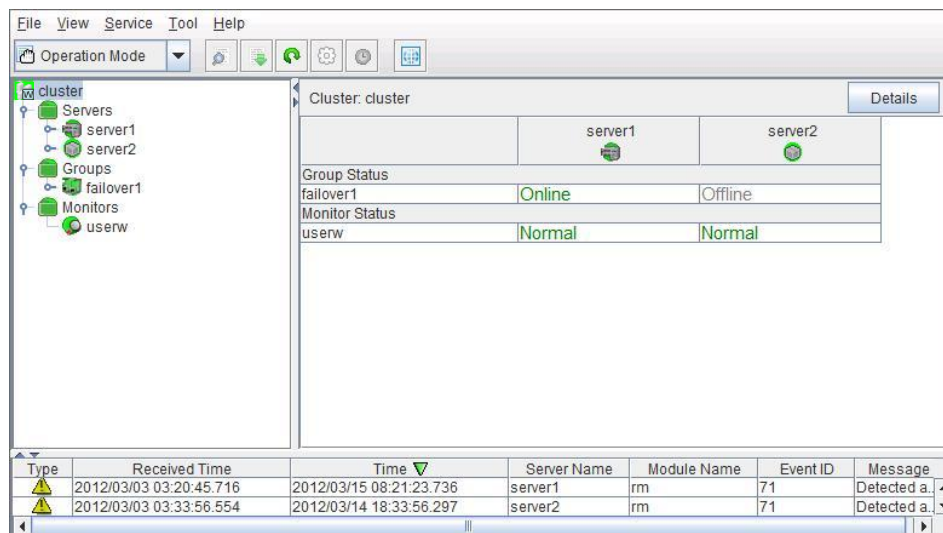

3. Click Details to display the following in the dialog box.

Info

Properties		Value	
Name	cluster		
Comment			
Status	Normal		

Name: Cluster name
 Comment: Comment for the cluster
 Status: Status of the cluster

Heartbeat I/F

Alert Service	Delay Warning	Disk	Mirror Disk	Auto Recovery	Power Saving	JVM monitor
Info	Heartbeat I/F	NP Resolution	Timeout	Port Number	Monitor	Recovery
Properties			Value			
Server Down Notification			On			
Cast Method			Unicast			

Server Down Notification: When you set this to On, one server is allowed to tell the other servers that it is being shut down by the commands from WebManager or command line, so that a failover occurs independently of the heartbeat timeout settings.

Note: Even if **Server Down Notification** is set to **On**, failover is performed after a heartbeat timeout when shutdown is performed with a method other than the WebManager or a command.

Cast Method: Configures the Heartbeat Cast Method (Unicast / Broadcast); Broadcast is unavailable when the IP address of the Heartbeat I/F is configured with IPv6.

NP Resolution

Alert Service	Delay Warning	Disk	Mirror Disk	Auto Recovery	Power Saving	JVM monitor
Info	Heartbeat I/F	NP Resolution	Timeout	Port Number	Monitor	Recovery
Properties			Value			
Action at NP Occurrence			Emergency shutdown			

Action at NP Occurrence: Action to be taken when a network partition occurs

Timeout

Alert Service	Delay Warning	Disk	Mirror Disk	Auto Recovery	Power Saving	JVM monitor
Info	Heartbeat I/F	NP Resolution	Timeout	Port Number	Monitor	Recovery
Properties			Value			
Server Sync Wait Time			300			
Heartbeat Timeout			30000			
Heartbeat Interval			3000			
Server Internal Timeout			180			
Timeout Ratio			1			

Server Sync Wait Time: Time to wait for the other servers to start up (in seconds)
 Heartbeat Timeout: Heartbeat timeout (in milliseconds)
 Heartbeat Interval: The interval for sending heartbeats (milliseconds)
 Server Internal Timeout: Internal communication timeout (in seconds)
 Timeout Ratio: Current timeout ratio

Port Number

Alert Service	Delay Warning	Disk	Mirror Disk	Auto Recovery	Power Saving	JVM monitor
Info	Heartbeat I/F	NP Resolution	Timeout	Port Number	Monitor	Recovery
Properties			Value			
Server Internal Port Number			29001			
Data Transfer Port Number			29002			
Kernel Mode Heartbeat Port Number			29106			
Client Service Port Number			29007			
WebManager HTTP Port Number			29003			
Alert Sync Port Number			29003			
Disk Agent Port Number			29004			
Mirror Driver Port Number			29005			

Server Internal Port Number: Port number for internal communication
 Data Transfer Port Number: Port number for data transfer
 Kernel Mode Heartbeat Port Number: Port number for kernel-mode heartbeat
 Client Service Port Number: Port number for client service
 WebManager HTTP Port Number: Port number for WebManager
 Alert Sync Port Number: Port number for alert synchronization
 Disk Agent Port Number: Port number for disk agent

Mirror Driver Port Number: Port number for mirror driver (Only when Replicator/Replicator DR is used)

Monitor

Alert Service	Delay Warning	Disk	Mirror Disk	Auto Recovery	Power Saving	JVM monitor
Info	Heartbeat I/F	NP Resolution	Timeout	Port Number	Monitor	Recovery
Properties				Value		
Collect System Resource Information				Off		

Collect System Resource Information: Whether or not to collect System Resource Information

Recovery

Alert Service	Delay Warning	Disk	Mirror Disk	Auto Recovery	Power Saving	JVM monitor
Info	Heartbeat I/F	NP Resolution	Timeout	Port Number	Monitor	Recovery
Properties				Value		
Max Reboot Count				0		
Max Reboot Count Reset Time				0		
Use Forced Stop				Off		
Forced Stop Action				BMC Power Off		
Forced Stop Timeout (sec)				3		
Execute Script for Forced Stop				Off		
Action When the Cluster Service Process Is Failure				Shut down the OS		
Recovery Action for HA Agents:Max Restart Count				3		
Recovery Action for HA Agents:Recovery Action over Ma...				No operation		
Disable Recovery Action Caused by Monitor Resource ...				Off		
Action at Group Resource Activation or Deactivation Stall				Emergency shutdown		
Restrain the shutdown action if only one server is alive ...				Off		
Restrain the shutdown action if only one server is alive ...				Off		
Restrain the shutdown action if only one server is alive ...				Off		

Max Reboot Count: Maximum reboots count
 Max Reboot Count Reset Time: Time to reset maximum reboot count (in seconds)
 Use Forced Stop: Whether or not to perform the forced stop function
 Forced Stop Action: Action of forced stop function
 Forced Stop Timeout: Wait time until activation of failover group starts after forced stop has been performed (in seconds)
 Execute Script for Forced Stop Whether to execute a script for forced stop

Action When the Cluster Service Process Is Failure: Action to be taken when a cluster service process fails

Recovery Action for HA Agents:Max Restart Count: Maximum count to restart an HA process if the process fails

Recovery Action for HA Agents:Recovery Action over Max Restart Count: Action to be taken when the HA process fails and the process cannot be restarted even after retrying restart of the process for the maximum number of retries

Disable Recovery Action Caused by Monitor Resource Failure: Whether or not to disable the recovery action when the monitor resource fails

Action at Group Resource Activation or Deactivation Stall: Action to be taken when group resource activation/deactivation is stalled

Restrain the shutdown action if only one server is alive (when active group resource abnormality detected):

Whether to disable shutdown at activation failure in the case of the last one server

Restrain the shutdown action if only one server is alive (when deactive group resource abnormality detected):

Whether to disable shutdown at deactivation failure in the case of the last one server

Restrain the shutdown action if only one server is alive (when monitoring resource abnormality detected):

Whether to disable shutdown at monitoring failure in the case of the last one server

Alert Service

Alert Service	Delay Warning	Disk	Mirror Disk	Auto Recovery	Power Saving	JVM monitor
Info	Heartbeat I/F	NP Resolution	Timeout	Port Number	Monitor	Recovery
Properties			Value			
E-mail Address						
Use Network Warning Light			Off			
Use Chassis Identify			Off			
Enable Alert Setting			Off			

E-mail Address: Destination mail address
 Use Network Warning Light: Whether or not to use a network warning light
 Use Chassis Identify: Whether or not to use chassis ID lamp association
 Enable Alert Setting: Whether or not to enable setting

Delay Warning

Alert Service	Delay Warning	Disk	Mirror Disk	Auto Recovery	Power Saving	JVM monitor
Info	Heartbeat I/F	NP Resolution	Timeout	Port Number	Monitor	Recovery
Properties			Value			
Heartbeat Delay Warning			80			
Monitor Delay Warning			80			
COM Delay Warning			80			

Heartbeat Delay Warning: Heartbeat delay warning (%)
 Monitor Delay Warning: Monitor delay warning (%)
 COM Delay Warning: COM communication delay warning (%)

Disk

Alert Service	Delay Warning	Disk	Mirror Disk	Auto Recovery	Power Saving	JVM monitor
Info	Heartbeat I/F	NP Resolution	Timeout	Port Number	Monitor	Recovery
Properties			Value			
Shared Disk Disconnection Retry Threshold			10			
Shared Disk Disconnection Timeout			1800			
Shared Disk Disconnection Retry Interval			3			
Shared Disk Disconnection Final Action			Disconnect forcefully			

Shared Disk Disconnection Retry Threshold: Shared disk disconnection retry threshold
 Shared Disk Disconnection Timeout: Shared disk disconnection timeout (in seconds)
 Shared Disk Disconnection Retry Interval: Shared disk disconnection retry interval (in seconds)
 Shared Disk Disconnection Final Action: Shared disk disconnection final action

Mirror disk (Only when Replicator/Replicator DR is used)

Alert Service	Delay Warning	Disk	Mirror Disk	Auto Recovery	Power Saving	JVM monitor
Info	Heartbeat I/F	NP Resolution	Timeout	Port Number	Monitor	Recovery
Properties			Value			
Auto First Mirror Construction			On			
Auto Mirror Recovery			On			
Collect Mirror Statistics			On			
Mirror Disk Disconnection Retry Threshold			10			
Mirror Disk Disconnection Timeout			1800			
Mirror Disk Disconnection Retry Interval			3			
Mirror Disk Disconnection Final Action			Disconnect forcefully			

Auto First Mirror Construction: Whether or not to perform auto mirror initial construction.
 Auto Mirror Recovery: Whether or not to perform auto mirror recovery.
 Collect Mirror Statistics: Whether or not to perform mirror statistics collection
 Mirror Disk Disconnection Retry Threshold: Mirror disk disconnection retry threshold
 Mirror Disk Disconnection Timeout: Mirror disk disconnection timeout (in seconds)

Mirror Disk Disconnection Retry Interval: Mirror disk disconnection retry interval (in seconds)
 Mirror Disk Disconnection Final Action: The final action at mirror disk disconnection

Auto Recovery

Alert Service	Delay Warning	Disk	Mirror Disk	Auto Recovery	Power Saving	JVM monitor
Info	Heartbeat I/F	NP Resolution	Timeout	Port Number	Monitor	Recovery
Properties				Value		
Auto Recovery				On		

Auto Recovery: The setting whether server recovery is automatically performed after cluster server is rebooted from "Suspension (Isolated)."

Power Saving

Alert Service	Delay Warning	Disk	Mirror Disk	Auto Recovery	Power Saving	JVM monitor
Info	Heartbeat I/F	NP Resolution	Timeout	Port Number	Monitor	Recovery
Properties				Value		
Use CPU Frequency Control				Off		

Use CPU Frequency Control: Whether or not to use CPU frequency control

JVM monitor

Alert Service	Delay Warning	Disk	Mirror Disk	Auto Recovery	Power Saving	JVM monitor
Info	Heartbeat I/F	NP Resolution	Timeout	Port Number	Monitor	Recovery
Properties				Value		
Java Install Path						
Maximum Java Heap Size (MB)				7		
Load Balancer Connection Setting				Off		
Log Level				INFO		
Generation Count for Stored Log Files				10		
Log Rotation Type				File Size		
Log File Maximum Size (KB)				3072		
Time of First Log Rotation				00:00		
Log Rotation Interval (Hours)				24		
Resource Measurement: Retry Count				10		
Resource Measurement: Threshold for Abnormal Jud...				5		
Resource Measurement: Default Interval				60		
Resource Measurement: Interval for Full GC				120		
WebLogic Monitoring: Retry Count				3		
WebLogic Monitoring: Threshold for Abnormal Judgm...				5		
WebLogic Monitoring: Request Count Measurement I...				60		
WebLogic Monitoring: Interval for Average measurem...				300		
Management Port				25500		
Connection Retry Count				3		
Time until Reconnect				60		
Management Port for Load Balancer Linkage				25550		
Health Check Linkage Function				Off		
Directory containing HTML files						
HTML File Name						
HTML Renamed File Name						
Retry count for renaming				3		
Wait time for retry				3		
Management IP Address						
Connection Port				443		

Java Installation Path: Java installation path
 Maximum Java Heap Size (MB): Maximum Java heap size (MB)
 Load Balancer Connection Setting: Load balancer linkage settings
 Log Level: Log level
 Generation Count for Stored Log files: Number of generations of log files to be stored
 Log Rotation Type: Log rotation type
 Log File Maximum Size (KB): Maximum log file size (KB)
 Time of First Log Rotation: Time of the first log rotation
 Log Rotation Interval (Hours): Log rotation interval (hours)
 Resource Measurement: Retry Count: Resource measurement: Measurement retry count

Resource Measurement: Threshold for Abnormal Judgment:	Resource Measurement: Threshold for Abnormal Judgment:
Resource Measurement: Default Interval:	Resource measurement: Interval for memory and thread measurement (sec)
Resource Measurement: Interval for Full GC:	Resource measurement: Interval for Full GC measurement (sec)
WebLogic Monitoring: Retry Count:	WebLogic monitoring: Measurement retry count
WebLogic Monitoring: Threshold for Abnormal Judgment:	WebLogic Monitoring: Threshold for Abnormal Judgment:
WebLogic Monitoring: Request Count Measurement Interval:	WebLogic monitoring: Interval for measuring the number of requests (sec)
WebLogic Monitoring: Interval for Average measurement:	WebLogic monitoring: Interval for measuring the average (sec)
Management Port:	Management port number
Connection Retry Count:	Connection retry count
Time until Reconnect:	Time to wait for reconnection (sec)
Management Port for Load Balancer Linkage:	Management port number for load balancer linkage
Health Check Linkage Function:	Whether or not to use the health check linkage function
Directory containing HTML files:	HTML storage directory
HTML File Name:	HTML file name
HTML Renamed File Name:	Renamed HTML file name
Retry Count for renaming:	Retry count if renaming fails
Wait time for retry:	Time to wait for a renaming retry (sec)
Management IP Address:	BIG-IP LTM management IP address
Connection Port:	Communication port number for BIG-IP LTM

Checking the whole status of the server in the WebManager list view

1. Start the WebManager.
2. In the tree view, select the object icon for the entire server . In the upper part of the list view in the right pane, the heartbeat status and network partition resolution status list of each server are displayed.

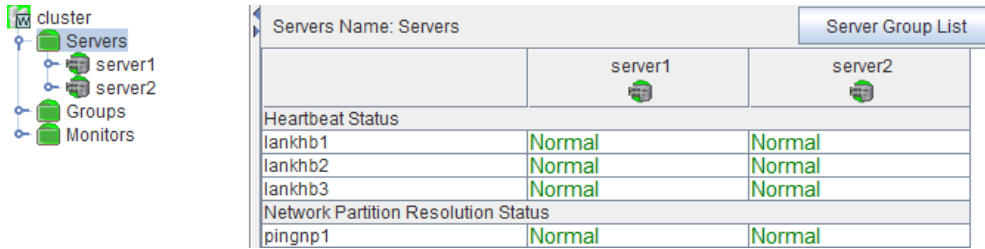

Servers Name: Servers			Server Group List
	server1	server2	
Heartbeat Status			
lankhb1	Normal	Normal	
lankhb2	Normal	Normal	
lankhb3	Normal	Normal	
Network Partition Resolution Status			
pingnp1	Normal	Normal	

Additionally, click **Server Group List** to display the information of the server group on the pop up dialog.

ServerGroup Name	Server Name
svg1	server1
svg2	server2

Checking the status of individual server in the WebManager list view

1. Start the WebManager.
2. If the object  of a server is selected in the tree view, **Comment**, **Version**, **Product**, **Internal Version**, **Install Path** and **Status** of the server are displayed.

Server Name: server1		Details
Properties	Value	
Comment		
Virtual Infrastructure		
Product	EXPRESSCLUSTER X 3.2 for Windows	
Internal Version	11.21	
Install Path	C:\Program Files\EXPRESSCLUSTER	
Status	Online	
Heartbeat Status		
lankhb1	Normal	
lankhb2	Normal	
Network Partition Resolution Status		

Comment:	Comment for the server
Virtual Infrastructure	Virtual infrastructure name
Product	Name of the product
Internal Version:	Internal version
Install Path:	Install path of EXPRESSCLUSTER
Status:	Status of the server

3. Click **Details** to display the following in the dialog box.

Properties	Value
Name	server1
Mirror Disk Connect IP Address mdc[1]	192.168.0.1
Network Warning Light IP Address(Type)	
BMC IP Address	
CPU Frequency Status	-
No shutdown when double activation detected	Off

Name:	Server name
Mirror Disk Connect IP Address mdc[1] ³ :	IP address of mirror disk connection
Network Warning Light IP Address(Type):	IP address of network warning light
BMC IP address:	BMC IP address
CPU Frequency Status:	Current setting status of CPU frequency control
No shutdown when double activation detected:	Whether to disable shutdown when activation of both disks is detected

Checking the status of the whole monitor in the WebManager list view

1. Start the WebManager.
2. In the tree view, select the object icon for the entire monitor . In the list view, Monitor Name and a list of server statuses are displayed.

³ The I/F number of the mirror disk connection is entered to the number in the parentheses.
Section I Detailed functions of EXPRESSCLUSTER

Checking alerts using the WebManager

You can view alerts in the bottom part of the WebManager.

Each field of the alert view is configured as follows.



	Received Time	Time	Server Name	Module Name	Event ID	Message
🔊	2005/09/14 11:11:08.123	2005/09/14 11:11:06.367	server1	rm	26	Status of mdw1 changed normally.
🔊	2005/09/14 11:11:03.197	2005/09/14 11:11:02.962	server1	rm	26	Status of mdw1 changed normally.
🔊	2005/09/14 11:11:04.327	2005/09/14 11:11:01.857	server1	rm	26	Status of mdw2 changed normally.
🔊	2005/09/14 11:10:59.204	2005/09/14 11:10:58.917	server1	nm	3	Resource lanhb2 of server server2 up.
🔊	2005/09/14 11:11:01.680	2005/09/14 11:10:58.917	server1	nm	3	Resource comhb1 of server server2 up.
🔊	2005/09/14 11:11:01.607	2005/09/14 11:10:58.917	server1	nm	3	Resource lanhb1 of server server2 up.
🔊	2005/09/14 11:10:59.844	2005/09/14 11:10:57.460	server1	mdadm	6	Building of switch mirror disk has finished successfully.(Device: md2)
🔊	2005/09/14 11:10:59.394	2005/09/14 11:10:56.902	server1	nm	3	Resource lanhb2 of server server2 up.
🔊	2005/09/14 11:10:57.139	2005/09/14 11:10:56.902	server1	nm	1	Server server2 up.
🔊	2005/09/14 11:10:59.283	2005/09/14 11:10:56.902	server1	nm	3	Resource lanhb1 of server server2 up.
🔊	2005/09/14 11:10:57.024	2005/09/14 11:10:56.807	server1	mdadm	6	Building of switch mirror disk has finished successfully.(Device: md1)
🔊	2005/09/14 11:10:52.250	2005/09/14 11:10:53.485	server1	mdw	7	Recovery mode is FAST mode.(Device: md1)
🔊	2005/09/14 11:10:53.007	2005/09/14 11:10:51.593	server1	mdw	7	Recovery mode is FAST mode.(Device: md2)
🔊	2005/09/14 11:10:51.713	2005/09/14 11:10:51.577	server1	mdw	17	Recovery started.(Device: md2)
🔊	2005/09/14 11:10:51.130	2005/09/14 11:10:50.838	server1	mdw	17	Recovery started.(Device: md1)
🔊	2005/09/14 11:09:57.655	2005/09/14 11:09:57.317	server1	rm	1	Monitor pidw2 start.

For the meanings of alert messages, see “Messages reported by event log and alert” in Chapter 12, “Error messages” in this guide. For information about searching alert messages, see “Searching for an alert by using the WebManager” on page 31.

Alert view fields

The meaning of each of the fields in the alert view of the WebManager are the following.

- (1) Alert type icon

Alert type	Description
	Informational message
	Warning message
	Error message

- (2) Alert received time

The time the alert was received. The time in the server to which the WebManager connects is applied.

- (3) Alert sent time

The time the alert was sent from a server. The time in the alert sender server is used.

- (4) Alert sender server

The name of a server that sent the alert.

- (5) Alert sender module

The name of a module that sent the alert.

For a list of module name types, see “Searching for an alert by using the WebManager” on page 31.

- (6) Event ID

The event ID number set to each alert.

- (7) Alert message



The alert messages.

Alert view operation

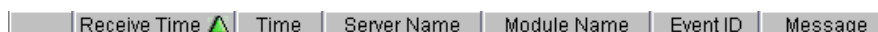
By clicking an item on the bar showing name of each field, you can change the alert order.



Whenever you select an item, the  or  mark is displayed in each field.

Mark	Purpose
	Sorts alerts in the ascending order of the selected field.
	Sorts alerts in the descending order of the selected field.

By default, alerts are displayed in the **Time** descending order.

When you right-click this bar, the following pop-up window is displayed so that you can select the items to be displayed. All items are selected by default.

	Received Time	Time	Server Name
	2008/09/22 21:10:10.733	21:10:10.704	server4
	2008/09/22 21:16:10.637	21:16:10.637	server4
	2008/09/22 21:16:10.569	21:16:10.569	server4
	2008/09/22 21:15:55.830	21:15:55.830	server4
	2008/09/22 21:15:55.725	21:15:55.725	server4
	2008/09/22 21:15:55.614	21:15:55.614	server4
	2008/09/22 21:15:55.555	21:15:55.555	server4
	2008/09/22 20:42:09.602	20:42:09.602	server1
	2008/09/22 20:41:44.408	20:41:44.408	server1
	2008/09/22 20:41:44.310	20:41:44.310	server1
	2008/09/22 20:41:43.571	2008/09/22 20:41:43.440	server1

When you double-click the displayed alert, the following window is displayed where you can check the detail of the alert,

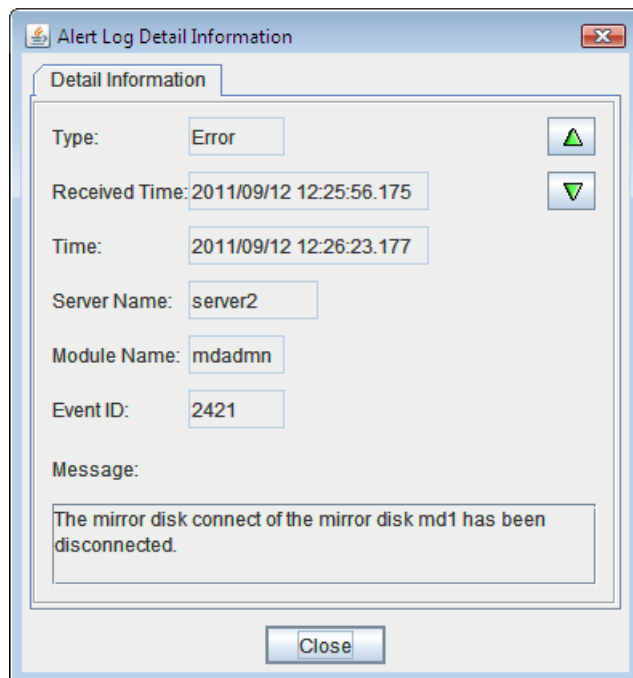

When you right-click the alert, the following pop-up window is displayed where you can select the type of the alert to be displayed. All items are selected by default.

	2008/09/22 21:16:10.637
	2008/09/22 21:16:10.569
	2008/09/22 21:15:55.830
	2008/09/22 21:15:55.725
	2008/09/22 21:15:55.614
	2008/09/22 21:15:55.555
	2008/09/22 20:42:09.602
	2008/09/22 20:41:44.408

Mirror disk helper

Overview of the mirror disk helper

The Mirror Disk Helper is a tool to help the recovery of mirror disk/hybrid disk. It is used by starting up from the WebManager. The following shows the layout of the Mirror Disk Helper.

For mirror disk resource

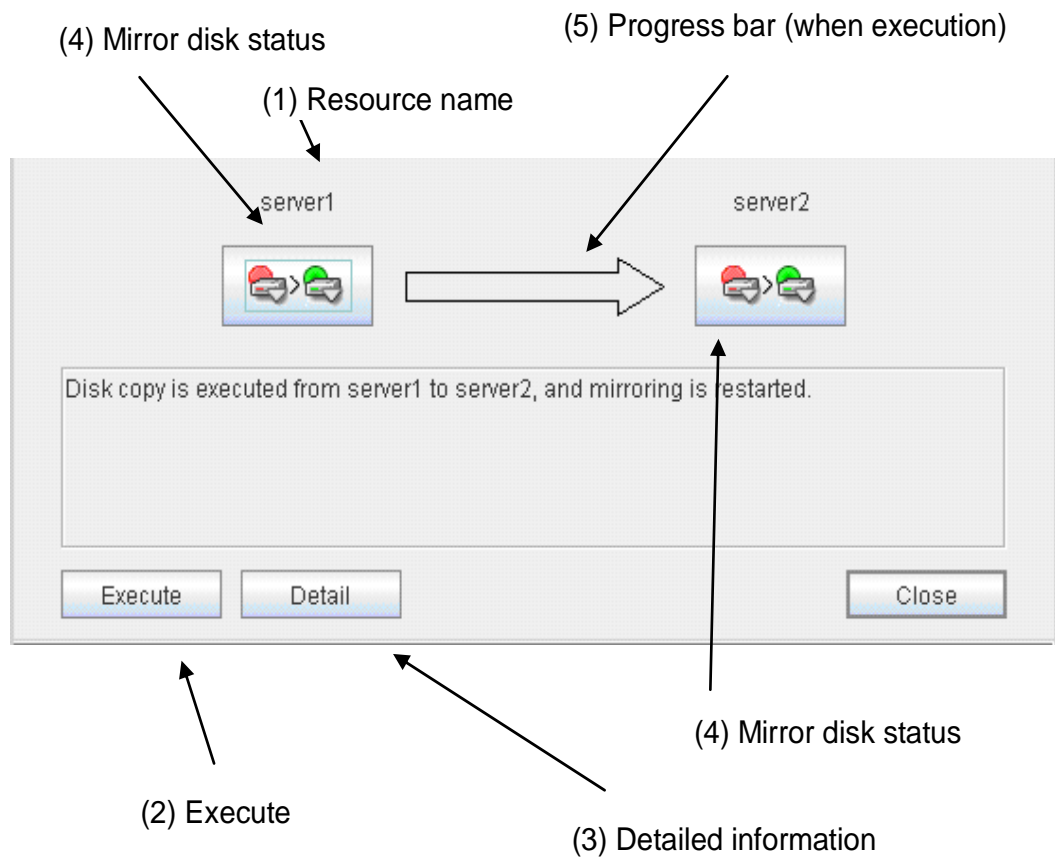

For hybrid disk resource

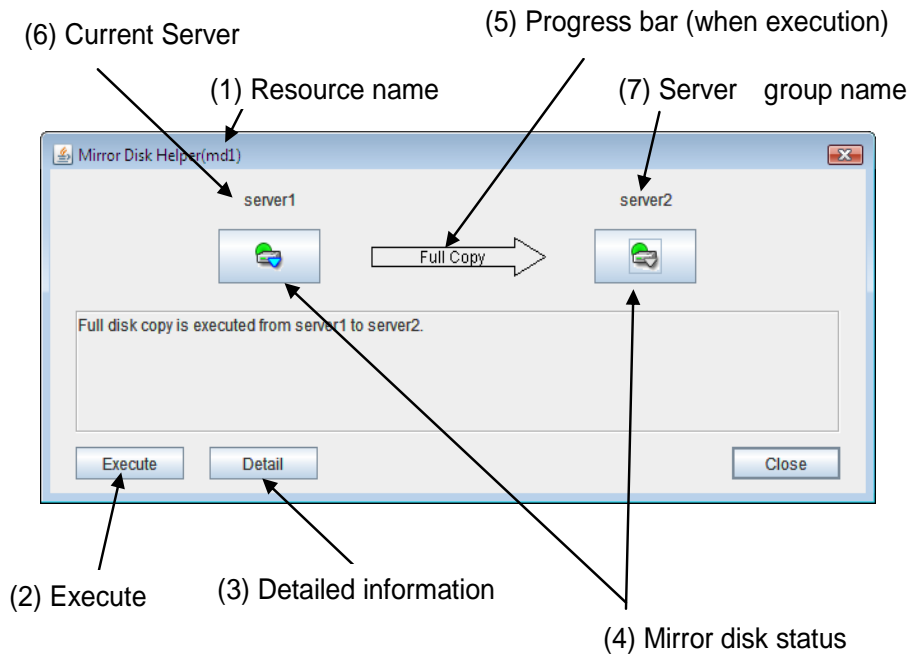

The Mirror Disk Helper can be started by the mirror disk list or a mirror disk resource/hybrid disk resource of a group.

The following is the description of the each field of the Mirror Disk Helper.

(1) Resource name

Displays the name of the mirror disk resource/hybrid disk resource.

(2) Execute

When you click **Execute**, mirror recovery is started as displayed in the following dialog box. If there is any difference between the mirror disks in both servers, the mirror recovery is started.

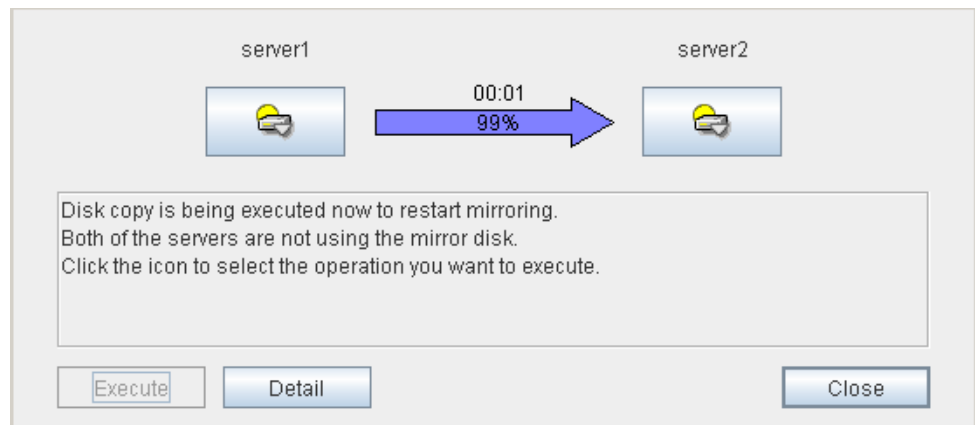

If there is no difference between the mirror disks in both servers, the following dialog box is displayed.



If you click **OK**, full copy of the mirror begins.

If **Auto Mirror Recovery** is set to **On**, mirror recovery begins automatically. However, mirror recovery does not begin automatically if there is no difference between both servers or if there are errors in the mirror disks on both servers.

(3) Detailed information

When you click **Details**, detailed information is displayed.

For mirror disk resource

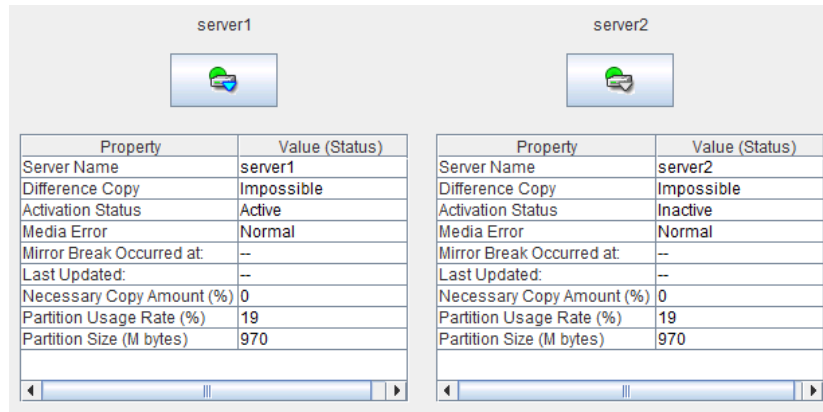

- | | |
|----------------------------|--|
| Server Name: | Server name |
| Difference Copy: | Whether differential copying of the mirror disk resource is possible |
| Activation Status: | Active status of the mirror disk device on the server |
| Media Error: | Media error of the mirror disk resource |
| Mirror Break Occurred at: | Mirror break time |
| Last Updated: | The time that the data was updated the last time |
| Necessary Copy Amount (%): | Amount of data to be copied again to resume mirroring |
| Partition Usage Rate (%): | Partition usage rate |
| Partition Size (M bytes): | Partition size |

For hybrid disk resource

Property	Value (Status)
Server Group Name	svg1
Current Server Name	server1
Difference Copy	Impossible
Activation Status	Active
Mirror Break Occurred at:	--
Last Updated:	--
Necessary Copy Amount (%)	0
Partition Usage Rate (%)	2

Property	Value (Status)
Server Group Name	svg2
Current Server Name	server2
Difference Copy	Impossible
Activation Status	Inactive
Mirror Break Occurred at:	--
Last Updated:	--
Necessary Copy Amount (%)	0
Partition Usage Rate (%)	2

Server Group Name:

Current Server Name:

Differential Copy:

Activation Status:

Mirror Break Occurred at:

Last Update:

Necessary Copy Amount (%):

Partition Usage Rate (%):

Server group name

Name of the server that uploads and manages the disks in the server group.

Whether differential copying of the mirror disk resource is possible

Active status of the mirror disk device on the server

Mirror break time

The time that the data was updated the last time

Amount of data to be copied again to resume mirroring

Partition usage rate









Last Data Update Time is displayed when only one of the servers is updated. **Mirror Break Time** is displayed when mirror connect is disconnected.

Partition Usage Rate is displayed for the server of which resources are active.

(4) Mirroring disk status

The following table shows the mirroring disk status of servers:

You can select what to perform for the mirror disk by clicking the icon.

Icon	Mirroring disk status	Mirror color*
	Mirroring status is normal. The server is inactive.	Green
	Mirroring status is normal. The server is active.	Green
	Mirror recovery or forced mirror recovery is underway. The server is inactive.	Yellow
	Mirror recovery or forced mirror recovery is underway. The server is active.	Yellow
	There might be a difference, but it has not been determined which has the latest information. Mirror recovery is required.	Orange
	The server has an error. Mirror recovery is required.	Red
	The server is stopped or its status is unknown. Information on the server status cannot be acquired.	Gray
	Both systems are active.	Blue
	Cluster partition has an error.	Black

- To see the mirror color, run the `clpmdstat` command.

(5) Progress bar

When performing the mirror recovery, the progress bar shows an arrow from a source server with the latest data to a copy destination server.

How far the mirror recovery has progressed and expected time required for copying are displayed in the progress bar.



(6) Current server (only hybrid disk resource)

Current server displays the current server that updates and manages the disks. You can check the status of each member server of the server group by clicking the drop-down arrow. The current server is represented in the bold font. The server represented in gray font is in the down state.

When performing mirror recovery or cancelling access restrictions, you can select a server from the list shown by clicking the drop-down arrow to change a current server.

(7) Server group name

The server group name is displayed. For more information on server groups, refer to "Understanding server groups" in Chapter 5, "Group resource details" in this guide.

Recovering a mirror (forcefully)

1. Mirror recovery

If there is a difference between the mirror disks on both servers:

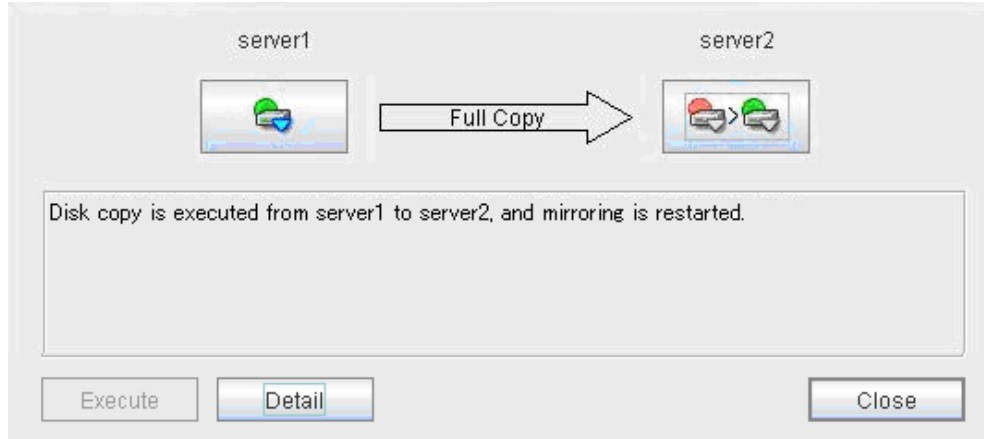

If there is a difference between the mirror disks on both servers, and one of the servers has an error, the progress bar direction is fixed. When you click **Execute**, mirror recovery starts.

When you click **Execute**, mirror recovery starts. If any group is active, the server with the active group becomes the source server. When it is possible to recover differences, only the difference is recovered. If it is impossible to recover differences, whole partition area is recovered.

If there is no difference between the mirror disks on both servers:

If there is no difference, full copy of the mirror is performed.

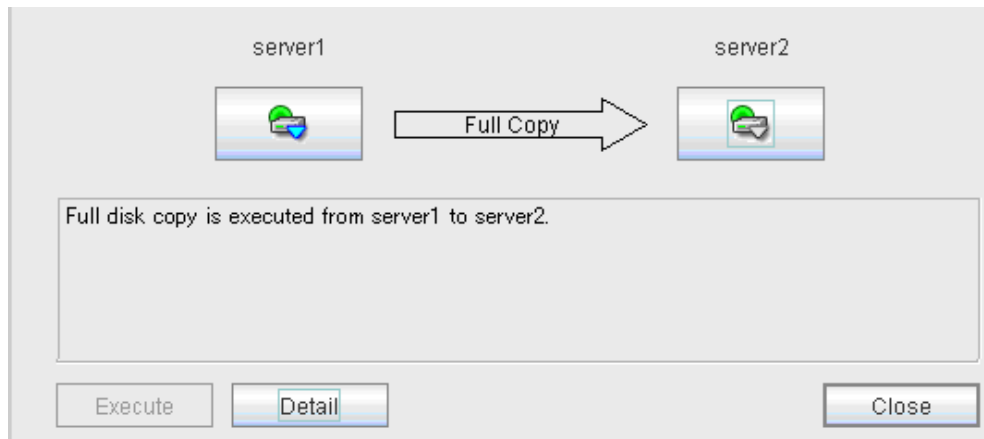

If there is no difference between the mirror disks of both servers, and both servers are running normally, the progress bar is displayed. When you click **Execute**, mirror recovery starts.

If the status of both servers is Error:

If both servers have errors, click **Details** to determine a source server. When you click **Details**, the following detailed information is displayed.

The screenshot displays the Mirror disk helper interface with two server panels, 'server1' and 'server2'. Each panel contains a table of properties and their values. Below the tables is a status message and control buttons.

Property	Value (Status)
Server Name	server1
Difference Copy	Impossible
Activation Status	Inactive
Media Error	Normal
Mirror Break Occurred at:	2010/08/26 15:04:20
Last Updated:	2010/08/26 15:04:20
Necessary Copy Amount (%)	19
Partition Usage Rate (%)	19
Partition Size (M bytes)	970

Property	Value (Status)
Server Name	server2
Difference Copy	Impossible
Activation Status	Inactive
Media Error	Normal
Mirror Break Occurred at:	2010/08/26 15:04:44
Last Updated:	2010/08/26 15:05:04
Necessary Copy Amount (%)	19
Partition Usage Rate (%)	19
Partition Size (M bytes)	970

Mirror disk is not mirroring now.
There is no server that contains the latest data.
Both of the servers are not using the mirror disk.
Click the icon to select the operation you want to execute.

Execute Simple Close

Check the **Last Data Update Time**, and choose a server with the latest data as the source server. Note that the time you see here is of the OS.

If you select an icon whose status is mirrored disk as the source, the progress bar is displayed. Click **Execute** to start mirror recovery.

2. Forced mirror recovery only for a single server

When one server has an error while the other is in the unknown status or stopped, the Mirror Disk Helper is displayed.

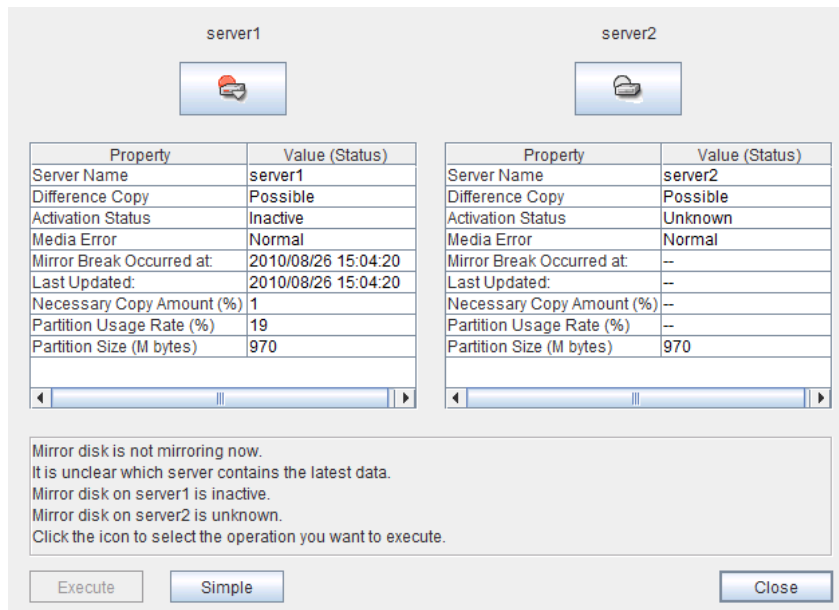

When you click the icon of the server with an error, the following is displayed:

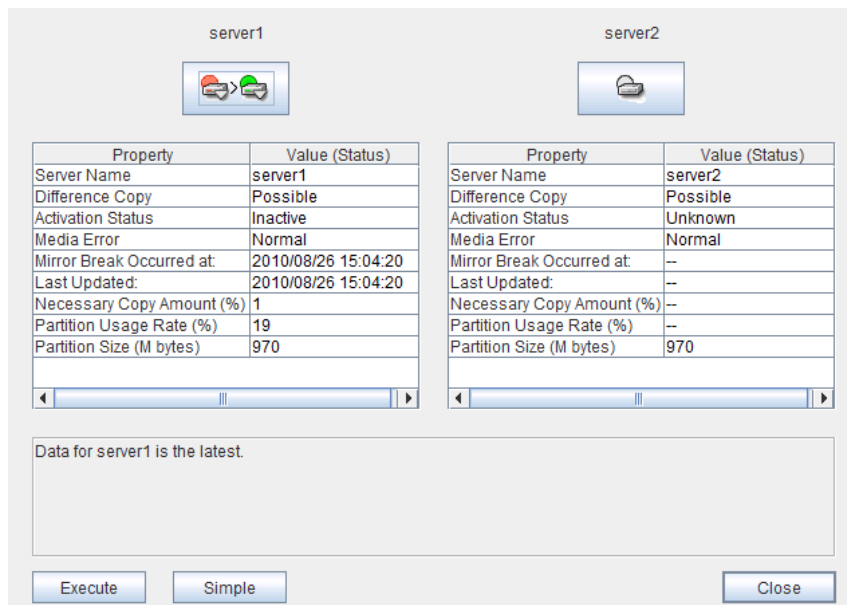

When you click **Execute**, forced mirror recovery of only one server starts.

Stopping mirror recovery

What is similar to the following is displayed during mirror recovery:

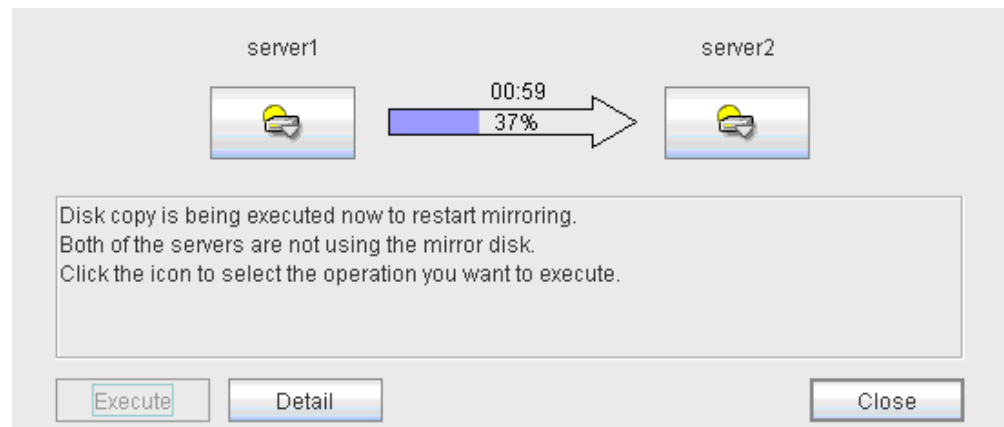

When you click the icon of the server where data will be copied to or from, the following is displayed:

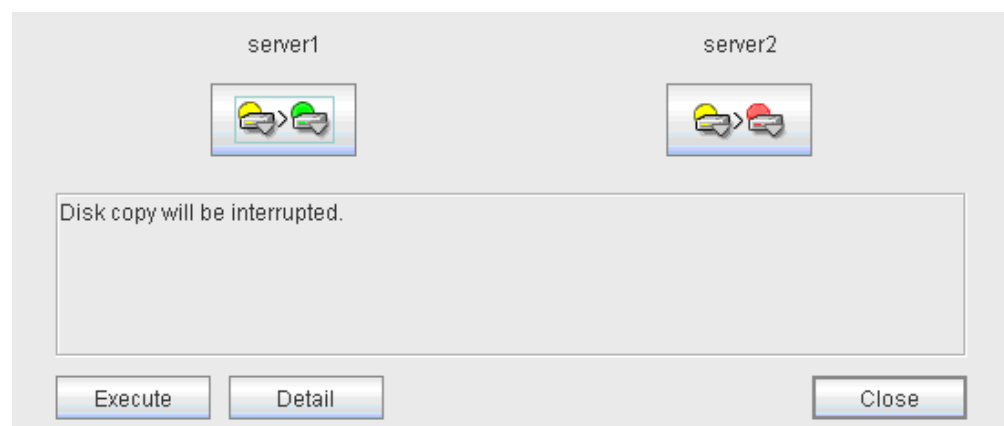

When you click **Execute**, the following dialog box is displayed. If you click **OK**, mirror recovery stops. The server where data is copied from becomes normal status and copied to become error status:

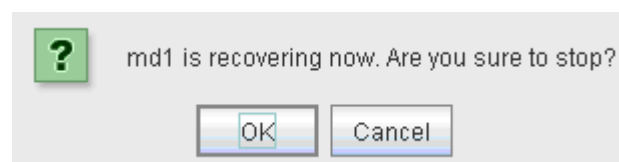

Canceling access restriction

Canceling the access restriction can be performed only when the status of server is error. When the status of one server is normal and other server is error, the following is displayed:

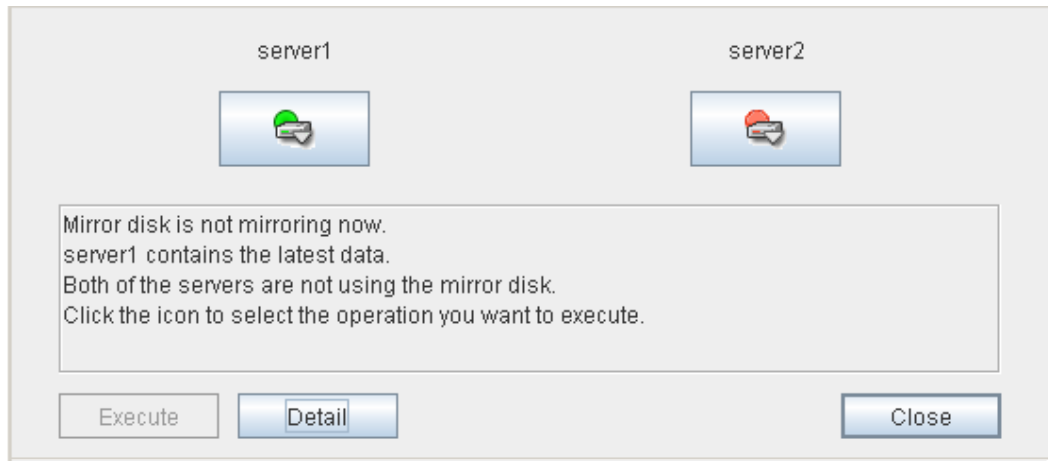

When you double-click the icon of the server with error, the following is displayed:



When you click **Execute**, access restriction is canceled in the server with an error.

To perform mirror recovery, click the icon of the server for which the access restriction is canceled, perform access restriction, and then follow the procedures in “Recovering a mirror (forcefully)” on page 90.

Note:

When the Auto Mirror Recovery is enabled and one of the servers is operating normally, it is necessary to disable Auto Mirror Recovery in advance or suspend the mirror disk monitor resource or hybrid disk monitor resource so that Auto Mirror Recovery does not operate when the access restriction is canceled in the server that is abnormal.

Manually stopping and starting the WebManager

Once EXPRESSCLUSTER is installed, the WebManager automatically starts and stops along with the operating system.

If you wish to stop and start the WebManager specifically, just stop or start the service for the WebManager from the Services console of Administrative Tools.

When you do not want to use the WebManager

If you do not want to use the WebManager for security reasons, change the settings of **Services** of **Management Tool** of your OS or that of the Builder not to start the WebManager.

To specify the settings by using **Service** of **Management Tool**, change the **Startup Type** of the EXPRESSCLUSTER Manager service to **Manual**.

The WebManager can be configured on the **WebManager** tab in **Cluster Properties** of the Builder. For information on how to configure and apply the settings, see “**WebManager tab**” on page 167.

Setting limitations on the connection and operation of the WebManager

The limitation in connection and operation of the WebManager can be configured in **Cluster Properties** in the Builder. For details, see “**WebManager tab**” on page 167.

Type of limitation

There are two ways to set usage limitations:

- ◆ Limiting the access by using client IP addresses
- ◆ Limiting the operation by using a password

Limiting the access by using client IP addresses

This function limits the clients who can access the WebManager and operations on the WebManager by using client IP addresses.

Add IP addresses to **IP Addresses of the Accessible Clients** on the **WebManager** tab in **Cluster Properties** of the Builder. For details, see “WebManager tab” on page 167.

When setting the limitation of the connection of the WebManager, if you attempt to access to the WebManager from the IP address that is not added to **IP Addresses of the Accessible Clients**, the following error messages are displayed.

Example: when using the Internet Explorer

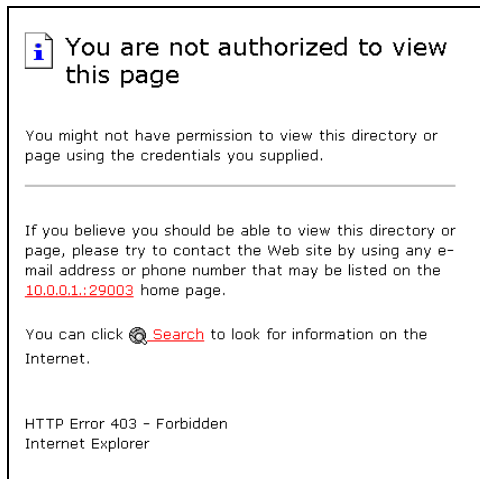

When connecting to the WebManager from the client of which the operation is limited, WebManager becomes **Reference only** and is not able to switch to **Operation Mode** nor **Verification mode**.

The limitation by using a password

This function limits viewing and operations on the WebManager by using a password.

To configure this limitation: in **Cluster Properties** of the Builder, click the **WebManager** tab and then **Control connection by using password**. For details, see “WebManager tab” on page 167.

Once password limitation of the WebManager is set, the following authorization dialog box is displayed when trying to access the WebManager by setting a password.

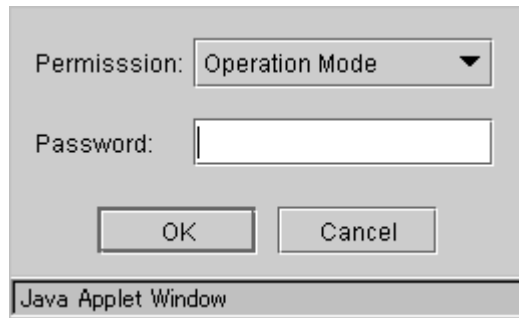

You can log on to the WebManager by selecting **Operation Mode** or **Reference Only** in **Authorization** and entering a correct password.

- ◆ The authorization dialog box is not displayed when the password limitation is not configured (you can log on to the WebManager without authorization).
- ◆ You cannot log on to the WebManager if you enter a wrong password three consecutive times.

When you log in with **Reference Only** selected for **Permission**, the WebManager is placed in reference mode. When you attempt to switch to operation mode, config mode, or verification mode in this status, the above authorization dialog is displayed, and you are requested to enter a password for **Operation Mode**.

Combination of the IP address and password

The operational limitations when using both IP addresses and passwords are the following:

	Password limitation		
Client IP address limitation	Operable mode	Reference only	Unable to operate/view (authorization failed)
Operable Mode	Operable mode	Reference only	Unavailable
Reference Only	Reference only*	Reference only	Unavailable
Cannot Access	Cannot access	Cannot access	Cannot access

* Authorization cannot be selected.

Operating a cluster by using the WebManager

Cluster shutdown and cluster shutdown reboot

For information on how to perform cluster shutdown and cluster shutdown reboot from the WebManager, see “Objects of the cluster” on page 59.

Mirror disk resource and hybrid disk resource

For information on how to use the mirror disks, hybrid disk resources, and Mirror Disk Helper from the WebManager, see “Server object” on page 60 and “Objects of mirror disk resource and hybrid disk resource” on page 66.

Recovering servers

When **Auto Return** is set to **Off** on the **Auto Recovery** tab in **Cluster Properties** of the Builder, and a server is shut down or rebooted without using the cluster shutdown command, the server is started in the suspension (isolated) state. A server in this status does not run as a part of the cluster system. Thus, you need to return the server to the cluster system after you have finished the necessary maintenance work on the server. For more information on how to return a server to a cluster system by using the WebManager, see “Individual server objects” on page 62.

Shutting down and rebooting an individual server

For information on how to shut down and reboot an individual server from the WebManager, see “Individual server objects” on page 62.

Starting, stopping, and moving an individual group

For information on how to start, stop, and move an individual group from the WebManager, see “Individual group objects” on page 64.

Starting and stopping a group resource

For information on how to start and stop a group resource from the WebManager, see “Individual group resource objects (except mirror disk resources and hybrid disk resources)” on page 65.

Resuming, suspending, and stopping dummy failure of monitor resources

For information on how to resume, suspend, or stop dummy failure of a monitor resource from the WebManager, see “Individual group resource objects (except mirror disk resources and hybrid disk resources)” on page 65.

Resuming, suspending, starting dummy failure, and stopping dummy failure of an individual monitor resource

For information on how to resume, suspend, start or stop dummy failure of a monitor resource from the WebManager, see “Individual group resource objects (except mirror disk resources and hybrid disk resources)” on page 65.

Limitations of the WebManager

- ◆ Information displayed by the WebManager does not always reflect the latest status. To acquire the latest information, click the **Reload** icon on the toolbar or **Reload** in the **Tool** menu.
- ◆ If a server fails while the WebManager is acquiring information, the information acquisition fails, which may result in the failure to show some objects.
- ◆ Wait for the next automatic update, or click the **Reload** icon on the toolbar or **Reload** in the **Tool** menu to reacquire the latest information.
- ◆ The EXPRESSCLUSTER logs cannot be collected from two or more WebManager instances simultaneously.
- ◆ If you work on the WebManager when no connectivity is established, it may take a while to regain control.
- ◆ While the mouse pointer is the hourglass which indicates that the OS is processing something, moving the cursor outside the browser may return to the arrow icon even if the process is still underway.
- ◆ If a proxy server is used, configure the proxy server so that the port number of the WebManager can be relayed.
- ◆ When a reverse proxy server is used, the WebManager does not run normally.
- ◆ When you update EXPRESSCLUSTER, close the browser. Clear the cache of Java and restart the browser.
- ◆ If the client PC to connect to WebManager uses Java Runtime Environment (JRE) 7 Update 25 or later, and cannot be connected to the Internet, it may take time to start WebManager. This can be avoided by setting Execute Certificate Revocation Check to Not Check on Detailed Settings on the Java Control Panel. For details of how to set it, check the Java website.

Error messages on the WebManager

The following is a list of error messages displayed when using the WebManager.

Level	Message	Cause	Solution
Info	Alert Service is already started.	The status of the alert service became normal.	-
Error	Alert service is inactive.	Starting the alert service failed.	Check the configuration of alert-related modules.
Error	Could not start the group because necessary responses have not been made.	No status can be acquired because the EXPRESSCLUSTER is now being started up.	Try reloading the status later.
Error	Could not connect to the server.	Connecting the WebManager to the EXPRESSCLUSTER server failed.	Check if the destination server is running.
Error	Connection Timeout.	Internal timeout occurred.	Internal timeout may occur when a time-consuming task is performed. Check the status after the timeout and if there is no problem, operations can be continued.
Error	Connection is terminated.	The connection between the WebManager and the EXPRESSCLUSTER is disconnected.	Check if the connection destination server has failed.
Error	Could not activate some resources.	Failed to start some resources under the group.	Solve the problem that caused the resource error. See the alert log for the detailed information on the error.
Error	Could not deactivate some resources.	Failed to stop some resources under the group.	Solve the problem that caused a resource error. For details on the error, see the alert log.
Error	Failed to collect logs from the server.	Failed to collect logs. Some servers may have been shut down during the log collection. Some servers may not be able to be accessed due to error.	Retry log collection. If logs from a certain server cannot be collected, run the <code>clplogcc</code> command on the server to collect logs.
Error	Failed to connect to server({0} : {1}).	Failed to connect to the WebManager.	Check if the EXPRESSCLUSTER Web Alert service is running on the server.
Error	Failed to find group online server.	Failed to detect the server whose group is online.	The server status may have changed during the operation. Reload the status.
Error	Failed to get data for the cluster tree view from the server.	Failed to acquire the cluster configuration.	Check if EXPRESSCLUSTER is running on the server by using a command.

Level	Message	Cause	Solution
Error	Failed to get the latest alert log.	1) The alertlog.alt file does not exist or is corrupted. 2) The maximum number of the alert viewer records in the cluster configuration data is over the limitation. (Up to 999)	1) Temporarily store all the files under the /installation_path/alert/log on the server, and then restart the alert synchronization service. 2) Check the maximum number of the alert viewer records set in the Builder.
Error	Failed to get property from the server.	Failed to acquire a cluster property value.	Run a command on the server to check if EXPRESSCLUSTER is running.
Error	Failed to search the alert logs.	Failed to open alert log files on a server.	Temporarily store the files under the /installation_path/alert/log on the server, and then restart the alert synchronization service.
Error	The response content is invalid.	Connection to the server is disconnected.	Check the server operating status and network connectivity.
Error	Failed to move group "Group Name" to server "Server Name".	Moving the group failed. [Group Name] group_name [Server Name] server_name	Solve the problem that failed to move the group. For the detailed information on the error, see the alert log.
Error	The group is already started.	The group which is the target of the operation has already been started. Another manager or command on the server may have performed operations on the same group.	Try reloading the group status later to update it, and then perform operations on the group.
Error	The group is already stopped.	The group which is the target of the operation has already been stopped. Another manager or command on the server may have performed operations on the same group.	
Error	Group is updating its status.	The status of the group which is the target of the operation is changing. Another manager or command on the server may have performed operations on the same group.	
Error	Internal error.	An internal WebManager error occurred.	Perform reloading. If the same error occurs even after reloading, restart the EXPRESSCLUSTER Web Alert service.
Error	Invalid configuration data.	Failed to acquire the cluster configuration data.	Check the information on the cluster configuration.
Error	Invalid group name.	An internal error of the WebManager occurred.	Perform reloading.
Error	Invalid group name or server name.	An internal error of the WebManager occurred.	If the error occurs even after reloading, restart the EXPRESSCLUSTER Web Alert service.
Error	Invalid parameter.	An internal error of the WebManager occurred.	

Level	Message	Cause	Solution
Error	Invalid server name.	An internal error of the WebManager occurred.	
Error	An error occurred in server or group operation.	Some operations failed.	Run a command to check the server status. If there is no problem, operations can be continued.
Error	Operatable group does not exist.	The operation to the group failed.	Solve the problem that caused the failure of the operation to the group. For the detailed information on the error, see the alert log.
Error	Enter the number of alert logs displayed on each page.	The number of the alert log filter result to be displayed (for example, the number of logs in a window) is not set.	Specify the number of the alert log filter result to be displayed.
Error	Enter the event ID.	The ID for alert log search is not set.	Specify the ID for alert log search.
Error	Enter the module name.	The name of the module for the alert log search is not set.	Specify the name of a module for the alert log search.
Error	Enter the number of searches.	The number of alert logs to be searched is not set.	Specify the number of alert logs to be searched for.
Error	Enter the page number.	The page to show the results of the alert log research is not set.	Specify the page to show the results of the alert log research.
Error	Enter the server name.	The name of a server for alert log search is not set.	Specify the name of the server to be searched for.
Error	The selected server is invalid.	The server specified as the destination for moving the group is invalid.	Wait for a while to perform reloading to update the group status, and then perform the operation to the group.
Error	Specified server is not active.	The server that initiated the operation is not active.	Wait for a while to perform reloading to update the group, and then perform the operation.
Warning	The cluster tree obtained from the server may not be complete.	An error occurred while acquiring the server status.	Try reloading later.
Error	The number of alert logs per page you have entered is not in the specified range (1 to {0}).	The specified number of alert log filter results displayed per page is out of the range.	Specify a value between 1 and 300.
Error	The value in "To" is incorrect.	The time specified for end of alert log search is invalid.	Set a correct time.
Error	Event ID entered is less than 1.	The ID set for alert log search is smaller than one.	Specify a value of 1 or greater.
Error	There are no groups that can be started.	Failed to start up a group.	Solve the problem that caused the failure of the operation to the group. For the detailed information on the error, see the alert log.

Level	Message	Cause	Solution
Error	There are no groups that can be stopped.	Failed to stop the group.	Solve the problem that caused the failure of the operation to the group. For details on the error, see the alert log.
Error	There are groups that failed to start.	Some operations failed.	Run a command to check the server status. If there is no problem, operations can be continued.
Error	There are groups that failed to stop.	Some operations have failed.	Run a command to check the server status. If there is no problem, operations can be continued.
Warning	The number of searches entered is less than 1.	The ID set for alert log search is smaller than one.	Specify a value of 1 or greater.
Error	Page number entered is less than 1.	The number of pages specified for the alert log search is smaller than one.	Specify a value of 1 or greater.
Error	The page number entered is greater than the total page number.	The number of pages specified for alert log search is greater than the total page number.	Specify the number that is smaller than the total page number.
Warning	The properties got from server may not be completed.	Failed to acquire some information.	Try reloading later.
Error	There are servers that failed to stop.	There is a server that may have failed to shut down the cluster.	Check if the server is down. If it is not down, check that EXPRESSCLUSTER is running.
Error	The value in "From" is incorrect. Enter the correct value.	The time set for start of alert log search is invalid.	Set a correct time.
Error	The value set in "From" is later than the value in "To".	The time set for start of the alert log search is later than the time set for end.	Set a correct time.
Info	The total number of pages has been changed. The server alert log will be updated.	The number of total pages of alert log filter results is updated. New alerts may have been issued while the search results were being displayed.	To apply added alerts to the search results, close the window displaying the search results and perform search again.
Error	Failed to get mirror disk list from server.	An internal error of the Disk Agent occurred. Communication from the WebManager server to the EXPRESSCLUSTER Web Alert service failed. The process on the server timed out.	Make sure that the Disk Agent is working. If the Disk Agent is not started, reboot the server.

Level	Message	Cause	Solution
Error	Failed to get mirror status.	The Disk Agent failed to acquire mirror disk status. An internal error of the Disk Agent occurred. Communication from the EXPRESSCLUSTER Web Alert service to the Disk Agent has failed. The process in the server timed out.	Check if the Disk Agent is active. If the Disk Agent is not started, reboot the server.
Error	Failed to recover the mirror.	An error occurred while performing mirror recovery.	Make sure that the Disk Agent is operating. If the Disk Agent is not started, restart the server.
Error	Detected disk error while recovering the mirror.	A disk error was detected during the mirror recovery.	Run the <code>clpmdstat --mirror</code> command to check disk error status on each server.
Error	Failed to recover the mirror since mirror status has changed.	Mirror recovery failed because the mirror status is changed after the Mirror Disk Helper dialog box was displayed.	Close this error message dialog box, and the information will be updated.
Confirmation	Data on two disks are identical. Are you sure to execute a mirror recovery?	The mirror disks on both servers have no difference. Do you want to continue mirror recovery?	-
Confirmation	{0} is recovering now. Are you sure to stop?	Do you want to stop mirror recovery?	-
Error	Failed to stop recovery.	Failed to stop the mirror recovery.	The server may be heavily loaded. Start up the Mirror Disk Helper again.
Error	Failed to get recovery status.	Acquiring information on the progress of mirror recovery failed.	The server may be heavily loaded. Start up the Mirror Disk Helper again.
Error	The local applet version does not match the server's. Close the browser and clear the applet cache.	A mismatch between the Java applet and the server occurred because the Java cache remains.	Exit the browser. Clear the cache of Java and restart the browser.
Error	Failed to recover since NMP size of "{0}" is smaller than "{1}".	Data partition size of the source server is larger than that of the destination server when recovering a mirror. The recovery is stopped. Initial mirror may not have been configured properly.	Specify a server as a source whose data partition size is smaller.
Error	Failed to get server list.	Failed to get a server list.	Check log collection from another WebManager is running or not. Restart after another log collection completes.
Error	Server is collecting logs. Try again after log collection is completed.	The server is collecting logs.	Try again after other log collections are completed.

Level	Message	Cause	Solution
Error	Failed to collect logs from the server.	An error occurred while collecting logs.	Check the result in dialog box showing the progress of log collection (See "Collecting logs (clplogcc command)").
Error	Failed to Login (Internal error)	An internal error occurred when logging on to the WebManager.	Try logging on to the WebManager again. Start the EXPRESSCLUSTER Web Alert service if the error still occurs.
Error	Failed to login.	Incorrect password was entered three consecutive times.	Try logging on to the WebManager again with a correct password.
Error	Incorrect password.	Incorrect password was entered.	Enter a correct password.
Error	Authorization failed.	Password was changed while accessing the WebManager.	Try logging on to the WebManager again.
Error	Authorization failed. (Internal error.)	An internal error occurred when accessing to the WebManager.	Try logging on to the WebManager again. Reboot the EXPRESSCLUSTER Web Alert service if the error still occurs.
Error	Failed to connect to the server.	Failed to communicate with the WebManager.	Check if the EXPRESSCLUSTER Web Alert service is working on the server. Check if connecting to the server can be performed successfully.
Error	Failed to get the list of mirror disk error.	Disk Agent failed to get the information on the mirror disk. Internal error of the Disk Agent occurred. The access to the Disk Agent from the EXPRESSCLUSTER Web Alert service failed. The processing timed out on the server.	Check if the Disk Agent is operating. If the Disk Agent is not operating, restart the server.
Error	Failed to get the data for the cluster tree view from the server.	Failed to get the cluster data of the destination server. Failed to get all cluster data in the cluster tree view.	Check if EXPRESSCLUSTER is operating by running a command on the destination server Check if all cluster management IPs in the tree view are running normally.
Error	Another user is performing auto-search now. Try it again later.	Auto-search has already been performed from the other manager.	Retry auto-search later.
Error	Internal error.	An internal error of the WebManager has occurred.	Perform the auto-search again. If an error still occurs, restart the EXPRESSCLUSTER Web Alert service.

Level	Message	Cause	Solution
Error	Not connected to the server now. The settings will be displayed when the connection recovers. Wait for a moment.	Because communication with WebManager failed, the changed setting is applied as soon as the connection is recovered.	Confirm that the EXPRESSCLUSTER Web Alert service is operating on the server side. Confirm that the server is connected normally.
Error	Failed to recover the server "{0}". Click the Reload button, or try again later.	The displayed server status might not be the latest status. The status of the server that was changed by a different operation is not reflected on the display.	Click the Reload button, and retry the operation once the status has been updated.
Error	Failed to migrate group "{0}" to server "{1}".	The displayed group status might not be the latest status. Operation from a different WebManager or operation by means of the <code>clpgrp</code> command might not have been reflected in the group status on the display.	Click the Reload button, and retry the operation once the status has been updated.
Error	Failed to disable dummy failure of monitors. Click the Reload button, or try again later.	The displayed cluster status might not be the latest status. Operation from a different WebManager or operation by means of the <code>clpmonctrl</code> command might not have been reflected in the cluster status on the display.	Click the Reload button, and retry the operation once the status has been updated.
Error	Failed to disable a part of dummy failure of monitors. Click the Reload button, or try again later.	The displayed cluster status might not be the latest status. Operation from a different WebManager or operation by means of the <code>clpmonctrl</code> command might not have been reflected in the cluster status on the display.	Click the Reload button, and retry the operation once the status has been updated.
Error	Failed to enable dummy failure of monitor "{0}". Click the Reload button, or try again later.	The displayed cluster status might not be the latest status. Operation from a different WebManager or operation by means of the <code>clpmonctrl</code> command might not have been reflected in the cluster status on the display.	Click the Reload button, and retry the operation once the status has been updated.

Level	Message	Cause	Solution
Error	Failed to disable dummy failure of monitor "{0}". Click the Reload button, or try again later.	The displayed cluster status might not be the latest status. Operation from a different WebManager or operation by means of the <code>clpmonctrl</code> command might not have been reflected in the cluster status on the display.	Click the Reload button, and retry the operation once the status has been updated.
Error	Failed to get the license information.	Failed to obtain the license information.	Check to see the license. Shut down and then reboot the cluster.
Error	The license information obtained from the server may be incomplete.	Part of the license information could not be obtained.	Check to see the license. Shut down and then reboot the cluster.
Error	The request to resume the cluster failed on some servers.	Some servers failed to resume the clusters.	Check the status of the server which failed to resume the clusters.
Error	Failed to get the time info from the server.	The time information could not be obtained.	Click the Reload button, and retry the operation once the status has been updated.
Error	Failed to clear the time info.	Failed to clear the time information.	Click the Reload button, and retry the operation once the status has been updated.

Chapter 2 Function of the Builder

This chapter provides information on functions of the EXPRESSCLUSTER X Builder.

This chapter covers:

- Overview of the Builder 110
- Details on the Builder screen..... 113
- Pop-up menu..... 121
- Using a tool bar of the Builder 122
- Using the menu bar of the Builder..... 123
- File menu..... 123
- View menu 132
- Edit menu 133
- Help Menu 136
- Parameter details 137
- Cluster properties 137
- Servers Properties..... 196
- Server Properties 199
- Parameters list 209
- Upper limits of registration 253

Overview of the Builder

The EXPRESSCLUSTER X Builder is a tool for creating and changing the cluster configuration data (config and/or script) for the EXPRESSCLUSTER Ver3.0 or later.

There are two versions of the Builder; online version and offline version.

- ◆ Online version

To start the Builder, click Config Mode on the View menu or select the config mode icon  from the dropdown menu on the toolbar.

You can also directly connect to the server to create a cluster or change its configuration and distribute the cluster configuration data.
- ◆ Offline version

With the offline version Builder, you can create or change the cluster configuration data on the machine which cannot connect to a server.

To distribute the cluster configuration data, you need to use the `clpcfctrl` command.





Note:

In this guide, Builder refers to both the online version of Builder, which runs in WebManager config mode, and the offline version of Builder, which runs on the management PC.

“Host name” used in this guide represents the short name that excludes the domain name from a frequently qualified domain name (FQDN).

The table below describes the icons in “Using the menu bar of the Builder” and “Parameter details.”

These icons represent the operations required to apply the changes of items to the cluster.

Icon	Priority	How to change	Refer to
	1	Shut down and reboot cluster	The <i>Installation and Configuration Guide</i> Chapter 8, “Preparing to operate a cluster system.”
	2	Stop and restart the cluster daemon	The <i>Installation and Configuration Guide</i> Chapter 8, “Preparing to operate a cluster system.”
	3	Suspend and resume the cluster daemon	The <i>Installation and Configuration Guide</i> Chapter 8, “Preparing to operate a cluster system.”
	4	Stop and resume the group (Stop and resume the resource)	The <i>Installation and Configuration Guide</i> Chapter 8, “Preparing to operate a cluster system.”
	5	Stop and resume the WebManager Stop and resume the alert log	The <i>Reference Guide</i> Chapter 1 “Function of the WebManager”
(No icon)	6	Upload only	The <i>Installation and Configuration Guide</i> Chapter 8, “Preparing to operate a cluster system.”

To form a new cluster, refer to the *Installation and Configuration Guide*.

Considerations for using the Builder

- ◆ The following products' cluster configuration data is not compatible.
 - A Builder other than that of EXPRESSCLUSTER X 3.3 for Windows
 - The Builder of the EXPRESSCLUSTER for Linux
 - The Builder of the EXPRESSCLUSTER for Windows Value Edition
- ◆ Cluster configuration data created using a later version of this product cannot be used with this product.
- ◆ Cluster configuration data of EXPRESSCLUSTER X1.0/2.0/2.1/3.0/3.1/X3.2/X3.3 for Linux can be used with this product.
 - You can use such data by clicking **Import** from the **File** menu in the Builder.
- ◆ If you close the Web browser (by clicking **Exit** on the **File** menu or by clicking **X** on the window frame), the dialog box to confirm to save is displayed.

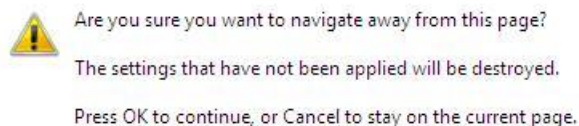

When you continue to edit, click the **Cancel** button.

Note:

This dialog box is not displayed if JavaScript is disabled.

- ◆ Reloading the Web browser (by clicking **Reload** on the **Tool** menu or the **Reload** icon on the toolbar), the dialog box to confirm to save is displayed.

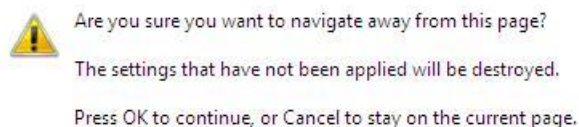

When you continue to edit, click the **Cancel** button.

Note:

This dialog box is not displayed if JavaScript is disabled.

- ◆ Do not specify a number smaller than 30 seconds for **Reload Interval** on the **WebManager** tab (See “WebManager tab” on page 167 for details). If you have to set a smaller number for this field than the default value, test thoroughly to see if it works properly before you start the operation.

Limitations on using the Builder

- ◆ If you change the screen resolution while the Builder is running, the Java VM stack trace (example: NullPointerException) may be logged on the Java console. The Builder can keep running.
- ◆ If you press **Esc** while a pull-down menu of your browser is displayed, the Java VM stack trace (example: NullPointerException) may be logged on the Java console. The Builder can keep running.
- ◆ In some cases, you cannot use the keyboard because the keyboard focus of the Builder becomes disabled (the focus changes to the Web browser). Click the Builder window and get the focus back to the Builder.
- ◆ When you are using the multi-display function, do not run the Builder on the secondary display. Otherwise, it may not work properly. For example, the screen is not displayed. Use the Builder on the primary display.
- ◆ On the **Alert Log** tab (see “Alert Log tab” on page 174), for **Max. Number to Save Alert Records**, if you set a number smaller than the current one, all alert logs will be deleted. Take into account the available disk space, and specify the number before you start the operation.
- ◆ In the environment where Internet Explorer is used, disable **Protected Mode** on the security setting of Internet Explorer.
- ◆ The JIS 2004 unique characters supported by Microsoft Windows Vista® are not supported. You cannot enter or view any character added by JIS 2004.
- ◆ The Builder does not run normally through the Reverse Proxy server.

Details on the Builder screen

This topic explains the Builder screen layout.

Overview of the EXPRESSCLUSTER X Builder

The screen layout of the Builder is displayed below.

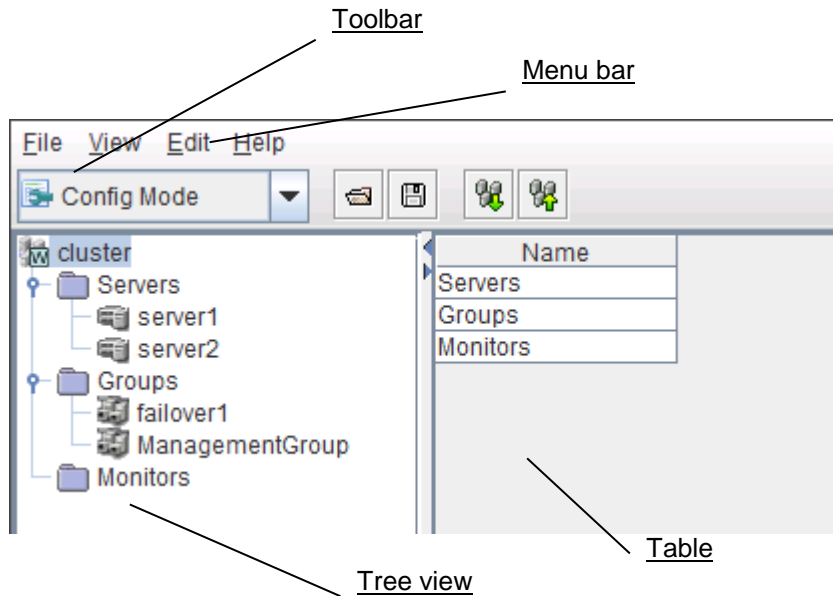

The tree view on the left pane shows the cluster objects in the hierarchical order. If you select an object from the tree view, its subordinate objects are displayed in the table view on the right pane.

Tree view

The following objects are displayed in the tree view:

Hierarchy	Object	Contents	Table view when the object is selected
1	cluster	Represents the cluster.	Displays cluster names.
2	Groups	Represents a set of groups in the clusters	Displays groups.
3	failover1	Represents each group.	Displays group names.
2	Monitors	Represents a set of monitor resources in the clusters	Displays monitors.
2	Servers	Represents a set of servers in the clusters	Displays servers.
3	server1	Represents an individual server.	Displays server names.

Table view

Table for cluster name selection

Displays objects in the root hierarchy.

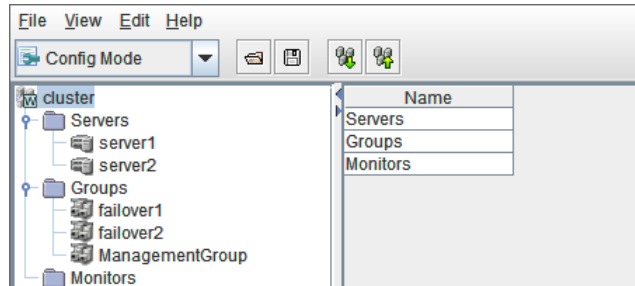
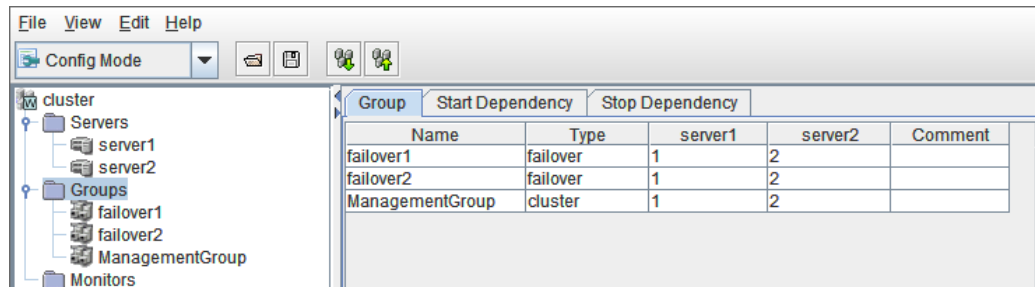

Table for group selection

Group list

Displays the failover priorities of the groups.



Column name	Overview
Name	Displays the group names in alphanumerical order.
Type	Displays the group type.
Server names (The number of columns dynamically increases or decreases according to the number of servers)	Represents the startup order of groups on the servers displayed by column names. The top priority is represented with "1." This is blank if the startup priority is the same as that of the server. This is blank for the WebManager group.
Comment	Displays comments specified for the groups.

Start Dependence

The dependencies included in the group start dependence are listed.

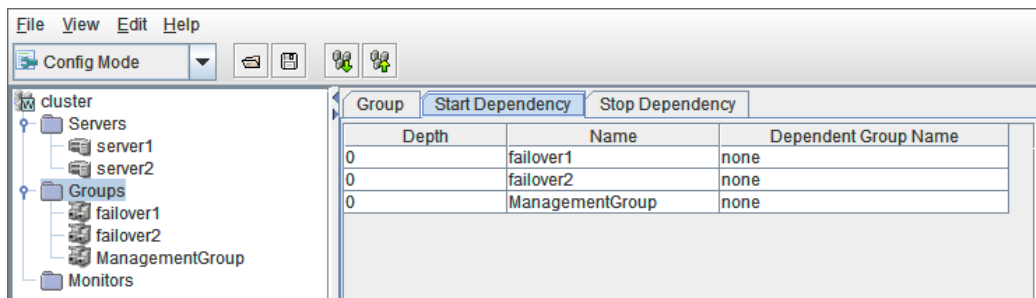

Column name	Overview
Depth	Represents the target start order of groups in the name cells. If start dependence is not applied to any group, "0" is displayed. Groups are displayed in the depth order.
Name	Displays group names.
Dependent Group Name	Displays the group start dependence names in the name cells. If start dependence is not applied to any group, "none" is displayed. If there are multiple start dependence groups, they are displayed on separate rows.

The levels of depth are illustrated below. Arrows (->) in the figure represent group start dependence targets.

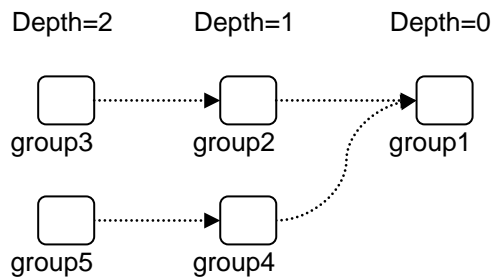

The dependencies represented by this figure are listed below.

Depth	Name	Dependent Group Name
0	group1	none
1	group2	group1
1	group4	group1
2	group3	group2
2	group5	group4

Stop Dependence

The dependencies included in the group stop dependence are listed.

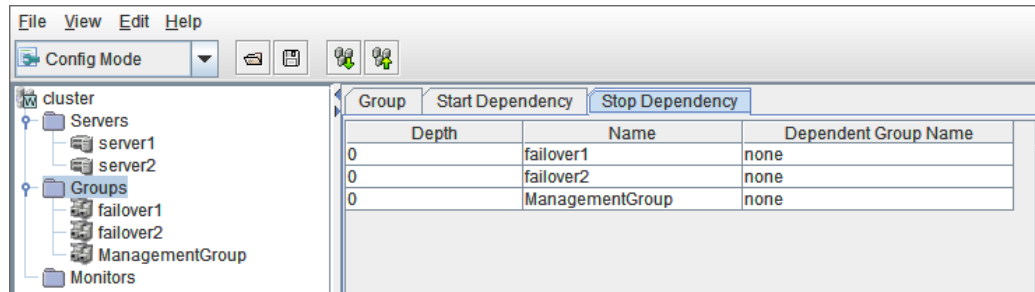

Column name	Overview
Depth	Represents the target stop order of groups in the name cells. If stop dependence is not applied to any group, "0" is displayed. Groups are displayed in the depth order.
Name	Displays group names.
Dependence Group Name	Displays the group stop dependence names in the name cells. If stop dependence is not applied to any group, "none" is displayed. If there are multiple stop dependence groups, they are displayed on separate rows.

The levels of depth are illustrated below. Arrows (->) in the figure represent group stop dependence targets.

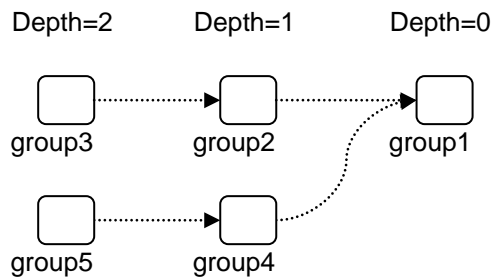

The dependencies represented by this figure are listed below.

Depth	Name	Dependence Group Name
0	group1	none
1	group2	group1
1	group4	group1
2	group3	group2
2	group5	group4

Table for group name selection

Resources

Group resources in the selected group are listed.

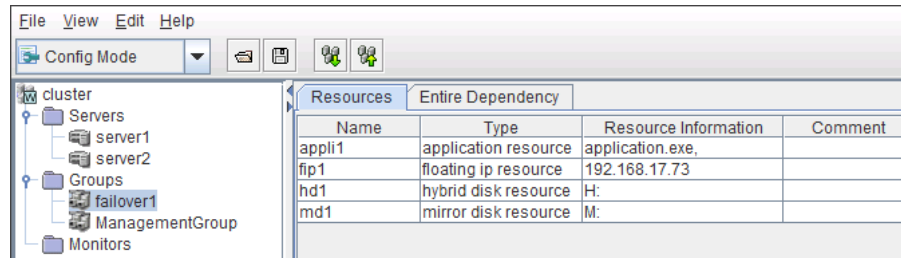

Column name	Overview
Name	Displays group resource names in alphanumerical order.
Type	Displays a group resource type.
Resource Information	Displays objects to be activated or deactivated for the group resource.
Comment	Displays comments specified for the group resource.

Dependency List

Dependency among group resources in a selected group is listed.

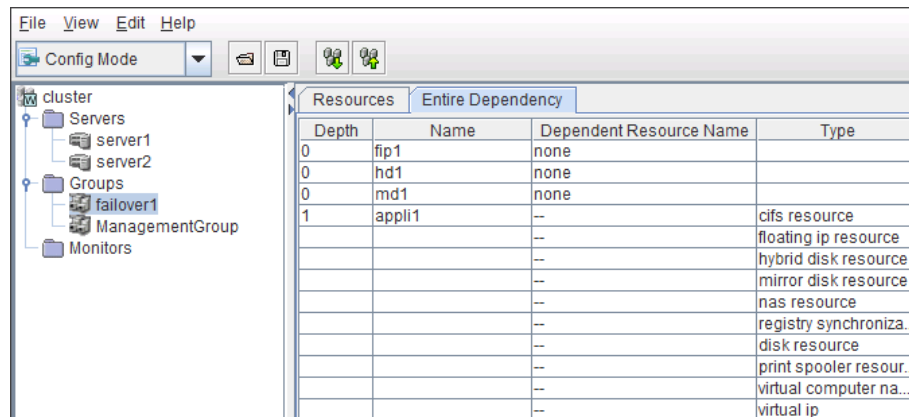

Column name	Overview
Depth	Represents the target activation order of group resources in the name cells. If a group resource does not depend on any group resource, "0" is displayed. Group resources are displayed in the depth order.
Name	Displays the group resource name.
Dependent Resource Name	Displays the group resource names that the group resources in the name cells depend on. If a group resource does not depend on any group resource, "none" is displayed. When following the default dependency, "--" is displayed. If there are multiple dependent resources, they are displayed in separate rows.
Type	Displays the group resource type in Dependent Resource Name. When following the default dependency, the dependent type is displayed.

The levels of depth are illustrated below. Arrows (->) in the figure represent the group resource activation order.

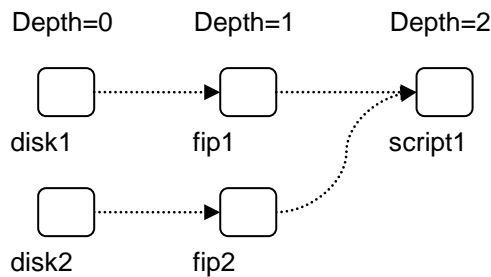

The dependencies in this figure are listed below. These are not the default dependencies, but specified with resource names.

Depth	Name	Dependent Resource Name	Type
0	disk1	none	-
0	disk2	none	-
1	fip1	disk1	disk resource
1	fip2	disk2	disk resource
2	script1	fip1	floating ip resource
-	-	fip2	floating ip resource

Table for monitor resource selection

Displays the list of monitor resources.

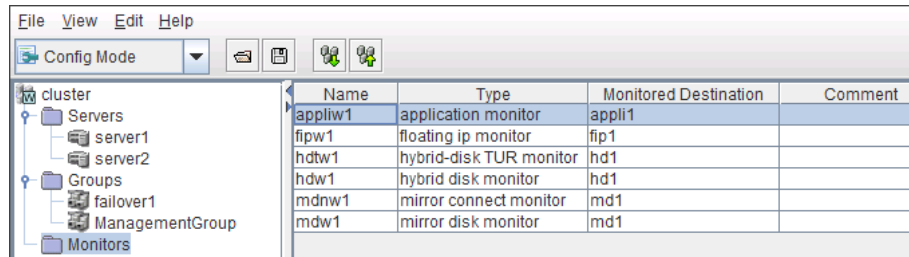

Column name	Overview
Name	Displays monitor resource names in alphanumerical order.
Type	Displays the monitor resource type.
Monitored Destination	Displays the monitor resource to be monitored.
Comment	Displays comments specified for the monitor resource.

Table for server selection

Displays the list of servers.

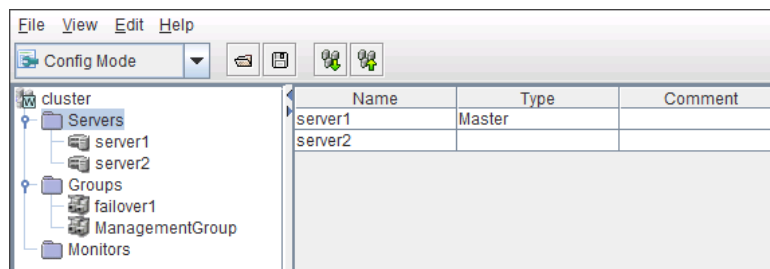

Column name	Overview
Name	Displays server names in alphanumerical order.
Type	If the server is specified as the master server, "Master" is displayed.
Comment	Displays comments specified for the server.

Table for server name selection



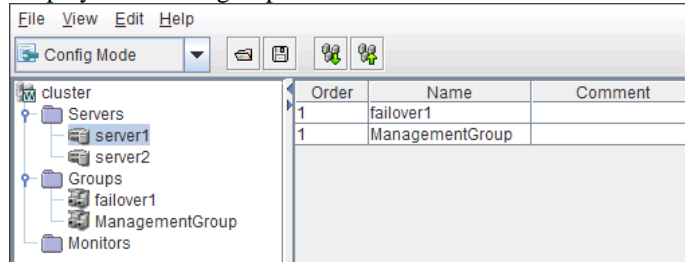



Displays the list of groups allowed to start on the selected server.



Column name	Overview
Order	Displays the server priority. The groups in the name cells start on servers in this order. "1" is displayed for the top priority. This list is displayed in the descending order of priority. This field is blank if the group does not have a specific startup order of servers (if it follows the servers' priorities). The WebManager group is not displayed.
Name	Displays the group name.
Comment	Displays comments specified for the group.

Pop-up menu

Pop-up menus are displayed by right-clicking a tree object or table row.

If select	Displayed menu	Refer to
 <i>no_cluster_name</i>	Cluster Generation Wizard	Creating a new cluster (on page 124)
 <i>cluster_name</i>	Remove Cluster	Removing an object (on page 134)
	Rename Server	Renaming an object(on page 135)
	Properties	Properties (on page 135)
 Servers	Add Server	Adding an object (on page 133)
	Properties	Properties (on page 135)
 <i>server_name</i>	Remove Server	Removing an object (on page 134)
	Rename Server	Renaming an object(on page 135)
	Properties	Properties (on page 135)
 Monitor Resources	Add monitor resource	Adding an object (on page 133)
 Groups	Add Group	Adding an object (on page 133)
 <i>group_name</i>	Add Resource	Adding an object (on page 133)
	Remove Group	Removing an object (on page 134)
	Rename Group	Renaming an object(on page 135)
	Properties	Properties (on page 135)
<i>group_resource_name</i>	Remove Resource	Removing an object (on page 134)
	Rename Resource	Renaming an object(on page 135)
	Properties	Properties (on page 135)
<i>monitor_resource_name</i>	Remove Monitor Resource	Removing an object (on page 134)
	Rename Monitor Resource	Renaming an object(on page 135)
	Properties	Properties (on page 135)

Using a tool bar of the Builder

The Builder provides a toolbar:

◆ Online Version







◆ Offline Version



There is a drop down menu for mode switch on the left side of the toolbar with online version. For details on this menu, see “Window of WebManager Main window of the WebManager Toolbar” in Chapter 1, “Functions of WebManager” on page 29

Click each icon on the tool bar to do the same operation of the some items on the menu bar.

Button	Function	Refer to
	Opens a file. This is the same as clicking File from the menu bar and then selecting Open .	“Opening the configuration file” (on page 124)
	Saves a file. This is the same as clicking File from the menu bar and then selecting Save .	“Saving the configuration file” (on page 125)
	Get the configuration. This is the same as clicking Get the Configuration File on the File menu. This is not available with the offline version.	“Get the configuration file (online version only)” (on page 126)
	Apply the configuration. This is the same as clicking Apply the Configuration File on the File menu. This is not available with the offline version.	“Apply the configuration file (online version only)” (on page 126)

Using the menu bar of the Builder

You can perform various operations by using the menu bar of the Builder. This topic explains the operations to be executed using the menu bar.

File menu

Select **F**ile to display the following menu.

Menu	Function
New File	Creates a new cluster.
Cluster Generation Wizard	Starts the cluster generation wizard.
Import	Read the cluster configuration information file.
Export	Save the configuration information as the cluster configuration information file.
Get the Configuration File	Connect to the cluster and get the current configuration information (online version only).
Apply the Configuration File	Apply the configuration information to the cluster (online version only).
Update Server Data	Update the server IP address and the device information (online version only).
Option	Starts the Option dialog box.
Save Log Files	Starts the Save Logs dialog box.
Exit	Exits the Builder.

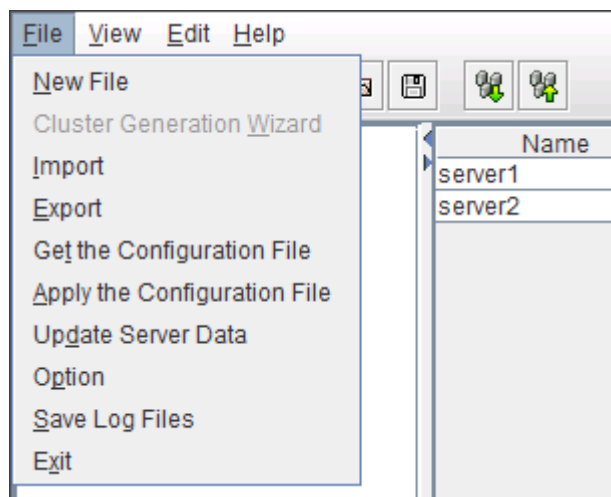

Creating a new cluster

Create a new cluster using the Builder.

Important:

If you create a new cluster, the cluster configuration data that has been edited will be discarded. Be sure to save the required data before you create a new cluster.

1. On the menu bar, click **File** and then click **New File**.
2. If you made changes in the cluster configuration data, a dialog box asks if you want to save them before they are discarded. Click **Yes** to save the changes. A dialog where you can specify a folder to save the cluster configuration data is displayed. If you do not want to save the changes, click **No**. For how to save the data, see “Saving the configuration file” on page 125.
3. On the left pane of the screen on the tree view displayed, right-click the cluster icon and click **Cluster Generation Wizard**. Use the **Cluster Generation Wizard** to create a cluster.

For the **Cluster Generation Wizard**, refer to Chapter 5, “Creating the cluster configuration data” in the *Installation and Configuration Guide*.

Opening the configuration file

Select **Import** to open the saved cluster configuration data. A tree view is displayed by the configuration file that has been read.

Select this to restart editing a temporary file saved while editing the configuration data.

How to use:

1. Click **Import** from the **File** menu.
2. The **Open** dialog is displayed. Select an appropriate configuration file and click **Open**. The data of the configuration file is displayed in the Builder.

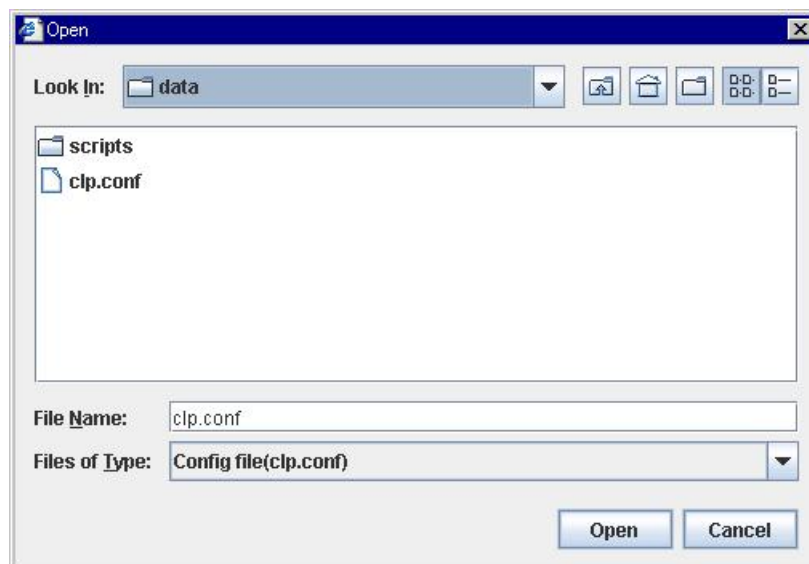

For **File Name**, select or type “clp.conf.”

Saving the configuration file

Click **Export** to save the cluster configuration data you are editing. This menu becomes available if you have created a cluster configuration data. Save the file as “clp.conf.”

To save a cluster configuration data, the following conditions should be satisfied.

- ◆ The server exists.
- ◆ Kernel-mode LAN heartbeat resource exists.

How to use:

1. Select **Export** from the **File** menu.
2. The **Save** dialog is displayed. Select an appropriate place to save the configuration file and click **Save**.

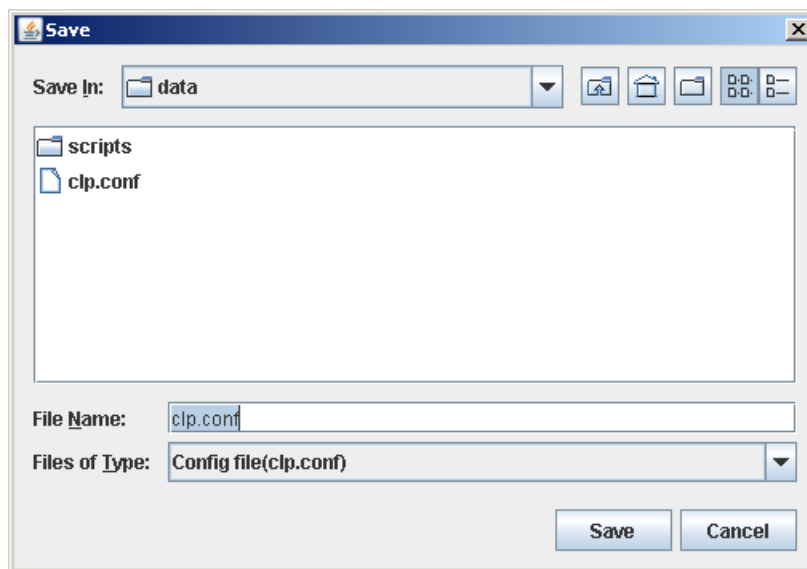

For **File Name**, select or type “clp.conf.”

Note:

When using Builder on the server on which EXPRESSCLUSTER is operated, do not edit etc\clp.conf in the EXPRESSCLUSTER installation path. Otherwise, messages regarding how to apply the changes are not properly displayed, and/or EXPRESSCLUSTER may not work properly. Save the file on a different directory temporarily. When uploading is performed by using the `clpofctrl` command, specify the directory where the file is saved by using the `-x` option.

Get the configuration file (online version only)

Get the cluster configuration data set to the connected server. Tree view is displayed according to the got configuration file,

If any changes have been made in the data which is being edited, a dialog box that asks if you want to save the data is displayed.

Click **Yes** to save the changes. A dialog where you can specify a folder to save the cluster configuration data is displayed. For how to save the data, see “Saving the configuration file” on page 125.

If you do not need to save the changes, click **No**. The cluster configuration that is being edited is discarded and the configuration file is got.

If you want to cancel getting, click **Cancel**.

Note:

Do not create a folder or a file under the <EXPRESSCLUSTER installation path>\scripts on the server. Getting the configuration file may fail if you create a file or a folder.

Apply the configuration file (online version only)

Apply the cluster configuration data that is being edited to the connected server. You can select this menu when you open a valid cluster configuration file.

The following conditions must be satisfied to apply the configuration file.

- ◆ A server exists.
- ◆ A LAN heartbeat resource of kernel mode exists.

Note:

If this condition is not satisfied, connection to the other server will fail, so applying of the cluster configuration data fails. In this case, you can forcibly apply the cluster configuration data only to a server to which connection is possible. For details, see “Creating a cluster (clpcfctrl --push)” in Chapter 3, “EXPRESSCLUSTER command reference” on page 364.

Note:

When using a hybrid disk resource, do not apply configuration information if any part of the server is stopped. If configuration information is applied in this state, an error will be detected in the control module of the hybrid disk resource, possibly causing the server to shut down.

The following message is displayed while applying the cluster configuration data. If the applying the data fails, take an action according to the error message, and apply the data again.

Message	Solution
The apply is completed successfully.	-
Changes applied successfully. Some services have been stopped in order to apply the changes. Use the following steps to resume the stopped services. <Necessary operation> Execute now ?	If you select Yes , indicated operation is carried out.
There is the disk information that is not configured. Are you sure you want automatic configuration?	Some GUID information of the volume is not configured. If you select Yes , automatic configuration is performed by determining the current GUID information from the derive letter.
There is the HBA information that is not configured. Are you sure you want automatic configuration?	The HBA information is not configured for the server where the information of HBA for accessing the shared disk was configured at the time of the installation. If you select Yes , the information configured at the time of the installation is inherited.
There is difference between the disk information in the configuration information and the disk information in the server. Are you sure you want automatic modification?	The combination between the GUID information of the volume and the drive letter does not match with the one on the actual servers. If you select Yes , automatic configuration is performed by determining the current GUID information from the derive letter.
The upload was stopped. There is one or more servers that cannot be connected to. To apply cluster configuration information forcibly, run the clpcfctrl command on the server.	Since there is a server that cannot be connected to exist in the cluster, applying the cluster configuration data has been canceled. Make sure that all the servers in the cluster have been started, and then apply the cluster configuration data. If you want to apply the cluster configuration data forcibly even though there is a server that cannot be connected in the cluster, see "Creating a cluster (clpcfctrl --push)" in Chapter 3, "EXPRESSCLUSTER command reference" on page 364.
An error occurred when applying data to the cluster. Cfctrl (%0)	Since an error has occurred while performing processing, applying the cluster configuration data has been canceled. Apply the data again.
Checking the cluster configuration file failed. Check the following settings. Server Name, IP address for interconnect, IP address for Integrated WebManager	There are differences between the IP addresses included in the cluster configuration information and the IP addresses currently set to each server. Check correct IP addresses are set or not.

Related Information: If a server that cannot be connected exists in the cluster, the cluster configuration information cannot be applied from the Builder. In this case, by running the `clpcfctrl` command, you can forcibly apply the cluster configuration information only on the server that can be connected.

Follow the steps below to forcibly apply the cluster configuration data.

- (1) Save the cluster configuration data to an appropriate directory of the local disk from the Builder.
Example) Save the configuration data to `C:\config`
- (2) Save the cluster configuration data that you have saved on a server in the cluster.

Example) Save the data in C:\config that you have saved in step (1) in the C:\tmp directory on a server in the cluster.

- (3) Run the following command on the server where the cluster configuration data has been saved.

```
clpcfctrl --push -x "Directory where the cluster configuration data has been saved" --force
```

Example) Run the following command on the server where step (2) has been performed.

```
clpcfctrl --push -x "C:\tmp" --force
```

Updating the server information (online version only)

Get the information of the specified server.

The license information is also obtained when getting the IP list or device information. If the license for Java Resource Agent is registered, the **JVM monitor** tab will appear in **Cluster Properties**. You will be able to create resources and monitor resources corresponding to the registered licenses.

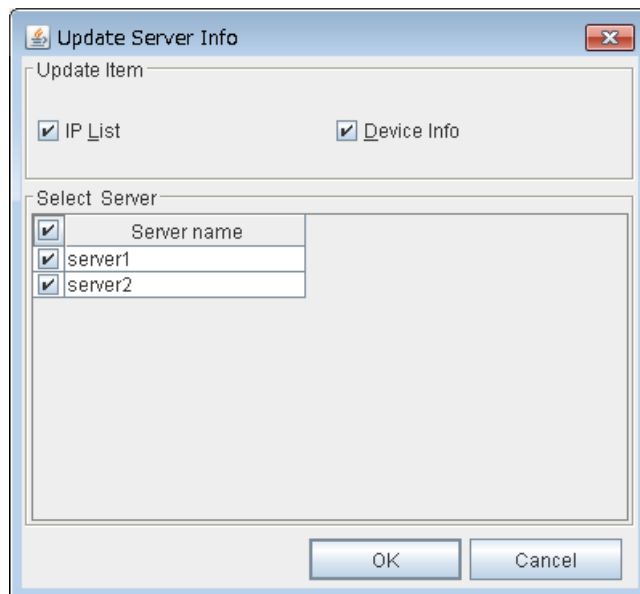

Update Item

- ◆ IP List
Get the IP address list.
- ◆ Device Info
Get the device information of disk.

Select Server

Specify the servers from which the information is obtained. By clicking the check box on the table title, the status of all the server check boxes can be changed at once.

Changing communication settings

Select **Option** and then the **Online** tab to change settings for server communication. This settings are not recognized in the offline version.

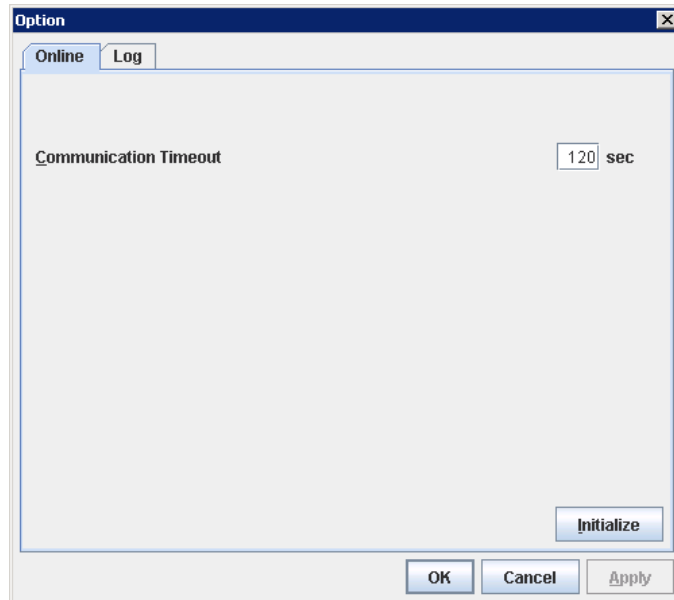

Communication Timeout (0 to 999)

This is the time-out value when accessing a server.

Changing log level settings of Builder

Select **Option** and then the **Log** tab to change the log level of the Builder.

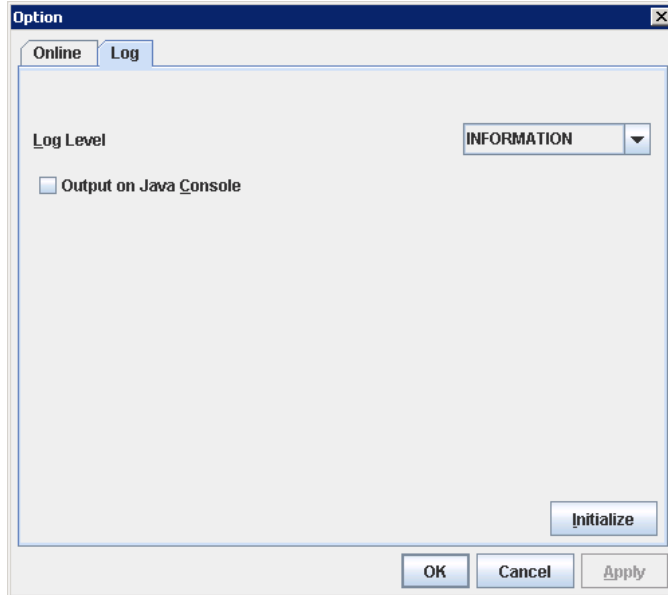

Log Level

Configure the level of internal logs that Builder produces during operating.

- **ERROR**
Select this to read only error-level logs .
- **WARNING**
Select this to read warning-level and error-level logs.
- **INFORMATION**
Select this to read information-level, warning-level, and error-level logs.
- **TRACE1,2,3**
Select this to read logs of internal trace, and those from the information, warning and error levels. The greater the number is, more detailed the trace is.

Output on Java Console

Click this to configure whether or not to report logs to the Java console.

Collecting Builder logs

Select **Save Log Files** to collect the Builder logs.

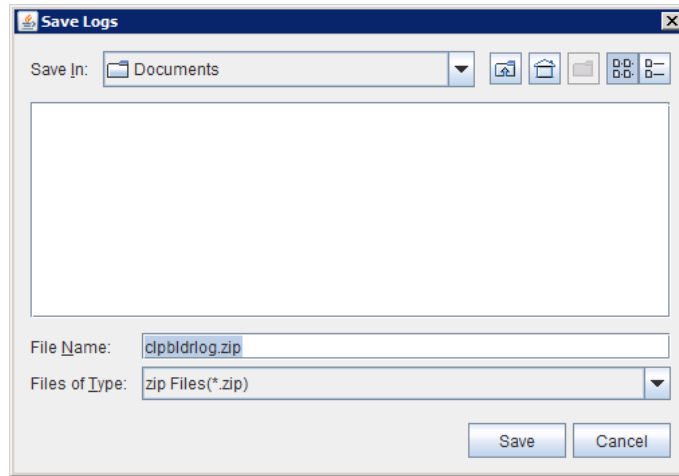

Specify the destination to store logs, and select **Save**.

Exiting from the Builder

Exit from the Builder by selecting **Exit**. Do not exit from your Web browser.

If any change was made in the cluster configuration data, a dialog box asks if you want to save the changes.

Select **Yes** to save the changes. The dialog box where you can specify a folder to save the file is displayed. For how to save the file, refer to "Saving the configuration file" on page 125. Select **No** if you do not need to save the changes. Exit from the Builder discarding the changes you made in the cluster configuration data.

View menu

Select **View** menu on the online version and the following pull down menu is displayed.

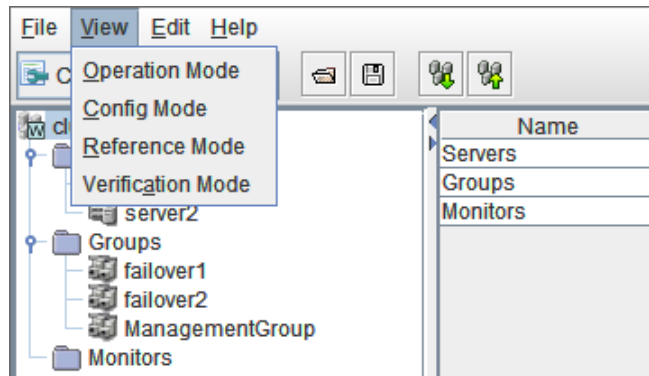

Operation Mode

Switches from the currently displayed mode to the WebManager operation mode.
This is the same as selecting **Operation Mode** from the drop-down menu on the toolbar.

Config Mode

Switches from the currently displayed mode to the Builder setup mode.
This is the same as selecting **Config Mode** from the drop-down menu on the toolbar.

Reference Mode

Switches from the currently displayed mode to the WebManager reference mode.
This is the same as selecting **Reference Mode** from the drop-down menu on the toolbar.

Verification Mode

Switches from the currently displayed mode to the WebManager verification mode.
This is the same as selecting **Verification Mode** from the drop-down menu on the toolbar.

Edit menu

To open the **Edit** menu: on the menu bar, click **Edit**.

Menu	Function
Add	Adds the object.
Remove	Deletes the selected object.
Rename	Changes the name of the selected object.
Properties	Displays the properties of the selected object.
Add Management Group	Adds the management group.

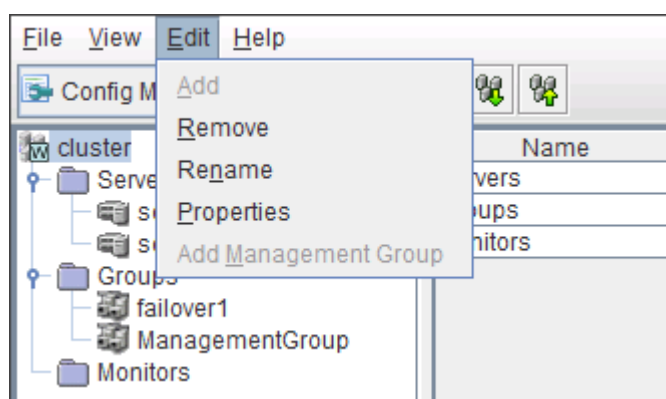

Adding an object

Displays the wizard for adding a server, group, group resource or monitor resource. For details, see Chapter 5, “Creating the cluster configuration data” in the *Installation and Configuration Guide*.

What you can add varies depending on what you select as shown below.

If select	Object to be added	How to change
Groups	Group	SuspendResume
group_name	Group resource	SuspendResume GroupStopRestart
Monitors	Monitor resource	SuspendResume
Servers	Server	SuspendResume

Note:



If **Auto Failback** is set to **Failback Attribute** in **Group Properties**, a mirror disk resource/hybrid disk resource cannot be added. Set **Failback Attribute** to **Manual Failback** and add a mirror disk resource and hybrid disk resource.

Removing an object

Displays a dialog box that asks if you want to remove the selected cluster, server, group, group resource, or monitor resource. Select **Yes** for removing and **No** for not removing it.

To remove a cluster, select **New File** from the **File** menu.

You cannot remove an object if any of the following conditions is met:

If select	Conditions	How to change
 Cluster Name	None	
 Server Name	<ul style="list-style-type: none"> - There is no other server. - The server is the only server where the group can start up. 	SuspendResume
 Group Name	<ul style="list-style-type: none"> - A recovery target of monitor resource⁴. - Has group resources. 	SuspendResume GroupStopRestart
Group Resource Name	<ul style="list-style-type: none"> - A recovery target of monitor resource⁴. - A target object in the monitoring timing of monitor resource⁴. - To be monitored by the mirror disk monitor resource¹. - A mirror disk resource that uses the mirror connect to be monitored by the mirror disk connect monitor resource⁴. - Other group resources in the same group depend on it. 	SuspendResume GroupStopRestart
Monitor Resource Name	<ul style="list-style-type: none"> - No condition for those other than mirror disk monitor resource. - Auto Mirror Recovery is selected on the Mirror Disk tab of Cluster Properties for mirror disk monitor resource. 	SuspendResume

⁴ A message asks if you want to delete the specified object's monitor resources. If you select **Yes**, the specified object's monitor resources will be deleted, and the object will be removed.

Renaming an object

Displays a dialog box for renaming the selected cluster, server, group, group resource, or monitor resource.

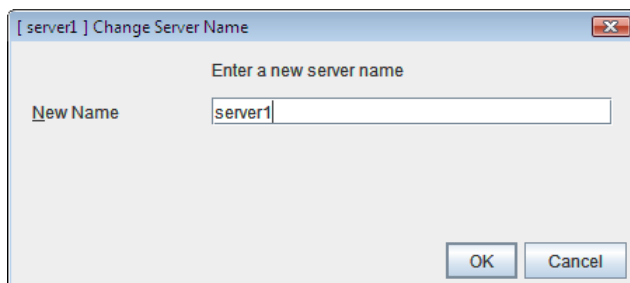

The following are restrictions for each of the objects.

If select	Naming rules	How to change
Group Name	- Only alphanumeric characters, hyphen (-), underscore (_) and space are allowed for names.	SuspendResume GroupStopRestan
Group Resource Name	- Up to 63 characters (63 bytes) - Names cannot start or end with a hyphen (-) or space.	SuspendResume GroupStopRestan
Cluster Name Monitor Resource Name		SuspendResume
Server Name	- There are naming rules that are the same as the host name of TCP/IP that can be set by the OS. It should be completely the same as the name set to the server. - Up to 63 characters (63 bytes) - Neither hyphen (-) nor space can be the first or last letter in names. - Underscore (_) is not allowed. - A name consisting of only numbers is not allowed. - Do not use "localhost" as the server name.	When changing a server name, you have to be careful. For the server name renaming procedure, see Chapter 10, "The system maintenance information" in this guide.

Names should be unique (case-insensitive) by categories such as cluster, server, group, group resource and monitor resource.

Properties

Displays properties of a selected cluster, servers, server, group, group resource, or monitor resource.

For details, see "Parameter details" on page 137.

Help Menu

Checking the version information of the Builder

To check the version information of the Builder, click **Help** in the menu bar, and then select **Version Information**.

Parameter details

Cluster properties

In **Cluster Properties**, you can view and change the cluster's settings.

Info tab

You can view the cluster name, and enter or change a comment for this cluster.

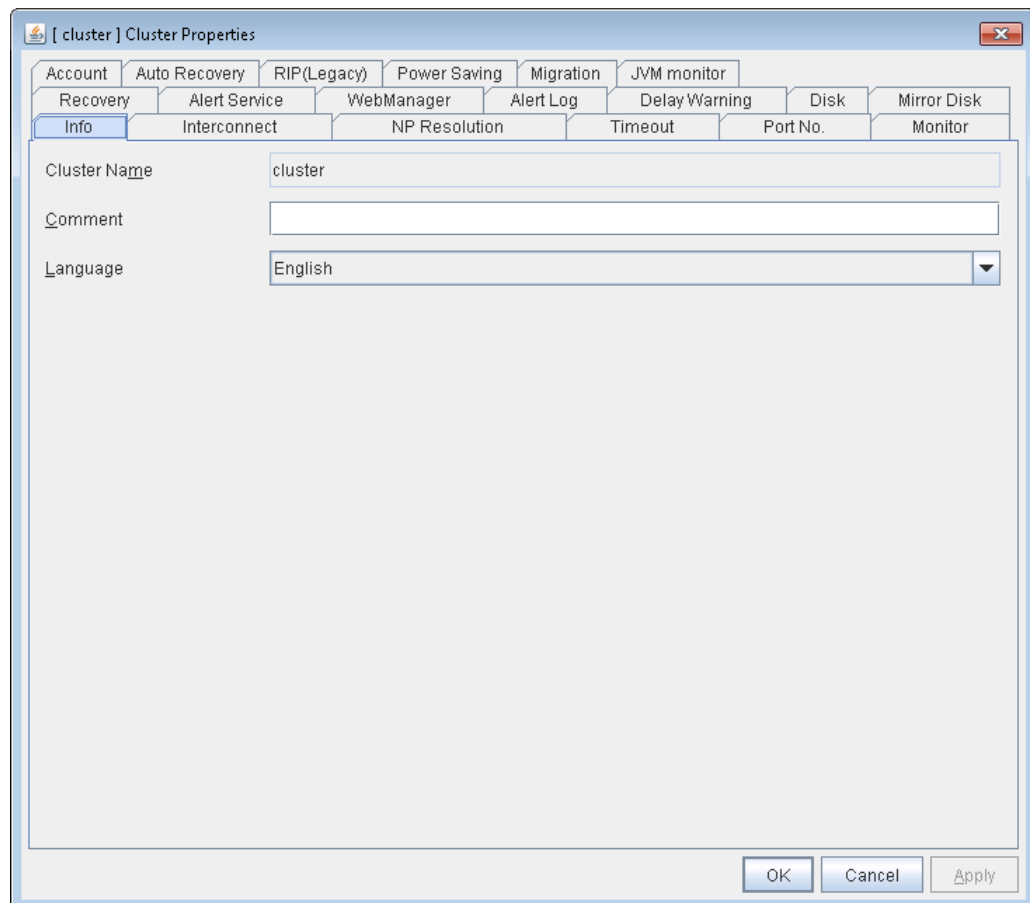

Cluster Name **SuspendResume**

The cluster name is displayed. You cannot change the name here.

Comment

You can enter a comment for the cluster. Only alphanumeric characters are allowed.

Language **SuspendResume** **MStopRestart**

Select a language for cluster from the following. Set the language (locale) of OS on which the WebManager runs.

- ◆ English
- ◆ Japanese
- ◆ Chinese

Interconnect tab

This tab allows you to set up network communication paths between cluster servers.

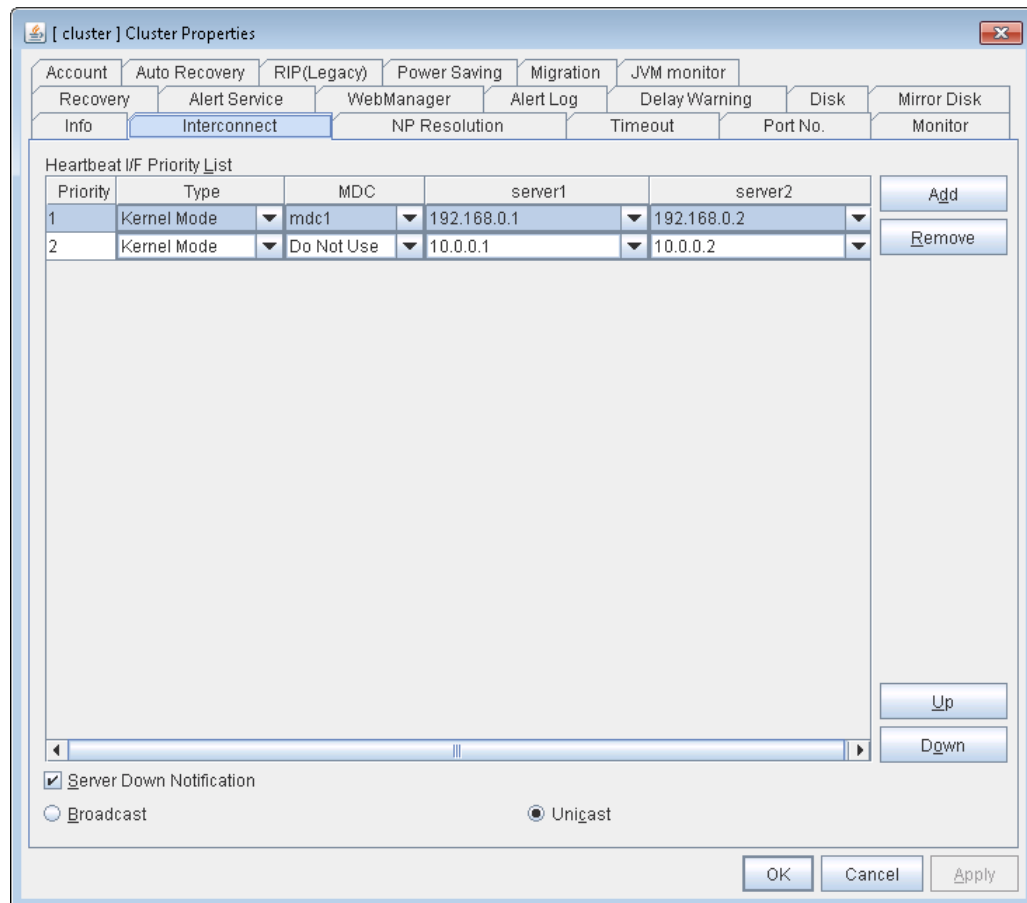

The **Heartbeat I/F Priority List** displays network communication paths between servers in the cluster.

Add **SuspendResume**

Adds a communication path. To specify the IP address of the communication path for each server, click a cell in each server's column, and then select or enter the address. For a communication route to which some servers are not connected, leave the cells for the unconnected servers blank.

Remove **SuspendResume**

Removes a communication path. Select the column of the communication path to remove, and then click **Remove** to remove the selected path.

Type **SuspendResume** **ShutdownReboot**

For a communication route used for kernel mode LAN heartbeat transmission (interconnect), click a cell in the **Type** column, and then select **Kernel Mode**.

Specify as many communication routes for the interconnect as possible.

To use a BMC heartbeat resource, select **BMC**.

To prepare a dedicated data mirroring communication path (mirror disk connect), click the **Type** column cell and then select **Mirror Communication Only**.

MDC column **ShutdownReboot**

To use a communication path as a mirror disk connect, click the **MDC** column cell and then select a mirror disk connect.

The entry differs depending on the type.

◆ **Kernel Mode or Mirror Communication Only**

Select a mirror disk connect from the combo box.

When a mirror disk connect is not used, select **Do Not Use**.

◆ **BMC**

No mirror disk connect is available.

Do Not Use is automatically entered in the **MDC** column cell and the cell cannot be edited.

Up & Down **SuspendResume**

When multiple IP addresses for Integrated WebManager are configured, the communication path with the smallest number in the Priority column is used preferentially for the internal communication among cluster servers. To change the priority, change the order of selected rows with **Up** or **Down**. It is recommended to specify a higher priority for the interconnect communication path than any other paths.

Note:

Priority is used to decide on the priority of communication routes used for internal communication between the servers in the cluster. Heartbeat between the servers in the cluster is implemented on all communication routes that are set up for heartbeat, regardless of Priority.

Server column **SuspendResume** **ShutdownReboot**

The entry differs depending on the type.

◆ **Kernel Mode or Mirror Communication Only**

Enter IP address. Leave the cells for any unused paths blank.

◆ **BMC**

Enter the BMC IP address. When the BMC is not used, leave the cell blank.

Note:

- More than one IP addresses which belong to the same network address cannot exist in a single server. And also, inclusive relation cannot exist like the following relation.
 IP address:10.1.1.10, subnet mask:255.255.0.0
 IP address:10.1.2.10, subnet mask:255.255.255.0
- To list the IP addresses to be set for the interconnect in the list box on the online version Builder, execute **Update Server Info** from the **File** menu.

Server Down Notification

When a server stops successfully (including shutdown and reboot), it is notified to other servers in the cluster. You can perform failover faster by notifying it in advance.

When failing to deactivate groups when a server stops (including shutdown and reboot), or when other abnormalities occur, other servers are not notified of it regardless of the settings of failed server notification.

- ◆ When the check box is selected
 Server down will be notified.

- ◆ When the check box is not selected
Server down will not be notified.

Broadcast and Unicast `SuspendResume`

Select the communication method of a kernel mode LAN heartbeat from the following.

- ◆ Broadcast
Communicate in broad cast method. However, it cannot be used with IP v6.
- ◆ Unicast
Communicate in unicast method

NP Resolution tab

Set up the network partition (NP) resolution method.

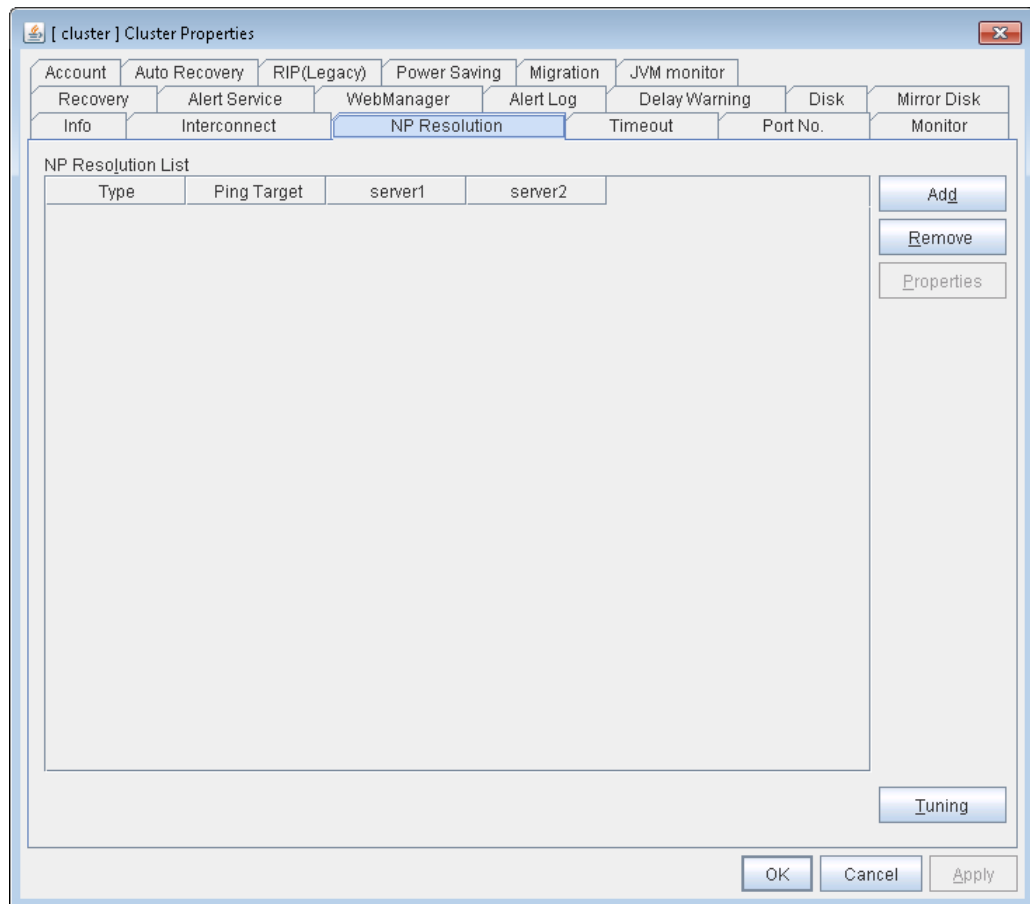

Add

Add network partition resolution (NP resolution) resource. Click the **Type** column cell and select the type of NP resolution type (**COM**, **DISK**, **Ping**, **Majority**). If the type is **Ping**, click the Ping target column cell and set the IP address of the Ping destination device. Click the cell of each server and set **Use** or **Do Not Use**.

Remove

Remove network partition resolution resource. Select the network partition resolution resource to be removed and click **Remove**, then the selected network partition resolution resource is removed.

Properties

Only available when the selected resource type is **DISK** or **Ping**. The **DISK NP Properties** or **Ping NP Properties** window is displayed.

Tuning

Network Partition Resolution Tuning Properties window is displayed.

Type

Set the type of network partition resolution resource. **COM, DISK, Ping, Majority** is selectable.

Ping Target

Set the IP address of the Ping destination device with Ping method NP resolution. Available only when the type is **Ping**.

Server

Entry differs depending on the type.

◆ **COM**

Enter the COM port used on communication.

◆ **DISK**

Enter the drive letter for disk heartbeat partition.

Note:

To list the drive letters to be set for the disk heartbeat partition in the list box on the online version Builder, execute **Update Server Info** from the **File** menu.

◆ **Ping, Majority**

Select either **Use** or **Do Not Use**.

DISK NP Properties

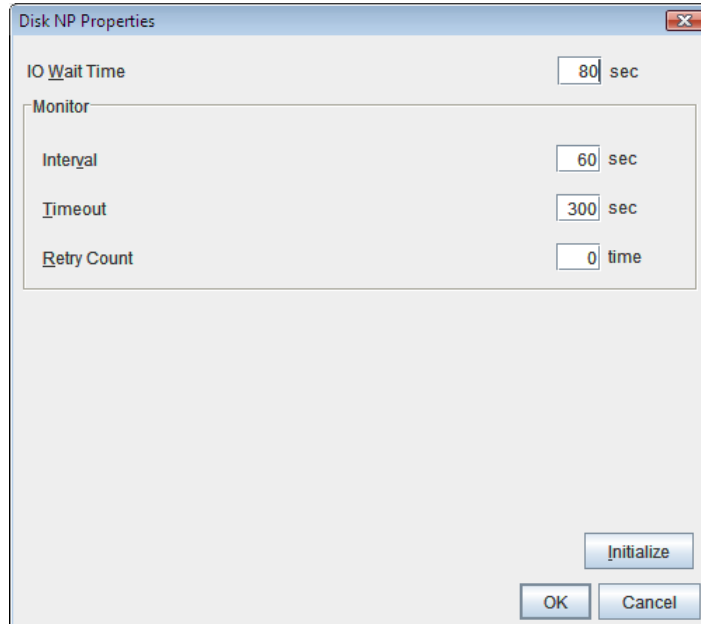

◆ **IO Wait Time**

Set the disk I/O wait time. Set the value so that the value exceeds the maximum delay time of the disk I/O of the shared disk device. When the disk path is duplicated, I/O delay caused by switching path needs to be considered.

◆ **Interval**

Set the disk heartbeat interval.

- ◆ **Timeout**
Set the disk heartbeat timeout.
- ◆ **Retry Count**
Set the retry count.
- ◆ **Initialize**
Set the I/O wait time, interval, timeout and retry count to the default values.

Ping NP Properties

The screenshot shows the 'Ping NP Properties' dialog box. It is divided into three sections:

- Interface:** A table with columns 'No' and 'IP Address'. It contains one entry: No. 1, IP Address 192.168.0.254. To the right are 'Add' and 'Remove' buttons.
- IP Address:** A list with one entry: 192.168.0.254. To the right are 'Add', 'Remove', and 'Edit' buttons.
- Detailed Settings:** Three input fields: 'Interval' (5 sec), 'Timeout' (3 sec), and 'Retry Count' (3 time). Below them is an 'Initialize' button.

At the bottom of the dialog are 'OK' and 'Cancel' buttons.

- ◆ **Add Group List**
Add IP address group of Ping target.
The maximum number of registered group is 16.
If multiple IP addresses are registered in one group, and if the state in which no response to the ping command is returned from all the IP addresses is maintained, NP resolution processing cannot be performed (if there is even one IP address responding to the ping command, NP resolution processing can be performed). Also, if multiple groups are registered, and if the state in which no response to the ping command is returned from any one group is maintained, NP resolution processing cannot be performed (if all groups respond to the ping command, NP resolution processing can be done).
- ◆ **Remove Group List**
Remove the selected group.
- ◆ **Add IP Address List**
Add IP address to the selected group.
The maximum number of registered IP address is 16.
Maximum 256 IP addresses are able to be registered to a single Ping NP resource, and 16 kinds of IP addresses can be registered. (The same IP addresses can be used.)

- ◆ **Remove IP Address List**
Remove the selected IP address from the list.
- ◆ **Edit**
Edit the selected IP address.
- ◆ **Interval**
Set the Ping interval
- ◆ **Timeout**
Set the timeout of Ping response wait.
- ◆ **Retry Count**
Set the retry count.
- ◆ **Initialize**
Set the interval, timeout and retry count to the default values. Note that, when an interval and retry count are specified, the following conditional expression must be satisfied. If not satisfied, NP resolution processing cannot be performed normally.

Conditional expression) Heartbeat timeout > (interval × retry count)

Network Partition Resolution Tuning Properties

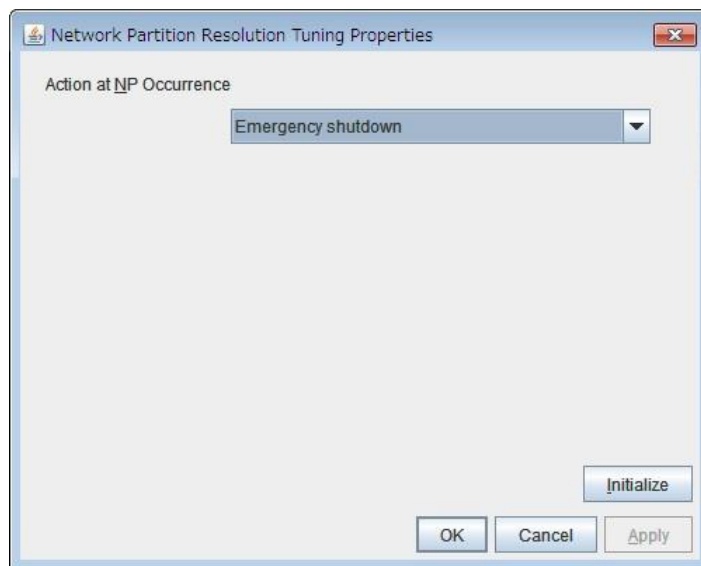

- ◆ **Action at NP Occurrence**
 - ◆ **Stop the cluster service**
Stop the EXPRESSCLUSTER Server service of the server in network partition.
 - ◆ **Stop the cluster service and shutdown OS**
Stop the EXPRESSCLUSTER Server service of the server in network partition, and then shuts down the OS.
 - ◆ **Stop the cluster service and reboot OS**
Stop the EXPRESSCLUSTER Server service of the server in network partition, and then reboots the OS.
 - ◆ **Emergency shutdown**
Shutdown the server in network partition.
 - ◆ **Generating an intentional Stop Error**
Intentionally cause stop error for the server in network partition.

- ◆ **Reset the hardware⁵**
Restart the server by HW reset in network partition.

Note:

When mirror disk resources or hybrid disk resources are used, it is not recommended that you set **Stop the cluster service** for **Action at NP Occurrence**. If **Stop the cluster service** is set, you might have to run the forcible mirror recovery at the time of recovery from NP occurrence.

- ◆ **Initialize**
 - ◆ Set the actions at NP occurrence to the default settings.

⁵ This function does not require ipmiutil, unlike the forced stop function.
Section I Detailed functions of EXPRESSCLUSTER

Timeout tab

Specify values such as time-out on this tab.

The screenshot shows the 'Cluster Properties' dialog box with the 'Timeout' tab selected. The dialog contains several configuration fields:

- Network initialization complete wait time:** 3 min
- Server Sync Wait Time:** 5 min
- Heartbeat:**
 - Interval: 3 sec
 - Timeout: 30 sec
- Server Internal Timeout:** 180 sec

At the bottom right, there is an 'Initialize' button. At the bottom center, there are 'OK', 'Cancel', and 'Apply' buttons.

Network initialization complete wait time (0 to 99)

This is the time the server waits until its NIC becomes valid after startup.

Server Sync Wait Time (0 to 99)

For the time specified here, the server will wait at startup until other servers are started.

Heartbeat

◆ Interval (1 to 99) **SuspendResume**

Interval of heartbeats

◆ Timeout (2 to 9999) **SuspendResume**

A server is determined to be failed if there is no response for the time specified here.

- This time-out should be longer than the interval.

Server Internal Timeout (1 to 9999) **SuspendResume**

The timeout to be used in the EXPRESSCLUSTER Server internal communications that are performed while an EXPRESSCLUSTER command is executed, or an operation is performed or a screen is displayed by WebManager.

Initialize

Used for initializing the value to the default value. Click **Initialize** to initialize all the items to their default values.

Port No. tab

Specify TCP port numbers and UDP port numbers.

The screenshot shows the 'Port No.' tab in the 'Cluster Properties' dialog box. The dialog has several tabs: Account, Auto Recovery, RIP(Legacy), Power Saving, Migration, JVM monitor, Recovery, Alert Service, WebManager, Alert Log, Delay Warning, Disk, Mirror Disk, Info, Interconnect, NP Resolution, Timeout, Port No., and Monitor. The 'Port No.' tab is selected and shows the following port configurations:

Service	Port Number
Server Internal Port Number	29001
Data Transfer Port Number	29002
WebManager HTTP Port Number	29003
Disk Agent Port Number	29004
Mirrgr Driver Port Number	29005
Kernel Mode Heartbeat Port Number	29106
Alert Sync Port Number	29003
Client Service Port Number	29007

Buttons at the bottom include 'Initialize', 'OK', 'Cancel', and 'Apply'.

TCP

No TCP port numbers can be overlapped. When the Replicator/Replicator DR is used, they should not be overlapped with any mirror data port number of any mirror disk resources and hybrid disk resource.

- ◆ **Server Internal Port Number** (1 to 65535⁶) **SuspendResume** **MStopRestart**
This port number is used for internal communication.
- ◆ **Data Transfer Port Number** (1 to 65535⁶) **ShutdownReboot**
This port number is used for transactions such as applying and backing up the cluster configuration data, sending and receiving the license data and running commands.
- ◆ **WebManager HTTP Port Number** (1 to 65535⁶) **MStopRestart**
This port number is used for a browser to communicate with the EXPRESSCLUSTER Server.
- ◆ **Disk Agent Port Number** (1 to 65535⁶) **ShutdownReboot**
This port number is used for a disk agent port number.
- ◆ **Mirror Driver Port Number** (1 to 65535⁶) **ShutdownReboot**
This port number is used for a mirror driver.

⁶ It is strongly recommended not to use well-known ports, especially reserved ports from 1 to 1023.
Section I Detailed functions of EXPRESSCLUSTER

UDP

No UDP port numbers can be overlapped.

- ◆ **Kernel Mode Heartbeat Port Number** (1 to 65535⁶) **SuspendResume**
This port number is used for kernel mode heartbeat.
- ◆ **Alert Sync Port Number** (1 to 65535⁶) **MStopRestart**
This port number is used for synchronizing alert messages among servers.

TCP/UDP

- ◆ **Client Service Port Number** (1 to 65535⁶) **ShutdownReboot**
This port number is used for client service.

Initialize

This is used for initializing the value to the default value. Click **Initialize** to initialize all the items to the default values.

Monitor tab

Specify the settings for monitoring.

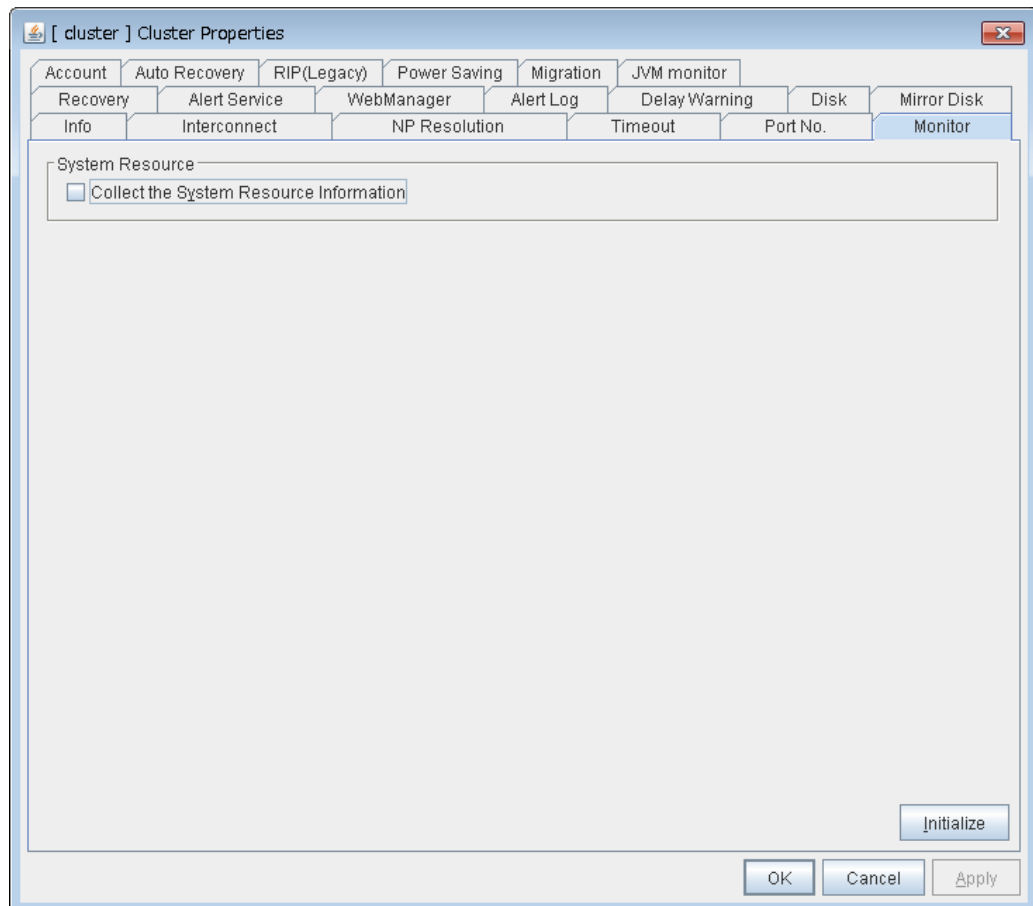

System Resource

Select whether to collect system resource information.

System resource information is collected regularly so as to improve system operability. System resource information is useful for investigating the operation status of EXPRESSCLUSTER, and makes it easy to determine the cause of a failure attributable to a shortage of system resources.

- When the check box is selected

System resource information related to the CPU, memory, processes, and others is collected regularly while the cluster is running.

The collected system resource information is collected when the `clplogcc` command or WebManager collects logs.

Specify type 1 to collect the log by the `clplogcc` command; specify Pattern 1 to collect the log by the WebManager. For details on log collection, see “Collecting logs (clplogcc command)” in Chapter 3, “EXPRESSCLUSTER command reference” and “Collecting logs by using the WebManager” in Chapter 1, “Functions of the WebManager” in this guide.

A disk area of 450 MB or more is required to store the resource information, depending on the system operating conditions such as the number of processes that are running.

- When the check box is not selected

No system resource information is collected.

Recovery tab

Make settings on cluster recovery.

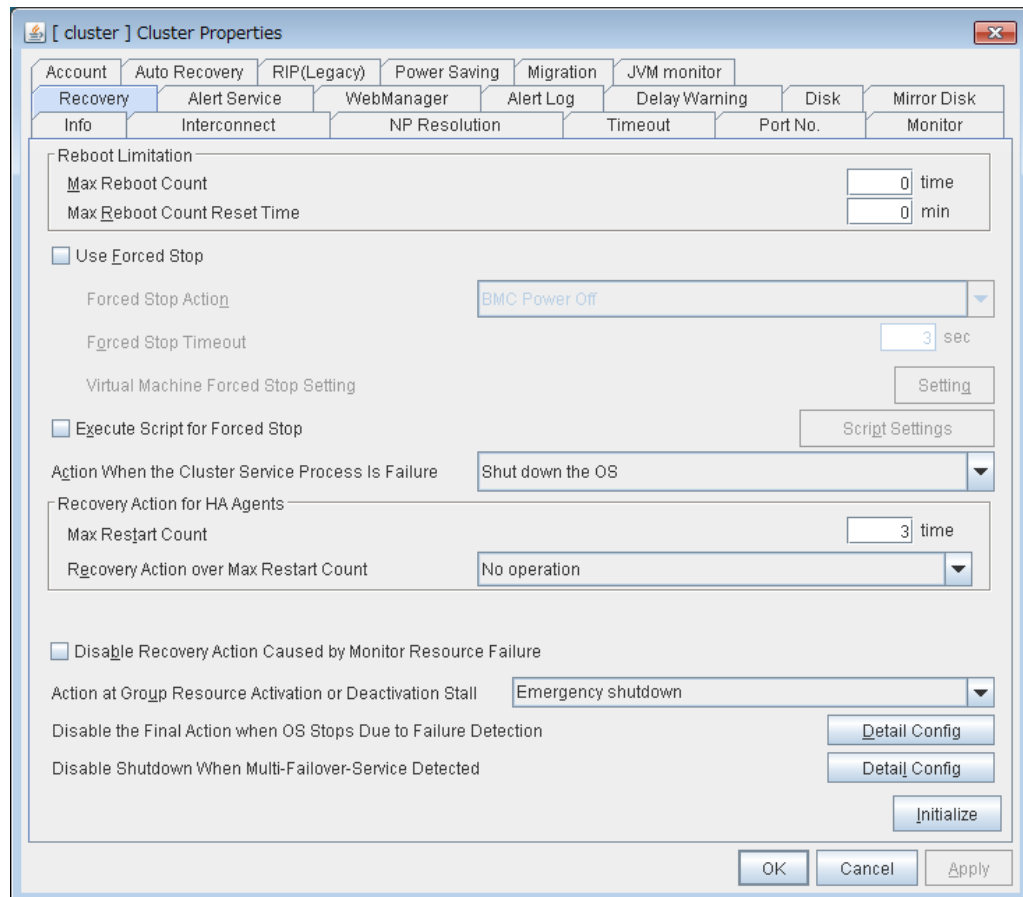

Reboot Limitation

You can specify the **Reboot OS** or **Shut down OS** as the final action at abnormality detection for group resources and monitor resources. If either of them is selected, reboot may be repeated infinitely. By setting the reboot limit, you can prevent repeated reboots.

- ◆ **Max Reboot Count** (0 to 99) **SuspendResume**

Specify how many times the operating system can reboot. The number specified here is separately counted for group resource and monitor resource.

- ◆ **Max Reboot Count Reset Time** (0 to 999) **SuspendResume**

When the max reboot count is specified, if the operation from the cluster startup keeps running normally for the time specified here, the reboot count is reset. The time specified here is separately counted for group resource and monitor resource.

Note:

If **Max Reboot Count** is set to 1 or greater, usually set **Max Reboot Count Reset Time** to 1 or greater (default: 0). If **Max Reboot Count Reset Time** is set to zero (0), the reboot count is not reset. To reset the reboot count, use the `clpregctrl` command.

Use Forced Stop

Use this to select whether or not to enable the forced stop.

- On

If selected, the forced stop function is enabled.

For a physical machine, configure the settings on the **BMC** tab of the server properties. For a virtual machine (guest OS), configure the **Virtual Machine** setting on the **Info** tab of the server properties.

- Off

If selected, the forced stop function is disabled.

Forced Stop Action

Specify an action of the forced stop.

- BMC Reset

Conditional expression) Heartbeat timeout > (interval × retry count)

- BMC Power off

Use this to power off the server by using the `hwreset` or `ireset` command. The OS may be shut down depending on how the **Power Options** of OS is configured. For details, see “Forced stop function Notes on forced stop” in Chapter 9, “Other monitor settings” in this guide.

- BMC Power Cycle

Use this to perform the Power Cycle (powering on/off) by using the `hwreset` or `ireset` command. The OS may be shut down depending on how the ACPI of OS is configured. For details, see “Forced stop function Notes on forced stop” in Chapter 9, “Other monitor settings” in this guide.

- BMC NMI

Use this to generate NMI by using the `hwreset` or `ireset` command. The behavior after NMI is generated depends on the OS settings..

Forced Stop Timeout (0 to 999)

Configure the timeout value when performing Forced Stop. When one of the above commands is executed, activation of the failover group starts after the time specified elapses.

Conditional expression) Heartbeat timeout > (interval × retry count)

Virtual Machine Forced Stop Setting

Configure forced stop for the virtual machine (guest OS). Click **Setting** to display the **Virtual Machine Forced Stop Setting** dialog box.

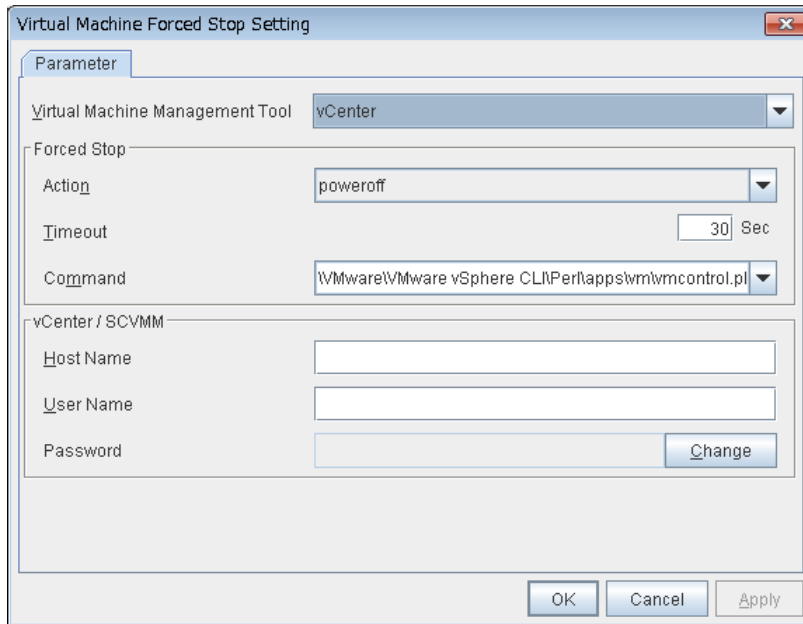

Virtual Machine Management Tool

- ◆ vCenter
Specify this option when using vCenter for virtual machine control.
- ◆ SCVMM
Specify this option when using SCVMM for virtual machine control.

Forced Stop

- ◆ Action
Specify the action performed upon a forced stop.
 - Power Off
Use this to power off the server by using the command specified in **Command**.
- ◆ Timeout (0 to 99)
Set the timeout value to be used when performing a forced stop. After the above command is executed, the activation of failover groups starts when the time specified here elapses.
- ◆ Command (Within 1023 bytes)
Specify the command for forced stop.

vCenter / SCVMM

- ◆ Host name (Within 45 bytes)
Specify the host name of the virtual machine management tool.
- ◆ User Name (Within 255 bytes)
Specify the user name of the virtual machine management tool.
- ◆ Password
Specify the password for the virtual machine management tool.

Note: Do not use a double quotation mark (") in the password.

Execute Script for Forced Stop

Use this to select whether or not to execute a script for the forced stop.

- **On**
If selected, the script is executed for the forced stop.
- **Off**
If selected, the script is not executed.

Script Setting

Make settings on the script for the forced stop. Click **Script Setting** play the **Edit Script** dialog box.

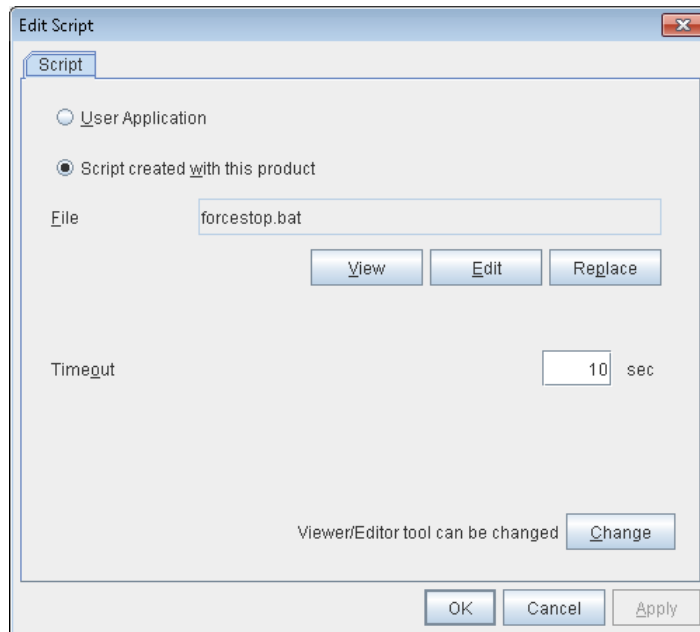

User Application

Use an executable file (executable batch file or execution file) on the server as a script. For the file name, specify an absolute path or name of the executable file of the local disk on the server. If you specify only the name of the executable file, you must configure the path with environment variable in advance. If there is any blank in the absolute path or the file name, put them in double quotation marks (“”) as follows.

Example:

“C:\Program Files\script.bat”

If you want to execute VBScript, enter a command and VBScript file name as follows.

Example:

cscript script.vbs

Each executable file is not included in the cluster configuration information of the Builder. They must be prepared on each server because they cannot be edited or uploaded by the Builder.

Script created with this product

Use a script file which is prepared by the Builder as a script. You can edit the script file with the Builder if you need. The script file is included in the cluster configuration information.

File (Within 1023 bytes)

Specify a script to be executed (executable batch file or execution file) when you select **User Application**.

View

Click here to display the script file with the editor when you select **Script created with this product**. The information edited and stored with the editor is not applied. You cannot display the script file if it is currently displayed or edited.

Edit

Click here to edit the script file with the editor when you select **Script created with this product**. Overwrite the script file to apply the change. You cannot edit the script file if it is currently displayed or edited. You cannot modify the name of the script file.

Replace

Click here to replace the contents of a script file with the contents of the script file which you selected in the file selection dialog box when you select **Script created with this product**. You cannot replace the script file if it is currently displayed or edited. Select a script file only. Do not select binary files (applications), and so on.

Timeout (1 to 999)

Specify the maximum time to wait for completion of script to be executed. The default value is set as 10.

Change

Click here to display the **Change Script Editor** dialog. You can change editor for displaying or editing a script to an arbitrary editor.

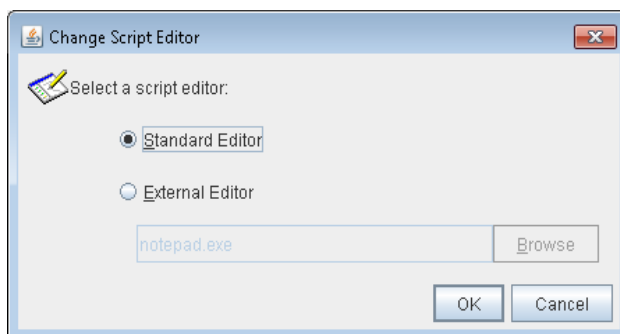

Standard Editor

Select here to use a standard editor (Notepad (notepad.exe)) as a script editor.

External Editor

Select here to specify an arbitrary script editor. Click **Browse** to specify the editor to be used.

◆ Action When the Cluster Service Process Is Abnormal

Specify an action at process abnormality of the cluster service.

- Shut down the OS
Shut down the OS.
- Generate an intentional stop error
Generate a stop error (Panic) intentionally and restart the server.
- Reset the hardware⁷
Restart the server by HW reset.

The following two cluster service processes are monitored by this function:

- clprc.exe
- clpnm.exe

Recovery Action for HA Agents

- ◆ Max Restart Count (0 to 99) **SuspendResume**
Specify the max restart count when an HA Agent error has occurred.
- ◆ Recovery Action over Max Restart Count
Specify the action when an HA Agent error has occurred.
 - No operation
 - Stop cluster service **SuspendResume**
Stops the cluster service of the server that detected an error.
 - Stop cluster service and shutdown OS
Stops the cluster service of the server that detected an error, and then shuts down the OS.
 - Stop cluster service and reboot OS
Stops the cluster service of the server that detected an error, and then reboots the OS.

Note:

The HA process is used with the system monitor resource, JVM monitor resource, and system resource information collection function.

Disable Recovery Action Caused by Monitor Resource Error

- When the check box is selected
The recovery action is disabled when the monitor resource is error.
- When the check box is not selected
The recovery action is enabled when the monitor resource is error.

Note: This recovery action suppression function is intended to suppress the recovery action due to the error detection of a monitor resource. This does not suppress the recovery action at the time of an activation error of a group resource.

This function is not enabled for the action at the time of the stall error detection of the disk RW monitor resource or at the time of a timeout of the user space monitor resource.

⁷ This function does not require ipmiutil, unlike the forced stop function.
Section I Detailed functions of EXPRESSCLUSTER

This option is not available for the message receive monitor resource.

Action to apply in the event of an activation/deactivation stall of a group resource

Specify the action to apply in the event of an activation/deactivation stall of a group resource.

- **Emergency shutdown**
Shutdown the server on which a stall occurred.
- **Intentionally causing a stop error**
Intentionally cause a stop error (Panic) on the server on which a stall occurred.
- **Nothing (handle a stall as an activation/deactivation failure)**
Use this to perform recovery upon the detection of an activation/deactivation failure of a group resource. For details on the recovery operation, see “Displaying and changing the operation settings when a group resource error is detected (Common to group resources)” in “Displaying and changing the settings of group resources” in Chapter 5, “Group resource details” in this guide.

Note:

If a stall occurs with “Nothing (handle a stall as an activation/deactivation failure)” specified, the effect on the group resources is undefined, so we do not recommend changing the setting to “Nothing (handle a stall as an activation/deactivation failure)”. If you do specify “Nothing (handle a stall as an activation/deactivation failure)”, set the recovery operation upon the detection of an activation/deactivation failure of a group resource as described below.

- Activation/deactivation retry threshold: 0 (times)
- Failover threshold: 0 (times)
- Final action: Intentionally causing a stop error

If **Stop the cluster service and shut down OS** or **Stop the cluster service and reboot OS** is specified as the final action, it takes a considerable amount of time for the cluster service to stop.

Disable the Final Action when OS Stops Due to Failure Detection

Click **Detail Config** to set suppression of the final action which accompanies the OS stop caused by error detection.

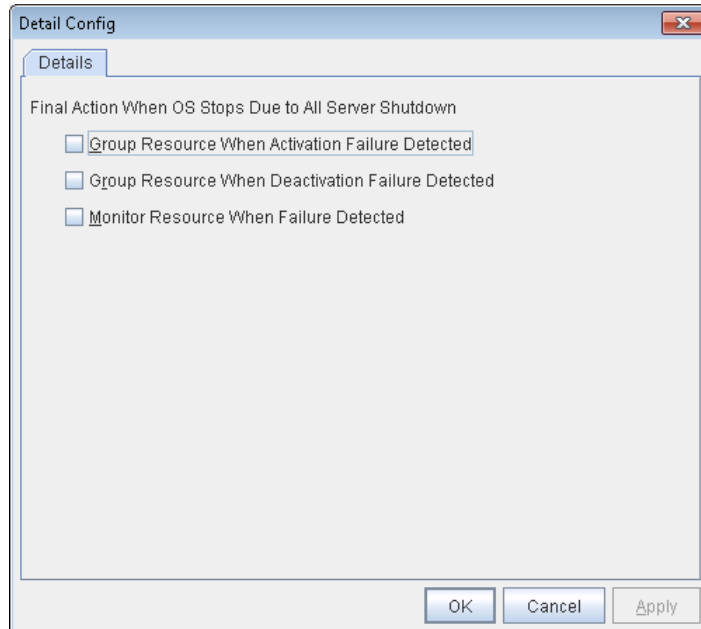

- **Group Resource When Activation Failure Detected**

If the final action caused by an activation error detection in a group resource accompanies the OS stop, the final action is suppressed if all other servers are stopped.

- **Group Resource When Deactivation Failure Detected**

If the final action caused by a deactivation error detection in a group resource accompanies the OS stop, the final action is suppressed if all other servers are stopped.

- **Monitor Resource When Failure Detected**

If the final action caused by an error detection in a monitor resource accompanies the OS stop, the final action is suppressed if all other servers are stopped.

Note:

- If errors were detected on multiple servers almost at the same time, and the final action was taken for those servers, the final action which accompanies the OS stop may be taken for all the servers even if the final action caused by an error detection in a monitor resource is set to be suppressed.
 - The message receive monitor resource does not become the target for which the final action caused by error detection is suppressed.
 - The following situations lead to an OS stop during the final action when an activation/deactivation error is detected in a group resource and during the final action when a monitor resource error is detected.
 - Cluster service stop and OS shutdown
 - Cluster service stop and OS restart
 - Generation of an intentional stop error
-

Disable Shutdown When Multi-Failover Detected

Click **Detail Config** to suppress the shutdown of all servers upon detection of both-system activation.

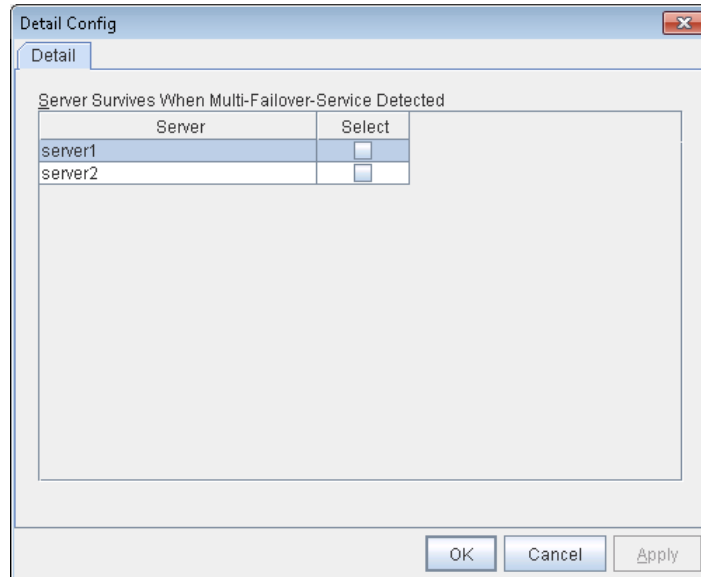

Select one server. The shutdown of the server, selected when the both-system activation of the failover group was detected, is suppressed.

Important:

Suppose that shutdown is suppressed upon the detection of both-system activation in an environment in which the mirror disk resource is used for setting automatic mirror recovery. In this case, automatic mirror copying starts when the server which is shut down upon the detection of both-system activation is re-started through the OS. Care is needed since this discards one piece of data from among that updated separately on the mirror disk of each server at both-system activation.

You need to select a server for which the data is to be protected when suppressing shutdown caused by the detection of both-system activation in an environment in which the mirror disk resource is used.

Note:

When the both-system activation is detected, the group statuses will be inconsistent among the servers, and failover and failback operations will be able to fail.

If a group status mismatch occurs, the following alert log is output. Restart, execute cluster reboot, or restart all of the servers on which the groups are not started, in order to fix this problem.

Type: Warning

Module name: rc

Event ID: 1104

Message: A mismatch in the group %1 status occurs between the servers.

Alert Service tab

Set up the alert service, chassis ID, and network warning light.

Note:

To use the mail alert function and network warning light, EXPRESSCLUSTER X Alert Service 3.3 for Windows is required.

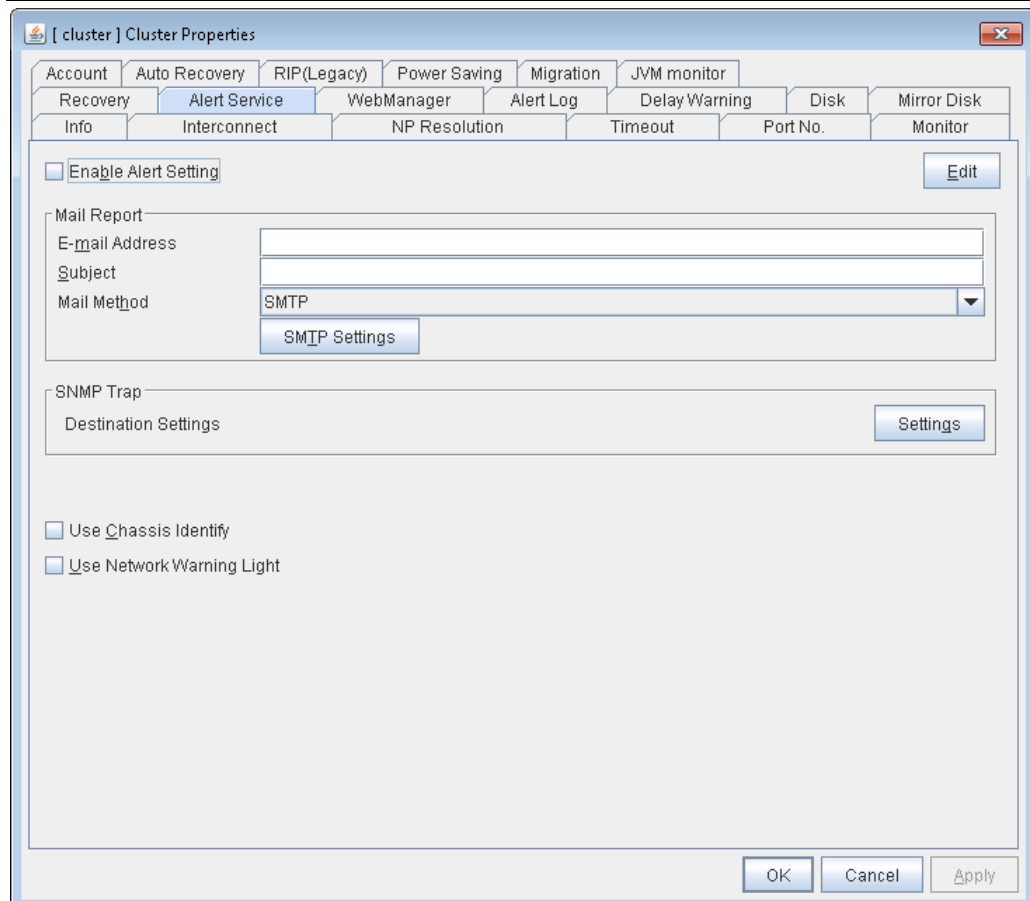

Enable Alert Setting

Configure whether to modify the alert destination from the default value. If you modify the alert destination, click **Edit** to set the destination address.

If you clear the check box, the destination address you have modified returns to the default settings temporarily.

For the default settings for the destination address, see “Messages reported by event log and alert” in Chapter 12, “Error messages” in this guide.

E-mail Address (Within 255 bytes)

Enter the e-mail address to which the report is sent. If more than two e-mail addresses are set, delimit the address by semicolon.

Subject (Within 127 bytes)

Enter the subject title for the e-mail message.

Mail Method

Configure the methods to send mail. In this version, SMTP is the only option in this.

- ◆ SMTP
Sends a mail by communicating directly with the SMTP server.

Destination Settings

Configure the SNMP trap transmission function. Click **Setting** to configure the SNMP trap transmission destination.

Use Chassis Identify **ShutdownReboot**

Configure whether or not to use the chassis identify function.

Use Network Warning Light **SuspendResume**

Configure whether or not to use the warning light (dedicated product) controlled by network. The IP address of warning light is entered on the server property.

Change Alert Destination

Clicking **Edit** displays the **Change Alert Destination** dialog box.

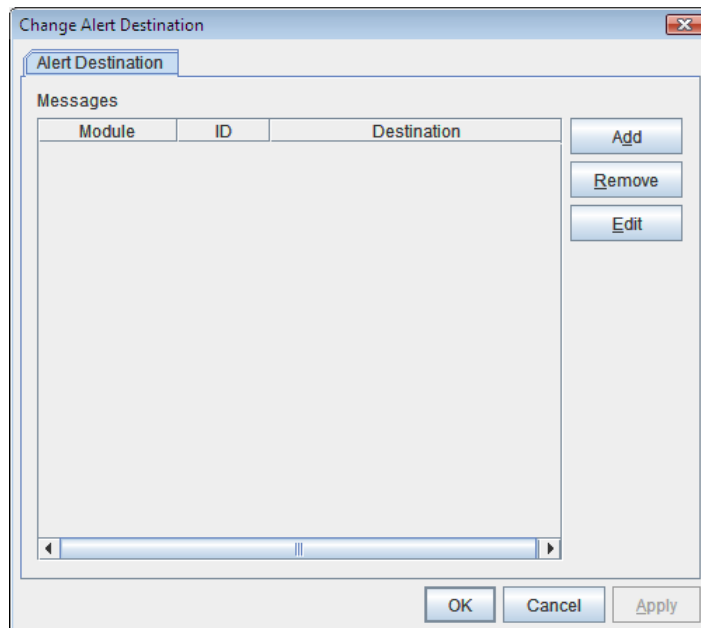

Add

Add the alert ID of the destination which you want to customize. Clicking **Add** displays the **Enter the message** dialog box.

The screenshot shows a dialog box titled "Enter the message". It has a "Message" tab. The "Category" dropdown is set to "Process". The "Module Type" dropdown is set to "apisv". The "Event ID" field is empty. The "Destination" section contains a table with the following rows:

Send	Destination
<input type="checkbox"/>	WebManager AlertLog
<input type="checkbox"/>	Alert Extension
<input type="checkbox"/>	Mail Report
<input type="checkbox"/>	SNMP Trap
<input type="checkbox"/>	EventLog(DisableOnly)

Below the table is a "Command" section with a text area and three buttons: "Add", "Remove", and "Edit". At the bottom of the dialog are "OK" and "Cancel" buttons.

Category

Select a major category of the module type.

Module Type (Within 31 bytes)

Select the name of module type that you want to change the destination address.

Event ID

Enter the message ID of the module type for which you want to change the destination. For information on the message IDs, see “Messages reported by event log and alert ” in Chapter 12, “Error messages” in this guide.

Destination

Select a message destination from the following options.

- **WebManager Alertlog**
This sends messages to the alert view of the WebManager.
- **Alert Extension**
This executes the specified function by using the alert extension function. Modify the extension settings by using **Add** and/or **Edit**. (The command must be specified within four lines.)
- **Mail Report**
Uses the mail report function.
- **Event Log (Disable only)**
You can disable the settings whereby the OS reports logs to the event log by clearing this check box. (You cannot configure the settings to report messages that are not reported to event logs.)
- **SNMP Trap**
Uses the SNMP trap transmission function to send messages.

Add

Add a command of the alert extension function. Click **Add** to display the **Enter Command** dialog box.

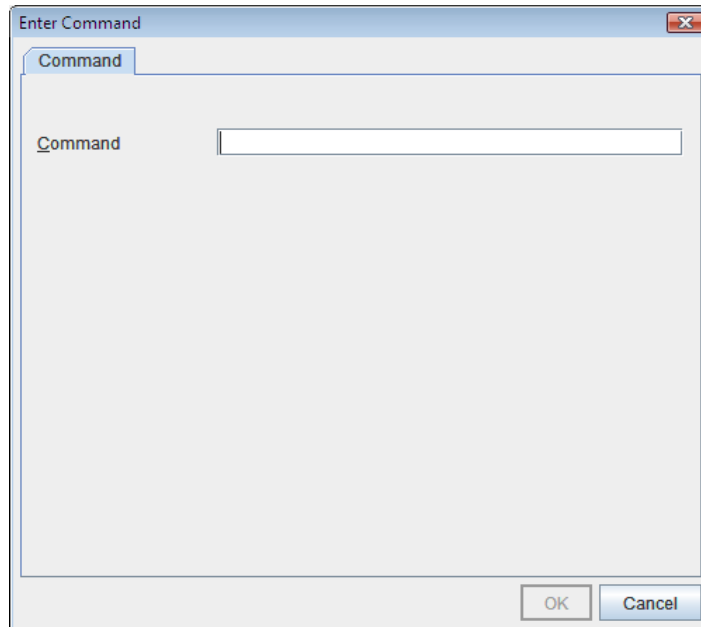

Command (Within 511 bytes)

Enter any command you want to use.

- **Keyword**
If you specify %%MSG%%, the message of the target event ID is inserted.
You cannot specify multiple %%MSG%% for one command.
Configure within 511 bytes including the description of %%MSG%%.
If you set %%MSG%% as an argument for a command, you need to add backslash (\) and double quotation (") like below.

```
<any command you want to use> \"%%MSG%%\"
```

Remove

Click this to remove a command of alert extension function. Select the command and then click **Remove**.

Edit

Click this to modify a command of alert extension function. Select the command and then click **Edit**.

SMTP Settings

Click **SMTP Settings** to display the **SMTP Settings** dialog box used for the mail alert.

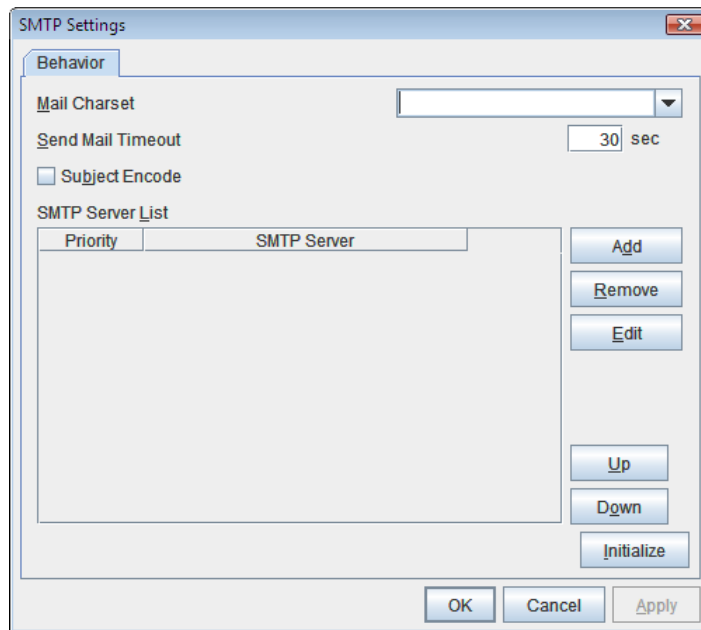
**Mail Charset** (Within 127 bytes)

Configure the character set of the e-mails sent for mail report.

Send Mail Timeout (1 to 999)

Configure the timeout value for communicating with the SMTP server.

Subject Encode

Select whether or not to encode the subject of e-mails.

SMTP Server List

Clicking this displays the configured SMTP servers. No more than four SMTP servers can be configured with this version.

Add

Use this button to add a SMTP server. Click **Add** to display the **Enter the SMTP Server** dialog box.

Remove

Use **Remove** to remove the SMTP server settings.

Edit

Use **Edit** to modify the SMTP server settings.

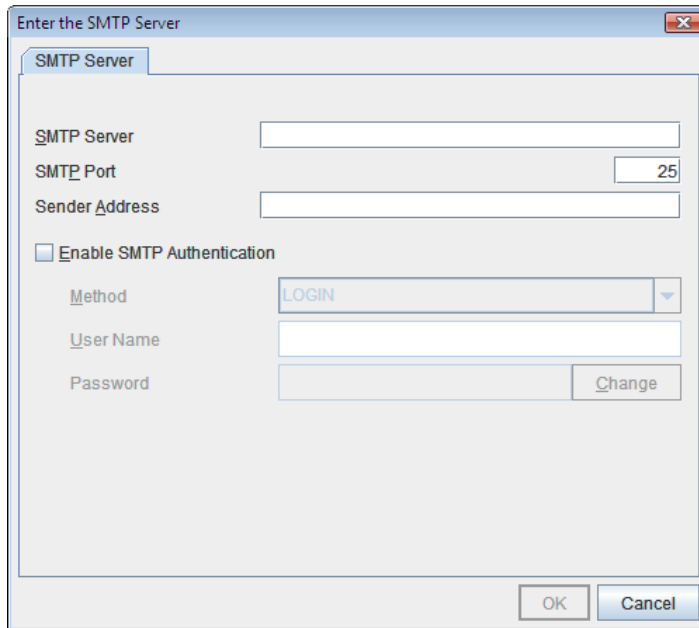

SMTP Server (Within 255 bytes)

Configure the IP address or host name of the SMTP server.

SMTP Port (1 to 65535)

Configure the port number of the SMTP server.

Sender Address (Within 255 bytes)

Configure the address from which an e-mail of mail report is sent.

Enable SMTP Authentication

Configure whether or not to enable SMTP authentication.

Authority method of pop3

Select a method of SMTP authentication.

User Name (Within 255 bytes)

Configure the user name used for SMTP authentication.

Password (Within 255 bytes)

Configure the password used for SMTP authentication.

Remove

Select this to remove the SMTP server.

Edit

Use this button to modify the settings of SMTP server.

SNMP Settings

Click this to display the **Destination Settings** dialog box which is used for the SNMP trap.

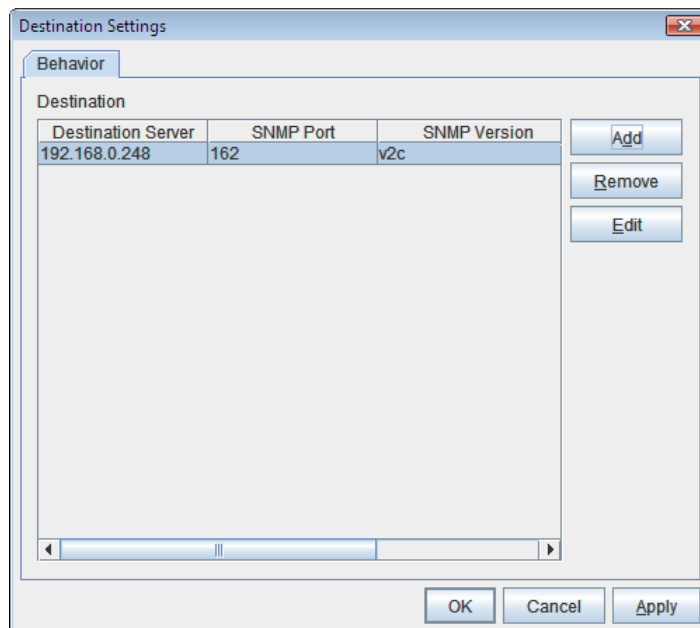

Destination

Displays the set SNMP trap transmission destinations. With this version, up to 32 SNMP trap transmission destinations can be set.

Add

Adds an SNMP trap transmission destination. Click **Add** to display the **Change SNMP Destination** dialog box.

Remove

Use **Remove** to remove the SNMP trap transmission destination settings.

Edit

Use **Edit** to modify the SNMP trap transmission destination settings.

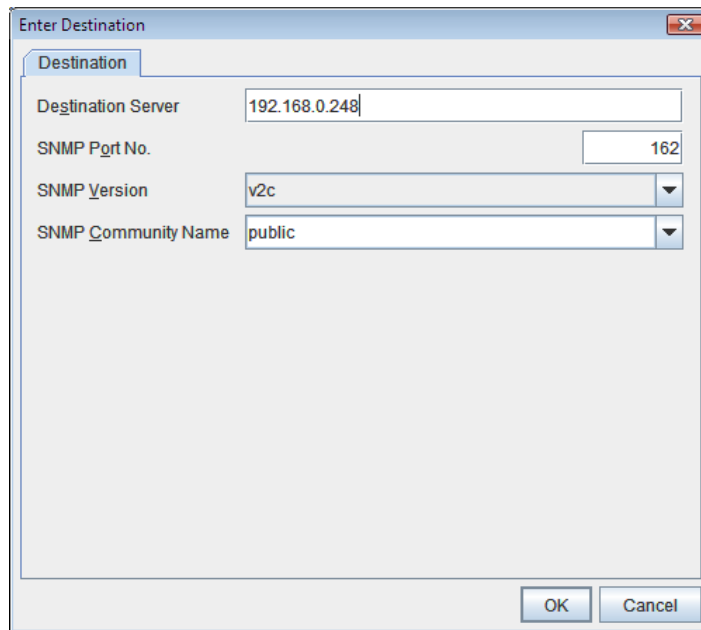

Destination Server (up to 255 bytes)

Configure the name of the SNMP trap transmission destination server.

SNMP Port No. (1 to 65535)

Configure the port number of the SNMP trap transmission destination.

SNMP Version

Configure the SNMP version of the SNMP trap transmission destination.

SNMP Community Name (up to 255 bytes)

Configure the SNMP community name of the SNMP trap transmission destination.

WebManager tab

Use this tab to configure the settings for the WebManager.

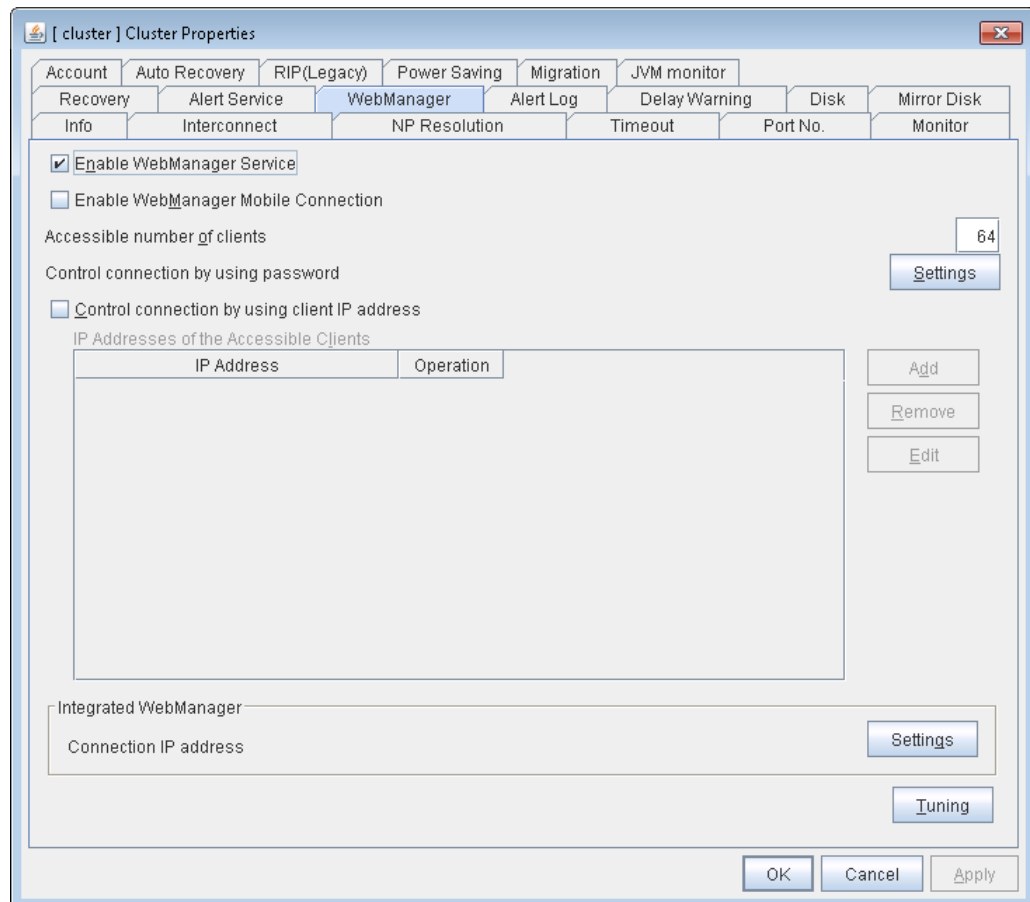

Enable WebManager Service **MStopRestart**

Enables the WebManager Service.

- ◆ When the check box is selected
The WebManager service is enabled.
- ◆ When the check box is not selected
The WebManager service is disabled.

Enable WebManager Mobile Connection **MstopRestart**

Enables the mobile WebManager.

- ◆ When the check box is selected
The WebManager Mobile is enabled.
- ◆ When the check box is not selected
The WebManager Mobile is disabled.

Accessible number of clients (1 to 999) **MStopRestart**

Set the number of requests that can be simultaneously received from clients. If more requests than the number set here are generated, the excess requests will be discarded.

Control connection by using password

Click **Settings** to display the **WebManager Password** dialog box.

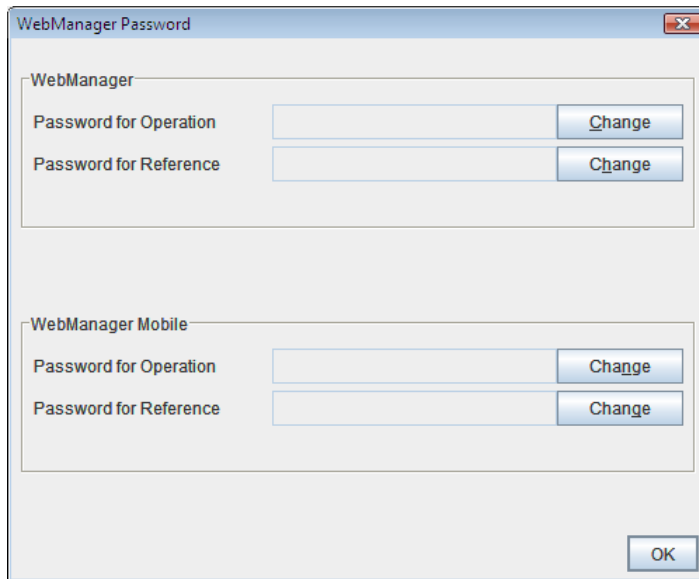

WebManager

◆ **Password for Operation**

Set a password that must be entered to enable connection to the WebManager in the operation mode, config mode, or verification mode.
Click **Change** to display the **Change Password** dialog box.

◆ **Password for Reference**

Set a password that must be entered to enable connection to the WebManager in the reference mode.
Click **Change** to display the **Change Password** dialog box.

WebManager Mobile

◆ **Password for Operation**

Set a password that must be entered to enable connection to the WebManager Mobile in the operation mode.
Click **Change** to display the **Change Password** dialog box.

◆ **Password for Reference**

Set a password that must be entered to enable connection to the WebManager Mobile in the reference mode.
Click **Change** to display the **Change Password** dialog box.

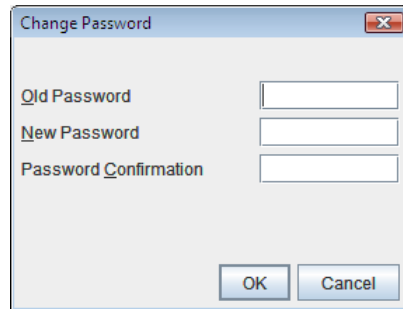

- **Old Password** (Within 255 bytes)
Enter the current password. If the password is not set, leave it blank.
- **New Password** (Within 255 bytes):
Enter a new password. When deleting the old password, leave it blank.
- **Password Confirmation** (Within 255 bytes)
Enter the password again which you entered in **New Password**.
Passwords can consist of one-byte upper- and lower-case letters, digits, symbols, and spaces (0x20 to 0x7E in ASCII code).

Control connection by using client IP address **MStopRestart**

If selected, accesses are controlled by client IP addresses.

- ◆ When the check box is selected
Add, Remove and **Edit** are enabled.
- ◆ When the check box is not selected
Add, Remove and **Edit** are disabled.

Add **MStopRestart**

Use **Add** to add an IP address to **IP Addresses of the Accessible Clients**. Click **Add** to display the **IP Address Settings** dialog box is displayed. Newly added IP addresses have the rights for the operation.

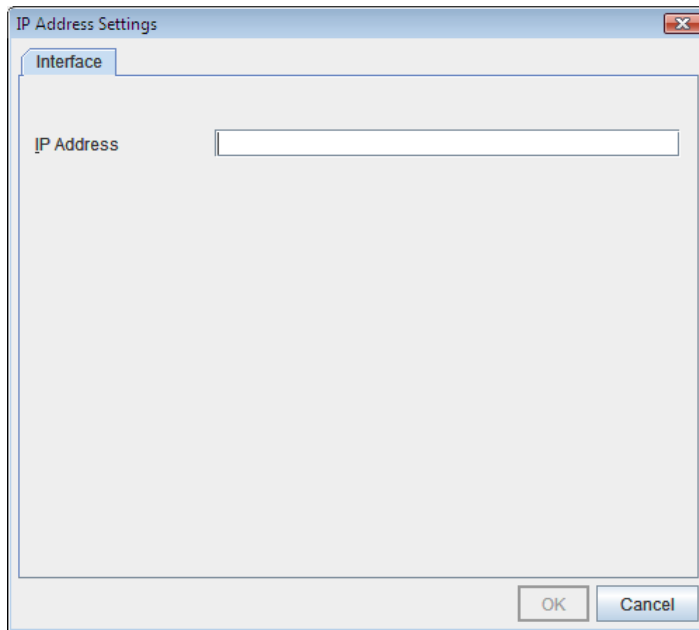

- ◆ **IP Address** (within 80 bytes)
 - Specify a client IP address that can be connected.
 - IP address: 10.0.0.21
 - Network address: 10.0.1.0/24

Remove **MStopRestart**

Use **Remove** to remove an IP address from **IP Addresses of the Accessible Clients**. Select the IP address you want to remove from **IP Addresses of the Accessible Clients** and then click **Remove**.

Edit **MStopRestart**

Use **Edit** to edit an IP address. Select an IP address you want to edit from **IP Addresses of the Accessible Clients** and then click **Edit**. The **IP Address Settings** dialog box where the specified IP address is present is displayed. The rights for operating the edited IP addresses remain the same.

Control column **MStopRestart**

Sets the operation rights for IP addresses that are registered in **IP Addresses of the Accessible Clients**.

- ◆ When the check box is selected
 - A client can operate a cluster and display its status.
- ◆ When the check box is not selected
 - A client can only view the status of a cluster.

IP address for Integrated WebManager

Click **Settings** to display the **IP address for Integrated WebManager** dialog box.

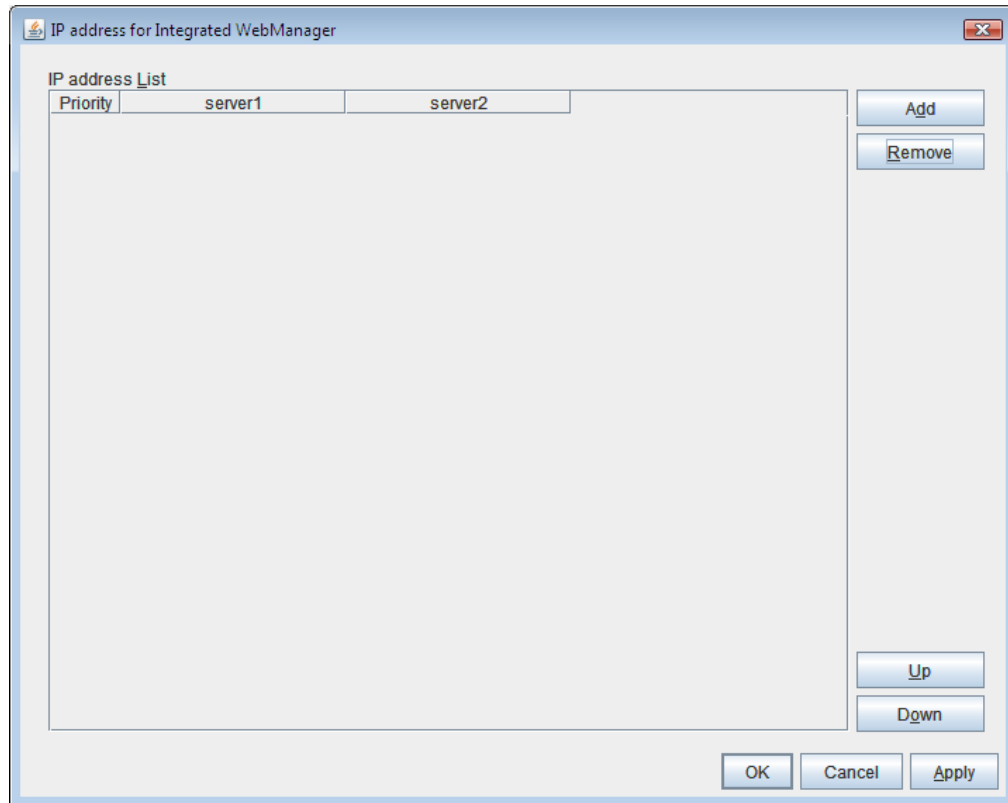

◆ **Add**

Add IP addresses for the Integrated WebManager. Click the column cell of each server and select or enter IP address for the IP address of each server. For the communication path not connected to some server, set blank to the server cell of which the server is not connected.

◆ **Remove**

Remove the communication path. Select the communication path to be removed and click **Remove**, then the selected path is removed.

◆ **Up, Down**

When multiple IP addresses for Integrated WebManager are configured, the communication path with the smallest number in the Priority column is used preferentially for the internal communication among cluster servers. When changing the priority, click **Up** and **Down** to change the order of the selected row.

Tuning Properties

Use **Tuning** to tune the WebManager. Clicking **Tuning** displays the **WebManager Tuning Properties** dialog box.

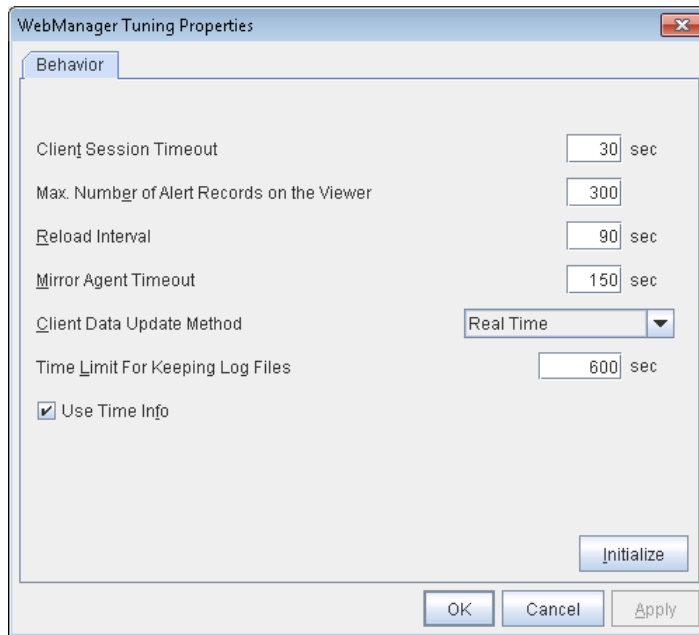

- ◆ **Client Session Timeout (1 to 999)** **MStopRestart**
Specify the client session time-out. A time-out is determined if the time specified here elapses after the last communication between the WebManager Server and the WebManager.
- ◆ **Max. Number of Alert Records on the Viewer (1 to 999)** **MStopRestart**
Specify the maximum number of alert viewer records to display on the Alert Viewer of the WebManager.
- ◆ **Reload Interval (0 to 999)** **MStopRestart**
Specify the screen data update interval. At this time interval, the WebManager screen is refreshed.
- ◆ **Mirror Agent Timeout (1 to 999)** **MStopRestart**
Specify the mirror agent time-out. A time-out is determined if the time specified here elapses till the mirror disk information is acquired.
- ◆ **Client Data Update Method** **MStopRestart**
You can select the method to update the screen data of the WebManager from the following.
 - Polling
The screen data is updated regularly.
 - Real Time
The screen data is updated on the real time.
- ◆ **Time Limit For Keeping Log Files (60 to 43200)** **MStopRestart**
Time limit determines when the log collection information temporarily saved on the server will be deleted. When the time specified here has elapsed, the log collection information will be deleted unless you save the file when the dialog box asking you if you save the log collection information is displayed.

- ◆ **Use Time Info** `SuspendResume` `MstopRestart`
Specify whether the time information display function is enabled or disabled.
 - When the check box is selected
The time information display function is enabled.
 - When the check box is not selected
The time information display function is disabled.
- ◆ **Initialize**
Click Initialize to reset all settings on this dialog to default. Click **Initialize** to set all items to their default values.
- ◆ **The Number Of Clusters That It Searches For At A Time**
Configure the number of clusters to acquire the information at a time when the cluster information is uploaded.

Alert Log tab

Configure the settings for the alert log.

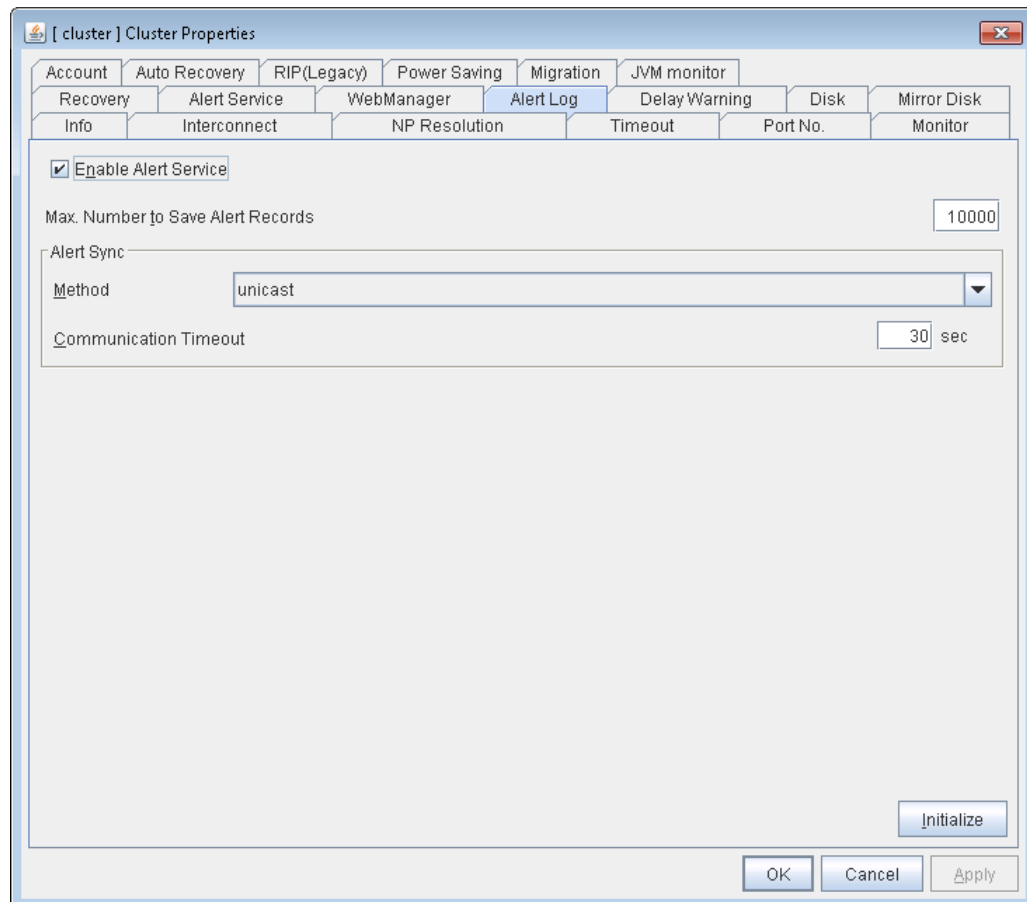

Enable Alert Service **MStopRestart**

Select this to start EXPRESSCLUSTER Web Alert service for the server.

- ◆ When the check box is selected
EXPRESSCLUSTER Web Alert service is enabled.
- ◆ When the check box is not selected
EXPRESSCLUSTER Web Alert service is disabled.

Max. Number to Save Alert Records (1 to 99999) **MStopRestart**

Specify the maximum number of alert records that can be retained. EXPRESSCLUSTER Web Alert service for server can retain alert messages up to this number.

Alert Sync: Method **MStopRestart**

This communication mode is used for Alert Log synchronization. Only unicast is available in **Method** list box for this version.

Alert Sync: Communication Timeout (1 to 300) **MStopRestart**

Specify a communication time-out. A communication time-out is determined if the time specified here elapses after the last communication between EXPRESSCLUSTER Web Alert service and servers.

Initialize

Click **Initialize** to reset all settings on this tab to default. Click **Initialize** to set all items to their default values.

Delay Warning tab

Configure the settings for Delay Warning on this tab. For details on delay warnings, see “Monitor resources – Delay warning of monitor resources” in Chapter 6, “Monitor resource details” in this guide.

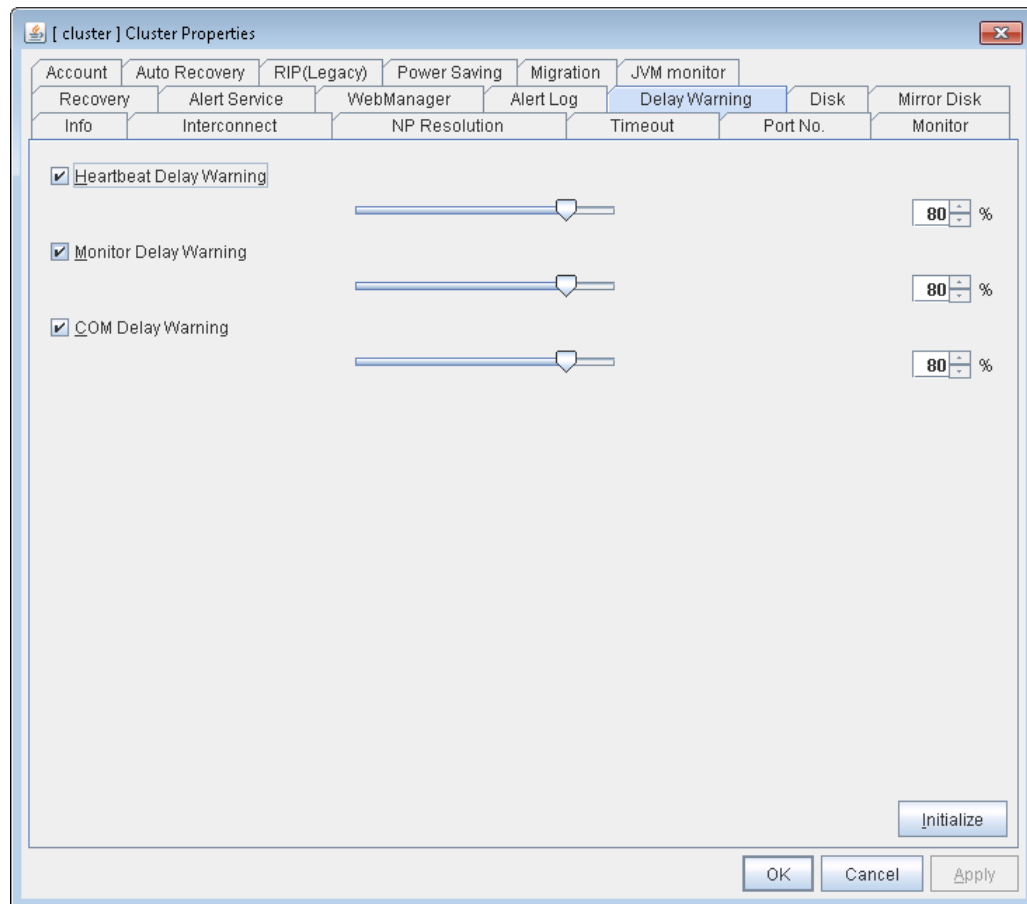

Heartbeat Delay Warning (1 to 99) **Suspend/Resume**

Set a percentage of heartbeat time-out at which the heartbeat delay warning is issued. If the time for the percentage passes without any heartbeat response, the warning will be produced in an alert log.

Monitor Delay Warning (1 to 99) **Suspend/Resume**

Set a percentage of monitor time-out at which the monitor delay warning is issued. If the time for the percentage passes without any monitor response, the warning will be produced in an alert log.

COM Delay Warning (1 to 99) **Suspend/Resume**

Set a percentage of COM I/F delay warning. If the time for the percentage passes without any COM response, the warning will be produced in an alert log.

Disk tab

Configure the setting for a shared disk.

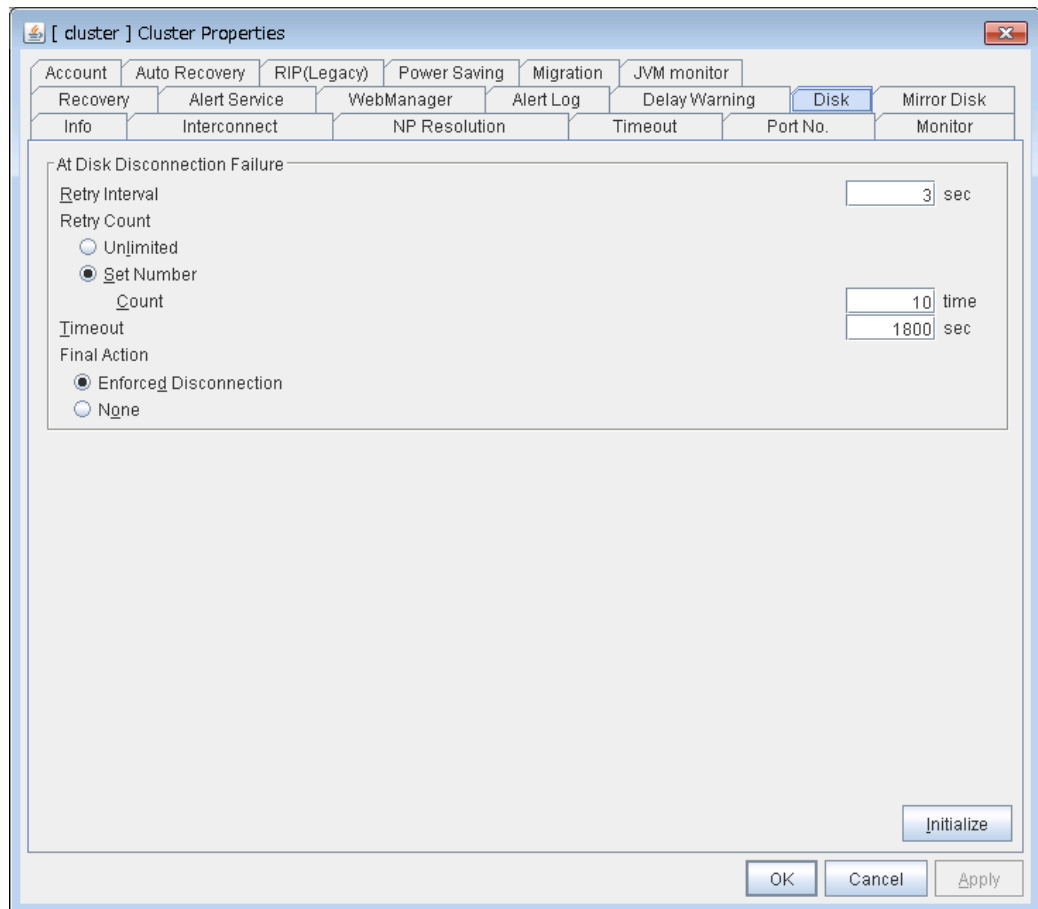

At Disk Disconnection Failure: Retry Interval (1 to 10)

Set the interval time required to retry disconnecting, when disconnecting a shared disk has failed.

At Disk Disconnection Failure: Retry Count (0 to 180)

Set the count to retry disconnecting when disconnecting a shared disk has failed.

- ◆ Unlimited

Select this to retry disconnecting a disk infinitely.

- ◆ Set Number

Select this to specify the count to retry to disconnect a disk.

At Disk Disconnection Failure: Timeout (1 to 9999)

Set the timeout at which to disconnect a shared disk.

At Disk Disconnection Failure: Final Action

If the count to disconnect a shared disk again is specified, set the action that will be taken in the case that disconnecting is failed for the specified count.

- ◆ Enforced Disconnection

Select this to disconnect a disk forcibly.

◆ None

Select this not to disconnect a disk forcibly.

Initialize

This operation is used to return the value to the default value. Click **Initialize** to set all items to their default values.

Note:

If the disk fails to be disconnected, retry or the final action is performed as many times as the value set above for each disk resource deactivation.

However, an emergency shutdown occurs if a single deactivation takes 9999 or more seconds.

To change the retry count and retry interval, set the values in consideration of the above event.

Mirror Disk tab

Configure the setting for a mirror disk.

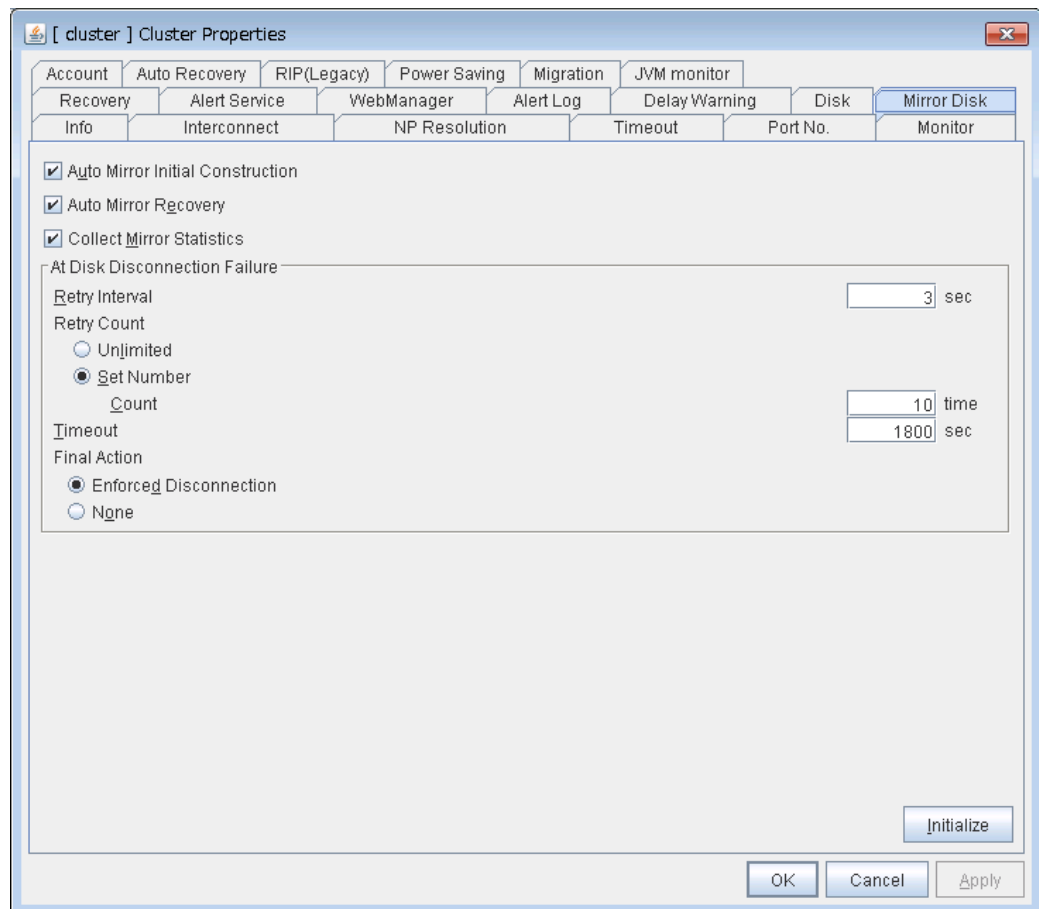

Auto Mirror Initial Construction

Specify whether to perform the mirror initial construction automatically when the newly created mirror disk resource is activated for the first time.

- ◆ When selected
 - Mirror initial construction is performed automatically.
- ◆ When cleared
 - Auto mirror initial construction is not performed

Collect Mirror Statistics

This function can be used to collect and reference information about the mirroring performance. For details, see “Automatically recovering from mirroring” in Chapter 11, “Troubleshooting” in this guide.

- ◆ When selected
 - Mirror Statistics Collection is performed.
- ◆ When cleared
 - Mirror Statistics Collection is not performed.

Auto Mirror Recovery

An automatic mirror recovery is performed when any difference occurs in the data of mirror disks between both servers. There is a case that mirror recovery cannot be performed automatically even if it is selected. For details, see “Troubleshooting Automatically recovering from mirroring” in Chapter 11, “Troubleshooting.” in this guide

- ◆ When selected

Mirror recovery is performed automatically.

- ◆ When cleared

Mirror recovery is not performed automatically.

At Disk Disconnection Failure: Retry Interval (1 to 10)

Set the interval time required to retry disconnecting, when disconnecting a mirror disk has failed.

At Disk Disconnection Failure: Retry Count (0 to 180)

Set the count to retry disconnecting when disconnecting a mirror disk has failed.

- ◆ Unlimited

Select this to retry disconnecting a disk infinitely.

- ◆ Set Number

Select this to specify the count to retry to disconnect a disk.

At Disk Disconnection Failure: Timeout (1 to 9999)

Set the timeout at which to disconnect a mirror disk.

At Disk Disconnection Failure: Final Action

If a retry count is set for mirror disk disconnection, set the action when that will be taken in the case that disconnection still fails after the specified retry count exceeds.

- ◆ Enforced Disconnection

Select this to disconnect a disk forcibly

- ◆ None

Select this not to disconnect a disk forcibly.

Initialize

This operation is used to return the value to the default value. Click **Initialize** to set all items to their default values.

Note:

If the disk fails to be disconnected, retry or the final action is performed as many times as the value set above for each mirror disk resource deactivation.

However, an emergency shutdown occurs if a single deactivation takes 9999 or more seconds.

To change the retry count and retry interval, set the values in consideration of the above event.

Account tab

The **Account** tab is used to register and/or delete the user account that is used in the /U option of the ARMLoad-compatible command. You can set up to sixteen user accounts for one cluster system. The accounts that have already set on the all cluster servers are the target to be registered. The user accounts that are currently registered on the **Account** are displayed.

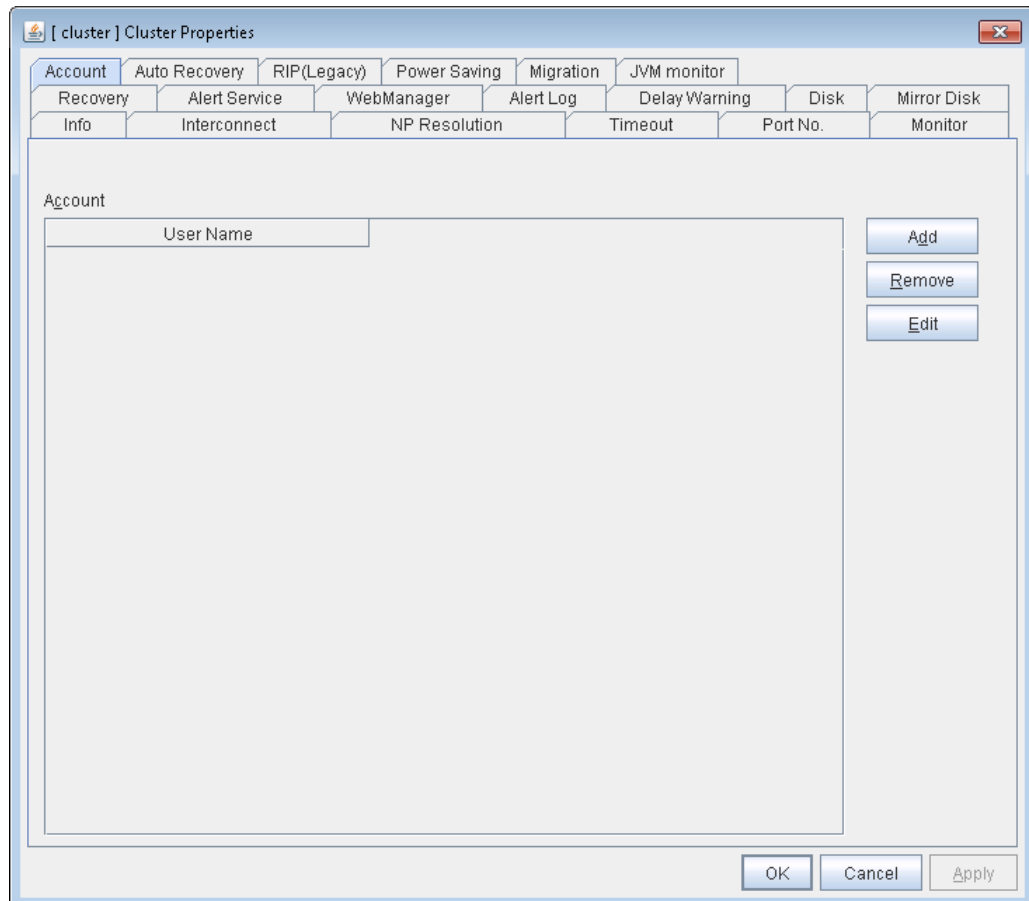

Add

Use **Add** to add a user account on the Account List. Click **Add** to display the **Enter account** dialog box.

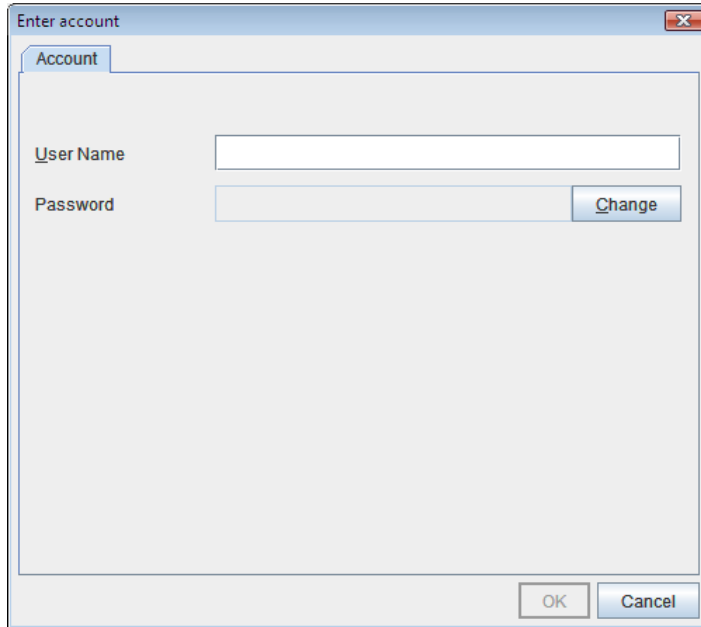

◆ User Name

Enter a user account name to be registered. When specifying an account of a domain, enter, for example, “*Domain Name\Account Name.*”

◆ Password

Enter a password of the user account to be registered.

Remove

Use **Remove** to remove a user account from the Account List. Select the user account you want to remove from **Account** and then click **Remove**.

Edit

Use **Edit** to edit a user account. Select the user account you want to edit from **Account** and then click **Edit**. The **Enter account** dialog box where the selected account was entered is displayed.

Auto Recovery tab

Configure whether to perform “Auto Recovery” when a cluster server is restarted after server failure has occurred.

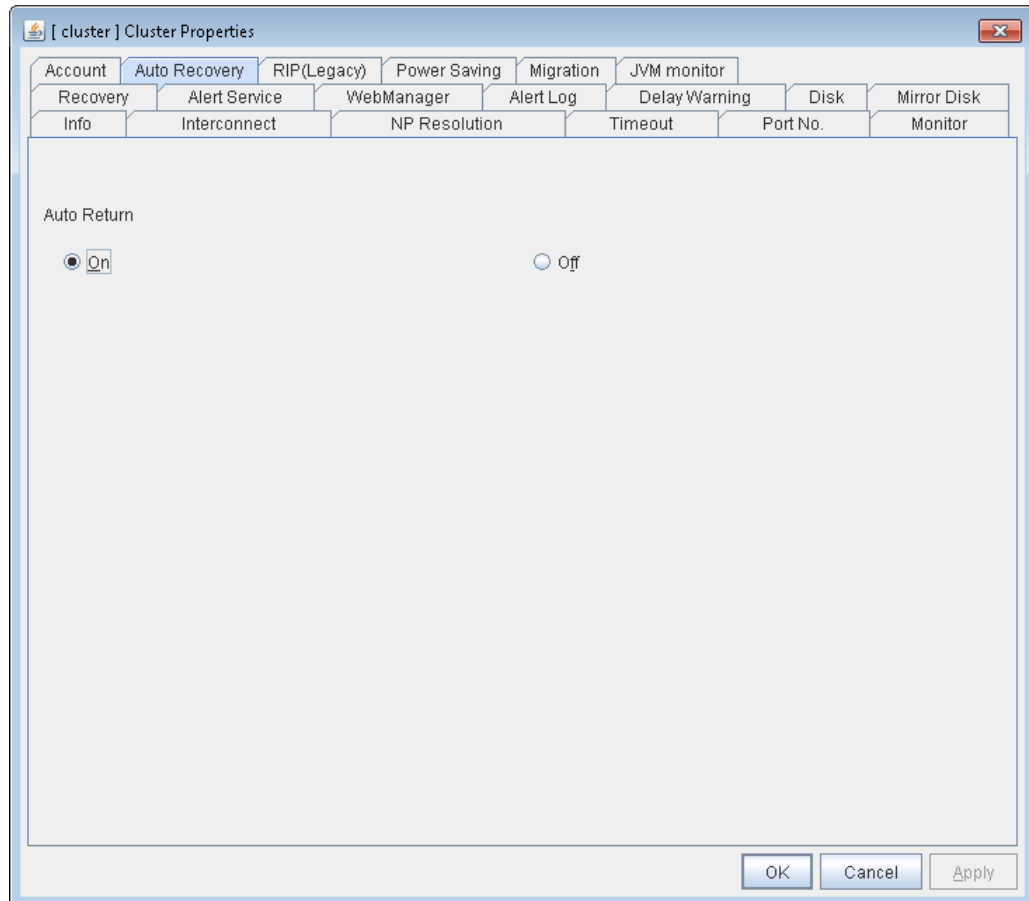

Auto Return

- ◆ On
Select this to perform the auto recovery.
- ◆ Off
Select this not to perform the auto recovery.

RIP (Legacy) tab

With the virtual IP resource configured with the Builder in the older version (X1.0), configure the IP address of the public LAN that sends RIP. As to the version X 3.1, you do not have to configure this in most cases because it is configured at the properties of virtual IP resource. When connecting to the EXPRESSCLUSTER Server from a remote LAN by using a virtual IP address, RIP must be sent to the public LAN which a router is connected to. The broadcast address of the RIP which is set on the cluster is displayed on the **Network Address**.

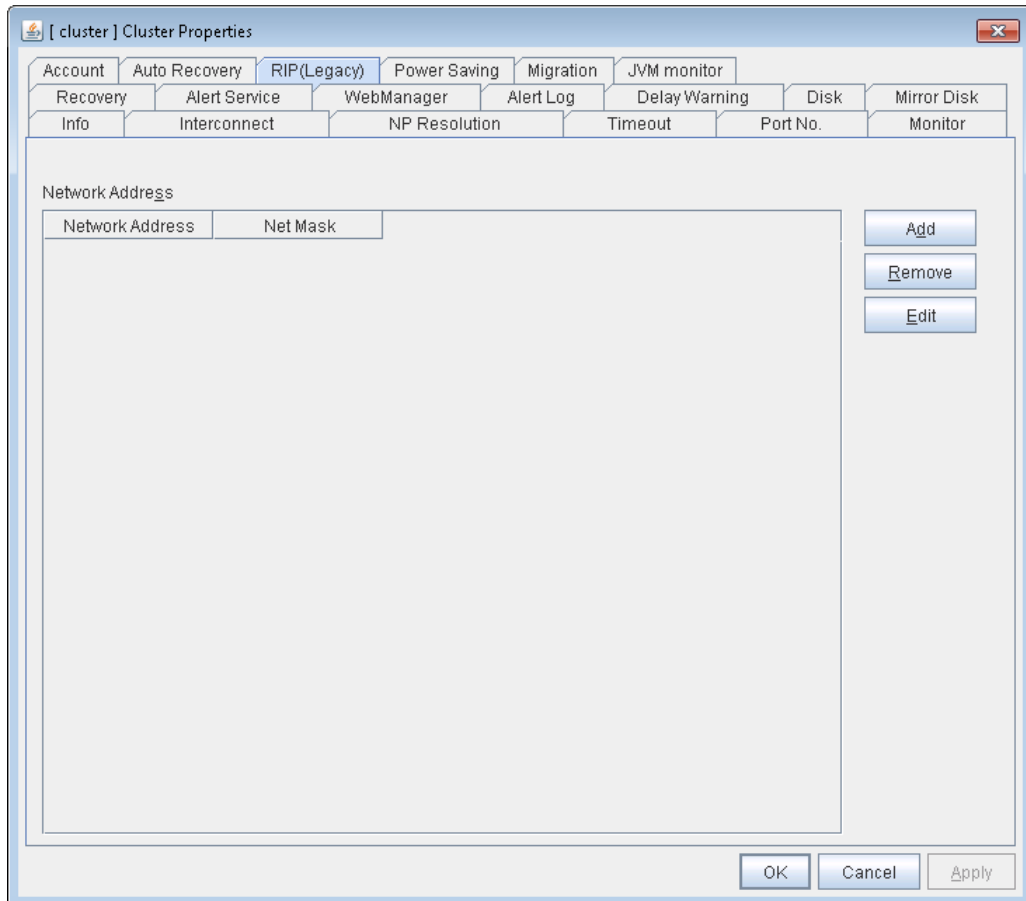

Add

Use **Add** to add a network address to the **Network Address**. Clicking **Add** displays the **Enter network address** dialog box.

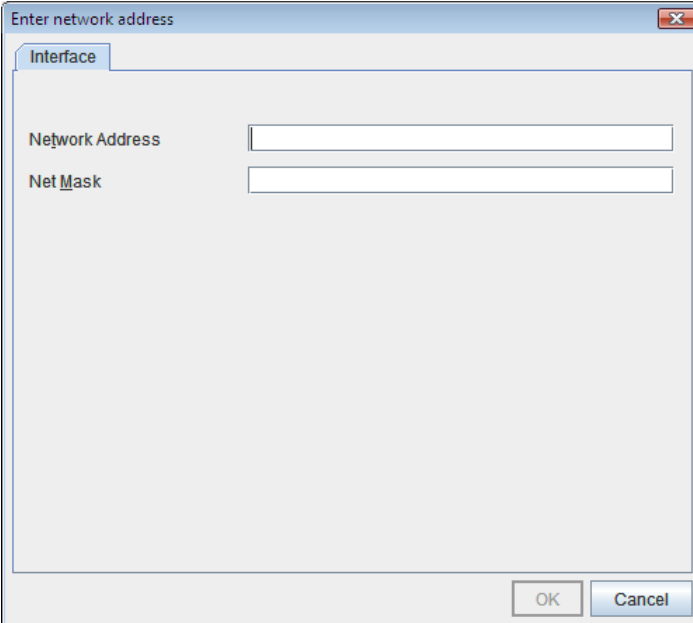

The image shows a Windows-style dialog box titled "Enter network address". It has a close button (X) in the top right corner. Below the title bar is a tab labeled "Interface". The main area of the dialog contains two text input fields: "Network Address" and "Net Mask". At the bottom right, there are "OK" and "Cancel" buttons.

- ◆ Network Address
Enter a network address to be registered.
- ◆ Net Mask
Enter a network mask to be registered.

Remove

Use **Remove** to remove a network address from the **Network Address**. Select the network address you want to remove from the **Network Address** and then click **Remove**.

Edit

Use **Edit** to edit a network address. Select the network address you want to edit from **Network Address** and then click **Edit**. The **Enter network address** dialog box where the selected network address was entered is displayed.

Power saving tab

Configure whether or not to use the function to turn it to power-saving mode by controlling the CPU frequency of the standby server.

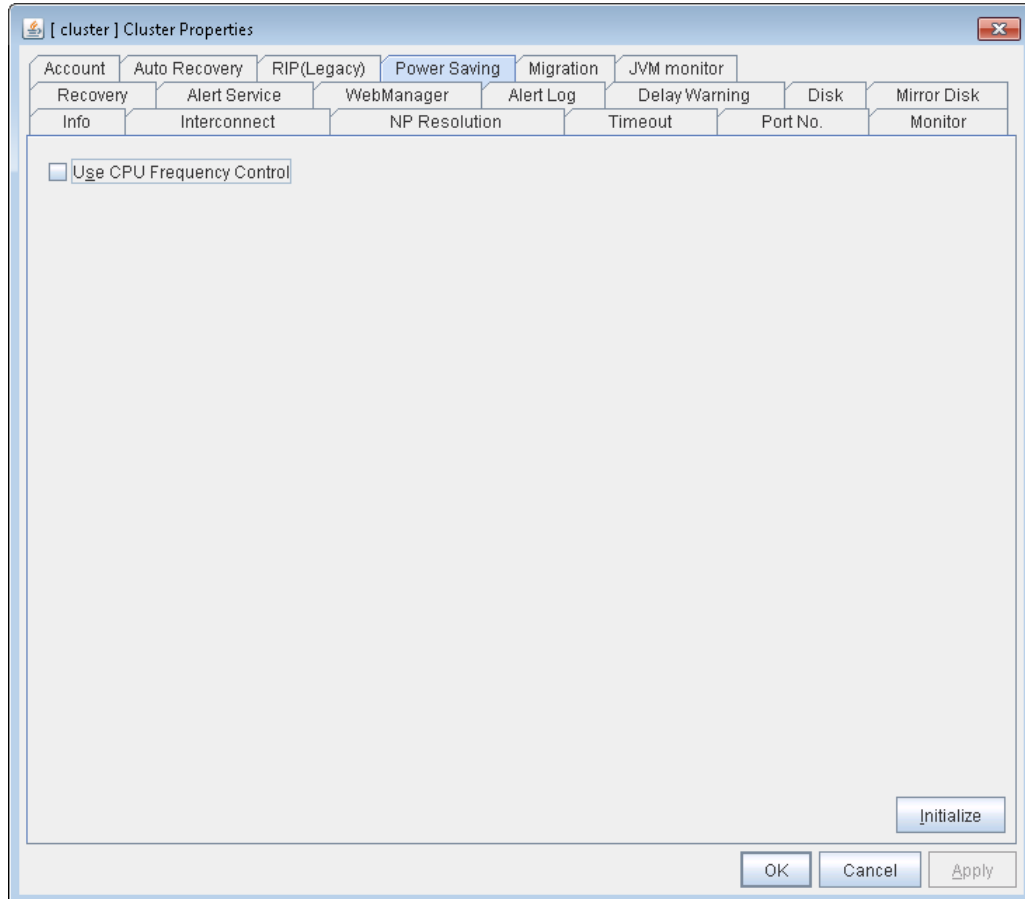

Use CPU Frequency Control

Select the check box when you use CPU frequency control. If you uncheck the check box, CPU frequency control is disabled.

Initialize

This operation is used to return the value to the default value. Click **Initialize** to set the defaults value.

Related Information:

When CPU frequency control is used, the CPU frequency of the server where a failover group is activated is set to high, and that of the server where a failover group is stopped is set to low.

When CPU frequency control is performed by a command or WebManager, the settings changed by the command or WebManager are given higher priority regardless of whether the failover group is started or stopped. Note that the settings changed by the command or WebManager is discarded after the cluster is stopped/started or suspended/resumed, so that CPU frequency is controlled by the cluster.

Note:

For using CPU frequency control, it is required that the frequency is changeable in BIOS settings and the CPU supports the frequency control by Windows OS power management function.

Note:

If you disable CPU frequency control function with CPU frequency changed, the CPU frequency does not return to the state before changing.

In this case, return the CPU frequency to the defined value by the following way.

Windows Server 2003:

Execute the following command at a command prompt.

```
# powercfg /X "Always On" /processor-throttle-ac none
```

The character string to be specified with /X option is the name selected in the current setting of **Power Options -> Power Schemes in Control Panel.**

Windows Server 2008:

Select **Balanced** in **Power Options -> Select a power plan in Control Panel.**

Migration tab

Set the migration of the virtual machine resource.

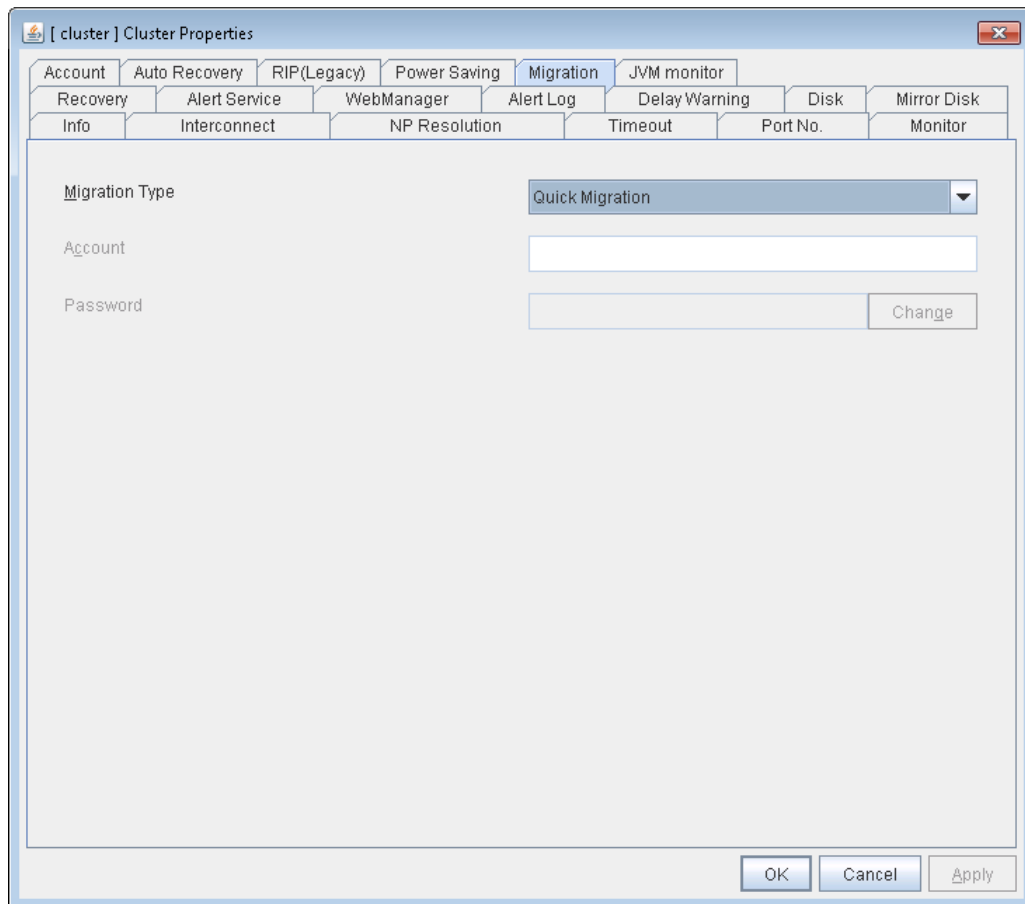

Migration Type

- ◆ Quick Migration
Performs quick migration.
- ◆ Live Migration
Performs live migration.

Account

Enter the name of the user account to be registered. Enter “*domain_name\account_name*.”

Password

Enter the password for the user account to be registered.

JVM monitor tab

Configure detailed parameters for the JVM monitor.

NOTE: To display the **JVM monitor** tab on the online version Builder, you need to execute **Update Server Info** from the **File** menu after the license for Java Resource Agent is registered.

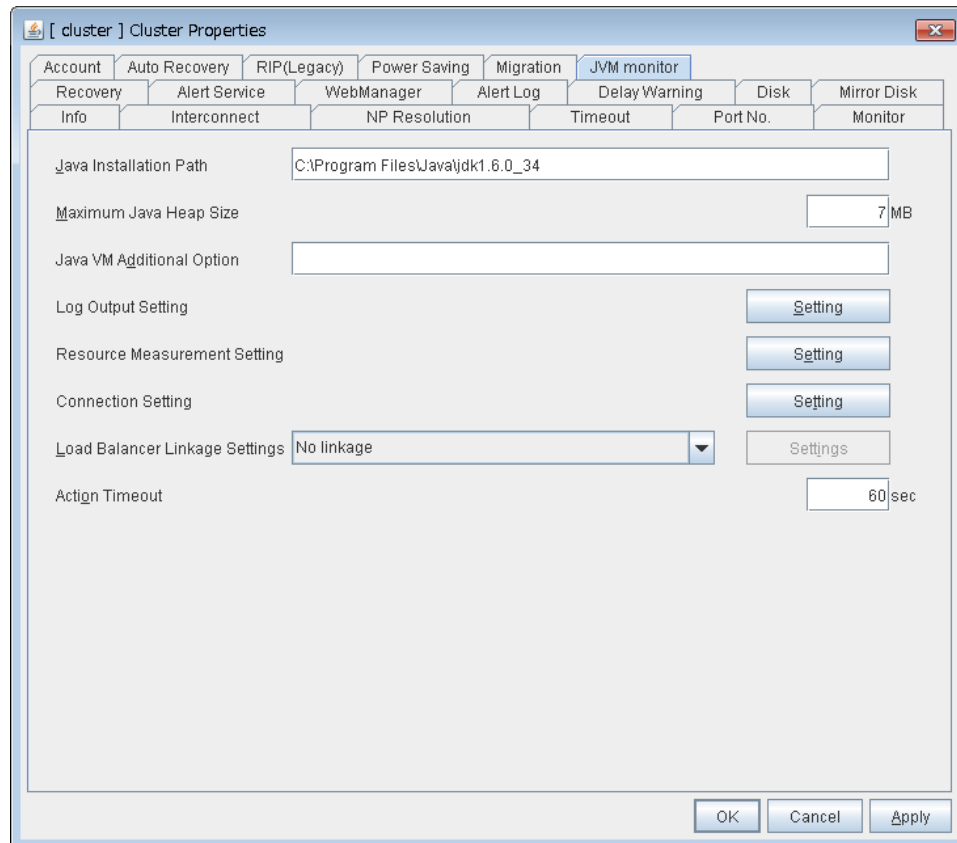

Java Installation Path(up to 255 bytes) **SuspendResume**

Set the Java VM install path used by the JVM monitor. Specify an absolute path using ASCII characters. Do not add “\” to the end of the path. This setting becomes common for all servers in the cluster. Specification example:C:\Program Files\Java\jre6

Maximum Java Heap Size(7 to 4096) **SuspendResume**

Set, in megabytes, the maximum Java VM heap size used by the JVM monitor (equivalent to `-Xmx` of the Java VM startup option). This setting becomes common for all servers in the cluster. If the Oracle Java, specify a value equal to or larger than 7.

Java VM Additional Option (up to 1024 bytes) **SuspendResume**

Set the Java VM startup option used by the JVM monitor. However, specify `-Xmx` for **Maximum Java Heap Size**. This setting becomes common for all the servers in the cluster. Specification example: `-XX:+UseSerialGC`

Log Output Setting

Click the **Setting** button to open the **Log Output Setting** dialog box.

Resource Measurement Setting

Click the **Setting** button to open the **Resource Measurement Setting** dialog box.

Connection Setting

Click the **Setting** button to open the **Connection Setting** dialog box.

Load Balancer Linkage Settings

Select the load balancer type and then click the **Settings** button. The **Load Balancer Linkage Settings** dialog box appears.

Select the load balancer type from the list. To perform load balancer linkage, select the load balancer you are using. To cancel the load balancer linkage, select **No linkage**.

Action Timeout (30 to 300) **SuspendResume**

Set a timeout value for the [Command] that has been specified on each window of the JVM monitor. This setting becomes common for all of the [Commands].

Log Output Setting

Clicking **Setting** displays the **Log Output Setting** dialog box.

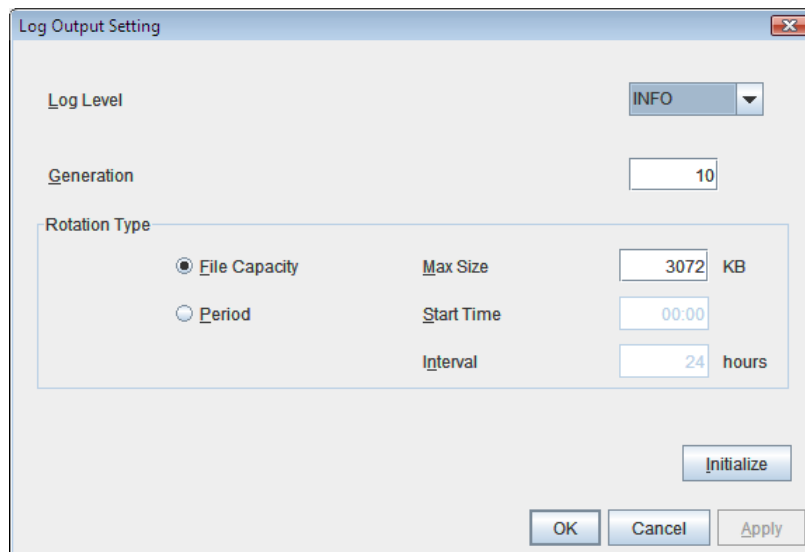

Log Level **SuspendResume**

Select the log level of the log output by the JVM monitor.

Generation (2 to 100) **SuspendResume**

Set the number of generations to be retained for the log output by the JVM monitor.

Rotation Type **SuspendResume**

Select a rotation type for the log output by the JVM monitor. If you select **File Capacity** as the rotation type, set the maximum size (200 to 2097151), in kilobytes, for each log file such as the JVM operation log. If you select **Period** as the rotation type, set the log rotation start time in “hh:mm” format (hh: 0 to 23, mm: 0 to 59) and the rotation interval (1 to 8784) in hours.

Initialize

Clicking **Initialize** returns the log level, generation, and rotation type items to their default values.

Resource Measurement Setting [Common]

Clicking **Setting** displays the **Resource Measurement Setting** dialog box. For details on the scheme for error judgment by the JVM monitor, see Chapter 6, “Monitor resource details.”

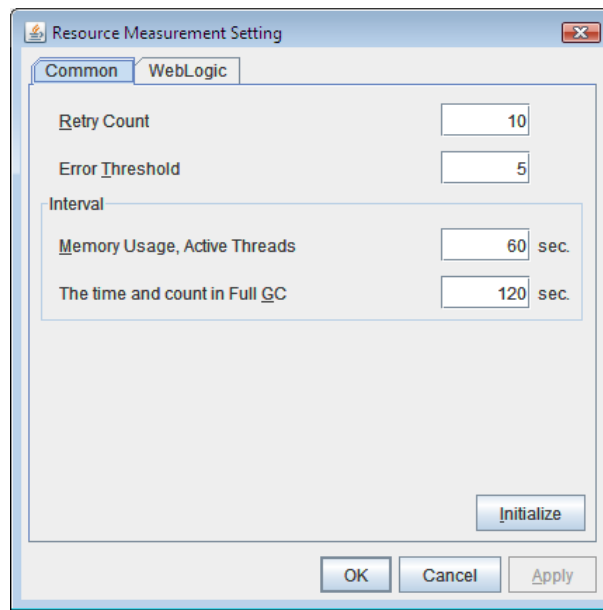
**Retry Count (1 to 1440) `SuspendResume`**

Set the resource measurement retry count to be applied if the JVM monitor fails in resource measurement.

Error Threshold (1 to 10) `SuspendResume`

Set the number of times abnormal judgment is performed when the usage of the Java VM or the application server resources collected by the JVM monitor via resource measurement continuously exceed the customer-defined threshold.

Memory Usage, Active Threads (15 to 600) `SuspendResume`

Set the interval at which the JVM monitor measures the memory usage and active thread count.

The time and count in Full GC (15 to 600) `SuspendResume`

Set the interval at which the JVM monitor measures the time and count in Full GC execution.

Initialize

Clicking **Initialize** returns the retry count, error threshold, and interval items to their default values.

Resource Measurement Setting [WebLogic]

Clicking **Setting** displays the **Resource Measurement Setting** dialog box. For details on the scheme for error judgment by the JVM monitor, see Chapter 5, “Monitor resource details.”

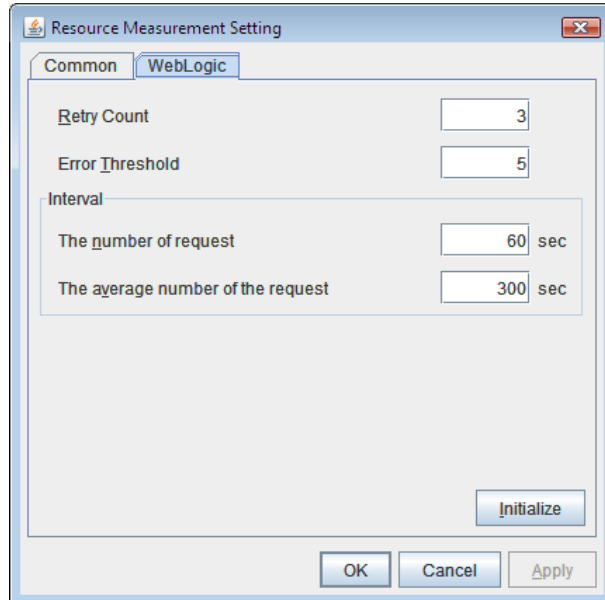

Retry Count (1 to 5) **SuspendResume**

Set the resource measurement retry count to be applied if the JVM monitor fails in resource measurement.

Error Threshold (1 to 10) **SuspendResume**

Set the number of times abnormal judgment is performed when the usage of the Java VM or the application server resources collected by the JVM monitor via resource measurement continuously exceed the customer-defined threshold.

The number of request (15 to 600) **SuspendResume**

Set the interval at which the JVM monitor measures the number of work manager or thread pool requests during WebLogic monitor.

The average number of the request (15 to 600) **SuspendResume**

Set the interval at which the JVM monitor measures the average number of work manager or thread pool requests during WebLogic monitor. Set a value that is an integer multiple of the value set in **Interval: The number of request**.

Initialize

Clicking **Initialize** returns the retry count, error threshold, and interval items to their default values.

Connection Setting

Clicking **Setting** displays the **Connection Setting** dialog box.

Management Port (10000 to 65535) **SuspendResume**

Set the number of the port connected to the monitor target Java VM. This setting becomes common for all the servers in the cluster. Do not set 42424 to 61000.

Management Port (10000 to 65535) **SuspendResume**

Set the number of the port connected to the monitor target Java VM. This setting becomes **Retry Count for** (1 to 5) **SuspendResume**

Set the retry count to be applied if connection to the monitor target Java VM fails.

Waiting time for reconnection (15 to 60) **SuspendResume**

Set the interval at which the JVM monitor retries connection if it fails in Java VM connection.

Initialize

Clicking **Initialize** sets the management port, retry count, and waiting time for reconnection items to their default values.

Load Balancer Linkage Settings

If you select other than **BIG-IP LTM** as the load balancer type and then click the **Settings** button, the **Load Balancer Linkage Settings** dialog box appears.

Management Port for Load Balancer Linkage (10000 to 65535) **SuspendResume**

Set the port number used by the load balancer linkage function. This setting becomes common to all the servers in the cluster. Do not set 42424 to 61000.

Health Check Linkage Function **SuspendResume**

Set whether to use the load balancer health check function if the monitor target Java VM detects a failure.

Directory containing HTML files(up to 255 bytes) **SuspendResume**

Set the directory in which the HTML file used by the load balancer health check function is stored.

HTML File Name(up to 255 bytes) **SuspendResume**

Set the HTML file name used by the load balancer health check function.

HTML Renamed File Name(up to 255 bytes) **SuspendResume**

Set the HTML renamed file name used by the load balancer health check function.

Retry Count for renaming (0 to 5) **SuspendResume**

Set the number of times HTML file renaming is retried if it fails.

Wait time for retry (1 to 60) **SuspendResume**

Set the interval at which HTML file renaming is retried if it fails.

Initialize

Clicking **Initialize** returns the management port for load balancer linkage, health check linkage function, directory containing HTML files, HTML file name, HTML renamed file name, retry count for renaming, and wait time for retry interval items to their default values.

Load Balancer Linkage Settings

Select **BIG-IP LTM** as the load balancer type and then click the **Settings** button. The **Load Balancer Linkage Settings** dialog box appears.

Management Port for Load Balancer Linkage (10000 to 65535) **SuspendResume**

Set the port number used by the load balancer linkage function. This setting becomes common to all the servers in the cluster. Do not set 42424 to 61000.

mgmt IP address **SuspendResume**

Set the BIG-IP LTM IP address.

User Name (up to 255 bytes) **SuspendResume**

Set the BIG-IP LTM management user name.

Password (up to 255 bytes) **SuspendResume**

Set the BIG-IP LTM management user password.

Communication Port (10000 to 65535) **SuspendResume**

Set the communication port number for BIG-IP LTM.

Add **SuspendResume**

Add the server name and IP address for the distributed node. For the server name, specify the computer name. For the IP address, specify the value set to **Members** in **LocalTraffic - Pools:PoolList - Relevant pool - Members** of BIG-IP Configuration Utility. To change the value, select the line and directly edit the description.

Remove **SuspendResume**

Remove the server name and IP address for the distributed node. Select the line to be removed and then click **Remove**. The selected server is removed.

Initialize

Clicking Initialize returns the management port for load balancer linkage, management user name, and communication port number to the default settings.

Servers Properties

Configure setting information of all servers in Servers Properties.

Master Server tab

Configure the priority order of the servers and the server group. All the registered servers are displayed. Master server is the server to keep the master of cluster configuration information. And also, it is the server of the highest priority order.

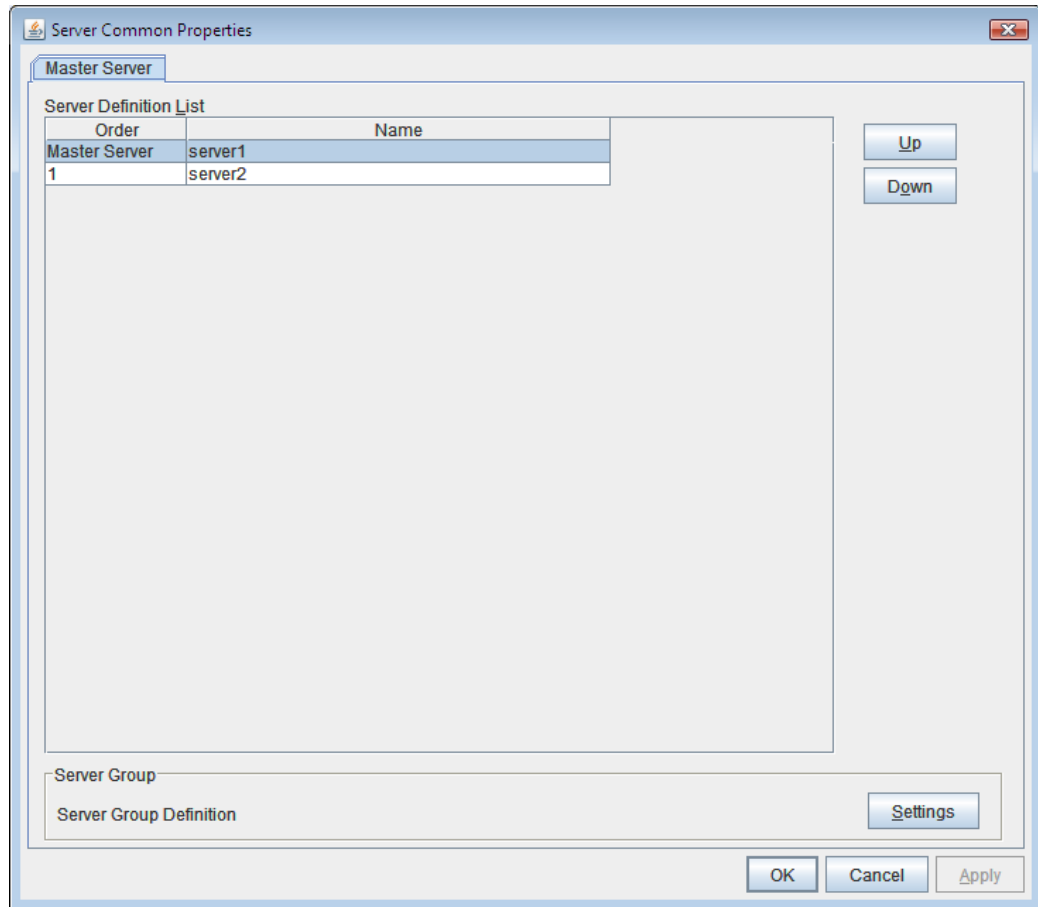

Up, Down

Used when changing the priority order of the servers. Select the server to be changed from the server definition list, and select **Up** or **Down**. The selected row moves.

Settings

Used when configuring the server group. Select **Settings** and the **Server Group** dialog box is displayed.

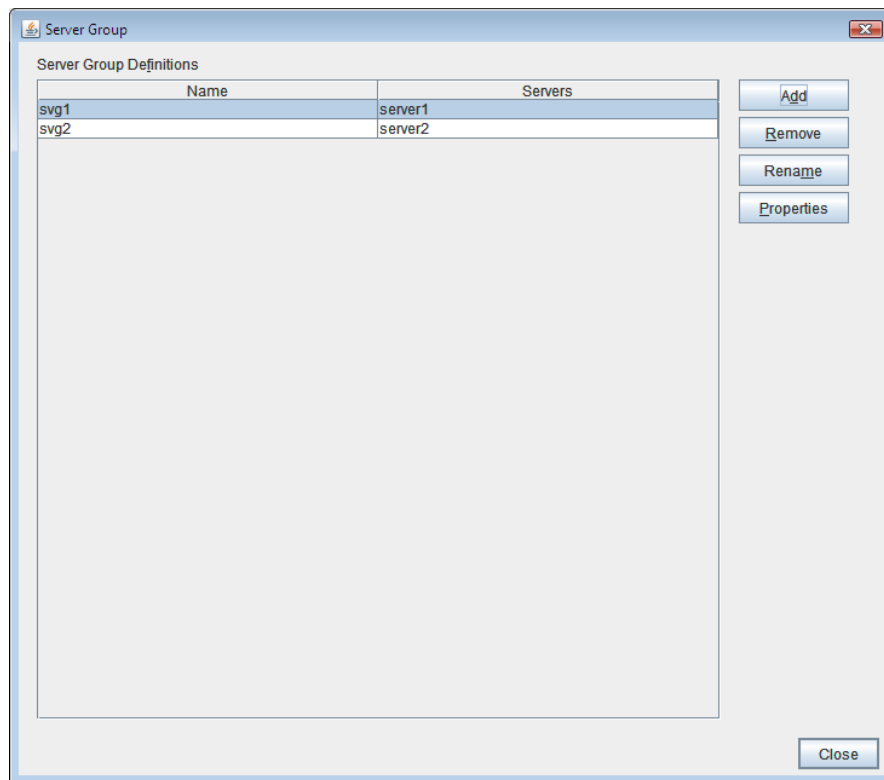

◆ **Add Suspend/Resume**

Add server groups. The wizard windows for adding the server group is displayed. For details, see “Creating the cluster configuration data 1. Create a cluster” in Chapter 5, “Creating the cluster configuration data” in the *Installation and Configuration Guide*.

◆ **Remove Suspend/Resume**

The confirmation dialog box is displayed. When removing, select **Yes**. Then the selected server group is removed. When not removing, select **No**.

When the selected server group is used for the settings of the startup server of the failover group, the server group cannot be removed.

◆ **Rename Suspend/Resume**

The change server group name dialog box of the selected server group is displayed.



There are the following naming rules.

- There are naming rules that are the same as the host name of TCP/IP that can be set by the OS.
- Up to 31 characters (31 bytes).
- Names cannot start or end with a hyphen (-) or a space.
- A name consisting of only numbers is not allowed.

Names should be unique (case-insensitive) in the server group.

◆ **Properties**

Display the properties of the selected server group.

◆ **Name**

Display the server group name.

◆ **Servers**

Display the server names which belong to the server group.

Server Properties

Configure individual settings on each server constructing the cluster in Server Properties.

Info tab

You can display the server name, and register and make a change to a comment on this tab.

Name

The selected server name is displayed. You cannot change the name here.

Comment

You can specify a comment for the server. Only alphanumeric characters are allowed.

Virtual Machine

Specify whether this server is a virtual machine (guest OS).

- ◆ When the check box is selected
 - The server is a virtual machine (guest OS). You can configure this virtual machine.
- ◆ When the check box is not selected
 - The server is a physical machine. You cannot configure a virtual machine.

Type

Specify the type of virtual infrastructure.

- vSphere
Virtual infrastructure provided by VMware, Inc.
- KVM
Linux kernel virtual infrastructure.
- XenServer
Virtual infrastructure provided by Citrix Systems, Inc.
- Container
Virtual infrastructure provided by Oracle, Inc.
- Hyper-V
Virtual infrastructure provided by Microsoft Corporation.
- other
Specify this option to use any other virtual infrastructure.

Forced Stop Setting

Set the information about the virtual machine (guest OS). Click **Setting** to display the **Input for Virtual Machine name** dialog box.

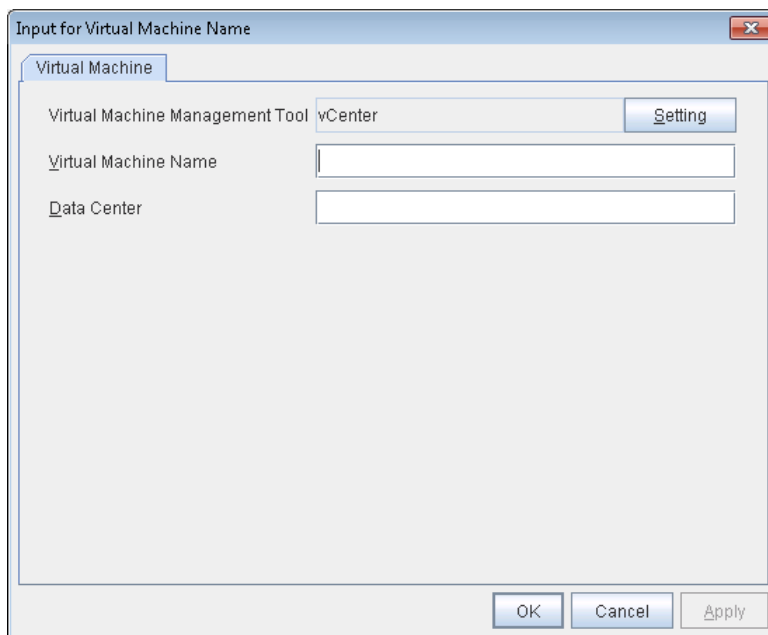

Virtual Machine Management Tool

Set the virtual machine management tool that manages the virtual machine (guest OS). Click **Setting** to display the **Virtual Machine Forced Stop Setting** dialog box.

For details on **Virtual Machine Forced Stop Setting**, refer to the **Recovery** tab.

Virtual Machine name (Within 80 bytes)

Set the virtual machine (guest OS) name.

Note: Do not use a double quotation mark (") or percent sign (%) in the virtual machine name.

Data Center (Within 80 bytes)

Set the name of the data center that manages the virtual machine (guest OS).

Note: Do not use a double quotation mark (") or percent sign (%) in the virtual machine name.

Warning Light tab

Set an IP address of warning light (specified by NEC) controlled by network.

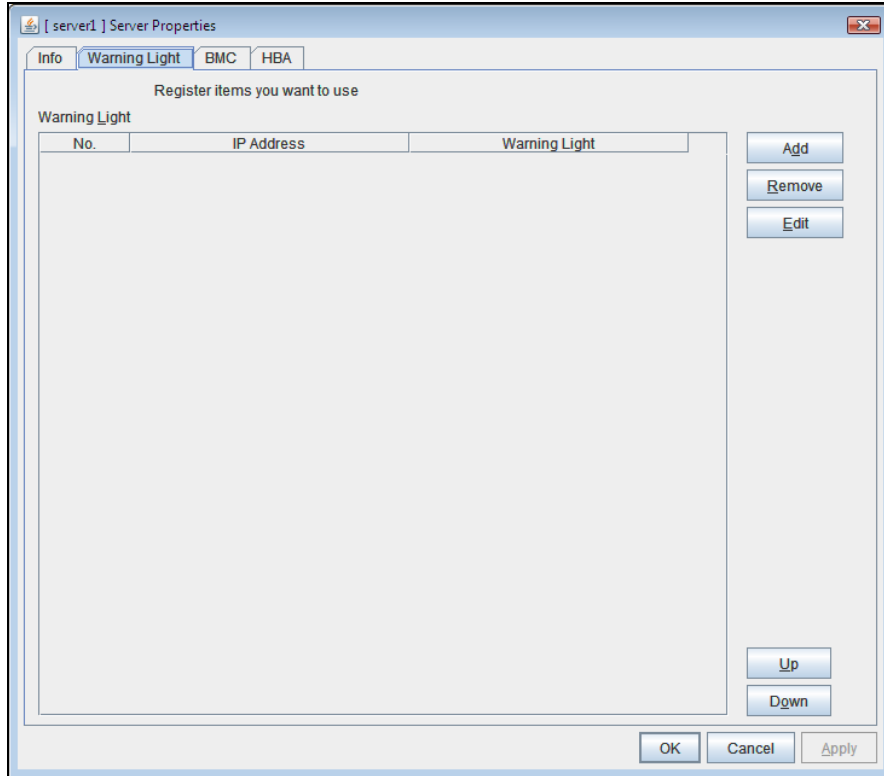

Add

Use this button to add an IP address of warning light. Click **Add** to open the **Warning Light Settings** dialog box.

Remove

Use this button to remove an IP address of warning light. Select the target setting, and then, click **Remove**.

Up

It can't be used because only 1 warning light can be registered at present.

Down

It can't be used because only 1 warning light can be registered at present.

◆ **Warning Light**

Select the product number of the warning light you use. The products corresponding to each number are as follows.

Product Number	Product Name
DN-1000S/DN-1000R/DN-1300GL	DN-1000S/DN-1000R/DN-1300GL
DN-1500GL	DN-1500GL
NH-FB series/NH-FB1 series	NH-FB series/NH-FB1 series
NH-FV1 series	NH-FV1 series

◆ **IP Address (within 80 bytes)**

Enter an IP address of the warning light.

Note:

One warning light is required per one server. Do not set an IP address of the same warning light to multiple servers.

◆ **User Name**

Enter the user name of the execution account on the server used for controlling the warning light. Also, the user name specified here is used as the remote user name for the `rsh` command.

◆ **Password**

Enter the password of the execution account on the server used for controlling the warning light.

Note:

For Windows Server 2008 and Windows Server 2012, enter Administrator for user name, Administrator for password. For Windows Server 2003, you can omit the user name and password.

Specify rsh command execution file path

- ◆ When the check box is selected
 - The `rsh` command execution file path can be specified.
- ◆ When the check box is not selected
 - The `rsh` command execution file path cannot be specified.
- ◆ File path
 - Enter the full path of the `rsh` command to be used for controlling the warning light.
 - Specification example: `C:\WINDOWS\system32\rsh.exe`
- ◆ Playback of an audio file
 - Playback of an audio file is enabled when DN1500GL or NH-FV1 series is selected as the warning light type.
 - If you change the warning light type to other than DN1500GL or NH-FV1 series after playback of an audio file was enabled, playback of an audio file will be disabled.

Alert When Server Starts

- ◆ When the check box is selected
 - Reproduces the audio file at server start. The audio file is reproduced only once.
- ◆ When the check box is not selected
 - Does not reproduce the audio file at server start.
- ◆ Voice File No. (DN1500GL: 01 to 20, NH-FV1 series: 01 to 70)
 - Set the number of the voice file to be reproduced at server start.

Alert When Server Stops

- ◆ When the check box is selected
 - Reproduces the audio file at server stop. The audio file is continuously reproduced until it is stopped manually.
- ◆ When the check box is not selected
 - Does not reproduce the audio file at server stop.
- ◆ Voice File No. (DN1500GL: 01 to 20, NH-FV1 series: 01 to 70)
 - Set the number of the voice file to be reproduced at server stop.

Edit

Use **Edit** to edit the warning light setting.

Note:

To play the audio file, it must be registered in the network warning light.

For more information on audio file registration, refer to the instruction manual of the network warning light to be used.

Set the audio file number corresponding to the audio file that is registered for the network warning light.

BMC tab

Configure a LAN port for managing BMC when using the forced stop and the chassis identify.
Configure one for each server.

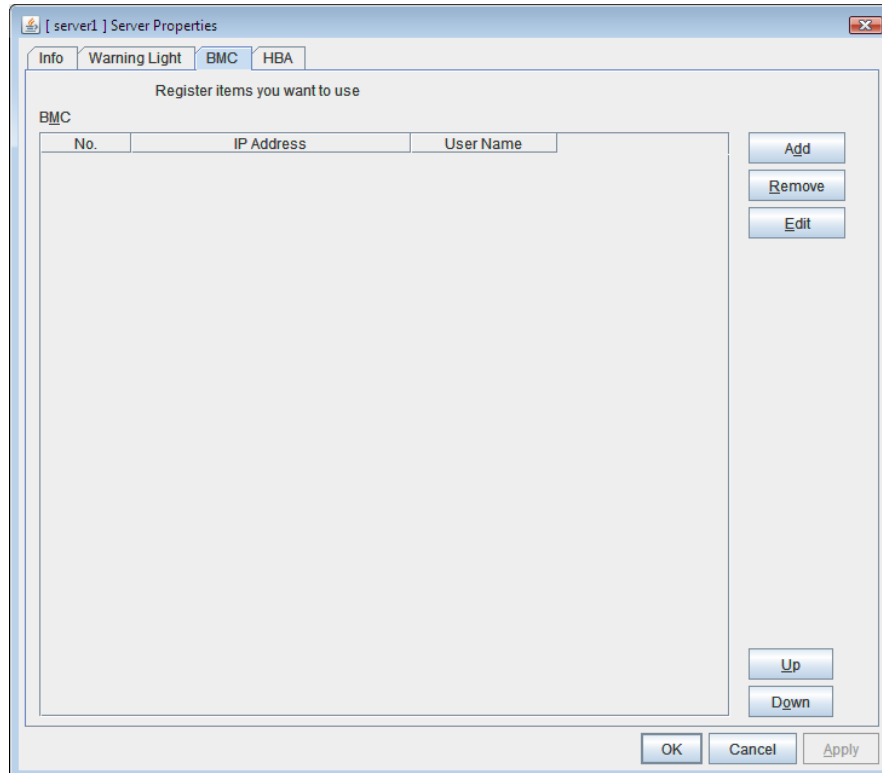

Add **SuspendResume**

Use this button to newly configure new settings. Click **Add** to open the **BMC Settings** dialog box.

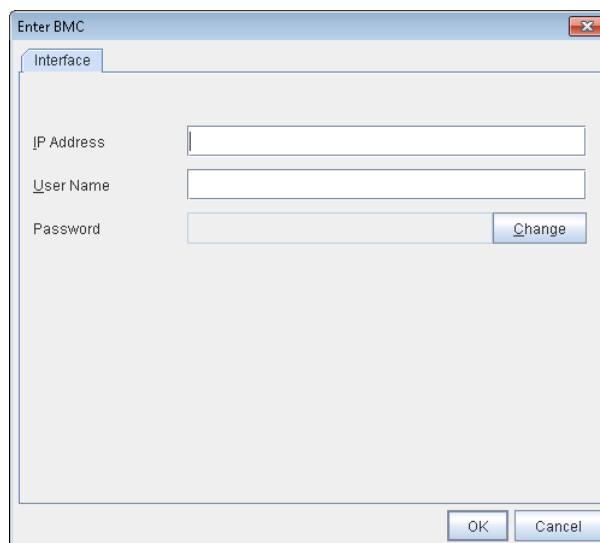

- ◆ IP Address (within 80 bytes) **SuspendResume**
Enter the IP address set for the LAN port for managing BMC.
- ◆ User Name (within 255 bytes) **SuspendResume**
Enter the name of a user with administrator privilege from the user names configured in BMC.

If you do not enter anything, do not configure the user name argument when executing the `hwreset`, `alarms`, `ireset`, or `ialarms` command.

The length of the actually valid user name depends on the `hwreset` command, `alarms` command, `ireset` command, `ialarms` command, and the BMC specifications of the server.
- ◆ Password (within 255 bytes) **SuspendResume**
Enter the password of user configured above.

The length of the actually valid user name depends on the `hwreset` command, `alarms` command, `ireset` command, `ialarms` command, and the BMC specifications of the server.

For information on user name of BMC and how to configure the password, refer to the manual of the server.

Remove **SuspendResume**

Use this button to remove the settings. Select the target setting, and then, click **Remove**.

Edit **SuspendResume**

Use this button to modify the settings. Select the target setting, and then, click **Edit**. The **BMC Settings** dialog box is displayed.

HBA tab

Set the HBA to which the shared disk is connected.

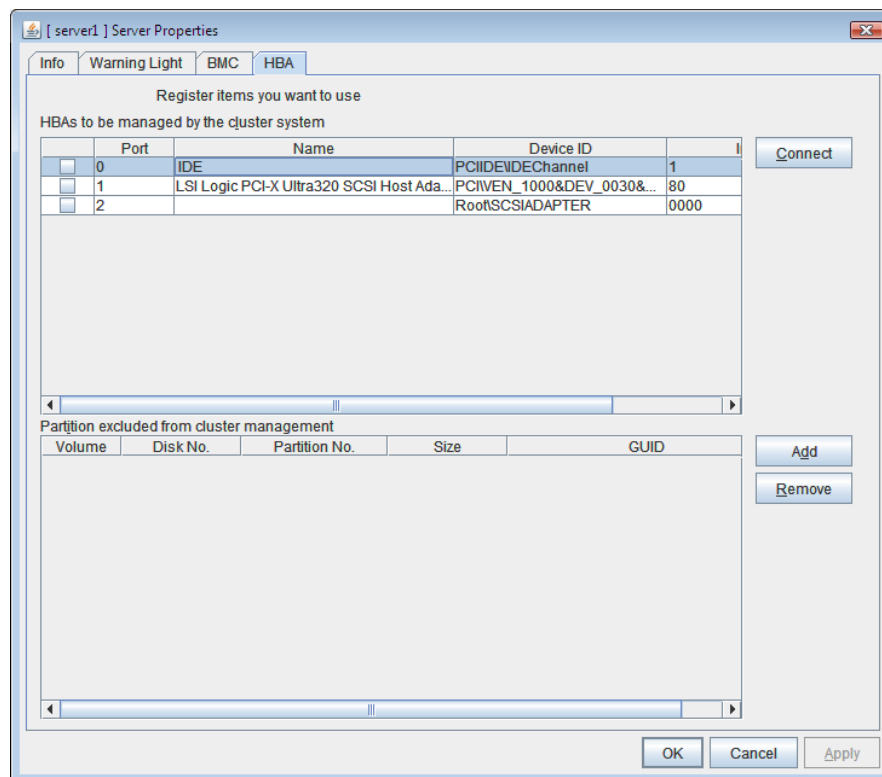

◆ **List of HBAs to be managed by the cluster system** **ShutdownReboot**

Set the access to the shared disk. If the check box is selected, access to all disks connected to the HBA is controlled when starting the OS next time. To protect data, it is required to select the check box of the HBA to which the shared disk is connected.

If the HBA list is not displayed, it can be displayed by clicking the **Connect** button.

Important:

- Do not connect the shared disk to any HBA whose check box is not selected. Even though the check box is selected, do not connect to the shared disk when the OS is not started again after configuring the settings. Data on the shared disk may be corrupted.
 - Do not select the check boxes other than those of HBAs to which the shared disk is connected. If access to the system partition on which the OS has been installed is restricted, the OS may not be started.
 - Do not select the check boxes of HBA that connects the mirroring target internal disk if you use mirror disk resource. Starting mirror disk resource fails.
-

◆ **Partitions excluded from cluster management** **SuspendResume**

When a disk other than the shared disk is connected to the HBA set in **HBAs to be managed by the cluster system**, register the partitions on the disk. The access to the partitions registered with this list is not restricted.

Important:

In principle, do not register the partitions on the shared disk that can be accessed from multiple servers. Data on the shared disk may be corrupted.

Connect

Select this to get the HBA data by connecting to the server.

Add

Add a partition that should not be restricted in its access in **Partition excluded from cluster management**.

Remove

Remove the selected partition from **Partition excluded from cluster management**.

Parameters list

Parameters you can specify in the Builder and their default values are listed below.

“How to change [1]-[6]” represents the way you apply changes of parameters on servers.

Applicable method is marked with “O.” For details of [1]-[6], see “Overview of the Builder” on page 110.

Parameters	Default	How to change					
		1	2	3	4	5	6
Cluster Properties							
Info Tab							
Cluster Name	-			O			
Comment	-						O
Language	English			O		O	
Interconnect Tab							
Priority (Up, Down)	-			O			
Add, Remove	-			O			
[Type] column		O					
[MDC] column		O					
[Server] column: Kernel Mode	-			O		O	
[Server] column: BMC	-			O		O	
[Server] column: Mirror Communication Only		O					
[Server] column: MDC Use		O					
Server Down Notification	On						O
Broadcast/Unicast	Unicast			O			
NP Resolution							
Add, Remove	-			O			
[Type] column	COM			O			
Ping Target	-			O			
[Server] column	-			O			
DISK NP Properties							
I/O Wait Time	80 seconds			O			
Interval	60 seconds			O			
Timeout	300 seconds			O			
Retry Count	0 times			O			
Ping NP Properties							
Interface Tab							
Group - No.				O			
Group - IP Address				O			
IP Address - IP Address				O			
Detailed Settings - Interval	5 seconds			O			
Detailed Settings - Timeout	3 seconds			O			
Detailed Settings - Retry Count	3 times			O			
Network Partition Resolution Tuning Properties							
Action at NP Occurrence	Shutdown			O			
MDC Tab							
MDC (Add, Remove)	-						
[Server] column	-						
Timeout Tab							
Network initialization complete wait time	3 minute						O
Server Sync Wait Time	5 minutes						O
Heartbeat Interval	3 seconds			O			
Heartbeat Timeout	30 seconds			O			
Server Internal Timeout	180 seconds			O		O	
Port No. Tab							
Server Internal Port Number	29001			O		O	
Data Transfer Port Number	29002	O					
WebManager HTTP Port Number	29003					O	
Disk Agent Port Number	29004	O					

Parameters	Default	How to change					
		1	2	3	4	5	6
Mirror Driver Port Number	29005	<input type="radio"/>					
Kernel Mode Heartbeat Port Number	29106			<input type="radio"/>			
Alert Sync Port Number	29003					<input type="radio"/>	
Client Service Port Number	29007	<input type="radio"/>					
Monitor Tab							
Collect the System Resource Information	Off			<input type="radio"/>			
Recovery Tab							
Max Reboot Count	zero			<input type="radio"/>			
Max Reboot Count Reset Time	0 minute			<input type="radio"/>			
Use Forced Stop	Off						<input type="radio"/>
Forced Stop Action	BMC power off						<input type="radio"/>
Forced Stop Timeout	3 seconds						<input type="radio"/>
Virtual Machine Forced Stop Setting							
Virtual Machine Management Tool	vCenter						<input type="radio"/>
Action	Power off						<input type="radio"/>
Timeout	30 seconds						<input type="radio"/>
Command	C:\Program Files (x86)\VMware\VMware vSphere CLI\Perl\apps\vm\vmcontrol.pl						<input type="radio"/>
Host Name	-						<input type="radio"/>
User Name	-						<input type="radio"/>
Password	-						<input type="radio"/>
Execute Script for Forced Stop	Off						<input type="radio"/>
Script Setting							
Select User Application							<input type="radio"/>
Enter application path (Edit)							<input type="radio"/>
Select Script created with this product							<input type="radio"/>
Script content (Edit)							<input type="radio"/>
Timeout	10 [seconds]						<input type="radio"/>
Action When the Cluster Service Process Is Abnormal	Shut down the OS			<input type="radio"/>			
Recovery Action for HA Agents							
Max Restart Count	3 times			<input type="radio"/>			
Recovery Action over Max Restart Count	No operation			<input type="radio"/>			
Disable Recovery Action Caused by Monitor Resource Error.	Off						<input type="radio"/>
Action to apply in the event of an activation/deactivation stall of a group resource	Emergency shutdown			<input type="radio"/>			
Disable the Final Action when OS Stops Due to Failure Detection							
Group Resource When Activation Failure Detected	Off			<input type="radio"/>			
Group Resource When Deactivation Failure Detected	Off			<input type="radio"/>			
Monitor Resource When Failure Detected	Off			<input type="radio"/>			
Disable Shutdown When Multi-Failover-Service Detected							
Server doesn't Shutdown When Multi-Failover-Service Detected	-			<input type="radio"/>			
Alert Service Tab							
Enable Alert Service	Off						<input type="radio"/>
Alert Destination Tab							
Messages (Add, Remove, Edit)	-						<input type="radio"/>
Message Tab							
Category	Process						<input type="radio"/>
Module Type	apisv						<input type="radio"/>
Event ID	-						<input type="radio"/>
Destination WebManager Alert Log	Off						<input type="radio"/>
Destination Mail Report	Off						<input type="radio"/>
Destination SNMP Trap	Off						<input type="radio"/>

Parameters		Default	How to change					
			1	2	3	4	5	6
	Destination Alert Extension	Off						0
	EventLog(DisableOnly)	Off						0
	Command (Add, Remove, Edit)	-						0
	Mail Address	-						0
	Subject	-						0
	Mail Method	SMTP						0
SMTP Settings								
Behavior Tab								
	Mail Charset	-						0
	Send Mail Timeout	30 sec						0
	Subject Encode	Off						0
	SMTP Server (Up, Down)	-						0
	SMTP Server List (Add, Remove)	-						0
Enter the SMTP Server								
	SMTP Server	-						0
	SMTP Port	25						0
	Sender Address	-						0
	Enable SMTP Authentication	Off						0
	Method	LOGIN						0
	User name	-						0
	Password	-						0
	Use Chassis Identify	Off	0					
	Use Network Warning Light	Off			0			
Behavior Tab								
	Destination (Add, Remove, Edit)	-						0
Destination Tab								
	Destination Server	-						0
	SNMP Port No.	162						0
	SNMP Version	v2c						0
	SNMP Community Name	public						0
WebManager Tab								
	Enable WebManager Service	On						0
	Enable WebManager Mobile Connection	Off						0
	Accessible number of clients	64						0
WebManager Password								
	Password for Operation							0
	Password for Reference							0
WebManager Mobile Password								
	Password for Operation							0
	Password for Reference							0
	Control connection by using client IP address	Off						0
	IP Addresses of the Accessible Clients (Add, Remove, Edit)	-						0
	Operation	On						0
IP address for Integrated WebManager								
	Priority (Up, Down)	-			0			
	[Server] column	-			0			
WebManager Tuning Properties								
Behavior Tab								
	Client Session Timeout	30 seconds						0
	Max. Number of Alert Records on the Viewer	300						0
	Screen Data Refresh Interval	90 seconds						0
	Mirror Agent Timeout	150 seconds						0
	Client Data Update Method	Real Time						0
	Time Limit For Keeping Log Files	600 seconds						0
	Use Time Information Display Function	On			0			0
Alert Log Tab								
	Enable Alert Service	On						0
	Max. Number to Save Alert Records	10000						0

Parameters	Default	How to change					
		1	2	3	4	5	6
Alert Sync Method	Unicast (fixed)					<input type="radio"/>	
Alert Sync Communication Timeout	30 seconds					<input type="radio"/>	
Delay Warning Tab							
Heartbeat Delay Warning	On 80%			<input type="radio"/>			
Monitor Delay Warning	On 80%			<input type="radio"/>			
COM Delay Warning	On 80%			<input type="radio"/>			
Disk Tab							
At Disk Disconnection Failure: Retry Interval	3 seconds						<input type="radio"/>
At Disk Disconnection Failure: Retry Count	Set Number						<input type="radio"/>
At Disk Disconnection Failure: Retry Count: Set Number	10 times						<input type="radio"/>
At Disk Disconnection Failure: Timeout	1800 seconds						<input type="radio"/>
At Disk Disconnection Failure: Final Action	Enforced Disconnection						<input type="radio"/>
Mirror Disk Tab							
Auto Mirror Initial Construction	On						<input type="radio"/>
Auto Mirror Recovery	On						<input type="radio"/>
Collect Mirror Statistics	On						<input type="radio"/>
At Disk Disconnection Failure: Retry Interval	3 seconds						<input type="radio"/>
At Disk Disconnection Failure: Retry Count	Set Number						<input type="radio"/>
At Disk Disconnection Failure: Retry Count: Set Number	10 times						<input type="radio"/>
At Disk Disconnection Failure: Timeout	1800 seconds						<input type="radio"/>
At Disk Disconnection Failure: Final Action	Enforced Disconnection						<input type="radio"/>
Account Tab							
Account List (Add, Remove, Edit)	-						<input type="radio"/>
Auto Recovery Tab							
Auto Return	On						<input type="radio"/>
RIP (Legacy) Tab							
List of Network Address (Add, Remove, Edit)	-						<input type="radio"/>
Netmask							<input type="radio"/>
Power Saving Tab							
Use CPU Frequency Control	Off						<input type="radio"/>
Migration Tab							
Migration Type	Quick Migration						<input type="radio"/>
Account	-						<input type="radio"/>
Password	-						<input type="radio"/>
JVM monitor Tab							
Java Installation Path	-			<input type="radio"/>			
Maximum Java Heap Size	7 megabytes			<input type="radio"/>			
Java VM Additional Option	-			<input type="radio"/>			
Action Timeout	60 seconds			<input type="radio"/>			
Log Output Settings							
Log Level	INFO			<input type="radio"/>			
Generation	10 generations			<input type="radio"/>			
Rotation Type	File Capacity			<input type="radio"/>			
Rotation Type, File Capacity, Max Size	3072 kilobytes			<input type="radio"/>			
Rotation Type, Period, Start Time	00:00			<input type="radio"/>			
Rotation Type, Period, Interval	24 hours			<input type="radio"/>			
Resource Measurement Setting [Common]							
Retry Count	10 times			<input type="radio"/>			
Error Threshold	5 times			<input type="radio"/>			
Interval, Memory Usage, Active Threads	60 seconds			<input type="radio"/>			
Interval, The time and count in Full GC	120 seconds			<input type="radio"/>			
Resource Measurement Setting [WebLogic]							
Retry Count	3 times			<input type="radio"/>			
Error Threshold	5 times			<input type="radio"/>			
Interval, The number of request	60 seconds			<input type="radio"/>			
Interval, The average number of the request	300 seconds			<input type="radio"/>			
Connection Settings							

BMC Tab								
Number (Add, Remove)	The Order you added			<input type="radio"/>				
IP Address (Edit)	-			<input type="radio"/>				
User Name	-			<input type="radio"/>				
Password	-			<input type="radio"/>				
HBA Tab								
HBA's to be managed by the cluster system	-	<input type="radio"/>						
Partition excluded from cluster management	-			<input type="radio"/>				
Add Group				<input type="radio"/>				
Add Management Group				<input type="radio"/>				
Remove Group				<input type="radio"/>	<input type="radio"/>			
Rename Group				<input type="radio"/>	<input type="radio"/>			
Group Properties								
Info Tab								
Type	failover							
Use Server Group Settings	Off		<input type="radio"/>					
Name	-			<input type="radio"/>	<input type="radio"/>			
Comment	-							<input type="radio"/>
Startup Server Tab								
Failover is possible on all servers	On			<input type="radio"/>				
Order (Up, Down)	The order you added to "Servers that can run the Group."			<input type="radio"/>				
Server (Add, Remove)	-			<input type="radio"/>				
Attribute Tab								
Startup Attribute	Auto Startup			<input type="radio"/>				
Failover Attribute	Auto Failover			<input type="radio"/>				
Auto Failover	Use the startup server settings			<input type="radio"/>				
Perform a Forced Failover	Off			<input type="radio"/>				
Prioritize failover policy in the server group	Off			<input type="radio"/>				
Perform a Smart Failover	Off			<input type="radio"/>				
Enable only manual failover among the server groups	Off			<input type="radio"/>				
Failback Attribute	Manual Failback			<input type="radio"/>				
Failover Exclusive Attribute	Off			<input type="radio"/>				
Dynamic Failover Exclusive List	ip monitor NIC Link Up/Down monitor			<input type="radio"/>				
Logical Service Tab								
Logical Service Name (Add, Remove)	-							<input type="radio"/>
Start Dependency Tab								
Dependent Group	-			<input type="radio"/>				
Start Wait Time	1800 seconds			<input type="radio"/>				
Dependent Group Property								
Wait Only when on the Same Server	Off			<input type="radio"/>				
Stop Dependency Tab								
Dependent Group	-			<input type="radio"/>				
Stop Wait Time	1800 seconds			<input type="radio"/>				
Wait the Dependent Groups when a Cluster Stops	On							<input type="radio"/>
Wait the Dependent Groups when a Server Stops	Off							<input type="radio"/>
Add Resource				<input type="radio"/>	<input type="radio"/>			
Remove Resource				<input type="radio"/>	<input type="radio"/>			
Rename Resource				<input type="radio"/>	<input type="radio"/>			
Resource Common Properties								
Info Tab								
Name	Default value per each resource			<input type="radio"/>	<input type="radio"/>			
Comment								<input type="radio"/>
Dependency Tab								
Follow the default dependence	On			<input type="radio"/>	<input type="radio"/>			
Dependent Resources (Add, Remove)	-			<input type="radio"/>	<input type="radio"/>			
Recovery Operation Tab								
Retry Count	0			<input type="radio"/>				
Failover Target Server	Stable server			<input type="radio"/>				
Failover Threshold	Set as much as the number of			<input type="radio"/>				

	the servers								
Set Number	-								
Final Action at Activation Failure Detection	Default value per each resource								
Execute Script before Final Action	Off								
Script Tab									
Select User Application Enter application path (Edit)									
Select Script created with this product Script content (Edit)									
Timeout	5 seconds								
Retry Count at Deactivation Failure	0								
Final Action at Deactivation Failure	Default value per each resource								
Execute Script before Final Action	Off								
Script Tab									
Select User Application Enter application path (Edit)									
Select Script created with this product Script content (Edit)									
Timeout	5 seconds								
Application Resource Properties									
Dependency Tab									
Follow the default dependence	On • CIFS resource • disk resource • floating ip resource • hybrid disk resource • mirror disk resource • NAS resource • print spooler resource • registry synchronization resource • virtual computer name resource • virtual IP resource • AWS elastic ip resource • AWS virtual ip resource • Azure probe port resource								
Dependent Resources (Add, Remove)	-								
Recovery Operation Tab									
Retry Count at Activation Failure	0								
Failover Target Server	Stable server								
Failover Threshold	Set a value equal to the number of servers								
Specify the count	-								
Final Action at Activation Failure Detection	No Operation (Not activate next resources)								
Execute Script before Final Action	Off								
Retry Count at Deactivation Failure	0								
Final Action at Deactivation Failure	Stop the cluster service and shut down OS.								
Execute Script before Final Action	Off								
Details Tab									
Resident Type	Resident								
Start Path	-								
Stop Path	-								
Application Resource Tuning Properties									
Parameter Tab									
Start Script Synchronous, Asynchronous	Synchronous								
Start Script Timeout	1800 seconds								
Start Script Normal Return Value	-								
Stop Script Synchronous, Asynchronous	Synchronous								

	Stop Script Timeout	1800 seconds			<input type="radio"/>			
	Stop Script Normal Return Value	-						<input type="radio"/>
	Target VCOM Resource Name	-				<input type="radio"/>		
	Allow to Interact with Desktop	Off				<input type="radio"/>		
	Forcibly Terminate Application When Stopping	Off						<input type="radio"/>
	Start Tab							
	Current Directory	-						<input type="radio"/>
	Option Parameter	-						<input type="radio"/>
	Window Size	Hide						<input type="radio"/>
	Exec User Domain	-				<input type="radio"/>		
	Exec User Account	-				<input type="radio"/>		
	Exec User Password	-				<input type="radio"/>		
	Execute from the Command Prompt	Off						<input type="radio"/>
	Stop Tab							
	Current Directory	-						<input type="radio"/>
	Option Parameter	-						<input type="radio"/>
	Window Size	Hide						<input type="radio"/>
	Exec User Domain	-				<input type="radio"/>		
	Exec User Account	-				<input type="radio"/>		
	Exec User Password	-				<input type="radio"/>		
	Execute from the Command Prompt	Off						<input type="radio"/>
Floating IP Resource Properties								
	Dependency Tab							
	Follow the default dependence	On (No default is set)				<input type="radio"/>	<input type="radio"/>	
	Dependent Resources (Add, Remove)	-				<input type="radio"/>	<input type="radio"/>	
	Recovery Operation Tab							
	Retry Count at Activation Failure	5 times				<input type="radio"/>		
	Failover Target Server	Stable server				<input type="radio"/>		
	Failover Threshold	Set as much as the number of the servers				<input type="radio"/>		
	Specify the count	-				<input type="radio"/>		
	Final Action at Activation Failure Detection	No Operation (Not activate next resources)				<input type="radio"/>		
	Execute Script before Final Action	Off						<input type="radio"/>
	Retry Count at Deactivation Failure	zero				<input type="radio"/>		
	Final Action at Deactivation Failure	Stop the cluster service and shut down OS.				<input type="radio"/>		
	Execute Script before Final Action	Off						<input type="radio"/>
	Details Tab							
	IP Address	-					<input type="radio"/>	
Floating IP Resource Tuning Properties								
	Parameter Tab							
	Run ping	On						<input type="radio"/>
	Ping Interval	1 second				<input type="radio"/>		
	Ping Timeout	1000 milliseconds				<input type="radio"/>		
	Ping Retry Count	5 times				<input type="radio"/>		
	Forced FIP Activation	Off						<input type="radio"/>
	Judges NIC Link Down as abnormal	Off				<input type="radio"/>		
Mirror Disk Resource Properties								
	Dependency Tab							
	Follow the default dependence	On (No default is set)				<input type="radio"/>	<input type="radio"/>	
	Dependent Resources (Add, Remove)	-				<input type="radio"/>	<input type="radio"/>	
	Recovery Operation Tab							
	Retry Count at Activation Failure	3 times				<input type="radio"/>		
	Failover Target Server	Stable server				<input type="radio"/>		
	Failover Threshold	Set as much as the number of the servers				<input type="radio"/>		
	Specify the count	-				<input type="radio"/>		
	Final Action at Activation Failure Detection	No Operation (Not activate next resources)				<input type="radio"/>		
	Execute Script before Final Action	Off						<input type="radio"/>

	• NAS resource								
Dependent Resources (Add, Remove)	-								
Recovery Operation Tab									
Retry Count at Activation Failure	zero								
Failover Target Server	Stable server								
Failover Threshold	Set as much as the number of the servers								
Specify the count	-								
Final Action at Activation Failure Detection	No Operation (Not activate next resources)								
Execute Script before Final Action	Off								
Retry Count at Deactivation Failure	zero								
Final Action at Deactivation Failure	Stop the cluster service and shut down OS.								
Execute Script before Final Action	Off								
Details Tab									
Printer Name	-								
Partition	-								
Spool Directory	-								
Virtual Computer Name Resource Properties									
Dependency Tab									
Follow the default dependence	On • floating IP resources • virtual IP resources •AWS elastic ip resource •AWS virtual ip resource •Azure probe port resource								
Dependent Resources (Add, Remove)	-								
Recovery Operation Tab									
Retry Count at Activation Failure	5 times								
Failover Target Server	Stable server								
Failover Threshold	Set as much as the number of the servers								
Specify the count	-								
Final Action at Activation Failure Detection	No Operation (Not activate next resources)								
Execute Script before Final Action	Off								
Retry Count at Deactivation Failure	zero								
Final Action at Deactivation Failure	Stop the cluster service and shut down OS.								
Execute Script before Final Action	Off								
Details Tab									
Virtual Computer Name	-								
Target FIP Resource Name	-								
Virtual Computer Name Resource Tuning Properties									
Parameter Tab									
Dynamic Registration to DNS	Off								
Associated IP address	FIP								
Virtual IP Resource Properties									
Dependency Tab									
Follow the default dependence	On (No default is set)								
Dependent Resources (Add, Remove)	-								
Recovery Operation Tab									
Retry Count at Activation Failure	5 times								
Failover Target Server	Stable server								
Failover Threshold	Set as much as the number of the servers								
Specify the count	-								
Final Action at Activation Failure Detection	No Operation (Not activate next resources)								
Execute Script before Final Action	Off								
Retry Count at Deactivation Failure	zero								

	Access Permission	everyone read					<input type="radio"/>		
NAS Resource Properties									
Dependency Tab									
	Follow the default dependence	On					<input type="radio"/>	<input type="radio"/>	
	Dependent Resources (Add, Remove)	<ul style="list-style-type: none"> • Floating IP resource • Virtual IP resource •AWS elastic ip resource •AWS virtual ip resource •Azure probe port resource 					<input type="radio"/>	<input type="radio"/>	
Recovery Operation Tab									
	Retry Count at Activation Failure	zero					<input type="radio"/>		
	Failover Target Server	Stable server					<input type="radio"/>		
	Failover Threshold	Set as much as the number of the servers					<input type="radio"/>		
	Specify the count	-					<input type="radio"/>		
	Final Action at Activation Failure Detection	No Operation (Not activate next resources)					<input type="radio"/>		
	Execute Script before Final Action	Off							<input type="radio"/>
	Retry Count at Deactivation Failure	zero					<input type="radio"/>		
	Final Action at Deactivation Failure	Stop the cluster service and shut down OS.					<input type="radio"/>		
	Execute Script before Final Action	Off							<input type="radio"/>
Details Tab									
	Drive	-						<input type="radio"/>	
	Folder	-						<input type="radio"/>	
	User name	-						<input type="radio"/>	
	Password	-						<input type="radio"/>	
NAS Resource Tuning Properties									
Disconnection Tab									
	Retry Count	3					<input type="radio"/>		
	Retry Interval	5 seconds					<input type="radio"/>		
Hybrid Disk Resource Properties									
Dependency Tab									
	Follow the default dependence	On (No default is set)					<input type="radio"/>	<input type="radio"/>	
	Dependent Resources (Add, Remove)						<input type="radio"/>	<input type="radio"/>	
Recovery Operation Tab									
	Retry Count at Activation Failure	3 times					<input type="radio"/>		
	Failover Target Server	Stable server					<input type="radio"/>		
	Failover Threshold	Set as much as the number of the servers					<input type="radio"/>		
	Specify the count	-					<input type="radio"/>		
	Final Action at Activation Failure Detection	No Operation (Not activate next resources)					<input type="radio"/>		
	Execute Script before Final Action	Off							<input type="radio"/>
	Retry Count at Deactivation Failure	zero					<input type="radio"/>		
	Final Action at Deactivation Failure	Stop the cluster service and shut down OS.					<input type="radio"/>		
	Execute Script before Final Action	Off							<input type="radio"/>
Details Tab									
	Hybrid disk number	2					<input type="radio"/>	<input type="radio"/>	
	Data partition drive letter	-					<input type="radio"/>	<input type="radio"/>	
	Cluster partition driver letter	-					<input type="radio"/>	<input type="radio"/>	
	Cluster partition offset index	0					<input type="radio"/>	<input type="radio"/>	
Selection of Mirror Disk Connect									
Mirror Disk Connect Tab									
	Order (Up, Down)	The order registered for the cluster	<input type="radio"/>						
	MDC (Add, Remove)	Two upper level mirror connects	<input type="radio"/>						

		registered for the cluster							
Hybrid Disk Resource Tuning Properties									
Mirror Tab									
Execute the initial mirror construction	On					0	0		
Mirror Connect Timeout	20 seconds					0	0		
Request Queue Maximum Size	2048 KB					0	0		
Mode	Synchronous					0	0		
Kernel Queue Size	2048 KB					0	0		
Application Queue Size	2048 KB					0	0		
Thread Timeout	30 seconds					0	0		
Communication Band Limit	Unlimited					0	0		
History Files Store Folder	-					0	0		
History Files Size Limit	Unlimited					0	0		
Compress Data When Recovering	Off					0	0		
VM Resource Properties									
Dependency Tab									
Follow the default dependence	On • disk resource • hybrid disk resource • mirror disk resource • NAS resource					0	0		
Dependent Resources (Add, Remove)	-					0	0		
Recovery Operation Tab									
Retry Count at Activation Failure	5 times					0			
Failover Target Server	Stable server					0			
Failover Threshold	Set as much as the number of the servers					0			
Specify the count	-					0			
Final Action at Activation Failure	No Operation (Not activate next resource):					0			
Execute script before final action	Off								0
Retry Count at Deactivation Failure	0 times					0			
Final Action at Deactivation Failure	Stop cluster service and shut down the OS					0			
Execute script before final action	Off								0
Details Tab									
VM Type	Hyper-V						0		
VM Name	-						0		
VM Path	-						0		
VM Resource Tuning Properties									
Parameter Tab									
Request Timeout	180 seconds					0			
Virtual Machine Start Waiting Time	0 seconds					0			
Virtual Machine Stop Waiting Time	60 seconds					0			
Dynamic DNS Resource Properties									
Dependency Tab									
Follow the default dependence	On • Floating IP resource • Virtual IP resource •AWS elastic ip resource •AWS virtual ip resource •Azure probe port resource					0	0		
Dependent Resources (Add, Remove)	-					0	0		
Recovery Operation Tab									
Retry Count at Activation Failure	5 times					0			
Failover Target Server	Stable server					0			
Failover Threshold	0 times					0			
Specify the count	-					0			
Final Action at Activation Failure	No operation (Do not activate the next resource.)					0			
Execute script before final action	Off								0

Retry Count at Deactivation Failure	0 times			<input type="radio"/>			
Final Action at Deactivation Failure	Stop the cluster service and shut down the OS.			<input type="radio"/>			
Execute script before final action	Off						<input type="radio"/>
Details Tab							
Virtual Host Name	-				<input type="radio"/>		
IP Address	-				<input type="radio"/>		
DDNS Server	-				<input type="radio"/>		
Port Number	53				<input type="radio"/>		
Cache TTL	0 seconds				<input type="radio"/>		
Execute Dynamic Update Periodically	On				<input type="radio"/>		
Update Interval	60 minutes				<input type="radio"/>		
Delete the Registered IP Address	Off				<input type="radio"/>		
Kerberos Authentication	Off				<input type="radio"/>		
AWS elastic ip Resource Properties							
Dependence Tab							
Follow the default dependence	On (No default dependence)				<input type="radio"/>	<input type="radio"/>	
Dependent Resources (Add, Remove)	-				<input type="radio"/>	<input type="radio"/>	
Recovery Operation Tab							
Retry Count at Activation Failure	5 times				<input type="radio"/>		
Failover Target Server	Stable operation server				<input type="radio"/>		
Failover Threshold	Set as much as the number of the servers				<input type="radio"/>		
Specify the count	-				<input type="radio"/>		
Final Action at Activation Failure	No Operation (Not activate next resources)				<input type="radio"/>		
Execute Script before Final Action	Off						<input type="radio"/>
Retry Count at Deactivation Failure	zero				<input type="radio"/>		
Final Action at Deactivation Failure	Stop the cluster daemon and shut down OS.				<input type="radio"/>		
Execute Script before Final Action	Off						<input type="radio"/>
Details Tab							
EIP ALLOCATION ID	-					<input type="radio"/>	
ENI ID	-					<input type="radio"/>	
AWS elastic ip Resource Tuning Properties							
Parameter Tab							
AWS CLI Timeout	100 seconds					<input type="radio"/>	
AWS virtual ip Resource Properties							
Dependence Tab							
Follow the default dependence	On (No default dependence)				<input type="radio"/>	<input type="radio"/>	
Dependent Resources (Add, Remove)	-				<input type="radio"/>	<input type="radio"/>	
Recovery Operation Tab							
Retry Count at Activation Failure	5 times				<input type="radio"/>		
Failover Target Server	Stable operation server				<input type="radio"/>		
Failover Threshold	Set as much as the number of the servers				<input type="radio"/>		
Specify the count	-				<input type="radio"/>		
Final Action at Activation Failure	No Operation (Not activate next resources)				<input type="radio"/>		
Execute Script before Final Action	Off						<input type="radio"/>
Retry Count at Deactivation Failure	zero				<input type="radio"/>		
Final Action at Deactivation Failure	Stop the cluster service and shut down OS.				<input type="radio"/>		
Execute Script before Final Action	Off						<input type="radio"/>
Details Tab							
IP address	-					<input type="radio"/>	
VPC ID	-					<input type="radio"/>	
ENI ID	-					<input type="radio"/>	
AWS virtual ip Resource Tuning Properties							
Parameter Tab							

Disk RW Monitor Resource Properties							
Monitor(common) Tab							
Interval	30 seconds			<input type="radio"/>			
Timeout	300 seconds			<input type="radio"/>			
Do Not Retry at Timeout Occurrence	Off			<input type="radio"/>			
Do not Execute Recovery Action at Timeout Occurrence	Off			<input type="radio"/>			
Retry Count	0 time			<input type="radio"/>			
Wait Time to Start Monitoring	0 second			<input type="radio"/>			
Monitor Timing	Active			<input type="radio"/>			
Target Resource	-			<input type="radio"/>			
Error Detection Server							
Error Detection Server	All Servers			<input type="radio"/>			
Servers that can run the Group (Add, Remove)	-			<input type="radio"/>			
Monitor (special) Tab							
Fine Name	-			<input type="radio"/>			
I/O size	2000000 bytes			<input type="radio"/>			
Action on Stall	Generate an intentional stop error			<input type="radio"/>			
Action when diskfull is detected	The recovery action enabled			<input type="radio"/>			
Use Write Through Method	Disabled			<input type="radio"/>			
Recovery Action Tab							
Recovery Action	Custom settings			<input type="radio"/>			
Recovery Target	-			<input type="radio"/>			
Recovery Script Execution Count	zero			<input type="radio"/>			
Execute Script before Reactivation	Off						<input type="radio"/>
Maximum Reactivation Count	0 time (if the recovery target is other than clusters)			<input type="radio"/>			
Execute Script before Failover	Off						<input type="radio"/>
Execute migration before failing over	Off			<input type="radio"/>			
Failover Target Server	Stable Server			<input type="radio"/>			
Maximum Failover Count	Set as much as the number of the servers			<input type="radio"/>			
Set Number	-			<input type="radio"/>			
Execute Script before Final Action	Off						<input type="radio"/>
Final Action	No Operation			<input type="radio"/>			
Floating IP Monitor Resource Properties							
Monitor(common)Tab							
Interval	60 seconds			<input type="radio"/>			
Timeout	60 seconds			<input type="radio"/>			
Do Not Retry at Timeout Occurrence	Off			<input type="radio"/>			
Do not Execute Recovery Action at Timeout Occurrence	Off			<input type="radio"/>			
Retry Count	1 time			<input type="radio"/>			
Wait Time to Start Monitoring	0 second			<input type="radio"/>			
Monitor Timing	Active			<input type="radio"/>			
Target Resource	-			<input type="radio"/>			
Error Detection Server							
Error Detection Server	All Servers			<input type="radio"/>			
Servers that can run the Group (Add, Remove)	-			<input type="radio"/>			
Monitor (special) Tab							
Monitor NIC Link Up/Down	Off						<input type="radio"/>
Recovery Action Tab							
Recovery Action	Custom settings			<input type="radio"/>			
Recovery Target	-			<input type="radio"/>			
Recovery Script Execution Count	zero			<input type="radio"/>			
Execute Script before Reactivation	Off						<input type="radio"/>
Maximum Reactivation Count	3 times (if the recovery target is other than clusters)			<input type="radio"/>			
Execute Script before Failover	Off						<input type="radio"/>

Execute migration before failing over	Off				0			
Failover Target Server	Stable Server				0			
Maximum Failover Count	Set as much as the number of the servers				0			
Set Number	-				0			
Execute Script before Final Action	Off							0
Final Action	No operation				0			
IP Monitor Resource Properties								
Monitor (common) tab								
Interval	60 seconds				0			
Timeout	60 seconds				0			
Do Not Retry at Timeout Occurrence	Off				0			
Do not Execute Recovery Action at Timeout Occurrence	Off				0			
Retry Count	1 time				0			
Wait Time to Start Monitoring	0 second				0			
Monitor Timing	Always				0			
Target Resource	-				0			
Error Detection Server								
Error Detection Server	All Servers				0			
Servers that can run the Group (Add, Remove)	-				0			
Monitor (special) Tab								
IP Address (Add, Remove, Edit)	-							0
ping Timeout	5000 milliseconds							0
Recovery Action Tab								
Recovery Action	Custom settings				0			
Recovery Target	-				0			
Recovery Script Execution Count	zero				0			
Execute Script before Reactivation	Off							0
Maximum Reactivation Count	3 times (if the recovery target is other than clusters)				0			
Execute Script before Failover	Off							0
Execute migration before failing over	Off				0			
Failover Target Count	Stable Server				0			
Maximum Failover Count	Set as much as the number of the servers				0			
Set Number	-				0			
Execute Script before Final Action	Off							0
Final Action	No operation				0			
Mirror Connect Monitor Resource Properties								
Monitor (common) Tab								
Interval	60 seconds				0			
Timeout	20 seconds				0			
Do Not Retry at Timeout Occurrence	Off				0			
Do not Execute Recovery Action at Timeout Occurrence	Off				0			
Retry Count	0 time				0			
Wait Time to Start Monitoring	0 second				0			
Monitor Timing	Always (fixed)				0			
Target Resource	-				0			
Error Detection Server								
Error Detection Server	All Servers				0			
Servers that can run the Group (Add, Remove)	-				0			
Monitor (special) Tab								
Mirror Disk Resource	-				0			
Recovery Action Tab								
Recovery Action	Execute only the final action				0			
Recovery Target	-				0			
Recovery Script Execution Count	zero				0			
Execute Script before Reactivation	Off							0

Recovery Script Execution Count	zero				<input type="radio"/>			
Execute Script before Reactivation	Off							<input type="radio"/>
Maximum Reactivation Count	3 times				<input type="radio"/>			
Execute Script before Failover	Off							<input type="radio"/>
Execute migration before failing over	Off				<input type="radio"/>			
Failover Target Server	Stable Server				<input type="radio"/>			
Maximum Failover Count	Set as much as the number of the servers				<input type="radio"/>			
Set Number	-				<input type="radio"/>			
Execute Script before Final Action	Off							<input type="radio"/>
Final Action	No operation				<input type="radio"/>			
Disk TUR Monitor Resource Properties								
Monitor (common) Tab								
Interval	30 seconds				<input type="radio"/>			
Timeout	300 seconds				<input type="radio"/>			
Do Not Retry at Timeout Occurrence	Off				<input type="radio"/>			
Do not Execute Recovery Action at Timeout Occurrence	Off				<input type="radio"/>			
Retry Count	1 time				<input type="radio"/>			
Wait Time to Start Monitoring	0 second				<input type="radio"/>			
Monitor Timing	Always				<input type="radio"/>			
Target Resource	-				<input type="radio"/>			
Error Detection Server								
Error Detection Server	All Servers				<input type="radio"/>			
Servers that can run the Group (Add, Remove)	-				<input type="radio"/>			
Monitor (special) Tab								
Disk Resource	-				<input type="radio"/>			
Recovery Action Tab								
Recovery Action	Custom settings				<input type="radio"/>			
Recovery Target	-				<input type="radio"/>			
Recovery Script Execution Count	zero				<input type="radio"/>			
Execute Script before Reactivation	Off							<input type="radio"/>
Maximum Reactivation Count	0 time				<input type="radio"/>			
Execute Script before Failover	Off							<input type="radio"/>
Execute migration before failing over	Off				<input type="radio"/>			
Failover Target Server	Stable Server				<input type="radio"/>			
Maximum Failover Count	Set as much as the number of the servers				<input type="radio"/>			
Set Number	-				<input type="radio"/>			
Execute Script before Final Action	Off							<input type="radio"/>
Final Action	No operation				<input type="radio"/>			
Service Monitor Resource Properties								
Monitor (common) Tab								
Interval	60 seconds				<input type="radio"/>			
Timeout	60 seconds				<input type="radio"/>			
Do Not Retry at Timeout Occurrence	Off				<input type="radio"/>			
Do not Execute Recovery Action at Timeout Occurrence	Off				<input type="radio"/>			
Retry Count	1 time				<input type="radio"/>			
Wait Time to Start Monitoring	0 second				<input type="radio"/>			
Monitor Timing	Active (fixed)				<input type="radio"/>			
Target Resource	-				<input type="radio"/>			
Error Detection Server								
Error Detection Server	All Servers				<input type="radio"/>			
Servers that can run the Group (Add, Remove)	-				<input type="radio"/>			
Recovery Action Tab								
Recovery Action	Custom settings				<input type="radio"/>			
Recovery Target	-				<input type="radio"/>			
Recovery Script Execution Count	zero				<input type="radio"/>			
Execute Script before Reactivation	Off							<input type="radio"/>

Failover Target Server	Stable Server			<input type="radio"/>			
Maximum Failover Count	0 time			<input type="radio"/>			
Set Number	-			<input type="radio"/>			
Execute Script before Final Action	Off						<input type="radio"/>
Final Action	Stop the cluster and shut down the OS			<input type="radio"/>			
Virtual IP Monitor Resource Properties							
Monitor (common) Tab							
Interval	60 seconds			<input type="radio"/>			
Timeout	60 seconds			<input type="radio"/>			
Retry Count	1 time			<input type="radio"/>			
Wait Time to Start Monitoring	0 second			<input type="radio"/>			
Monitor Timing	Active (fixed)			<input type="radio"/>			
Target Resource	-			<input type="radio"/>			
Error Detection Server							
Error Detection Server	All Servers			<input type="radio"/>			
Servers that can run the Group (Add, Remove)	-			<input type="radio"/>			
Recovery Action Tab							
Recovery Action	Custom settings			<input type="radio"/>			
Recovery Target	-			<input type="radio"/>			
Recovery Script Execution Count	zero			<input type="radio"/>			
Execute Script before Reactivation	Off						<input type="radio"/>
Maximum Failover Count	3 times			<input type="radio"/>			
Execute Script before Failover	Off						<input type="radio"/>
Execute migration before failing over	Off			<input type="radio"/>			
Failover Target Server	Stable Server			<input type="radio"/>			
Maximum Failover Count	Set as much as the number of the servers			<input type="radio"/>			
Set Number	-			<input type="radio"/>			
Execute Script before Final Action	Off						<input type="radio"/>
Final Action	No operation			<input type="radio"/>			
CIFS Monitor Resource Properties							
Monitor (common) Tab							
Interval	60 seconds			<input type="radio"/>			
Timeout	60 seconds			<input type="radio"/>			
Do Not Retry at Timeout Occurrence	Off			<input type="radio"/>			
Do not Execute Recovery Action at Timeout Occurrence	Off			<input type="radio"/>			
Retry Count	1 time			<input type="radio"/>			
Wait Time to Start Monitoring	0 second			<input type="radio"/>			
Monitor Timing	Active (fixed)			<input type="radio"/>			
Target Resource	-			<input type="radio"/>			
Error Detection Server							
Error Detection Server	All Servers			<input type="radio"/>			
Servers that can run the Group (Add, Remove)	-			<input type="radio"/>			
Monitor (special) Tab							
Access Check	Disable			<input type="radio"/>			
Path	-			<input type="radio"/>			
Check	Read			<input type="radio"/>			
Recovery Action Tab							
Recovery Action	Custom settings			<input type="radio"/>			
Recovery Target	-			<input type="radio"/>			
Recovery Script Execution Count	zero			<input type="radio"/>			
Execute Script before Reactivation	Off						<input type="radio"/>
Maximum Reactivation Count	3 times			<input type="radio"/>			
Execute Script before Failover	Off						<input type="radio"/>
Execute migration before failing over	Off			<input type="radio"/>			
Failover Target Server	Stable server			<input type="radio"/>			
Maximum Failover Count	Set as much as the number of the servers			<input type="radio"/>			

Maximum Failover Count	Set as much as the number of the servers				0			
Set Number	-				0			
Execute Script before Final Action	Off							0
Final Action	No operation				0			
Message Receive Monitor Resource Properties								
Monitor (common) Tab								
Interval	10 seconds				0			
Timeout	30 seconds				0			
Retry Count	0 time				0			
Wait Time to Start Monitoring	0 second				0			
Monitor Timing	Always				0			
Target Resource	-				0			
Error Detection Server								
Error Detection Server	All Servers				0			
Servers that can run the Group (Add, Remove)	-				0			
Monitor (special) Tab								
Category	-							0
Keyword	-							0
Recovery Action Tab								
Recovery Action	Executing failover to the recovery target				0			
Recovery Target	-				0			
Execute migration before failing over	Off				0			
Failover Target Server	Stable Server				0			
Execute Failover to outside the Server Group	Off				0			
Final Action	No operation				0			
Execute Script before Final Action	Off							0
VM Monitor Resource Properties								
Monitor (common) Tab								
Interval	60 seconds				0			
Timeout	60 seconds				0			
Retry Count	1 time				0			
Wait Time to Start Monitoring	0 second				0			
Monitor Timing	Active (fixed)				0			
Target Resource	-				0			
Error Detection Server								
Error Detection Server	All Servers				0			
Servers that can run the Group (Add, Remove)	-				0			
Monitor (special) Tab								
Virtual Machine Resource	-				0			
Recovery Action Tab								
Recovery Action	Custom settings				0			
Recovery Target	-				0			
Recovery Script Execution Count	zero				0			
Execute Script before Reactivation	Off							0
Maximum Reactivation Count	3 times				0			
Execute Script before Failover	Off							0
Execute migration before failing over	Off				0			
Failover Target Server	Stable Server				0			
Maximum Failover Count	Set as much as the number of the servers				0			
Set Number	-				0			
Execute Script before Final Action	Off							0
Final Action	No operation				0			
DB2 Monitor Resource Properties								
Monitor (common) Tab								
Interval	60 seconds				0			
Timeout	120 seconds				0			
Do Not Retry at Timeout Occurrence	Off				0			

Do not Execute Recovery Action at Timeout Occurrence	Off				<input type="radio"/>			
Retry Count	2 times				<input type="radio"/>			
Wait Time to Start Monitoring	0 second				<input type="radio"/>			
Monitor Timing	Active (fixed)				<input type="radio"/>			
Target Resource	-				<input type="radio"/>			
Error Detection Server								
Error Detection Server	All Servers				<input type="radio"/>			
Servers that can run the Group (Add, Remove)	-				<input type="radio"/>			
Monitor (special) Tab								
Monitor Level	Level 2 (monitored by update/select)				<input type="radio"/>			
Database Name	-				<input type="radio"/>			
Instance Name	DB2				<input type="radio"/>			
User Name	db2admin				<input type="radio"/>			
Password	-				<input type="radio"/>			
Monitor Table Name	DB2WATCH				<input type="radio"/>			
Recovery Action Tab								
Recovery Action	Custom settings				<input type="radio"/>			
Recovery Target	-				<input type="radio"/>			
Recovery Script Execution Count	zero				<input type="radio"/>			
Execute Script before Reactivation	Off				<input type="radio"/>			<input type="radio"/>
Maximum Reactivation Count	0 time				<input type="radio"/>			
Execute Script before Failover	Off				<input type="radio"/>			<input type="radio"/>
Execute migration before failing over	Off				<input type="radio"/>			
Failover Target Server	Stable Server				<input type="radio"/>			
Maximum Failover Count	Set as much as the number of the servers				<input type="radio"/>			
Set Number	-				<input type="radio"/>			
Execute Script before Final Action	Off				<input type="radio"/>			<input type="radio"/>
Final Action	No operation				<input type="radio"/>			
FTP Monitor Resource Properties								
Monitor (common) Tab								
Interval	30 seconds				<input type="radio"/>			
Timeout	60 seconds				<input type="radio"/>			
Do Not Retry at Timeout Occurrence	Off				<input type="radio"/>			
Do not Execute Recovery Action at Timeout Occurrence	Off				<input type="radio"/>			
Retry Count	3 times				<input type="radio"/>			
Wait Time to Start Monitoring	0 second				<input type="radio"/>			
Monitor Timing	Active (fixed)				<input type="radio"/>			
Target Resource	-				<input type="radio"/>			
Error Detection Server								
Error Detection Server	All Servers				<input type="radio"/>			
Servers that can run the Group (Add, Remove)	-				<input type="radio"/>			
Monitor (special) Tab								
IP Address	127.0.0.1				<input type="radio"/>			
Port Number	21				<input type="radio"/>			
User Name	-				<input type="radio"/>			
Password	-				<input type="radio"/>			
Recovery Action Tab								
Recovery Action	Custom settings				<input type="radio"/>			
Recovery Target	-				<input type="radio"/>			
Recovery Script Execution Count	zero				<input type="radio"/>			
Execute Script before Reactivation	Off				<input type="radio"/>			<input type="radio"/>
Maximum Reactivation Count	0 time				<input type="radio"/>			
Execute Script before Failover	Off				<input type="radio"/>			<input type="radio"/>
Execute migration before failing over	Off				<input type="radio"/>			
Failover Destination Server	Stable Server				<input type="radio"/>			
Maximum Failover Count	Set as much as the number of				<input type="radio"/>			

	the servers						
Set Number	-			0			
Execute Script before Final Action	Off						0
Final Action	No operation			0			
HTTP Monitor Resource Properties							
Monitor (common) Tab							
Interval	30 seconds			0			
Timeout	60 seconds			0			
Do Not Retry at Timeout Occurrence	Off			0			
Do not Execute Recovery Action at Timeout Occurrence	Off			0			
Retry Count	3 times			0			
Wait Time to Start Monitoring	0 second			0			
Monitor Timing	Active (fixed)			0			
Target Resource	-			0			
Error Detection Server							
Error Detection Server	All Servers			0			
Servers that can run the Group (Add, Remove)	-			0			
Monitor (special) Tab							
Connecting Destination	127.0.0.1			0			
Port Number	80			0			
Monitor URL	-			0			
Protocol	HTTP			0			
Recovery Action Tab							
Recovery Action	Custom settings			0			
Recovery Target	-			0			
Recovery Script Execution Count	zero			0			
Execute Script before Reactivation	Off						0
Maximum Reactivation Count	0 time			0			
Execute Script before Failover	Off						0
Execute migration before failing over	Off			0			
Failover Target Server	Stable Server			0			
Maximum Failover Count	Set as much as the number of the servers			0			
Set Number	-			0			
Execute Script before Final Action	Off						0
Final Action	No operation			0			
IMAP4 Monitor Resource Properties							
Monitor (common) Tab							
Interval	30 seconds			0			
Timeout	60 seconds			0			
Do Not Retry at Timeout Occurrence	Off			0			
Do not Execute Recovery Action at Timeout Occurrence	Off			0			
Retry Count	3 times			0			
Wait Time to Start Monitoring	0 second			0			
Monitor Timing	Active (fixed)			0			
Target Resource	-			0			
Error Detection Server							
Error Detection Server	All Servers			0			
Servers that can run the Group (Add, Remove)	-			0			
Monitor (special) Tab							
IP Address	127.0.0.1			0			
Port Number	143			0			
User Name	-			0			
Password	-			0			
Authentication Method	AUTHENTICATELOGIN			0			
Recovery Action Tab							
Recovery Action	Custom settings			0			
Recovery Target	-			0			

Recovery Script Execution Count	zero				<input type="radio"/>			
Execute Script before Reactivation	Off							<input type="radio"/>
Maximum Reactivation Count	0 time				<input type="radio"/>			
Execute Script before Failover	Off							<input type="radio"/>
Execute migration before failing over	Off				<input type="radio"/>			
Failover Target Server	Stable Server				<input type="radio"/>			
Maximum Failover Count	Set as much as the number of the servers				<input type="radio"/>			
Set Number	-				<input type="radio"/>			
Execute Script before Final Action	Off							<input type="radio"/>
Final Action	No operation				<input type="radio"/>			
ODBC Monitor Resource Properties								
Monitor (common) Tab								
Interval	60 seconds				<input type="radio"/>			
Timeout	120 seconds				<input type="radio"/>			
Do Not Retry at Timeout Occurrence	Off				<input type="radio"/>			
Do not Execute Recovery Action at Timeout Occurrence	Off				<input type="radio"/>			
Retry Count	2 times				<input type="radio"/>			
Wait Time to Start Monitoring	0 second				<input type="radio"/>			
Monitor Timing	Active (fixed)				<input type="radio"/>			
Target Resource	-				<input type="radio"/>			
Error Detection Server								
Error Detection Server	All Servers				<input type="radio"/>			
Servers that can run the Group (Add, Remove)	-				<input type="radio"/>			
Monitor (special) Tab								
Monitor Level	Level 2 (monitored by update/select)				<input type="radio"/>			
Data Source Name	-				<input type="radio"/>			
User Name	-				<input type="radio"/>			
Password	-				<input type="radio"/>			
Monitor Table Name	ODBCWATCH				<input type="radio"/>			
Recovery Action Tab								
Recovery Action	Custom settings				<input type="radio"/>			
Recovery Target	-				<input type="radio"/>			
Recovery Script Execution Count	zero				<input type="radio"/>			
Execute Script before Reactivation	Off							<input type="radio"/>
Maximum Reactivation Count	0 time				<input type="radio"/>			
Execute Script before Failover	Off							<input type="radio"/>
Execute migration before failing over	Off				<input type="radio"/>			
Failover Target Server	Stable Server				<input type="radio"/>			
Maximum Failover Count	Set a value equal to the number of servers				<input type="radio"/>			
Set Number	-				<input type="radio"/>			
Execute Script before Final Action	Off							<input type="radio"/>
Final Action	No operation				<input type="radio"/>			
Oracle Monitor Resource Properties								
Monitor (common) Tab								
Interval	60 seconds				<input type="radio"/>			
Timeout	120 seconds				<input type="radio"/>			
Collect the dump file of the monitor process at timeout occurrence	Off				<input type="radio"/>			
Do Not Retry at Timeout Occurrence	Off				<input type="radio"/>			
Do not Execute Recovery Action at Timeout Occurrence	Off				<input type="radio"/>			
Retry Count	2 times				<input type="radio"/>			
Wait Time to Start Monitoring	0 second				<input type="radio"/>			
Monitor Timing	Active (fixed)				<input type="radio"/>			
Target Resource	-				<input type="radio"/>			
Error Detection Server								
Error Detection Server	All Servers				<input type="radio"/>			

Recovery Action Tab							
Recovery Action	Custom settings						
Recovery Target	-						
Recovery Script Execution Count	zero						
Execute Script before Reactivation	Off						
Maximum Reactivation Count	3 times						
Execute Script before Failover	Off						
Execute migration before failing over	Off						
Maximum Failover Count	0						
Execute Script before Final Action	Off						
Final Action	No operation						
System Monitor Resource Properties							
Monitor (common) Tab							
Interval	30 seconds						
Timeout	60 seconds						
Retry Count	0 time						
Wait Time to Start Monitoring	0 second						
Monitor Timing	Always						
Target Resource	-						
Error Detection Server							
Error Detection Server	All Servers						
Servers that can run the Group (Add, Remove)	-						
Monitor (special) Tab							
SystemResourceAgent System Settings							
Monitoring CPU usage	ON						
CPU Usage	90%						
Duration Time	60 minutes						
Monitoring total usage of memory	ON						
Total memory usage	90%						
Duration Time	60 minutes						
Monitoring total usage of virtual memory	ON						
Total virtual memory usage	90%						
Duration Time	60 minutes						
SystemResourceAgent Process Settings							
CPU utilization has been 90% or more for 24 hours or more	ON						
Memory usage has increased, including an increase of 10% or more from first monitoring point after 24 hours or more had passed	ON						
The maximum number of open files has been updated over 1440 times	OFF						
Number of running threads has been increasing for over 24 hours	ON						
100 or more processes of the same name exist	ON						
SystemResourceAgent Disk Settings							
Logical drive							
Utilization rate	ON						
Warning level	90%						
Notice level	80 %						
Duration	1440 minutes						
Free space	ON						
Warning level	500 MB						
Notice level	1000 MB						
Duration	1440 minutes						
Recovery Action Tab							
Recovery Action	Custom settings						
Recovery Target	-						

Recovery Script Execution Count	zero			<input type="radio"/>			
Execute Script before Reactivation	Off						<input type="radio"/>
Maximum Reactivation Count	zero			<input type="radio"/>			
Execute Script before Failover	Off						<input type="radio"/>
Execute migration before failing over	Off			<input type="radio"/>			
Failover Target Server	Stable server			<input type="radio"/>			
Maximum Failover Count	Set as much as the number of the servers			<input type="radio"/>			
Specify the count	-			<input type="radio"/>			
Final Action	No Operation			<input type="radio"/>			
Execute Script before Final Action	Off						<input type="radio"/>
Dynamic DNS Monitor Resource Properties							
Monitor(common) Tab							
Interval	60 seconds			<input type="radio"/>			
Timeout	120 seconds			<input type="radio"/>			
Do Not Retry at Timeout Occurrence	Off			<input type="radio"/>			
Do not Execute Recovery Action at Timeout Occurrence	Off			<input type="radio"/>			
Retry Count	1 time			<input type="radio"/>			
Wait Time to Start Monitoring	0 seconds			<input type="radio"/>			
Monitoring Timing	When active (fixed)			<input type="radio"/>			
Target Resource	-			<input type="radio"/>			
Error Detection Server							
Error Detection Server	All Servers			<input type="radio"/>			
Servers that can run the Group (Add, Remove)	-			<input type="radio"/>			
Monitor (special) Tab							
Check Name Resolution	On			<input type="radio"/>			
Recovery Action Tab							
Recovery Action	Custom settings			<input type="radio"/>			
Recovery Target	-			<input type="radio"/>			
Recovery Script Execution Count	0 times			<input type="radio"/>			
Execute Script before Reactivation	Off						<input type="radio"/>
Maximum Reactivation Count	3 times			<input type="radio"/>			
Execute Script before Failover	Off						<input type="radio"/>
Run Migration Before Run Failover	Off			<input type="radio"/>			
Failover Target Server	Stable server			<input type="radio"/>			
Maximum Failover Count	Set as much as the number of servers.			<input type="radio"/>			
Specify the count	-			<input type="radio"/>			
Execute Script before Final Action	Off						<input type="radio"/>
Final Action	No operation			<input type="radio"/>			
Process Name Monitor Resource Properties							
Monitor(common) Tab							
Interval	5 seconds			<input type="radio"/>			
Timeout	60 seconds			<input type="radio"/>			
Do Not Retry at Timeout Occurrence	Off			<input type="radio"/>			
Do not Execute Recovery Action at Timeout Occurrence	Off			<input type="radio"/>			
Retry Count	0 time			<input type="radio"/>			
Wait Time to Start Monitoring	0 seconds			<input type="radio"/>			
Monitoring Timing	Always			<input type="radio"/>			
Target Resource	-			<input type="radio"/>			
Error Detection Server							
Error Detection Server	All Servers			<input type="radio"/>			
Servers that can run the Group (Add, Remove)	-			<input type="radio"/>			
Monitor (special) Tab							
Process name	-			<input type="radio"/>			

Specify the count	-				<input type="radio"/>			
Execute Script before Final Action	Off							<input type="radio"/>
Final Action	No Operation				<input type="radio"/>			
AWS virtual ip Monitor Resource Properties								
Monitor(common) Tab								
Interval	60 seconds				<input type="radio"/>			
Timeout	100 seconds				<input type="radio"/>			
Do Not Retry at Timeout Occurrence	Off				<input type="radio"/>			
Do not Execute Recovery Action at Timeout Occurrence	Off				<input type="radio"/>			
Retry Count	1 time				<input type="radio"/>			
Wait Time to Start Monitoring	0 seconds				<input type="radio"/>			
Monitor Timing	Active (fixed)				<input type="radio"/>			
Target Resource	awsvip				<input type="radio"/>			
Error Detection Server								
Error Detection Server	All Servers				<input type="radio"/>			
Servers that can run the Group (Add, Remove)	-				<input type="radio"/>			
Monitor (special) Tab								
Action when AWS CLI command failed to receive response	Disable recovery action(Display warning)				<input type="radio"/>			
Recovery Action Tab								
Recovery Action	Custom settings				<input type="radio"/>			
Recovery Target	-				<input type="radio"/>			
Recovery Script Execution Count	zero				<input type="radio"/>			
Execute Script before Reactivation	Off							<input type="radio"/>
Maximum Reactivation Count	3 times				<input type="radio"/>			
Failover Target Server	Off							<input type="radio"/>
Execute migration before failing over	Off				<input type="radio"/>			
Failover Target Server	Stable server				<input type="radio"/>			
Maximum Failover Count	Set as much as the number of the servers				<input type="radio"/>			
Specify the count	-				<input type="radio"/>			
Execute Script before Final Action	Off							<input type="radio"/>
Final Action	No Operation				<input type="radio"/>			
AWS AZ Monitor Resource Properties								
Monitor(common) Tab								
Interval	60 seconds				<input type="radio"/>			
Timeout	100 seconds				<input type="radio"/>			
Do Not Retry at Timeout Occurrence	Off				<input type="radio"/>			
Do not Execute Recovery Action at Timeout Occurrence	Off				<input type="radio"/>			
Retry Count	1 time				<input type="radio"/>			
Wait Time to Start Monitoring	0 seconds				<input type="radio"/>			
Monitor Timing	Always (fixed)				<input type="radio"/>			
Target Resource	-				<input type="radio"/>			
Error Detection Server								
Error Detection Server	All Servers				<input type="radio"/>			
Servers that can run the Group (Add, Remove)	-				<input type="radio"/>			
Monitor (special) Tab								
Availability Zone	-				<input type="radio"/>			
Action when AWS CLI command failed to receive response	Disable recovery action(Display warning)				<input type="radio"/>			
Recovery Action Tab								
Recovery Action	Custom settings				<input type="radio"/>			
Recovery Target	-				<input type="radio"/>			
Recovery Script Execution Count	zero				<input type="radio"/>			
Execute Script before Reactivation	Off							<input type="radio"/>

Recovery Action	Custom settings			<input type="radio"/>			
Recovery Target	-			<input type="radio"/>			
Recovery Script Execution Count	zero			<input type="radio"/>			
Execute Script before Reactivation	Off						<input type="radio"/>
Maximum Reactivation Count	3 times			<input type="radio"/>			
Execute Script before Failover	Off						<input type="radio"/>
Execute migration before failing over	Off			<input type="radio"/>			
Failover Target Server	Stable Server			<input type="radio"/>			
Maximum Failover Count	Set as much as the number of the servers			<input type="radio"/>			
Specify the count	-			<input type="radio"/>			
Execute Script before Final Action	Off						<input type="radio"/>
Final Action	No Operation			<input type="radio"/>			

Upper limits of registration

	Builder version	You can register up to
Cluster	3.0.0-1 or later	1
Server	3.0.0-1 or later	32
Server Group	3.0.0-1 or later	9
Group	Earlier than 3.1.0-1	64
	3.1.0-1 or later	128
Group resource (Per one group)	Earlier than 3.1.0-1	256
	3.1.0-1 or later	512
Monitor resource	3.0.0-1 or later	384
Heartbeat resource	3.0.0-1 or later	16
BMC heartbeat resource	3.1.0-3 or later	1
Network Partition Resolution Resource	3.0.0-1 or later	64
Mirror disk resources and hybrid disk resources (Per cluster) in total	3.0.0-1 or later	8
Mirror Disk Connect	3.0.0-1 or later	16
System monitor resource	3.1.0-1 or later	1

Chapter 3 EXPRESSCLUSTER command reference

This chapter describes commands that are used on EXPRESSCLUSTER.

This chapter covers:

• Operating the cluster from the command line	256
• EXPRESSCLUSTER commands	256
• Displaying the cluster status (clpstat command)	259
• Operating the cluster (clpcl command).....	345
• Shutting down a specified server (clpdown command).....	349
• Shutting down the entire cluster (clpstdn command)	350
• Operating groups (clpgrp command).....	351
• Collecting logs (clplogcc command)	357
• Creating a cluster and backing up configuration data (clpcfctrl command)	364
• Adjusting time-out temporarily (clptoratio command).....	372
• Modifying the log level and size (clplogcf command)	375
• Registering the license (clplcncs command)	386
• Mirror-related commands	387
• Displaying the mirror status (clpmdstat command).....	387
• Operating mirror disk resource (clpmdctrl command)	395
• Tuning partition size (clpvolsz command)	400
• Controlling disk access (clpvolctrl command)	402
• Operating snapshot backup of hybrid disk resource (clphdsnapshot command)	404
• Displaying the hybrid disk status (clphdstat command)	407
• Operating hybrid disk resource (clphdctrl command)	414
• Outputting messages (clplogcmd command).....	419
• Controlling monitor resources (clpmonctrl command)	421
• Controlling group resources (clprsc command).....	429
• Switching off network warning light (clplamp command).....	434
• Controlling CPU frequency (clpcpufreq command).....	435
• Controlling chassis identify lamp (clpledctrl command).....	437
• Processing inter-cluster linkage (clptrnreq command)	439
• Requesting processing to cluster servers (clprexec command)	442
• Changing BMC information (clpbmccnf command).....	446
• Configuring shutdown hook (clphookctrl command).....	448
• Controlling cluster activation synchronization wait processing (clpbwctrl command).....	450
• Controlling reboot count (clpregctrl command)	451
• Estimating the amount of resource usage (clpprer command).....	453
• Checking the process health (clphealthchk command).....	458

Operating the cluster from the command line

EXPRESSCLUSTER provides various commands to operate a cluster by the command prompt. These commands are useful for things like constructing a cluster or when you cannot use the WebManager. You can perform greater number of operations using the command line than WebManager.

Note:

When you have configured a group resource (examples: disk resource and application resource) as a recovery target in the settings of error detection by a monitor resource, and the monitor resource detects an error, do not perform the following actions by commands related to the actions or by the WebManager while recovery (reactivation -> failover -> final action) is ongoing.

- ◆ terminate/suspend the cluster
- ◆ start/terminate/migrate a group

If you perform the actions mentioned above against the cluster while the recovery caused by detection of an error by a monitor resource is ongoing, other group resources of that group may not terminate. However, you can perform these actions as long as the final action has been executed, even if a monitor resource detected an error.

EXPRESSCLUSTER commands

Commands for configuring a cluster		
Command	Description	Page
clpcfctrl.exe	Distributes configuration data created by the Builder to servers. Backs up the cluster configuration data to be used by the Builder.	364
clplcncsc.exe	Registers the product version or trial version license of this product.	386
Commands for displaying status		
Command	Description	Page
clpstat.exe	Displays the cluster status and configuration information.	259
clphealthchk.exe	Check the process health.	458
Commands for cluster operation		
Command	Description	Page
clpcl.exe	Starts, stops, suspends, or resumes the EXPRESSCLUSTER service.	345
clpdown.exe	Stops the EXPRESSCLUSTER service and shuts down the server.	349
clpstdn.exe	Stops the EXPRESSCLUSTER service across the whole cluster and shuts down all servers.	350
clpgrp.exe	Starts, stops, or moves groups. This command also migrates the virtual machine.	351
clptoratio.exe	Extends or displays the various time-out values of all servers in the cluster.	372
clpmonctrl.exe	Controls monitor resources.	421

clprsc.exe	Stops or resumes group resources	429
clpcpufreq.exe	Controls CPU frequency	435
clpledctrl.exe	Controls Chassis Identify	437
clptrnreq.exe	Requests the server to execute a process	439
clprexec.exe	Requests that an EXPRESSCLUSTER server execute a process from external monitoring.	442
clpbmccnf.exe	Changes the information on BMC user name and password	446
clphookctrl.exe	Configures the shutdown hook function	448
clpbwctrl.exe	Controls the cluster activation synchronization wait processing.	450
clpregctrl.exe	Displays and/or initializes reboot count on a single server	451
Log-related commands		
Command	Description	Page
clplogcc.exe	Collects logs and OS information.	357
clplogcf.exe	Modifies and displays a configuration of log level and the file size of log output.	375
Script-related commands		
Command	Description	Page
clplogcmd.exe	Writes texts in the script resource script to create a desired message to the output destination	419

Important:

The installation directory contains executable-format files and script files that are not listed in this guide. Do not execute these files by programs or applications other than EXPRESSCLUSTER. Any problems caused by not using EXPRESSCLUSTER will not be supported.

Mirror-related commands (when the Replicator/Replicator DR is used)		
Command	Description	Page
clpmdstat.exe	Displays a mirroring status and configuration information.	387
clpmdctrl.exe	Activates/deactivates a mirror disk resource, or recovers mirror.	395
clphdstat.exe	Displays a hybrid disk status and configuration information.	407
clphdctrl.exe	Activates/deactivates a hybrid disk resource, or recovers mirror.	414
clpvolsz.exe	Checks and adjusts the size of partitions to be mirrored.	400
clpvolctrl.exe	Accesses a volume not registered as a resource.	
clphdsnapshot.exe	Controls the access restriction or alike when snap shot backups of data partition in the hybrid disk resource are collected	404

Warning-related commands (when the Alert Service is used)		
Command	Description	Page
clplamp.exe	Lights off the network warning light.	434

System monitor-related commands (when the System Resource Agent is used)		
Command	Description	Page
clpprer.exe	Estimates the future value from the tendency of the given resource use amount data.	434

Displaying the cluster status (clpstat command)

clpstat: the `clpstat` command displays cluster status and configuration information.

Command line:

```
clpstat -s [--long] [-h <hostname>]
clpstat -g [-h <hostname>]
clpstat -m [-h <hostname>]
clpstat -n [-h <hostname>]
clpstat -p [-h <hostname>]
clpstat -i [--detail] [-h <hostname>]
clpstat --cl [--detail] [-h <hostname>]
clpstat --sv [<srvname>] [--detail] [-h <hostname>]
clpstat --hb [<hbname>] [--detail] [-h <host_name>]
clpstat --np [<npname>] [--detail] [-h <hostname>]
clpstat --svg [<svgname>] [-h <hostname>]
clpstat --grp [<grpname>] [--detail] [-h <hostname>]
clpstat --rsc [<recname>] [--detail] [-h <hostname>]
clpstat --mon [<monname>] [--detail] [-h <hostname>]
clpstat --local
```

Description This command line displays a cluster status and configuration data.

Option		
<code>-s</code>		Displays a cluster status.
	No option	
	<code>--long</code>	Displays a name of the cluster name and resource name until the end.
	<code>-g</code>	Displays a cluster group map.
	<code>-m</code>	Displays status of each monitor resource on each server.
	<code>-n</code>	Displays each heartbeat resource status on each server.
	<code>-p</code>	Displays the status of each network partition resolution on each server.
	<code>-i</code>	Displays the configuration information of the whole cluster.
	<code>--cl</code>	Displays the cluster configuration data. Displays the Mirror Agent information as well for the Replicator/Replicator DR.
	<code>--sv</code> [<i>server_name</i>]	Displays the server configuration information. By specifying the name of a server, you can display information of the specified server.
	<code>--hb</code> [<i>hb_name</i>]	Displays heartbeat resource configuration information. By specifying the name of a heartbeat resource, you can display only the information on the specified heartbeat.
	<code>--np</code> [<i>np_name</i>]	Displays the configuration information on the network partition resolution resource. By specifying the name of a network partition resolution resource, you can display only the

		information on the specified network partition resolution resource.
<code>--grp</code> <code>[group_name]</code>		Displays group configuration information. By specifying the name of a group, you can display only the information on the specified group.
<code>--svg</code> <code>[svgname]</code>		Displays server group configuration information. By specifying the name of a server group, you can display only the information on the specified server group.
<code>--rsc</code> <code>[resource_name]</code>		Displays group resource configuration information. By specifying the name of a group resource, you can display only the information on the specified group resource.
<code>--mon</code> <code>[monitor_name]</code>		Displays monitor resource configuration information. By specifying the name of a monitor resource, you can display only the information on the specified monitor resource.
<code>--detail</code>		Displays more detailed information on the setting.
<code>-h</code> <code>host_name</code>		Acquires information from the server specified with <code>host_name</code> . Acquires information from the command running server (local server) when the <code>-h</code> option is omitted.
<code>--local</code>		Displays the cluster status. This option displays the same information when <code>-s</code> option is specified or when no option is specified. However, this option displays only information of the server on which this command is executed, without communicating with other servers.

Return Value	0	Success
	251	This command was run duplicately.
	Other than the above	Failure

Remarks According to the combination of options, configuration information shows information in various forms.

Notes Run this command as a user with Administrator privileges.

The EXPRESSCLUSTER service must be activated on the server where you run this command.

When you specify the name of a server for the `-h` option, the server should be in the cluster.

When you run the `clpstat` command with the `-s` option or without any option, names such as a cluster or a resource will not be displayed halfway.

This command cannot be used to determine whether the cluster has been stopped or is suspended. If the cluster has been stopped or is suspended, check the status of the cluster in the tree view of WebManager.

Example of Execution

Examples of information displayed after running these commands are provided in the next section.

Error Messages

Message	Cause/Solution
Log in as administrator.	Log in as a user with Administrator privileges.
Invalid configuration file. Create valid cluster configuration data by using the Builder.	Create valid cluster configuration data by using the Builder.
Invalid option.	Specify a valid option.
Could not connect to the server. Check if the cluster service is active	Check if the EXPRESSCLUSTER service is operating.
Invalid server status.	Check if the EXPRESSCLUSTER service is operating.
Server is not active. Check if the cluster service is active.	Check if the EXPRESSCLUSTER service is operating.
Invalid server name. Specify a valid server name in the cluster.	Specify the valid server name in the cluster.
Invalid heartbeat resource name. Specify a valid heartbeat resource name in the cluster.	Specify the valid heart beat resource name in the cluster.
Invalid network partition resource name. Specify a valid network partition resource name in the cluster.	Specify the valid network partition resolution resource name in the cluster.
Invalid group name. Specify a valid group name in the cluster.	Specify the valid name of a group in the cluster.
Invalid group resource name. Specify a valid group resource name in the cluster.	Specify the valid name of a group resource in the cluster.
Invalid monitor resource name. Specify a valid monitor resource name in the cluster.	Specify the valid name of a monitor resource in the cluster.
Connection was lost. Check if there is a server where the cluster service is stopped in the cluster.	Check if there is any server on which the EXPRESSCLUSTER service has stopped in the cluster.
Invalid parameter.	An invalid value may be specified to command argument.
Internal communication timeout has occurred in the cluster server. If it occurs frequently, set a longer timeout.	A time-out occurred in the EXPRESSCLUSTER internal communication. If time-out keeps occurring, set the internal communication time-out longer.
Internal error. Check if memory or OS resources are sufficient.	Check if the memory or OS resource is sufficient.
The cluster is not created.	Create and apply the cluster configuration data.

Common entry examples

Displaying the status of the cluster (-s option)

The following is an example of display when you run the `clpstat` command with the `-s` option or without any option:

Example of a command entry

```
# clpstat -s
```

Example of the display after running the command

```
===== CLUSTER STATUS =====
Cluster : cluster                                -> See (1)
<server>
 *server1 .....: Online                        server1      -> See (2)
   lanhb1       : Normal                        LAN Heartbeat -> See (3)
   lanhb2       : Normal                        LAN Heartbeat -> See (3)
   pingnp1      : Normal                        ping resolution -> See (4)
 server2 .....: Online                        server2
   lanhb1       : Normal                        LAN Heartbeat
   lanhb2       : Normal                        LAN Heartbeat
   pingnp1      : Normal                        ping resolution
<group>
 ManagementGroup : Online                    Management Group ->See (5)
   current       : server1
 ManagementIP    : Online                    10.0.0.10
 failover1 .....: Online                    failover group1 ->See (6)
   current       : server1
   fip1          : Online                    10.0.0.11      ->See (7)
   md1          : Online                    I:
   script1      : Online                    script resource1
 failover2 .....: Online                    failover group2
   current       : server2
   fip2          : Online                    10.0.0.12
   md2          : Online                    J:
   script1      : Online                    script resource2
<monitor> -> See (9)
 fipw1          : Normal                    fip1          ->See (8)
 fipw2          : Normal                    fip2
 ipw1           : Normal                    ip monitor1
 mdnw1          : Normal                    md1
 mdnw2          : Normal                    md2
 mdw1           : Normal                    md1
 mdw2           : Normal                    md2
=====
```

Explanation of each item

- (1) Cluster : Cluster name
- (2) Server name : Status Server comment
 “*” indicates the server has executed this command.
- (3) Heartbeat resource name : Status Heartbeat resource comment
- (4) NP resolution resource name : Status NP resolution resource comment
- (5) Management group name : Status Management group comment
- (6) Group name : Status Group comment
 current : Server name

Shows the server to which the group belongs now.

- (7) Group Resource Name : Status Group resource comment
- (8) Monitor Resource Name : Status Monitor resource comment

If you enable dummy failure by WebManager or `clpmonctrl` command, the string “(Dummy Failure)” will be added at the end of the string “Status”.

- (9) Following strings will be added into the end of the string “<monitor>”.

If you select the check box of **Disable Recovery Action Caused by Monitor Resource Error** in **Cluster Properties**, the string “Recovery Action Disabled” will be added.

If any dummy failures occurs in the cluster, the string “Failure Verification” will be added.

Information on each status is provided in “Status Descriptions” on page 341.

Displaying a group map (-g option)

To display a group map, run the `clpstat` command with the `-g` option.

Example of a command entry

```
# clpstat -g
```

Example of the display after running the command:

```
===== GROUPMAP INFORMATION =====
Cluster : cluster                -> See (1)
 *server0 : server1              -> See (2)
  server1 : server2

-----

server0 [o] : failover1[o] failover2[o] -> See (3)
server1 [o] : failover3[o]

=====
```

Explanation of each item

- (1) Cluster : Cluster name
- (2) server n : Server name (n is the index number of a server)
 "*" indicates the server has executed this command.
- (3) server n [*server_status*] : Group Name [*status*] Group Name [*status*].
 Displays the status of groups in the n-th server.

In the example above, the groups `failover1` and `failover2` exist on `server0`, and the group `failover 3` exists on `server 3`.

- ◆ Groups that are not running are not displayed.
- ◆ Information on each status is provided in "Status Descriptions" on page 341.

Displaying the status of monitor resources (-m option)

To display the status of monitor resources, run the `clpstat` command with the `-m` option.

Example of a command entry

```
# clpstat -m
```

Example of the display after running the command:

```
===== MONITOR RESOURCE STATUS =====
Cluster : cluster          -> see (1)
*server0 : server1        -> see (2)
  server1 : server2        -> see (2)

Monitor0 [fipw1 : Normal] -> see (3)
-----
  server0 [o] : Online     -> see (4)
  server1 [o] : Offline    -> see (4)

Monitor1 [fipw2 : Normal]
-----
  server0 [o] : Offline
  server1 [o] : Online

Monitor2 [ipw1 : Normal]
-----
  server0 [o] : Online
  server1 [o] : Online

Monitor3 [mdnw1 : Normal]
-----
  server0 [o] : Online
  server1 [o] : Online

Monitor4 [mdnw2 : Normal]
-----
  server0 [o] : Online
  server1 [o] : Online
Monitor5 [mdw1 : Normal]
-----
  server0 [o] : Online
  server1 [o] : Online

Monitor6 [mdw2 : Normal]
-----
  server0 [o] : Online
  server1 [o] : Online
=====
```

- (1) Cluster : Cluster name
- (2) server n : Server name (n is the index number of a server)
“*” indicates the server has executed this command.
- (3) Monitor n [*monitor_resource_name: status*]
(n is the identification number of a monitor resource)
The status of a monitor resource gathering status information per server is displayed here.
If dummy failure occurs, the string “(Dummy Failure)” will be added at the end of the string of status.

- (4) `server n [server_status] : status`
Displays the status of each monitor resource per server.
If dummy failure occurs, the string "(Dummy Failure)" will be added at the end of the string of status.

Information on each status is provided in "Status Descriptions" on page 341.

Displaying the status of heartbeat resources (-n option)

To display the status of heartbeat resources, run `clpstat` command with the `-n` option.

Example of a command entry

```
# clpstat -n
```

Example of the display after running the command:

```
===== HEARTBEAT RESOURCE STATUS =====
Cluster : cluster          -> see (1)
*server0 : server1        -> see (2)
  server1 : server2        -> see (2)
  HB0 : lanhb1             -> see (3)
  HB1 : lanhb2             -> see (3)

[on server0 : Online] -> see (4)
      HB  0  1  -> see (5)
-----
server0: o  o  -> see (5)
server1: o  x  -> see (5)

[on server1 : Online]
HB  0  1
-----
server0 : o  x
server1 : o  o
=====
```

Explanation of each item

- (1) Cluster : Cluster name
- (2) server n : Server name (n is the index number of a server)
“*” indicates the server has executed this command.
- (3) HB n : Heartbeat resource name
(n is the identification number of a heartbeat resource)
- (4) [on server n : *status*]
Displays the status of the server whose index number is n.
- (5) HB 0 1 2 ..
server n : status status status
Displays the status of heartbeat resource on the server.
The numbers following HB are heartbeat resource identification numbers described in (3).

Detailed information on each status is provided in “Status Descriptions” on page 341.

The status of the example shown above:

The example above presents the status of all heartbeat resources seen from server0 and server1 when the kernel-mode LAN heartbeat resource that has the second-highest priority is disconnected.

Because kernel-mode LAN heartbeat resource `lanhb1` is not able to communicate from both servers, communication to server1 on server0 or communication to server0 on server1 is unavailable.

The rest of heartbeat resources on both servers are in the status allowing communications.

Displaying the status of network partition resolution resources (-p option)

Specify the `-p` option to the `clpstat` command and execute the command to display the status of the network partition resolution resources.

Example of a command entry

```
# clpstat -p
```

Example of the display after running the command:

```
===== NETWORK PARTITION RESOURCE STATUS =====
Cluster : cluster -> see (1)
*server0 : server1 -> see (2)
  server1 : server2 -> see (2)
  NP0 : disknp1 -> see (3)
  NP1 : pingnp2 -> see (3)

  [on server0 : Online] -> see (4)
    NP  0  1 -> see (5)
-----
server0: o  o  Same as above.
server1: o  o  Same as above.

  [on server1 : Online]
    NP  0  1
-----
server0 : o  o
server1 : o  o
=====
```

Explanation of each item

- (1) Cluster : Cluster name
- (2) server n : Server name (n is the index number of a server)
“*” indicates the server has executed this command.
- (3) NP n : network partition resolution resource name
(n is the identification number of a network partition resolution resource)
- (4) [on server n : *status*]
Displays the status of the server whose index number is n.
- (5) NP 0 1 2 ...
server n : status status status
Displays the status of network partition resolution resource on the server.
The numbers following NP are network partition resolution resource identification numbers described in (3).

Detailed information on each status is provided in “Status Descriptions” on page 341.

Displaying the cluster configuration data (clpstat command, --cl option)

To display the configuration data of a cluster, run the `clpstat` command with the `-i`, `--cl`, `--sv`, `--hb`, `--np`, `--svg`, `--grp`, `--rsc`, or `--mon` option. You can see more detailed information by specifying the `-detail` option. See a separate section, “Parameter details” on page 137 for details of each item of the list.

To display the cluster configuration data, run the `clpstat` command with the `--cl` option.

Example of a command entry

```
# clpstat --cl --detail
```

Example of the display after running the command:

```
===== CLUSTER INFORMATION =====
[Cluster Name: cluster] -> see (1)
  Comment : failover cluster -> see (2)
<Heartbeat I/F>
  Server Down Notification : On -> see (3)
  Cast Method : Unicast -> see (4)
<NP Resolution>
  Action at NP Occurrence : Emergency shutdown-> see (5)
<Timeout>
  Server Sync Wait Time : 300 -> see (6)
  Heartbeat Timeout : 90000 -> see (7)
  Heartbeat Interval : 3000 -> see (8)
  Server Internal Timeout : 180 -> see (9)
  Timeout Ratio : 1 -> see (10)
<Port Number>
  Server Internal Port Number : 29001 -> see (11)
  Data Transfer Port Number : 29002 -> see (12)
  Kernel Heartbeat Port Number : 29106 -> see (13)
  Client Service Port Number : 29007 -> see (14)
  WebManager HTTP Port Number : 29003 -> see (15)
  Alert Sync Port Number : 29003 -> see (16)
  Disk Agent Port Number : 29004 -> see (17)
  Mirror Driver Port Number : 29005 -> see (18)
<Monitor>
  Collect System Resource Information : off -> see (19)
<Recovery>
  Max Reboot Count : 0 -> see (20)
  Max Reboot Count Reset Time : 0 -> see (21)
  Use Forced Stop : Off -> see (22)
  Forced Stop Action : BMC Power Off -> see (23)
  Forced Stop Timeout(sec) : 3 -> see (24)
  Execute Script for Forced Stop : Off -> see (25)
  Action When the Cluster Service Process Is Failure : Shut down the OS -> see (26)
  Recovery Action for HA Agents:Max Restart Count : 3 -> see (27)
  Recovery Action for HA Agents:Recovery Action over Max Restart Count : No operation -> see (28)
  Disable Recovery Action Caused by Monitor Resource Failure : Off -> see (29)
```

```

Action at Group Resource Activation or Deactivation Stall
      : Emergency shutdown-> see (30)
Restrain the shutdown action if only one server is alive
<When active group resource abnormality detected>
      : Off -> see (31)
Restrain the shutdown action if only one server is alive
<When deactive group resource abnormality detected>
      : Off -> see (32)
Restrain the shutdown action if only one server is alive
<When monitoring resource abnormality detected>
      : Off -> see (33)
<Alert Service>
E-mail Address : -> see (34)
Use Network Warning Light : Off -> see (35)
Use Chassis Identify : Off -> see (36)
Enable Alert Setting : Off -> see (37)
<Delay Warning>
Heartbeat Delay Warning : 80 -> see (38)
Monitor Delay Warning : 80 -> see (39)
COM Delay Warning : 80 -> see (40)
<Disk>
Shared Disk Disconnection Retry Threshold: 10 -> see (41)
Shared Disk Disconnection Retry Timeout: 1800 -> see (42)
Shared Disk Disconnection Retry Interval: 3 -> see (43)
Shared Disk Disconnection Final Action: Disconnect forcefully
-> see (44)
<Mirror Disk>
Auto Mirror Initial Construction: On -> see (45)
Auto Mirror Recovery : On -> see (46)
Collect Mirror Statistics : On -> see (47)
Mirror Disk Disconnection Retry Threshold: 10 -> see (48)
Mirror Disk Disconnection Retry Timeout: 1800 -> see (49)
Mirror Disk Disconnection Retry Interval: 3 -> see (50)
Mirror Disk Disconnection Final Action: Disconnect forcefully
-> see (51)
<Auto Recovery>
Auto Return :Off -> see (52)
<Power Saving>
Use CPU Frequency Control :Off -> see (53)
<JVM Monitor>
Java Install Path: C:\Program Files\Java\jre6 -> see (54)
Maximum Java Heap Size (MB) : 7 -> see (55)
Load Balancer Connection Setting: BIG-IP LTM -> see (56)
Log Level : INFO -> see (57)
Generation Count for Stored Log Files: 10 -> see (58)
Log Rotation Type : File size -> see (59)
Log File Maximum Size (KB) : 3072 -> see (60)
Time of First Log Rotation : 00:00 -> see (61)
Log Rotation Interval (Hours) : 24 -> see (62)
Resource Measurement:Retry Count: 10 -> see (63)

```

```

Resource Measurement:Threshold for Abnormal Judgment: 5 -> see (64)
Resource Measurement:Default Interval: 60 -> see (65)
Resource Measurement:Interval for Full GC: 120 -> see (66)
WebLogic Monitoring:Retry Count : 3 -> see (67)
WebLogic Monitoring: Threshold for Abnormal Judgment: 5 -> see (68)
WebLogic Monitoring:Request Count Measurement Interval: 60 -> see (69)
WebLogic Monitoring: Interval for Average measurement: 300 -> see (70)
Management Port : 25500 -> see (71)
Connection Retry Count : 3 -> see (72)
Time until Reconnect : 60 -> see (73)
Management Port for Load Balancer Linkage: 25550 -> see (74)
Health Check Linkage Function : Off -> see (75)
Directory containing HTML files: C:\Program Files\Apache Software
Foundation\Tomcat 6.0\webapps\ROOT -> see (76)
HTML File Name : up.html -> see (77)
HTML Renamed File Name : down.html -> see (78)
Retry count for renaming : 3 -> see (79)
Wait time for retry : 3 -> see (80)
Management IP Address : 10.1.2.26 -> see (81)
Connection Port : 443 -> see (82)
=====

```

◆ The items in dotted frame are displayed when the --detail option is used.

Explanation of each item

- (1) Cluster : Cluster name
- (2) Comment : Comment
- <Heartbeat I/F>
- (3) Server Down Notification : Server Down Notification
- (4) Cast Method : Heartbeat Cast Method
- <NP Resolution>
- (5) Action at NP Occurrence : Action to be taken when a network partition occurs
- <Timeout>
- (6) Server Sync Wait Time : Time to wait for synchronization (in seconds)
- (7) Heartbeat Timeout : Heartbeat time-out (in milliseconds)
- (8) Heartbeat Interval : Heartbeat send interval (in milliseconds)
- (9) Server Internal Timeout : Internal communication time-out (in seconds)

- (10) Timeout Ratio : Current time-out ratio
<Port Number>
- (11) Server Internal Port Number : Internal communication port number
- (12) Data Transfer Port Number : Data transfer port number
- (13) Kernel Heartbeat Port Number : Kernel mode heartbeat port number
- (14) Client Service Port Number : Client Service Port Number
- (15) WebManager HTTP Port Number: WebManager HTTP port number
- (16) Alert Sync Port Number : Alert synchronous port number
- (17) Disk Agent Port Number : Disk Agent Port Number
- (18) Mirror Driver Port Number : Mirror Driver Port Number
<Monitor>
- (19) Collect System Resource Information
: Collect System Resource Information
<Recovery>
- (20) Max Reboot Count : Maximum reboot count
- (21) Max Reboot Count Reset Time : Time to reset the maximum reboot count (in seconds)
- (22) Use Forced Stop : Forced stop
- (23) Forced Stop Action : Forced stop action
- (24) Forced Stop Timeout (sec) : Forced stop timeout (in seconds)
- (25) Execute Script for Forced Stop : Script for forced stop
- (26) Action When the Cluster Service Process Is Failure
: Action to be taken when a cluster service process fails.
- (27) Recovery Action for HA Agents:Max Restart Count
: Action to be taken when the HA process fails: Process activation retry count.
- (28) Recovery Action for HA Agents:Recovery Action over Max Restart Count
: Action to be taken when the HA process fails: Action to be taken when the number of retries exceeded the maximum retry count.
- (29) Disable Recovery Action Caused by Monitor Resource Failure
: Disables the recovery action when the monitor resource fails.
- (30) Action at Group Resource Activation or Deactivation Stall
: Action to be taken when group resource activation/deactivation is stalled.
- (31) Restrain the shutdown action if only one server is alive
<When active group resource abnormality detected>
: When all other servers stop, the final action which does an OS stop is not performed at activation failure.
- (32) Restrain the shutdown action if only one server is alive
<When deactive group resource abnormality detected>

: When all other servers stop, the final action which does an OS stop is not performed at deactivation failure.

(33) Restrain the shutdown action if only one server is alive

<When monitoring resource abnormality detected>

: When all other servers stop, the final action which does an OS stop is not performed at monitoring failure.

<Alert Service>

(34) E-mail Address : E-mail address to be reported

(35) Use Network Warning Light : Network warning light

(36) Use Chassis Identify : Chassis Identify

(37) Enable Alert Setting : Alert setting

<Delay Warning>

(38) Heartbeat Delay Warning : Delay warning of heartbeat resource (%)

(39) Monitor Delay Warning : Delay warning of monitor resource (%)

(40) COM Delay Warning : Delay warning of COM NP resource (%)

<Disk>

(41) Shared Disk Disconnection Retry Threshold : Shared Disk Disconnection Retry Threshold

(42) Shared Disk Disconnection Retry Timeout : Shared Disk Disconnection Timeout
(in seconds)

(43) Shared Disk Disconnection Retry Interval : Shared Disk Disconnection Retry Interval
(in seconds)

(44) Shared Disk Disconnection Final Action : Shared Disk Disconnection Final Action

The items of the information on mirror are displayed when not using the Replicator/Replicator DR as well.

<Mirror Disk>

(45) Auto Mirror Initial Construction : Auto Mirror Initial Construction

(46) Auto Mirror Recovery : Auto Mirror Recovery

(47) Collect Mirror Statistics : Collect mirror statistics

(48) Mirror Disk Disconnection Retry Threshold : Mirror Disk Disconnection Retry Threshold

(49) Mirror Disk Disconnection Retry Timeout : Mirror Disk Disconnection Timeout
(in seconds)

(50) Mirror Disk Disconnection Retry Interval : Mirror Disk Disconnection Retry Interval
(in seconds)

(51) Mirror Disk Disconnection Final Action : Mirror Disk Disconnection Final Action

<Auto Recovery>

(52) Auto Recovery : Auto Recovery of Servers

<Power Saving>

(53) Use CPU Frequency Control : CPU frequency control

<JVM Monitor>

(54) Java Install Path : Java installation path

(55) Maximum Java Heap Size (MB)	: Maximum Java heap size (MB)
(56) Load Balancer Connection Setting	: Load balancer linkage settings
(57) Log Level	: Log level
(58) Generation Count for Stored Log Files	: Number of generations of log files to be stored
(59) Log Rotation Type	: Log rotation type
(60) Log File Maximum Size (KB)	: Maximum size of the log file (KB)
(61) Time of First Log Rotation	: Time at which log rotation is performed for the first time
(62) Log Rotation Interval (Hours)	: Log rotation interval (hours)
(63) Resource Measurement:Retry Count	: Resource measurement:measurement retry count
(64) Resource Measurement:Threshold for Abnormal Judgment	: Resource measurement:threshold for abnormal judgment
(65) Resource Measurement:Default Interval	: Resource measurement:memory and thread measurement interval (sec)
(66) Resource Measurement:Interval for Full GC	: Resource measurement:full GC measurement interval (sec)
(67) WebLogic Monitoring:Retry Count	: WebLogic monitoring:measurement retry count
(68) WebLogic Monitoring: Threshold for Abnormal Judgment	: WebLogic monitoring:threshold for abnormal judgment
(69) WebLogic Monitoring:request count measurement interval	: WebLogic monitoring:request count measurement interval (sec)
(70) WebLogic Monitoring:Interval for Average measurement	: WebLogic monitoring:interval for average measurement
(71) Management Port	: Management port number
(72) Connection Retry Count	: Connection retry count
(73) Time until Reconnect	: Waiting time until reconnection (sec)
(74) Management Port for Load Balancer Linkage	: Load balancer linkage management port number
(75) Health Check Linkage Function	: Link to the health check function
(76) Directory containing HTML files	: HTML storage directory
(77) HTML File Name	: HTML file name
(78) HTML Renamed File Name	: HTML rename destination file name
(79) Retry count for renaming	: Retry count at rename failure
(80) Wait time retry	: Waiting time until rename retry (sec)
(81) Management IP Address	: BIG-IP LTM management IP address
(82) Connection Port	: Communication port number for BIG-IP LTM

Displaying only the configuration data of certain servers (--sv option)

When you want to display only the cluster configuration data on a specified server, specify the name of the server after the `--sv` option in the `clpstat` command. To see the details, specify the `--detail` option. When the server name is not specified, cluster configuration data of all the servers is displayed.

Example of a command entry

```
# clpstat --sv server1 --detail
```

Example of the display after running the command:

```
===== CLUSTER INFORMATION =====
[Server0 : server1]                                -> see (1)
  Comment                : server1                  -> see (2)
  Virtual Infrastructure:  : vSphere                  -> see (3)
  Product                 : EXPRESSCLUSTER X 3.3 for Windows -> see (4)
  Internal Version        : 11.32                   -> see (5)
  Install Path            : C:\Program Files\EXPRESSCLUSTER -> see (6)
  Mirror Disk Connect IP Address : 10.0.0.1         -> see (7)
  Network Warning Light IP Address(Type)
    : 10.0.0.10 (dn1000s)                            -> see (8)
  BMC IP Address          : 10.0.0.11                -> see (9)
  CPU Frequency Status   : high                       -> see (10)
  No shutdown when double activation detected : Off   -> see (11)
```

- ◆ The items in dotted frame are displayed when the `--detail` option is used.

Explanation of each item

- (1) [Server *n*: *server_name*] (*n* is index number of a server)
- (2) Comment : Comment
- (3) Virtual Infrastructure : Virtual Infrastructure name
- (4) Product : Product
- (5) Internal Version : Internal Version
- (6) Install Path : Install Path
- (7) Mirror Disk Connect IP Address : IP address of mirror disk connection
- (8) Network Warning Light IP Address(Type)
 - : Network warning light IP address(Type)
- (9) BMC IP Address : BMC IP address
- (10) CPU Frequency Status : CPU Frequency Status
- (11) No shutdown when double activation detected : No shutdown when double activation detected

Displaying only the resource information of certain heartbeats (--hb option)

When you want to display only the cluster configuration data on a specified heartbeat resource, specify the name of the heartbeat resource after the `--hb` option in the `clpstat` command. If you want to see the details, specify the `--detail` option. When the heartbeat resource is not specified, the cluster configuration data of all the heartbeat resources is displayed.

Example of a command entry (For a kernel-mode LAN heartbeat resource)

```
# clpstat --hb lankhb1 --detail
```

Example of the display after running the command:

```
===== CLUSTER INFORMATION =====
[HB0 : lankhb1]                                -> see (1)
  Type                                           : lankhb          -> see (2)
  Comment                                        : LAN Heartbeat   -> see (3)
  <server1>
    IP Address                                  : 192.168.0.1     -> see (4)
  <server2>
    IP Address                                  : 192.168.0.2
=====
```

- ◆ The items marked by the solid line are common to all heartbeat resources.
- ◆ The lines below “Comment” are displayed when the `--detail` option is used.

Explanation of items common to heartbeat resources

- (1) [HB *n*: *heartbeat_resource_name*]
(*n* is the identification number of a heartbeat resource)
- (2) Type : Heartbeat resource type
- (3) Comment : Comment

Explanation of each item

- (4) IP Address : Interconnect address

Example of a command entry (For a BMC heartbeat resource)

```
# clpstat --hb bmchb1 --detail
```

Example of the display after running the command:

```
===== CLUSTER INFORMATION =====
[HB0 : lankhb1]
  Type                                           : lankhb
  Comment                                        : LAN Heartbeat
  <server1>
    IP Address                                  : 192.168.0.1     see (1)
  <server2>
    IP Address                                  : 192.168.0.2
=====
```

Explanation of each item

- (1) IP Address : BMC IP address

◆ Tips

By using the `--sv` option and the `--hb` option together, you can see the information as follows.

```

Command Line # clpstat --sv --hb --detail
===== CLUSTER INFORMATION =====
[Server0 : server1]
Comment           : server1
Virtual Infrastructure :
Product           : EXPRESSCLUSTER x 3.3 for Windows
Internal Version  : 11.32
Install Path      : C:\Program Files\EXPRESSCLUSTER
Mirror Disk Connect IP Address  : 10.0.0.1
Network Warning Light IP Address(Type)
                  : 10.0.0.10 (dn1000s)
BMC IP Address    : 10.0.0.11
CPU Frequency Status : high
No shutdown when double activation detected : Off
  [HB0 : lankhb1]
    Type           : lankhb
    Comment        : LAN Heartbeat
    IP Address     : 192.168.0.1
  [HB1 : lanhb2]
    Type           : lankhb
    Comment        : LAN Heartbeat
    IP Address     : 10.0.0.1
[Server1 : server2]
Comment           : server2
Virtual Infrastructure :
Product           : EXPRESSCLUSTER x 3.3 for Windows
Internal Version  : 11.32
Install Path      : C:\Program Files\EXPRESSCLUSTER
Mirror Disk Connect IP Address  : 10.0.0.2
Network Warning Light IP Address(Type)
                  : 10.0.0.10 (dn1000s)
BMC IP Address    : 10.0.0.12
CPU Frequency Status : high
No shutdown when double activation detected : Off
  [HB0 : lankhb1]
    Type           : lankhb
    Comment        : LAN Heartbeat
    IP Address     : 192.168.0.2
  [HB1 : lankhb2]
    Type           : lankhb
    Comment        : LAN Heartbeat
    IP Address     : 10.0.0.2
=====

```

Displaying only the resource information of certain network partition resolutions (--np option)

When you want to display only the cluster configuration data on a specified network partition resolution resource, specify the name of the network partition resolution resource after the `--np` option in the `clpstat` command. If you want to see the details, specify the `--detail` option. If the network partition name is not specified, the cluster configuration data on all the network partition resources is displayed.

Example of a command entry (For a DISK network partition resolution resource)

```
# clpstat --np disknp1 --detail
```

Example of the display after running the command:

```
===== CLUSTER INFORMATION =====
[NP0 : disknp1]                                -> see (1)
  Type                                           : disknp          -> see (2)
  Comment                                        : disk resolution -> see (3)
  <server1>
    Volume Mount Point                          : H:\              -> see (4)
    Disk I/O Wait Time                          : 80               -> see (5)
  <server2>
    Volume Mount Point                          : H:\
    Disk I/O Wait Time                          : 80
=====
```

- ◆ The items marked by the solid line are common to all network partition resolution resources.
- ◆ The lines below “Comment” are displayed when the `--detail` option is used.

Information common to all network partition resolution resources

- (1) [NP *n* : *network partition resolution resource name*]
(*n* is the identification number of a network partition resolution resource)
- (2) Type : Network partition resolution resource type
- (3) Comment : Comment

Explanation of each items

- (4) Volume Mount Point : Volume mount point
- (5) Disk I/O Wait Time : Disk I/O wait time

Example of a command entry (For a COM network partition resolution resource)

```
# clpstat --np comnp1 --detail
```

Example of the display after running the command:

```
===== CLUSTER INFORMATION =====
[NP0 : comnp1]
  Type                                           : comnp
  Comment                                        : com resolution
  <server1>
    Port Name                                   : COM1              -> see (1)
  <server2>
    Port Name                                   : COM1
=====
```

Explanation of each item

- (1) Port Name : COM port name

Example of a command entry (For a PING network partition resolution resource)

```
# clpstat --np pingnp1 --detail
```

Example of the display after running the command:

```
===== CLUSTER INFORMATION =====
[NP0 : pingnp1]
  Type           : pingnp
  Comment        : ping resolution
  <server1>
    IP Addresses   : 10.0.0.254      -> see (1)
    Ping Interval  : 5                -> see (2)
    Ping Timeout   : 3                -> see (3)
    Ping Retry Count : 3              -> see (4)
  <server2>
    IP Addresses   : 10.0.0.254
    Ping Interval  : 5
    Ping Timeout   : 3
    Ping Retry Count : 3
=====
```

Explanation of each items

- (1) IP Addresses : IP addresses of ping destination
- (2) Ping Interval: Ping interval (in seconds)
- (3) Ping Timeout : Ping time-out (in seconds)
- (4) Ping Retry Count : Ping retry count

Example of a command entry (For a majority network partition resolution resource)

```
# clpstat --np majonp1 --detail
```

Example of the display after running the command:

```
===== CLUSTER INFORMATION =====
[NP0 : majonp1]
  Type           : majonp
  Comment        : majority resolution
=====
```

Explanation of each item

There is no item specific to a majority network partition resolution resource.

Displaying only the configuration data of certain server groups (--svg option)

When you want to display only the cluster configuration data on a specified server group, specify the name of the server group after the `--svg` option in the `clpstat` command. When a server group name is not specified, the cluster configuration data on all the server groups is displayed.

Example of a command entry

```
# clpstat --svg servergroup1
```

Example of the display after running the command:

```
===== CLUSTER INFORMATION =====
[Server group 0 : servergroup1]  -> see (1)
  Server0 : server1              -> see (2)
  Server1 : server2              -> see (2)
  Server2 : server3              -> see (2)
=====
```

Explanation of each item

- (1) [ServerGroup *n* : *server_group_name*] (*n* is the identification number of a server group)
- (2) Server *n* : *n* is the priority number in a server group

Displaying only the configuration data of certain groups (--grp option)

When you want to display only the cluster configuration data on a specified group, specify the name of the group after the `--grp` option in the `clpstat` command. If you want to see the details, specify the `--detail` option. When the group name is not specified, the cluster configuration data on all the groups is displayed.

Example of a command entry

```
# clpstat --grp --detail
```

Example of the display after running the command:

```
===== CLUSTER INFORMATION =====
[Group0 : ManagementGroup] -> see (1)
  Type                       : cluster          -> see (2)
  Comment                     :                   -> see (3)
  Startup Attribute           : Auto Startup    -> see (4)
  Failover Exclusive Attribute : Off            -> see (5)
  Failback Attribute          : Manual Failback -> see (6)
  Failover Attribute          : Auto Failover  -> see (7)
  Servers that can run the Group: 0 server1        -> see (8)
[Group1 : failover1] -> see (1)
  Type                       : failover          -> see (2)
  Comment                     : failover group1    -> see (3)
  Startup Attribute           : Auto Startup    -> see (4)
  Failover Exclusive Attribute : Off            -> see (5)
  Failback Attribute          : Manual Failback -> see (6)
  Failover Attribute          : Manual Failover  -> see (7)
  Servers that can run the Group: 0 server1        -> see (8)
                                   : 1 server2
[Group2 : failover2]
  Type                       : failover          -> see (2)
  Comment                     : failover group2    -> see (3)
  Startup Attribute           : Auto Startup    -> see (4)
  Failover Exclusive Attribute : Off            -> see (5)
  Failback Attribute          : Auto Failback    -> see (6)
  Failover Attribute          : Auto Failover    -> see (7)
  Servers that can run the Group: 0 server1        -> see (8)
                                   : 1 server2
[Group3 : virtualmachine1]
  Type                       : virtualmachine     -> see (2)
  Comment                     :                   -> see (3)
  Startup Attribute           : Auto Startup    -> see (4)
  Failover Exclusive Attribute : Off            -> see (5)
  Failback Attribute          : Auto Failback    -> see (6)
  Failover Attribute          : Auto Failover    -> see (7)
  Servers that can run the Group: 0 server1        -> see (8)
                                   : 1 server2
=====
```

- ◆ The items below “Comment” are displayed when the `--detail` option is used.

Explanation of each item

- (1) [Group *n* : *group_name*] (*n* is the identification number of a group)
- (2) Type : Group type
- (3) Comment : Comment
- (4) Startup Attribute : Startup type
 - Manual Startup
 - Auto Startup
- (5) Failover Exclusive Attribute : Startup exclusive attributes
 - No Exclusion
 - Normal
 - Absolute
- (6) Failback Attribute : Failback attribute
 - Manual Failback
 - Auto (The order of servers that can run the Group)
 - Auto (Dynamic)
 - Auto (Prioritized in the Server Group / Automatic among the Server Group)
 - Auto (Prioritized in the Server Group / Manual among the Server Group)
- (7) Failover Attribute : Failover attribute
 - Manual Failover
 - Auto Failover
- (8) Servers that can run the Group : Failover order
 Servers that can run the Group are displayed in the failover policy sequence.

Displaying only the configuration data of a certain group resource (--rsc option)

When you want to display only the cluster configuration data on a specified group resource, specify the group resource after the `--rsc` option in the `clpstat` command. If you want to see the details, specify the `--detail` option. When the group resource name is not specified, the cluster configuration data on all the group resources is displayed.

Example of a command entry (For floating IP resource)

```
# clpstat --rsc fip1 --detail
```

Example of the display after running the command:

```
===== CLUSTER INFORMATION =====
[Resource0 : fip1] ->see (1)
  Type                : fip -> see (2)
  Comment              : 10.0.0.11 -> see (3)
  Failover Target Server : stable operation server-> see (4)
  Failover Threshold   : Number of Servers -> see (5)
  Retry Count at Activation Failure: 5 -> see (6)
  Retry Interval at Activation Failure: 5 -> see (7)
  Final Action at Activation Failure:
  No Operation (Not activate next resource) -> see (8)
  Execute Script before Final Action: Off -> see (9)
  Retry Count at Deactivation Failure : 0 -> see (10)
  Retry Interval at Inactivation Failure: 5 -> see (11)
  Final Action at Deactivation Failure: Stop the cluster
  service and shut down OS -> see (12)
  Execute Script before Final Action: Off -> see (13)
  Depended Resources   : ->see (14)
  IP Address           : 10.0.0.11 -> see (15)
  Run ping             : On -> see (16)
  Ping Timeout (msec)  : 1000 -> see (17)
  Ping Retry Count     : 5 -> see (18)
  Ping Retry Interval (sec) : 1 -> see (19)
  FIP Force Activation : Off -> see (20)
  Send GARP Retry Threshold : 3 -> see (21)
  Send GARP Retry Interval (seconds): 1 -> see (22)
=====
```

- The items marked by the solid line are common to all resources.
- The items marked by the dotted lines are displayed when the `--detail` option is used.

Information common to all group resources

- (1) [Resource n : *group_resource_name*] (n is the identification number of group resource)
- (2) Type : Group resource type
- (3) Comment : Comment
- (4) Failover Target Server : Failover target server
 - **The most prioritized server**
 - **Stable operation server**
- (5) Failover Threshold : Failover count

- (6) Retry Count at Activation Failure : Activation retry count
- (7) Retry Interval at Activation Failure : Activation retry interval (in seconds)
- (8) Final Action at Activation Failure : Final action at activation failures
 - **No Operation (Activate next resource)**
 - **No Operation (Not activate next resource)**
 - **Stop Group**
 - **Stop cluster service**
 - **Stop the cluster service and shut down**
 - **Stop cluster service and reboot OS**
 - **Generate an Intentional Stop Error**
- (9) Execute Script before Final Action : Whether or not to execute script upon activation failure
- (10) Retry Count at Deactivation Failure : Deactivation retry count
- (11) Retry Interval at Inactivation Failure : Deactivation retry interval (in seconds)
- (12) Final Action at Deactivation Failure : Final action at inactivation failures
 - **No Operation (Deactivate next resource)**
 - **No Operation (Not deactivate next resource)**
 - **Stop the cluster service and shut down**
 - **Stop cluster service and reboot OS**
 - **Generate an Intentional Stop Error**
- (13) Execute Script before Final Action : Whether or not to execute script upon deactivation failure
- (14) Dependent Resources : Dependent resources

Explanation of each item

- (15) IP Address : Floating IP address
- (16) Run ping : Run ping / Do not run ping
- (17) Ping Timeout (msec) : Time-out of ping to confirm redundancy (in milliseconds)
- (18) Ping Retry Count : ping retry count
- (19) Ping Retry Interval (sec) : ping retry interval (in seconds)
- (20) Forced FIP Activation : Floating IP force activation
- (21) Send GARP Retry Threshold : GARP send retry count at activation
- (22) Send GARP Retry Interval (seconds) : GARP send retry interval at activation

Example of a command entry (For virtual IP resource)

```
# clpstat --rsc vip1 --detail
```

Example of the display after running the command:

```
===== CLUSTER INFORMATION =====
[Resource0 : vip1]
Type : vip
Comment : 10.0.1.11
Failover Target Server : stable operation server
Failover Threshold : Number of Servers
Retry Count at Activation Failure: 5
Retry Interval at Activation Failure: 5
Final Action at Activation Failure: No Operation (Not activate
next resource)
Execute Script before Final Action: Off
Retry Count at Deactivation Failure: 0
Retry Interval at Inactivation Failure: 0
Final Action at Deactivation Failure: Stop the cluster service
and shut down OS
Execute Script before Final Action: Off
Dependent Resources :
IP Address : 10.0.1.11 see-> (1)
Subnet Mask : 255.255.255.0 see -> (2)
Run ping : Enable see -> (3)
ping Timeout (msec) : 1000 see -> (4)
Ping Retry Count : 5 see -> (5)
Ping Retry Interval (sec) : 1 see -> (6)
VIP Force Activation : Disable see -> (7)
Destination IP Address : 192.168.0.255 see -> (8)
Source IP Address : 192.168.0.1 see -> (9)
Send interval : 30 see -> (10)
Routing Protocol : RIPver1 see -> (11)
RIP Next Hop IP Address : see -> (12)
RIP Metric : 3 see -> (13)
RIP Port Number : 520 see -> (14)
RIPng Metric : 1 see -> (15)
RIPng Port Number : 521 see -> (16)
```

Explanation of each item

- (1) IP Address : Virtual IP address
- (2) Subnet Mask : Subnet mask of the virtual IP address
- (3) Run ping : Run ping / Do not run ping
- (4) Ping Timeout (msec) : Time-out of ping to confirm redundancy (in milliseconds)
- (5) Ping Retry Count : Ping retry count
- (6) Ping Retry Interval (sec) : Ping retry interval (in seconds)
- (7) VIP Forced Activation : Virtual IP forced activation
- (8) Destination IP Address : Destination IP address of RIP packets
- (9) Source IP Address : IP address to bind for sending RIP packets
- (10) Send interval : Send interval of RIP packets
- (11) Routing Protocol : RIP version

- (12) RIP Next Hop IP Address : The next hop address (address of the next router)
- (13) RIP Metric : A metric value of RIP
- (14) RIP Port Number : The ports used for sending RIP
- (15) RIPng Metric : A metric value of RIPng
- (16) RIPng Port Number : The ports used for sending RIPng

Example of a command entry (For virtual computer name resource)

```
# clpstat --rsc vcom1 --detail
```

Example of the display after running the command:

```
===== CLUSTER INFORMATION =====
[Resource0 : vcom1]
Type : vcom
Comment : vcom1
Failover Target Server : stable operation server
Failover Threshold : Number of Servers
Retry Count at Activation Failure: 5
Retry interval at Activation Failure: 5
Final Action at Activation Failure: No Operation (Not activate
next resource)
Execute Script before Final Action: Off
Retry Count at Deactivation Failure: 0
Retry interval at Activation Failure: 5
Final Action at Deactivation Failure: Stop the cluster service
and shut down OS
Execute Script before Final Action: Off
Dependent Resources : fip1
Virtual Computer Name : vcom1 -> see (1)
Target FIP Resource Name : fip1 -> see (2)
=====
```

Explanation of each item

- (1) Virtual Computer Name : Virtual computer name
- (2) Target FIP Resource Name : bind target FIP resource name

Example of a command entry (For disk resource)

```
# clpstat --rsc sd1 --detail
```

Example of the display after running the command:

```
===== CLUSTER INFORMATION =====
[Resource 0 : sd1]
Type                : sd
Comment             : I:
Failover Target Server : stable operation server
Failover Threshold  : Number of Servers
Retry Count at Activation Failure: 3
Retry Interval at Activation Failure : 5
Final Action at Activation Failure: No Operation (Not activate
                                next resource)
Execute Script before Final Action: Off
Retry Count at Deactivation Failure: 0
Retry Interval at Inactivation Failure : 5
Final Action at Deactivation Failure: Stop the cluster service
                                and shutdown OS
Execute Script before Final Action: Off
Dependent Resources : disk1,fipl
Drive Letter        : I:                -> see (1)
=====
```

Explanation of each item

(1) Drive Letter : Mount point of the volume

Example of a command entry (Mirror disk resource: when the Replicator is used)

```
# clpstat --rsc md1 --detail
```

Example of the display after running the command:

```
===== CLUSTER_INFORMATION =====
[Resource0 : md1]
Type : md
Comment : I:
Failover Target Server : stable operation server
Failover Threshold : Number of Servers
Retry Count at Activation Failure: 3
Retry Interval at Activation Failure : 5
Final Action at Activation Failure: No Operation (Not activate
next resource)

Execute Script before Final Action: Off
Retry Count at Deactivation Failure: 0
Retry Interval at Inactivation Failure : 5
Final Action at Deactivation Failure: Stop the cluster service
and shut down OS

Execute Script before Final Action: Off
Depended Resources :
Mirror Disk No. : 1 -> see (1)
Drive Letter : I: -> see (2)
Cluster Partition - Drive Letter: H: -> see (3)
Cluster Partition - Offset Index : 0 -> see (4)
Mirror Disk Connect : mdc1 -> see (5)
: mdc2

Initial mirror construction : Enable -> see (6)
Mode : Synchronous -> see (7)
Request Queue Maximum Size(KB): 2048 -> see (8)
Mirror Connect Timeout(sec) : 20 -> see (9)
Asynchronous - History Files Store Folder: -> see (10)
Asynchronous - Kernel Queue Size (KB): 2048 -> see (11)
Asynchronous - Application Queue Size(KB): 2048 -> see (12)
Asynchronous - Thread Timeout(sec): 30 -> see (13)
Asynchronous - Max. Size of History File (MB)
: Unlimited -> see (14)
Asynchronous - Upper Bound of Communication Band(KB/sec)
: Unlimited -> see (15)
Compress Data : No -> see (16)
=====
```

Explanation of each item

- (1) Mirror Disk No. : Mirror disk number
- (2) Drive Letter : Drive letter
- (3) Cluster Partition - Drive letter : Drive letter
- (4) Cluster Partition - Offset Index : Offset index
- (5) Mirror Disk Connect : Mirror disk connect name of the communication part for mirroring
- (6) Execute the initial mirror construction : Execute the initial mirror construction/Do not execute the initial mirror construction
- (7) Mode : Synchronous/Asynchronous
- (8) Request Queue Maximum Size(KB) : Maximum size of the request queue (KB)

- (9) Mirror Connect Timeout(sec) : Mirror connect time-out (in seconds)
- (10) Asynchronous - History Files Store Folder : History file storage folder
- (11) Asynchronous - Kernel Queue Size (KB): Kernel queue size (KB)
- (12) Asynchronous - Application Queue Size(KB) : Application queue size (KB)
- (13) Asynchronous - Thread Timeout(sec): Thread time-out (in seconds)
- (14) Asynchronous – Max. Size of History File (MB): Size limitation of History File
- (15) Asynchronous – Upper Bound of Communication Band(KB/sec) : Set the upper limit of the communication band used by the mirror connect
- (16) Compress Data : Specify whether to compress the mirror data flowing through the mirror disk connect

Example of a command entry (For print spooler resource)

```
# clpstat --rsc spool1 --detail
```

Example of the display after running the command:

```
===== CLUSTER INFORMATION =====
[Resource0 : spool1]
  Type                : spool
  Comment              :
  Failover Target Server : stable operation server
  Failover Threshold   : Number of Servers
  Retry Count at Activation Failure: 0
  Retry Interval at Activation Failure : 5
  Final Action at Activation Failure: No Operation (Not activate
                                     next resource)
  Execute Script before Final Action: Off
  Retry Count at Deactivation Failure: 0
  Retry Interval at Inactivation Failure : 5
  Final Action at Deactivation Failure: Stop the cluster service
                                     and shutdown OS
Execute Script before Final Action: Off
  Dependent Resources   : mdl
  Printer Name          : NEC MultiImpact 700EX -> see (1)
  Partition             : I: -> see (2)
  Spool Directory       : \SPOOL1 -> see (3)
=====
```

Explanation of each item

- (1) Printer Name : Printer name
- (2) Partition : Partition
- (3) Spool directory : Spool directory

Example of a command entry (For a registry synchronization resource)

```
# clpstat --rsc regsync1 --detail
```

Example of the display after running the command:

```
===== CLUSTER INFORMATION =====
```

```
[Resource0 : regsync1]
Type : regsync
Comment :
Failover Target Server : stable operation server
Failover Threshold : Number of Servers
Retry Count at Activation Failure: 0
Retry Interval at Activation Failure : 5
Final Action at Activation Failure: No Operation (Not activate
next resource)
Execute Script before Final Action: Off
Retry Count at Deactivation Failure: 0
Retry Interval at Inactivation Failure : 5
Final Action at Deactivation Failure: Stop the cluster service
and shutdown OS
Execute Script before Final Action: Off
Dependent Resources : fipl,vcom1,mdl
Registry Key : HKEY_LOCAL_MACHINE\SOFTWARE\A
-> see (1)
```

Explanation of each item

(1) Registry Key : Registry key

Example of a command entry (For application resource)

```
# clpstat --rsc appli1 --detail
```

Example of the display after running the command:

```
===== CLUSTER INFORMATION =====
[Resource0 : appli1]
Type : appli
Comment : notepad
Failover Target Server : stable operation server
Failover Threshold : Number of Servers
Retry Count at Activation Failure : 0
Retry Interval at Activation Failure : 5
Final Action at Activation Failure: No Operation (Not activate
next resource)
Execute Script before Final Action: Off
Retry Count at Deactivation Failure: 0
Retry Interval at Inactivation Failure : 5
Final Action at Deactivation Failure: Stop the cluster service
and shutdown OS
Execute Script before Final Action: Off
Depended Resources : fip1,vcom,mdl
Resident Type : Resident -> see (1)
Target VCOM Resource Name : -> see (2)
Start Path : C:\WINDOWS\notepad.exe-> see (3)
[Start]Type : Synchronous -> see (4)
[Start]Timeout(sec) : 1800 -> see (5)
[Start]Current Directory : -> see (6)
[Start]Option Parameter : -> see (7)
[Start]Window Size : Hide -> see (8)
[Start]Domain : -> see (9)
[Start]Account : -> see (10)
[Start]Allow to Interact with Desktop: Off -> see (11)
[Start]Execute from the Command Prompt: Off -> see (12)
[Start]Normal Return Value: -> see (13)
Stop Path : -> see (14)
[Stop ]Type : Synchronous -> see (15)
[Stop ]Timeout(sec) : 1800 -> see (16)
[Stop ]Current Directory : -> see (17)
[Stop ]Option Parameter : -> see (18)
[Stop ]Window Size : Hide -> see (19)
[Stop ]Domain : -> see (20)
[Stop ]Account : -> see (21)
[Stop ]Allow to Interact with Desktop: Off -> see (22)
[Stop ]Execute from the Command Prompt: Off -> see (23)
[Stop ]Normal Return Value: -> see (24)
=====
```

Explanation of each item

- (1) Resident Type : Resident/Non-Resident
- (2) Target VCOM Resource Name : Virtual computer name resource of target
- (3) Start Path : Application path at start
- (4) [Start] Type : Synchronous/Asynchronous at start

- (5) [Start] Timeout (sec) :Time-out period at start (in seconds)
- (6) [Start] Current Directory : Execution directory at start
- (7) [Start] Option Parameter : Option parameter at start
- (8) [Start] Window Size :Window size at start
- (9) [Start] Domain :Domain at start
- (10) [Start] Account :Account at start
- (11) [Start] Allow to Interact with Desktop :Allow to interact with desktop at start/Do not allow to interact with desktop at start
- (12) [Start] Execute from the Command Prompt :Execute from the command prompt at start/Do not Execute from the command prompt at start
- (13) [Start]Normal Return Value : The return value from the execution file of the start path when it normally ended
- (14) Stop Path : Application path at stop
- (15) [Stop]Type : Synchronous/Asynchronous at stop
- (16) [Stop]Timeout(sec) : Time-out period at stop (in seconds)
- (17) [Stop]Current Directory : Execution directory at stop
- (18) [Stop]Option Parameter : Option parameter at stop
- (19) [Stop]Window Size : Window size at stop
- (20) [Stop]Domain : Domain at stop
- (21) [Stop]Account : Account at stop
- (22) [Stop]Allow to Interact with Desktop : Allow to interact with desktop at stop/Do not allow to interact with desktop at stop
- (23) [Stop]Execute from the Command Prompt : Execute from the command prompt at stop/Do not execute from the command prompt at stop
- (24) [Stop]Normal Return Value : The return value from the execution file of the stop path when it normally ended

Example of a command entry (For script resource)

```
# clpstat --rsc script1 --detail
```

Example of the display after running the command:

```
===== CLUSTER INFORMATION =====
[Resource0 : script1]
Type : script
Comment : script_resource1
Failover Target Server : stable operation server
Failover Threshold : Number of Servers
Retry Count at Activation Failure: 0
Retry Interval at Activation Failure : 5
Final Action at Activation Failure: No Operation (Not activate
next resource)
Execute Script before Final Action: Off
Retry Count at Deactivation Failure: 0
Retry Interval at Inactivation Failure : 5
Final Action at Deactivation Failure: Stop the cluster service
and shut down OS
Execute Script before Final Action: Off
Depended Resources : fip1,vcom,mdl
Target VCOM Resource Name : -> see (1)
Start Path : start.bat -> see (2)
[Start]Type : Synchronous -> see (3)
[Start]Timeout(seconds) : 1800 -> see (4)
[Start]Allow to Interact with Desktop: Disable -> see (5)
[Start]Normal Return Value : -> see (6)
Stop Path : stop.bat -> see (7)
[Stop ]Type : Synchronous -> see (8)
[Stop ]Timeout(seconds) : 1800 -> see (9)
[Stop ]Allow to Interact with Desktop:Disable -> see (10)
[Stop ]Normal Return Value : -> see (11)
=====
```

Explanation of each item

- (1) Target VCOM Resource Name : Target VCOM resource name
- (2) Start Path : Path of start script
- (3) [Start] Type :Synchronous/Asynchronous of start script path
- (4) [Start] Timeout (sec) :Time-out period of start script (in seconds)
- (5) [Start] Allow to Interact with Desktop :Allow to interact with desktop at start / Do not allow to interact with desktop at start
- (6) [Start]Normal Return Value : Configure what error code from the script is normal
- (7) Stop Path : Path of stop script
- (8) [Stop]Type : Synchronous/Asynchronous of stop script
- (9) [Stop]Timeout (sec) : Time-out period (in seconds) of stop script
- (10) [Stop]Allow to Interact with Desktop : Allow to interact with desktop at stop /Do not allow to interact with desktop at stop
- (11) [Stop]Normal Return Value : Configure what error code from the script is normal

Example of a command entry (For service resource)

```
# clpstat --rsc servicel --detail
```

Example of the display after running the command:

```
===== CLUSTER INFORMATION =====
[Resource0 : servicel]
Type : service
Comment : Telnet
Failover Target Server : stable operation server
Failover Threshold : Number of Servers
Retry Count at Activation Failure : 0
Retry Interval at Activation Failure : 5
Final Action at Activation Failure: No Operation (Not activate
next resource)
Execute Script before Final Action: Off
Retry Count at Deactivation Failure: 0
Retry Interval at Inactivation Failure : 5
Final Action at Deactivation Failure: Stop the cluster service
and shut down OS
Execute Script before Final Action: Off
Dependent Resources : fip1,vcom,mdl
Service Name : Telnet -> see (1)
Start Parameters : -> see (2)
Do not assume it as an error when the service is already started:
Disable -> see (3)
Target VCOM Resource Name : -> see (4)
[Start] Type : Synchronous -> see (5)
[Start] Timeout(sec) : 1800 -> see (6)
[Stop]Type : Synchronous -> see (7)
[Stop]Timeout(sec) : 1800 -> see (8)
=====
```

Explanation of each item

- (1) Service Name : Service name/Service display name
- (2) Start Parameter : Parameter to give when service starts
- (3) Do not assume it as an error when the service is already started : Behaviors when service has been already started
- (4) Target VCOM Resource Name : Target VCOM resource name
- (5) [Start] Type :Synchronous/Asynchronous when service starts
- (6) [Start] Timeout (sec) :Time-out period (in seconds) when service starts
- (7) [Stop] Type :Synchronous/Asynchronous when service stops
- (8) [Stop] Timeout(sec) :Time-out period (in seconds) when service stops

Example of a command entry (For cifs resource)

```
# clpstat --rsc cifs1 --detail
```

Example of the display after running the command:

```
===== CLUSTER INFORMATION =====
[Resource0 : cifs1]
Type : cifs
Comment :
Failover Target Server : stable operation server
Failover Threshold : Number of Servers
Retry Count at Activation Failure : 0
Retry Interval at Activation Failure : 5
Final Action at Activation Failure: No Operation (Not activate
next resource)
Execute Script before Final Action: Off
Retry Count at Deactivation Failure: 0
Retry Interval at Inactivation Failure : 5
Final Action at Deactivation Failure: Stop the cluster service
and shut down OS
Execute Script before Final Action: Off
Dependent Resources : sd,md,hd
Share Name : -> see (1)
Path : -> see (2)
Comment : -> see (3)
User Limit : Maximum Allowed -> see (4)
Client-side Cache : Off -> see (5)
CSC Method : Automatic Caching -> see (6)
Drive Administration : On -> see (7)
Drive : M: -> see (8)
Config File Path : M:\share_clp.conf -> see (9)
File share setting restoration error check :On -> see (10)
Do not treat shared file name overlap as error :Off -> see (11)
=====
```

Explanation of each item

- (1) Share Name : Name of the shared folder publicized by CIFS resource
- (2) Path : Path to the shared folder publicized by CIFS resource
- (3) Comment : CIFS resource comment
- (4) User Limit : Maximum number of users that can simultaneously connect to the shared folder publicized by CIFS resource
- (5) Client-side Cache : Whether or not to cache of the shared folder publicized by CIFS resource
- (6) CSC Method : Cache method of the shared folder publicized in CIFS resource
- (7) Drive Administration : Execute auto-saving of shared configuration
- (8) Drive : Target drive to execute auto-saving of shared configuration
- (9) Config File Path : File path to save share configuration
- (10) File share setting restoration error check : Enabling or disabling of **Errors in restoring file share setting are treated as activity failure**

- (11) Do not treat shared file name overlap as error
: Enabling or disabling of **Not regarded as an activation error
when the folder has already been shared**

Example of a command entry (For nas resource)

```
# clpstat --rsc nas1 --detail
```

Example of the display after running the command:

```
===== CLUSTER INFORMATION =====
[Resource0 : nas1]
Type : nas
Comment :
Failover Target Server : stable operation server
Failover Threshold : Number of Servers
Retry Count at Activation Failure : 0
Retry Interval at Activation Failure : 5
Final Action at Activation Failure: No Operation (Not activate
next resource)
Execute Script before Final Action: Off
Retry Count at Deactivation Failure: 0
Retry Interval at Inactivation Failure : 5
Final Action at Deactivation Failure: No Operation (Not deactivate
next resource)
Execute Script before Final Action: Off
Dependent Resources : fip,vip
Drive : N: -> see (1)
Network Resource : \\file_server\nas1 -> see (2)
User Name : file_server\user1 -> see (3)
Disconnect Retry Threshold : 3 -> see (4)
Disconnect Retry Interval(seconds): 5 -> see (5)
=====
```

Explanation of each item

- (1) Drive : Drive letters for network drive mounted by NAS resource
- (2) Network Resource : Shared folders mounted by NAS resource
- (3) User Name : Account user name to mount shared folders in NAS resource
- (4) Disconnect Retry Threshold : The number of retries to be performed when unmounting fails
- (5) Disconnect Retry Interval (seconds) : Interval between retries that are performed when unmounting fails

Example of a command entry (For hybrid disk resource)

```
# clpstat --rsc hd1 --detail
```

Example of the display after running the command:

```
===== CLUSTER INFORMATION =====
[Resource0 : hd1]
Type                : hd
Comment             :
Failover Target Server : stable operation server
Failover Threshold   : Number of Servers
Retry Count at Activation Failure : 3
Retry Interval at Activation Failure : 5
Final Action at Activation Failure: No Operation (Not activate
                                next resource)
Execute Script before Final Action: Off
Retry Count at Deactivation Failure: 0
Retry Interval at Inactivation Failure : 5
Final Action at Deactivation Failure: Stop the cluster service
                                and shut down OS
Execute Script before Final Action: Off
Dependent Resources :
Mirror Disk No.      : 2                -> see (1)
Drive Letter         : I:              -> see (2)
Cluster Partition - Drive Letter: H:    -> see (3)
Cluster Partition - Offset Index : 0    -> see (4)
Mirror Disk Connect  : mdcl            -> see (5)
                                : mdc2
Initial mirror construction : Enable   -> see (6)
Mode                  : Synchronous  -> see (7)
Request Queue Maximum Size(KB): 2048   -> see (8)
Mirror Connect Timeout(sec) : 20       -> see (9)
Asynchronous - History Files Store Folder: -> see (10)
Asynchronous - Kernel Queue Size (KB): 2048 -> see (11)
Asynchronous - Application Queue Size(KB): 2048 -> see (12)
Asynchronous - Thread Timeout(sec): 30  -> see (13)
Asynchronous - Max. Size of History File (MB)
                                : Unlimited -> see (14)
Asynchronous - Upper Bound of Communication Band (KB/sec)
                                : Unlimited -> see (15)
Compress Data        : No              -> see (16)
=====
```

Explanation of each item

- (1) Mirror Disk No. : Mirror disk number
- (2) Drive Letter : Drive letter
- (3) Cluster Partition - Drive letter : Drive letter
- (4) Cluster Partition - Offset Index : Offset index
- (5) Mirror Disk Connect : Mirror disk connect name of the communication part for mirroring
- (6) Execute the initial mirror construction : Execute the initial mirror construction/Do not execute the initial mirror construction
- (7) Mode : Synchronous/Asynchronous
- (8) Request Queue Maximum Size(KB) : Maximum size of the request queue (KB)

- (9) Mirror Connect Timeout(sec) : Mirror connect time-out (in seconds)
- (10) Asynchronous - History Files Store Folder : History file storage folder
- (11) Asynchronous - Kernel Queue Size (KB): Kernel queue size (KB)
- (12) Asynchronous - Application Queue Size(KB) : Application queue size (KB)
- (13) Asynchronous - Thread Timeout(sec): Thread time-out (in seconds)
- (14) Asynchronous – Max. Size of History File (MB): Size limitation of History File
- (15) Asynchronous – Upper Bound of Communication Band(KB/sec) : Set the upper limit of the communication band used by the mirror connect
- (16) Compress Data : Specify whether to compress the mirror data flowing through the mirror disk connect

Example of a command entry (For virtual machine resource)

```
# clpstat --rsc vm1 --detail
```

Example of the display after running the command:

```
===== CLUSTER INFORMATION =====
[Resource0 : vm1]
Type                : vm
Comment             :
Failover Target Server : stable operation server
Failover Threshold   : Number of Servers
Retry Count at Activation Failure : 5
Retry Interval at Activation Failure : 5
Final Action at Activation Failure: No Operation (Not activate
                                next resource)
Execute Script before Final Action: Off
Retry Count at Deactivation Failure: 0
Retry Interval at Inactivation Failure : 5
Final Action at Deactivation Failure: Stop the cluster service
                                and shut down OS
Execute Script before Final Action: Off
Dependent Resources :
VM Type              : Hyper-V                -> see (1)
VM Name              : vm                    -> see (2)
VM Config File Path  : X:\vm0                -> see (3)
Timeout Of Request (seconds): 180            -> see (4)
Timeout Of Start (seconds): 0                -> see (5)
Timeout Of Stop (seconds): 60                -> see (6)
=====
```

Explanation of each item

- (1) VM Type : The virtualization infrastructure in which the virtual machine is set up.
- (2) VM Name : The virtual machine name displayed in the Hyper-V Manager.
- (3) VM Config File Path : The path of the virtual machine configuration file.
- (4) Timeout Of Request (seconds) : The wait time to wait for completion of a request such as to start or stop a virtual machine.
- (5) Timeout Of Start (seconds) : The wait time to wait for the startup completion of the guest OS on the virtual machine and the application after the request to the virtual machine to start up completes and the status of the virtual machine becomes running at the resource activation.
- (6) Timeout Of Stop (seconds) : The wait time for the shutdown of the guest OS on the virtual machine at the resource deactivation.

Example of a command entry (For dynamic DNS resource)

```
# clpstat --rsc ddns1 --detail
```

Example of the display after running the command:

```
===== CLUSTER INFORMATION =====
[Resource0 : ddns1]
Type : ddns
Comment :
Failover Target Server : stable operation
server
Failover Threshold : Number of Servers
Retry Count at Activation Failure : 5
Retry Interval at Action Failure : 5
Final Action at Activation Failure : No Operation
(Not activate next
resource)
Execute Script before Final Action : Off
Retry Count at Deactivation Failure : 0
Retry Interval at Inactivation Failure : 5
Final Action at Deactivation Failure : Stop the cluster
service and shutdown
OS
Execute Script before Final Action : Off
Dependent Resources :
DDNS Server : 10.0.0.10 (1)
Port No. : 53 (2)
Virtual Host Name : xxx.example.com (3)
IP Address : 10.0.0.1 (4)
Cache TTL (sec) : 0 (5)
DNS update interval (sec) : 3600 (6)
DNS dynamic update : On (7)
DNS registered IP delete : Off (8)
Enable Kerberos Authentication : Off (9)
=====
```

Explanation of each item

- | | |
|--|---|
| (1) DDNS Server | : IP address of the DDNS server |
| (2) Port No. | : Port number of the DDNS server |
| (3) Virtual Host Name | : Virtual host name |
| (4) IP Address | : IP address |
| (5) Cache TTL (sec) | : TTL for the cache (in seconds) |
| (6) DNS update interval (sec)
server (in seconds) | : Update interval for registration with DDNS |
| (7) DNS dynamic update | : Whether to update the DDNS server |
| (8) DNS registered IP delete | : Whether to delete the IP address that was
registered at deactivation |
| (9) Enable Kerberos Authentication | : Enable/disable Kerberos authentication |

Example of a command entry (for AWS elastic ip resources)

```
# clpstat --rsc awseip1 --detail
```

Example of the display after running the command:

```
===== CLUSTER INFORMATION =====
[Resource0 : awseip1]
Type                : awseip
Comment             :
Failover Target Server : stable operation server
Failover Threshold   : Number of Servers
Retry Count at Activation Failure : 5
Retry Interval at Activation Failure : 5
Final Action at Activation Failure : No Operation (Not
activate next resource)
Execute Script before Final Action : Off
Retry Count at Deactivation Failure : 0
Retry Interval at Deactivation Failure : 5
Final Action at Deactivation Failure : Stop the cluster
service and shut down OS
Execute Script before Final Action : Off
Dependent Resources :
EIP ALLOCATION ID    : eipalloc-00000000    -> see (1)
ENI ID              : eni-00000000        -> see (2)
AWS CLI Timeout(sec) : 60                 -> see (3)
=====
```

Explanation of each item

- (1) EIP ALLOCATION ID: ID of the EIP to replace
- (2) ENI ID: ENI ID to which to allocate the EIP
- (3) AWS CLI Timeout(sec) : Time out of the AWS CLI

Example of a command entry (for AWS virtual ip resources)

```
# clpstat --rsc awsvip1 --detail
```

Example of the display after running the command:

```
===== CLUSTER INFORMATION =====
[Resource0 : awsvip1]
Type                : awsvip
Comment             :
Failover Target Server : stable operation server
Failover Threshold   : Number of Servers
Retry Count at Activation Failure : 5
Retry Interval at Activation Failure : 5
Final Action at Activation Failure : No Operation (Not
activate next resource)
Execute Script before Final Action : Off
Retry Count at Deactivation Failure : 0
Retry Interval at Deactivation Failure : 5
Final Action at Deactivation Failure : Stop the cluster
service and shut down OS
Execute Script before Final Action : Off
Dependent Resources :
IP Address           : 1.1.1.1                -> see (1)
VPC ID               : vpc-00000000          -> see (2)
ENI ID               : eni-00000000         -> see (3)
AWS CLI Timeout(sec) : 60                   -> see(4)
=====
```

Explanation of each item

- (1) IP Address : VIP address to use
- (2) VPC ID : VPC ID to which the server belongs
- (3) ENI ID : ENI ID of the routing destination of the IVIP
- (4) AWS CLI Timeout(sec) : Time out of the AWS CLI

Example of a command entry (for Azure probe port resources)

```
# clpstat --rsc azurepp1 --detail
```

Example of the display after running the command:

```
===== CLUSTER INFORMATION =====
[Resource 0 : azurepp1]
  Type                : azurepp
  Comment              :
  Failover Target Server : stable operation server
  Failover Threshold   : Number of Servers
  Retry Count at Activation Failure : 5
  Retry Interval at Activation Failure : 5
  Final Action at Activation Failure : No Operation (Not
activate next resource)
  Execute Script before Final Action : Off
  Retry Count at Deactivation Failure : 0
  Retry Interval at Deactivation Failure : 5
  Final Action at Deactivation Failure : Stop the cluster
service and shut down OS
Execute Script before Final Action: Off
  Dependent Resources :
  Probe Port           : 8080 -> see (1)
  Probe Timeout (sec) : 30 -> see (2)
=====
```

Explanation of each item

- (1) Probe Port: Probe port
- (2) Probe Timeout (sec) : Probe wait timeout

◆ Tips

By using the `--grp` option and the `--rsc` option together, you can display the information as follows.

Command Line # `clpstat --grp --rsc`

```
===== CLUSTER INFORMATION =====
[Group0 : ManagementGroup]
  Comment :
  [Resource0 : ManagementIP]
    Type : fip
    Comment :
    IP Address : 10.0.0.10
[Group1 : failover1]
  Comment : failover group1
  [Resource0 : fip1]
    Type : fip
    Comment : 10.0.0.11
    IP Address : 10.0.0.11
  [Resource1 : md1]
    Type : md
    Comment : I:
    Mirror Disk No. : 1
    Drive Letter : I:
  [Resource2 : script1]
    Type : script
    Comment : script resource1
    Start Path : start.bat
    Stop Path : stop.bat
[Group2 : failover2]
  Comment : failover group2
  [Resource0 : fip2]
    Type : fip
    Comment : 10.0.0.12
    IP Address : 10.0.0.12
  [Resource1 : md2]
    Type : md
    Comment : J:
    Mirror Disk No. : 2
    Drive Letter : J:
  [Resource2 : script2]
    Type : script
    Comment : script resource2
    Start Path : start.bat
    Stop Path : stop.bat
=====
```

Displaying only the data of a certain monitor resource (--mon option)

When you want to display only the cluster configuration data on a specified monitor resource, specify the name of the monitor resource after the `--mon` option in the `clpstat` command. If you want to see the details, specify `--detail` option. When a monitor resource name is not specified, the configuration data of all the monitor resources is displayed.

Example of a command entry (For floating IP monitor resource)

```
# clpstat --mon fipw1 --detail
```

Example of the display after running the command:

```
===== CLUSTER INFORMATION =====
[Monitor0 : fipw1]
Type : fipw
Comment : fip1
Monitor Timing : Active
Target Resource : fip1
Interval : 60
Timeout : 60
Retry Count : 1
Final Action : No Operation
Execute Script before Reactivation: Off
Execute Script before Failover: Off
Execute Script before Final Action: Off
Recovery Target : failover1
Recovery Target Type : Group
Recovery Script Threshold : 0
Reactivation Threshold : 3
Failover Target Server : Stable operation server
Failover Threshold : Number of Servers
Wait Time to Start Monitoring : 0
Collect Dump at Timeout Occurrence: Off
Run Migration Before Run Failover: Off
Dummy Failure Possibility : Possible
Monitor NIC Link Up/Down : Enable
```

- ◆ The items marked by the solid line are common to all resources.
- ◆ The items marked by the dotted line are displayed when the `--detail` option is used.

Explanation of items common to all monitor resources

- (1) [MONITOR n: *monitor_resource_name*] (n is the identification number of the group)
- (2) Type : Monitor resource type
- (3) Comment : Comment
- (4) Monitor Timing : Timing to start monitoring
 - Always
 - Active
- (5) Target Resource : Monitor target resource
- (6) Interval : Monitor interval
- (7) Timeout : Monitor time-out (in seconds)

- (8) Retry Count : Monitor retry count
- (9) Final Action : Action taken when the retry count exceeds
 - No Operation
 - Stop Resoruce
 - Stop Group
 - Stop the cluster service
 - Stop the cluster service and shutdown OS
 - Stop cluster service and reboot OS
 - Generate an Intentional Stop Error
- (10) Execute Script before Reactivation : Whether or not to execute script before reactivation
- (11) Execute Script before Failover : Whether or not to execute script before failover
- (12) Execute Script before Final Action : Whether or not to execute script before final action
- (13) Recovery Target : Target to be recovered when an error is detected
- (14) Recovery Target Type : Type of a target to be recovered when an error is detected
 - Group
 - Resource
 - Itself
- (15) Recovery Script Threshold : Recovery script execution count
- (16) Reactivation Threshold : Restart count
- (17) Failover Target Server : Failover target server
 - The most prioritized server
 - Stable operation server
- (18) Failover Threshold : Failover count
- (19) Wait Time to Start Monitoring: Time to wait for the start of monitoring
- (20) Collect Dump at Timeout Occurrence: Whether or not to collect dump at timeout occurrence
- (21) Run Migration Before Run Failover: Whether or not to run migration before run failover
- (22) Dummy Failure Possibility: Enable dummy failure or not

Explanation of each item

- (23) Monitor NIC Link Up/Down : Monitor NIC Link Up/Down/Do not monitor NIC Link Up/Down

Example of a command entry (For virtual IP monitor resource)

```
# clpstat --mon vipw1 --detail
```

Example of the display after running the command:

```
===== CLUSTER INFORMATION =====
[Monitor0 : vipw1]
Type : vipw
Comment : vip1
Monitor Timing : Active
Target Resource : vip1
Interval : 60
Timeout : 60
Retry Count : 1
Final Action : No Operation
Execute Script before Reactivation: Off
Execute Script before Failover: Off
Execute Script before Final Action: Off
Recovery Target : failover1
Recovery Target Type : Group
Recovery Script Threshold : 0
Reactivation Threshold : 3
Failover Target Server : stable operation server
Failover Threshold : Number of Servers
Wait Time to Start Monitoring : 0
Collect Dump at Timeout Occurrence: Off
Run Migration Before Run Failover: Off
Dummy Failure Possiblity : Possible
=====
```

Explanation of each item

There is no item specific to virtual IP monitor resource.

Example of a command entry (For virtual computer name monitor resource)

```
# clpstat --mon vcomw1 --detail
```

Example of the display after running the command:

```
===== CLUSTER INFORMATION =====
[Monitor0 : vcomw1]
  Type                : vcomw
  Comment              : vcom1
  Monitor Timing      : Active
  Target Resource     : vcom1
  Interval            : 60
  Timeout             : 60
  Retry Count         : 1
  Final Action        : Stop the cluster service and shut
                      down OS
  Execute Script before Reactivation: Off
  Execute Script before Failover: Off
  Execute Script before Final Action: Off
  Recovery Target     : cluster
  Recovery Target Type : Itself
  Recovery Script Threshold : 0
  Reactivation Threshold : 0
  Failover Target Server : stable operation server
  Failover Threshold   : 0
  Wait Time to Start Monitoring : 0
  Collect Dump at Timeout Occurrence: Off
  Run Migration Before Run Failover: Off
  Dummy Failure Possibility : Possible
=====
```

Explanation of each item

There is no item specific to virtual computer name monitor resource.

Example of a command entry (For disk TUR monitor resource)

```
# clpstat --mon sdw1 --detail
```

Example of the display after running the command:

```
===== CLUSTER INFORMATION =====
[Monitor0 : sdw1]
Type : sdw
Comment :
Monitor Timing : Always
Target Resource :
Interval : 60
Timeout : 300
Retry Count : 0
Final Action : No Operation
Execute Script before Reactivation: Off
Execute Script before Failover: Off
Execute Script before Final Action: Off
Recovery Target : failover1
Recovery Target Type : Group
Recovery Script Threshold : 0
Reactivation Threshold : 0
Failover Target Server : stable operation server
Failover Threshold : Number of Servers
Wait Time to Start Monitoring : 0
Collect Dump at Timeout Occurrence: Off
Run Migration Before Run Failover: Off
Dummy Failure Possiblity : Possible
Disk Resource : sd1 -> see (1)
=====
```

Explanation of each item

(1) Disk Resource : Target disk resource name

Example of a command entry (For disk RW monitor resource)

```
# clpstat --mon diskw1 --detail
```

Example of the display after running the command:

```
===== CLUSTER INFORMATION =====
[Monitor0 : diskw1]
Type : diskw
Comment :
Monitor Timing : Always
Target Resource :
Interval : 30
Timeout : 300
Retry Count : 0
Final Action : No Operation
Execute Script before Reactivation: Off
Execute Script before Failover: Off
Execute Script before Final Action: Off
Recovery Target : failover1
Recovery Target Type : Group
Recovery Script Threshold : 0
Reactivation Threshold : 0
Failover Target Server : stable operation server
Failover Threshold : Number of Servers
Wait Time to Start Monitoring : 0
Collect Dump at Timeout Occurrence: Off
Run Migration Before Run Failover: Off
Dummy Failure Possibility : Possible
File Name : C:\a.txt -> see (1)
I/O Size (byte) : 2000000 -> see (2)
Action on Stall : STOP Error -> see (3)
Action When Diskfull is Detected : Execute Recovery Action -> see (4)
Use Write Through Method : Disabled -> see (5)
=====
```

Explanation of each item

- (1) File Name : File name
- (2) I/O size (byte) : I/O size (in bytes)
- (3) Action on Stall : Actions taken when an stall is detected
- (4) Action When Diskfull is Detected : Action when disk full is detected
- (5) Use Write Through Method : Enable/disable use of the Write Through method

Example of a command entry (For mirror disk monitor resource)

```
# clpstat --mon mdw1 --detail
```

Example of the display after running the command:

```
===== CLUSTER INFORMATION =====
[Monitor0 : mdw1]
  Type : mdw
  Comment :
  Monitor Timing : Always
  Target Resource :
  Interval : 30
  Timeout : 999
  Retry Count : 1
  Final Action : No Operation
  Execute Script before Reactivation: Off
  Execute Script before Failover: Off
  Execute script Before Final Action: Off
  Recovery Target : md1
  Recovery Target Type : Resource
  Recovery Script Threshold : 0
  Reactivation Threshold : 0
  Failover Target Server : stable operation server
  Failover Threshold : Number of Servers
  Wait Time to Start Monitoring : 0
  Collect Dump at Timeout Occurrence: Off
  Run Migration Before Run Failover: Off
  Dummy Failure Possiblity : Possible
  Mirror Disk Resource Name : md1 -> see (1)
=====
```

Explanation of each item

- (1) Mirror Disk Resource Name : Target mirror disk resource name

Example of a command entry (For mirror connect monitor resource)

```
# clpstat --mon mdnw1 --detail
```

Example of the display after running the command:

```
===== CLUSTER INFORMATION =====
[Monitor0 : mdnw1]
Type : mdnw
Comment :
Monitor Timing : Always
Target Resource :
Interval : 60
Timeout : 10
Retry Count : 0
Final Action : No Operation
Execute Script before Reactivation: Off
Execute Script before Failover: Off
Execute Script before Final Action: Off
Recovery Target : md1
Recovery Target Type : Resource
Recovery Script Threshold : 0
Reactivation Threshold : 0
Failover Target Server : stable operation server
Failover Threshold : 0
Wait Time to Start Monitoring : 0
Collect Dump at Timeout Occurrence: Off
Run Migration Before Run Failover: Off
Dummy Failure Possiblity : Possible
Mirror Disk Resource Name : md1 -> see (1)
=====
```

Explanation of each item

- (1) Mirror Disk Resource Name : Target mirror disk resource name

Example of a command entry (For print spooler monitor resource)

```
# clpstat --mon spoolw1 --detail
```

Example of the display after running the command:

```
===== CLUSTER INFORMATION =====
[Monitor0 : spoolw1]
Type : spoolw
Comment : spool1
Monitor Timing : Active
Target Resource : spool1
Interval : 60
Timeout : 60
Retry Count : 1
Final Action : No Operation
Execute Script before Reactivation: Off
Execute Script before Failover: Off
Execute Script before Final Action: Off
Recovery Target : failover1
Recovery Target Type : Group
Recovery Script Threshold : 0
Reactivation Threshold : 3
Failover Target Server : stable operation server
Failover Threshold : Number of Servers
Wait Time to Start Monitoring : 0
Collect Dump at Timeout Occurrence: Off
Run Migration Before Run Failover: Off
Dummy Failure Possiblity : Possible
=====
```

Explanation of each item

There is no item specific to print spooler monitor resources.

Example of a command entry (For registry synchronization monitor resource)

```
# clpstat --mon regsyncw1 --detail
```

Example of the display after running the command:

```
===== CLUSTER INFORMATION =====
[Monitor0 : regsyncw1]
Type : regsyncw
Comment : regsync1
Monitor Timing : Active
Target Resource : regsync1
Interval : 60
Timeout : 60
Retry Count : 1
Final Action : No Operation
Execute Script before Reactivation: Off
Execute Script before Failover: Off
Execute Script before Final Action: Off
Recovery Target : failover1
Recovery Target Type : Group
Recovery Script Threshold : 0
Reactivation Threshold : 3
Failover Target Server : stable operation server
Failover Threshold : Number of Servers
Wait Time to Start Monitoring : 0
Collect Dump at Timeout Occurrence: Off
Run Migration Before Run Failover: Off
Dummy Failure Possiblity : Possible
=====
```

Explanation of each item

There is no item specific to registry synchronous monitor resources.

Example of a command entry (For application monitor resource)

```
# clpstat --mon appliw1 --detail
```

Example of the display after running the command:

```
===== CLUSTER INFORMATION =====
[Monitor0 : appliw1]
Type : appliw
Comment : appli1
Monitor Timing : Active
Target Resource : appli1
Interval : 60
Timeout : 60
Retry Count : 1
Final Action : No Operation
Execute Script before Reactivation: Off
Execute Script before Failover: Off
Execute Script before Final Action: Off
Recovery Target : failover1
Recovery Target Type : Group
Recovery Script Threshold : 0
Reactivation Threshold : 3
Failover Target Server : stable operation server
Failover Threshold : Number of Servers
Wait Time to Start Monitoring : 0
Collect Dump at Timeout Occurrence: Off
Run Migration Before Run Failover: Off
Dummy Failure Possiblity : Possible
=====
```

Explanation of each item

There is no item specific to application monitor resources.

Example of a command entry (For service monitor resource)

```
# clpstat --mon servicew1 --detail
```

Example of the display after running the command:

```
===== CLUSTER INFORMATION =====
[Monitor0 : servicew1]
Type : servicew
Comment : servicew1
Monitor Timing : Active
Target Resource : servicew1
Interval : 60
Timeout : 60
Retry Count : 1
Final Action : No Operation
Execute Script before Reactivation: Off
Execute Script before Failover: Off
Execute Script before Final Action: Off
Recovery Target : failover1
Recovery Target Type : Group
Recovery Script Threshold : 0
Reactivation Threshold : 3
Failover Target Server : stable operation server
Failover Threshold : Number of Servers
Wait Time to Start Monitoring : 0
Collect Dump at Timeout Occurrence: Off
Run Migration Before Run Failover: Off
Dummy Failure Possibility : Possible
=====
```

Explanation of each item

There is no item specific to service monitor resources.

Example of a command entry (For IP monitor resource)

```
# clpstat --mon ipw1 --detail
```

Example of the display after running the command:

```
===== CLUSTER INFORMATION =====
[Monitor0 : ipw1]
  Type                : ipw
  Comment             :
  Monitor Timing      : Always
  Target Resource     :
  Interval            : 60
  Timeout             : 60
  Retry Count         : 1
  Final Action        : No Operation
  Execute Script before Reactivation: Off
  Execute Script before Failover: Off
  Execute Script before Final Action: Off
  Recovery Target     : failover1
  Recovery Target Type : Group
  Recovery Script Threshold : 0
  Reactivation Threshold : 3
  Failover Target Server : stable operation server
  Failover Threshold   : Number of Servers
  Wait Time to Start Monitoring : 0
  Collect Dump at Timeout Occurrence: Off
  Run Migration Before Run Failover: Off
  Dummy Failure Possiblity : Possible
  IP Addresses        : 10.0.0.254      -> see (1)
                    : 10.0.0.253
  Ping Timeout (msec) : 1000          -> see (2)
=====
```

Explanation of each item

- (1) IP Addresses : Monitor Target IP Addresses
- (2) Ping Timeout (msec) : ping time-out time (in milliseconds)

Example of a command entry (For NIC Link Up/Down monitor resource)

```
# clpstat --mon miiw1 --detail
```

Example of the display after running the command:

```
===== CLUSTER INFORMATION =====
[Monitor0 : miiw1]
Type : miiw
Comment :
Monitor Timing : Always
Target Resource :
Interval : 60
Timeout : 60
Retry Count : 1
Final Action : No Operation
Execute Script before Reactivation: Off
Execute Script before Failover: Off
Execute Script before Final Action: Off
Recovery Target : cluster
Recovery Target Type : Itself
Recovery Script Threshold : 0
Reactivation Threshold : 0
Failover Target Server : stable operation server
Failover Threshold : 0
Wait Time to Start Monitoring : 0
Collect Dump at Timeout Occurrence: Off
Run Migration Before Run Failover: Off
Dummy Failure Possiblity : Possible
=====
```

Explanation of each item

There is no item specific to NIC Link Up/down monitor resources.

Example of a command entry (For multi target monitor resource)

```
# clpstat --mon mtw1 --detail
```

Example of the display after running the command:

```
===== CLUSTER INFORMATION =====
[Monitor0 : mtw1]
Type : mtw
Comment :
Monitor Timing : Always
Target Resource :
Interval : 60
Timeout : 60
Retry Count : 1
Final Action : No Operation
Execute Script before Reactivation: Off
Execute Script before Failover: Off
Execute Script before Final Action: Off
Recovery Target : failover1
Recovery Target Type : Group
Recovery Script Threshold : 0
Reactivation Threshold : 3
Failover Target Server : stable operation server
Failover Threshold : Number of Servers
Wait Time to Start Monitoring : 0
Collect Dump at Timeout Occurrence: Off
Run Migration Before Run Failover: Off
Dummy Failure Possiblity : Possible
Monitor Resources : appliwl -> see (1)
                  : fipwl
=====
```

Explanation of each item

(1) Monitor Resources : Monitor resources to be grouped

Example of a command entry (For cifs monitor resource)

```
# clpstat --mon cifsw1 --detail
```

Example of the display after running the command:

```
===== CLUSTER INFORMATION =====
[Monitor0 : cifsw1]
Type : cifsw
Comment :
Monitor Timing : Actice
Target Resource : cifsw1
Interval : 60
Timeout : 60
Retry Count : 1
Final Action : No Operation
Execute Script before Reactivation: Off
Execute Script before Failover: Off
Execute Script before Final Action: Off
Recovery Target : cifsw1
Recovery Target Type : Resource
Recovery Script Threshold : 0
Reactivation Threshold : 3
Failover Target Server : stable operation server
Failover Threshold : Number of Servers
Wait Time to Start Monitoring : 0
Collect Dump at Timeout Occurrence: Off
Run Migration Before Run Failover: Off
Dummy Failure Possiblity : Possible
Access Check : no check -> see (1)
Check Path : -> see (2)
Check Method : Read -> see (3)
=====
```

Explanation of each item

- (1) Access Check : Specify the way to check access to the shared folders
- (2) Check Path : Specify the file/folder for access check by using a relative path from the shared folder
- (3) Check Method : Select the way to check the access for **File Check**

Example of a command entry (For hybrid disk monitor resource)

```
# clpstat --mon hdw1 --detail
```

Example of the display after running the command:

```
===== CLUSTER INFORMATION =====
[Monitor0 : hdw1]
Type : hdw
Comment :
Monitor Timing : Always
Target Resource :
Interval : 30
Timeout : 999
Retry Count : 1
Final Action : No Operation
Execute Script before Reactivation: Off
Execute Script before Failover: Off
Execute Script before Final Action: Off
Recovery Target : hd
Recovery Target Type : Resource
Recovery Script Threshold : 0
Reactivation Threshold : 0
Failover Target Server : stable operation server
Failover Threshold : Number of Servers
Wait Time to Start Monitoring : 10
Collect Dump at Timeout Occurrence: Off
Run Migration Before Run Failover: Off
Dummy Failure Possiblity : Impossible
=====
```

Explanation of each item

There is no item specific to hybrid disk monitor resources.

Example of a command entry (For hybrid disk TUR monitor resource)

```
# clpstat --mon hdtw1 --detail
```

Example of the display after running the command:

```
===== CLUSTER INFORMATION =====
[Monitor0 : hdtw1]
Type : hdtw
Comment :
Monitor Timing : Always
Target Resource :
Interval : 30
Timeout : 300
Retry Count : 1
Final Action : No Operation
Execute Script before Reactivation: Off
Execute Script before Failover: Off
Execute Script before Final Action: Off
Recovery Target : hd
Recovery Target Type : Resource
Recovery Script Threshold : 0
Reactivation Threshold : 0
Failover Target Server : stable operation server
Failover Threshold : Number of Servers
Wait Time to Start Monitoring : 0
Collect Dump at Timeout Occurrence: Off
Run Migration Before Run Failover: Off
Dummy Failure Possiblity : Possible
Hybrid Disk Resource : hd -> see (1)
=====
```

Explanation of each item

- (1) Hybrid Disk Resource : Hybrid disk resource to be monitored

Example of a command entry (For message receive monitor resource)

```
# clpstat --mon mrw1 --detail
```

Example of the display after running the command:

```
===== CLUSTER INFORMATION =====
[Monitor0 : mrw1]
  Type                : mrw
  Comment              :
  Monitor Timing      : Always
  Target Resource     :
  Interval            : 10
  Timeout             : 30
  Retry Count         : 0
  Final Action        : No Operation
  Execute Script before Reactivation: Off
  Execute Script before Failover: Off
  Execute Script before Final Action: Off
  Recovery Target     : failover1
  Recovery Target Type : Group
  Recovery Script Threshold : 0
  Reactivation Threshold : 0
  Failover Target Server : stable operation server
  Failover Threshold  : Number of Servers
  Wait Time to Start Monitoring : 0
Collect Dump at Timeout Occurrence: Off
  Run Migration Before Run Failover: Off
  Dummy Failure Possibility : Impossible
  keyword              : -> see (1)
  category             : -> see (2)
  Execute Failover to outside the Server Group: Off -> see (3)
=====
```

Explanation of each item

- (1) keyword : Specify the keyword specified with -k argument of clprexec command.
- (2) category : Specify the category specified with -k argument of clprexec command.
- (3) Execute Failover to outside the Server Group:
Failover a group outside of the server group or not.

Example of a command entry (For multi target monitor resource)

```
# clpstat --mon vmw1 --detail
```

Example of the display after running the command:

```
===== CLUSTER INFORMATION =====
[Monitor0 : vmw1]
Type : vmw
Comment :
Monitor Timing : Active
Target Resource : vm1
Interval : 60
Timeout : 60
Retry Count : 1
Final Action : No Operation
Execute Script before Reactivation: Off
Execute Script before Failover: Off
Execute Script before Final Action: Off
Recovery Target : vm1
Recovery Target Type : Resource
Recovery Script Threshold : 0
Reactivation Threshold : 3
Failover Target Server : stable operation server
Failover Threshold : Number of Servers
Wait Time to Start Monitoring : 0
Collect Dump at Timeout Occurrence: Off
Run Migration Before Run Failover: Off
Dummy Failure Possiblity : Impossible
VM Resource Name : vm1 -> see (1)
=====
```

Explanation of each item

- (1) VM Resource Name : Name of the VM resource

Example of a command entry (For a system monitor resource)

```
# clpstat --mon sraw --detail
```

Example of the display after running the command

```
===== CLUSTER INFORMATION =====
[Monitor1 : sraw]
Type : sraw
Comment :
Monitor Timing : Always
Target Resource :
Interval : 30
Timeout : 60
Retry Count : 0
Final Action : No Operation
Execute Script before Final Action : Off
Recovery Target : [All Groups]
Recovery Target Type : Group
Reactivation Threshold : 0
Failover Target Server : Stable Server
Failover Threshold : Number of Servers
Wait Time to Start Monitoring : 0
Collect Dump at Timeout Occurrence : Off
Run Migration Before Run Failover : Off
Dummy Failure Possiblity : Impossible
System: Monitoring CPU Usage : On -> see (1)
System: CPU Rate (%) : 90 -> see (2)
System: CPU Monitoring Duration (sec): 3600 -> see (3)
System: Monitoring Memory Usage : On -> see (4)
System: Memory Usage Rate (%) : 90 -> see (5)
System: Memory Usage Monitoring Duration (sec): 3600 -> see (6)
System: Monitoring Virtual Memory Usage: On -> see (7)
System: Virtual Memory Usage Rate (%): 90 -> see (8)
System: Virtual Memory Usage Monitoring Duration (sec) : 3600 -> see (9)
Process: Monitoring CPU Usage : On -> see (10)
Process: Monitoring Memory Leak : On -> see (11)
Process: Monitoring File Leak : On -> see (12)
Process: Monitoring Thread Leak : On -> see (13)
Process: Monitoring Same Name Process Count: On -> see (14)
Disk: Logical Drive -> see (15)
=====
```

Explanation of each item

- (1) Monitoring CPU Usage : Monitoring CPU usage error
- (2) CPU Rate (%) : Threshold for detecting a CPU usage error
- (3) CPU Monitoring Duration (sec) : Time during which to detect a CPU usage error
- (4) Monitoring Memory Usage : Monitoring memory usage error
- (5) Memory Usage Rate (%) : Threshold for detecting a memory usage error

- (6) Memory Usage Monitoring Duration (sec)
: Time during which to detect a total memory usage error
- (7) Monitoring Virtual Memory Usage
: Monitoring virtual memory usage error
- (8) Virtual Memory Usage Rate (%)
: Threshold for detecting a virtual memory usage error
- (9) Virtual Memory Usage Monitoring Duration (sec)
: Time during which to detect a total virtual memory usage error
- (10) Monitoring CPU Usage
: Monitoring CPU usage error
- (11) Monitoring Memory Leak
: Monitoring memory leak error
- (12) Monitoring File Leak
: Monitoring file leak error
- (13) Monitoring Thread Leak
: Monitoring thread leak error
- (14) Monitoring Same Name Process Count
: Monitoring number of same name process error
- (15) Logical Drive
: Logical Drive

Example of a command entry (For dynamic DNS monitor resource)

```
# clpstat --mon ddns1 --detail
```

Example of the display after running the command

```
===== CLUSTER INFORMATION =====
[Monitor0 : ddns1]
Type : ddnsw
Comment :
Monitor Timing : Active
Target Resource : ddns1
Interval : 60
Timeout : 60
Retry Count : 1
Final Action : Stop the cluster service and
                shutdown OS
Execute Script before Reactivation : Off
Execute Script before Failover : Off
Execute Script before Final Action : Off
Recovery Target : cluster
Recovery Target Type : Itself
Recovery Script Threshold : 0
Reactivation Threshold : 0
Failover Target Server : stable operation server
Failover Threshold : 0
Wait Time to Start Monitoring : 0
Collect Dump at Timeout Occurrence : Off
Run Migration Before Run Failover : Off
Dummy Failure Possibility : Impossible
DNS query check : On (1)
```

Explanation of each item

(1) DNS query check : Whether to ask the DDNS server if name resolution is available.

Example of a command entry (for AWS elastic ip monitor resources)

```
# clpstat --mon awseipw1 --detail
```

Example of the display after running the command

```
===== CLUSTER INFORMATION =====
[Monitor0 : awseipw1]
  Type                : awseipw
  Comment             :
  Monitor Timing      : Active
  Target Resource     : awseip1
  Interval            : 60
  Timeout             : 60
  Retry Count         : 1
  Final Action        : No Operation
  Execute Script before Reactivation : Off
  Execute Script before Failover     : Off
  Execute Script before Final Action  : Off
  Recovery Target     : failover1
  Recovery Target Type : Group
  Recovery Script Threshold : 0
  Reactivation Threshold : 3
  Failover Target Server : Stable operation server
  Failover Threshold   : Number of Servers
  Wait Time to Start Monitoring : 0
  Collect Dump at Timeout Occurrence : Off
  Run Migration before Run Failover  : Off
  Dummy Failure Possibility          : Possible
  Action when AWS CLI command failed to receive response : Disable recovery

action(Display warning)-> see (1)
=====
```

Explanation of each item

(1) Action when AWS CLI command failed to receive response: Action when AWS CLI command failed to receive response

Example of a command entry (for AWS virtual ip monitor resources)

```
# clpstat --mon awsvipw1 --detail
```

Example of the display after running the command

```
===== CLUSTER INFORMATION =====
[Monitor0 : awsvipw1]
Type : awsvipw
Comment :
Monitor Timing : Active
Target Resource : awsvipw1
Interval : 60
Timeout : 60
Retry Count : 1
Final Action : No Operation
Execute Script before Reactivation : Off
Execute Script before Failover : Off
Execute Script before Final Action : Off
Recovery Target : failover1
Recovery Target Type : Group
Recovery Script Threshold : 0
Reactivation Threshold : 3
Failover Target Server : Stable operation server
Failover Threshold : Number of Servers
Wait Time to Start Monitoring : 0
Collect Dump at Timeout Occurrence : Off
Run Migration before Run Failover : Off
Dummy Failure Possibility : Possible
Action when AWS CLI command failed to receive response : Disable recovery

action (Display warning) -> see (1)
=====
```

Explanation of each item

(1) Action when AWS CLI command failed to receive response: Action when AWS CLI command failed to receive response

Example of a command entry (for AWS AZ monitor resources)

```
# clpstat --mon awsazw1 --detail
```

Example of the display after running the command

```
===== CLUSTER INFORMATION =====
[Monitor0 : awsazw1]
  Type                : awsazw
  Comment              :
  Monitor Timing      : Active
  Target Resource     : aws1
  Interval             : 60
  Timeout             : 60
  Retry Count         : 1
  Final Action        : No Operation
  Execute Script before Reactivation : Off
  Execute Script before Failover     : Off
  Execute Script before Final Action  : Off
  Recovery Target      : failover1
  Recovery Target Type : Group
  Recovery Script Threshold : 0
  Reactivation Threshold : 3
  Failover Target Server : stable operation server
  Failover Threshold    : Number of Servers
  Wait Time to Start Monitoring : 0
  Collect Dump at Timeout Occurrence : Off
  Run Migration before Run Failover  : Off
  Dummy Failure Possibility          : Possible
  Availability Zone                   : ap-northeast-1a-> see (1)
  Action when AWS CLI command failed to receive response : Disable recovery
```

action(Display warning)-> see (2)

Explanation of each item

- (1) Availability Zone: Availability zone
- (2) Action when AWS CLI command failed to receive response: Action when AWS CLI command failed to receive response

Example of a command entry (for Azure probe port monitor resources)

```
# clpstat --mon azureppw1 --detail
```

Example of the display after running the command

```
===== CLUSTER INFORMATION =====
[Monitor0 : azureppw1]
Type : azureppw
Comment :
Monitor Timing : Active
Target Resource : azurepp1
Interval : 60
Timeout : 60
Retry Count : 1
Final Action : No Operation
Execute Script before Reactivation : Off
Execute Script before Failover : Off
Execute Script before Final Action : Off
Recovery Target : failover1
Recovery Target Type : Group
Recovery Script Threshold : 0
Reactivation Threshold : 3
Failover Target Server : Stable operation server
Failover Threshold : Number of Servers
Wait Time to Start Monitoring : 0
Collect Dump at Timeout Occurrence : Off
Run Migration before Run Failover : Off
Dummy Failure Possibility : Possible
Action when Probe port wait timeout : Disable recovery

action (Display warning) -> see (1)
=====
```

Explanation of each item

(1) Action when Probe port wait timeout: Action when Probe port wait timeout

Example of a command entry (for Azure load balance monitor resources)

```
# clpstat --mon azurelbw1 --detail
```

Example of the display after running the command

```
===== CLUSTER INFORMATION =====
[Monitor0 : azurelbw1]
Type : azurelbw
Comment :
Monitor Timing : Always
Target Resource : azureppl
Interval : 60
Timeout : 60
Retry Count : 1
Final Action : No Operation
Execute Script before Reactivation : Off
Execute Script before Failover : Off
Execute Script before Final Action : Off
Recovery Target : failover1
Recovery Target Type : Group
Recovery Script Threshold : 0
Reactivation Threshold : 3
Failover Target Server : Stable operation server
Failover Threshold : Number of Servers
Wait Time to Start Monitoring : 0
Collect Dump at Timeout Occurrence : Off
Run Migration before Run Failover : Off
Dummy Failure Possibility : Possible
Monitor Target : azureppl -> see(1)
=====
```

Explanation of each item

(1) Monitor Target: Monitor target resource

Example of a command entry (For user space monitor resource)

```
# clpstat --mon userw1 --detail
```

Example of display after running the command:

```
===== CLUSTER INFORMATION =====
[Monitor0 : userw1]
Type : userw
Comment :
Monitor Timing : Active
Target Resource :
Interval : 30
Timeout : 300
Retry Count : 0
Final Action : No Operation
Execute Script before Reactivation : Off
Execute Script before Failover : Off
Execute Script before Final Action : Off
Recovery Target : failover1
Recovery Target Type : Group
Recovery Script Threshold : 0
Reactivation Threshold : 0
Failover Target Server : Stable operation server
Failover Threshold : Number of Servers
Wait Time to Start Monitoring : 0
Collect Dump at Timeout Occurrence : Off
Run Migration Before Run Failover : Off
Dummy Failure Possibility : Possible
Use Heartbeat Interval/Timeout : On (1)
Monitoring Method : keepalive (2)
Action When Timeout Occurs : STOP error (3)
Create a Dummy Thread : On (4)
=====
```

Explanation of each item

- (1) Use Heartbeat Interval/Timeout : Whether to enable the use of heartbeat interval/timeout
- (2) Monitoring Method : Method of monitoring the user space monitor resource
- (3) Action When Timeout Occurs : Action performed when a timeout occurs
- (4) Create a Dummy Thread : Whether or not to create a dummy thread

Displaying all cluster configuration data (-i option)

By specifying the `-i` option, you can display the configuration information that is shown when `--cl`, `--sv`, `--hb`, `--np`, `--svg`, `--grp`, `--rsc`, and `--mon` options are all specified.

If you run the command with the `-i` option and the `--detail` option together, all the detailed cluster configuration data is displayed.

Because this option displays large amount of information at a time, use a command, such as the `more` command, and pipe, or redirect the output in a file for the output.

Example of a command entry:

```
# clpstat -i
```

◆ Tips

Specifying the `-i` option displays all the information on a console. If you want to display some of the information, it is useful to combine the `--cl`, `--sv`, `--hb`, `--np`, `--svg`, `--grp`, `--rsc`, and/or `--mon` option. For example, you can use these options as follows:

Example of a command entry:

If you want to display the detailed information of the server whose name is “server0,” the group whose name is “failover1,” and the group resources of the specified group, enter:

```
# clpstat --sv server0 --grp failover1 --rsc --detail
```

Displaying the status of the cluster (--local option)

By specifying the --local option, you can display only information of the server on which you execute the clpstat command, without communicating with other servers.

Example of a command entry:

```
# clpstat --local
```

Example of display after running the command:

```
===== CLUSTER STATUS =====
Cluster : cluster -> See (1)
  cluster      : Start      cluster      -> See (2)
<server>
  *server1 .....: Online      server1      -> See (3)
    lankhb1     : Normal     LAN Heartbeat -> See (4)
    lankhb2     : Normal     LAN Heartbeat -> See (4)
    pingnp1     : Normal     ping resolution -> See (5)
  server2 .....: Online      server2
    lankhb1     : -          LAN Heartbeat
    lankhb2     : -          LAN Heartbeat
    pingnp1     : -          ping resolution
<group>
  ManagementGroup : Online      Management Group -> See (6)
    current       : server1
  ManagementIP    : Online      10.0.0.10
  failover1 .....: Online      failover group1 -> See (7)
    current       : server1
    fip1          : Online      10.0.0.11 -> See (8)
    md1           : Online      I:
    script1       : Online      script resource1
  failover2 .....: -          failover group2
    current       : server2
    fip2          : -          10.0.0.12
    md2           : -          J:
    script2       : -          script resource2
<monitor> -> See (9)
  fipw1          : Online      fip1 -> See (10)
  fipw2          : Online      fip2
  ipw1           : Online      ip monitor1
  mdnw1         : Online      md1
  mdnw2         : Online      md2
  mdw1          : Online      md1
  mdw2          : Online      md2
=====
```

Explanation of each item

- (1) Cluster : Cluster name
- (2) Cluster name : Status Cluster comment
- (3) Server name : Status Server comment
 "*" indicates the server has executed this command.
 The Suspension status is not displayed.
- (4) Heartbeat resource name : Status Heartbeat resource comment
 The heartbeat resource status of a server other than the server on which this command is executed is not displayed.

- (5) NP resolution resource name : Status NP resolution resource comment
The network partition resolution resource status of a server other than the server on which this command is executed is not displayed.
- (6) Management group name : Status Management group comment
current : Server name
Shows the server to which the group belongs now.
The status of the group that is running on a server other than the server on which this command is executed is not displayed.
- (7) Group name : Status Group comment
current : Server name
Shows the server to which the group belongs now.
The status of the group that is running on a server other than the server on which this command is executed is not displayed.
- (8) Group resource name : Status Group resource comment
The status of the resource that is running on a server other than the server on which this command is executed is not displayed.
- (9) The following descriptions are displayed after the monitor resource name.
 - If the monitor resource contains an error and the recovery action is restricted, "Recovery Action Disabled" is displayed.
 - If dummy failure occurred in the monitor resource, "Failure Verification" is displayed.
- (10) Monitor resource name : Status Monitor resource comment
If dummy failure occurred in the monitor resource, "(Dummy Failure)" is added after the status.

Information on each status is provided in "Status Descriptions" on page 341.

Status Descriptions

Cluster		
Function	Status	Description
Status display (--local)	Start	Starting
	Suspend	Being suspended
	Stop	Offline pending
	Unknown	Status unknown

Server		
Function	Status	Description
Status display	Online	Starting
Heartbeat resource status display	Offline	Offline pending
	Warning	Heartbeat resource failure
	Isolated	Suspension (isolated)
	Online Pending	Now being started
	Offline Pending	Now being stopped
	Pending	Suspension (Network partition unsolved)
	Unknown	Status unknown
	-	Status unknown
Group map display	o	Starting
Monitor resource status display	s	Suspension (isolated)
	p	Now being started/stopped, , Network partition unsolved
	x	Offline Pending
	-	Status unknown

Heartbeat Resource		
Function	Status	Description
Status display	Normal	Normal
	Warning	Failure (Some)
	Error	Failure (All)
	Not Used	Not used
	Unknown	Status unknown
	-	Status unknown
Heartbeat resource status display	o	Able to communicate
	x	Unable to communicate
	-	Not used or status unknown

Network Partition Resolution Resource		
Function	Status	Description
Status display	Normal	Normal
	Caution	Failure (Some)

	Error	Failure (All)
	Unused	Not used
	Unknown	Status unknown
	-	Status unknown
Network partition resolution resource status display	o	Able to communicate
	x	Unable to communicate
	-	Not used or status unknown

Group		
Function	Status	Description
Status display	Online	Started
	Offline	Stopped
	Online Pending	Now being started
	Offline Pending	Now being stopped
	Error	Error
	Unknown	Status unknown
	-	Status unknown
Group map display	o	Started
	e	Error
	p	Now being started/stopped

Group Resource		
Function	Status	Description
Status display	Online	Started
	Offline	Stopped
	Online Pending	Now being started
	Offline Pending	Now being stopped
	Online Failure	Starting failed
	Offline Failure	Stopping failed
	Unknown	Status unknown
	-	Status unknown

Monitor Resource		
Function	Status	Description
Status display	Normal	Normal
	Caution	Error (Some)
	Error	Error (All)
	Unused	Not Used
	Unknown	Status unknown
	Normal (Dummy Failure)	Normal (Dummy Failure)
	Caution (Dummy Failure)	Error (Some) (Dummy Failure)
	Error (Dummy Failure)	Error (All) (Dummy Failure)
Status display (--local)	Online	Started
Monitor resource status display	Offline	Stopped
	Caution	Warning
	Suspend	Stopped temporarily
	Online Pending	Now being started
	Offline Pending	Now being stopped
	Online Failure	Starting failed
	Offline Failure	Stopping failed
	Unused	Not used
	Unknown	Status unknown
	Online (Dummy Failure)	Started (Dummy Failure)
	Offline (Dummy Failure)	Stopped (Dummy Failure)
	Caution (Dummy Failure)	Warning (Dummy Failure)
	Suspend (Dummy Failure)	Stopped temporarily (Dummy Failure)
	Online Pending (Dummy Failure)	Now being started (Dummy Failure)
	Offline Pending (Dummy Failure)	Now being stopped (Dummy Failure)
	Online Failure (Dummy Failure)	Starting failed (Dummy Failure)
	Offline Failure (Dummy Failure)	Stopping failed (Dummy Failure)
	-	Status unknown

Operating the cluster (clpcl command)

clpcl: the `clpcl` command operates a cluster

Command line:

```
clpcl -s [-a] [-h hostname]
clpcl -t [-a] [-h hostname] [-w time-out] [--apito time-out]
clpcl -r [-a] [-h hostname] [-w time-out] [--apito time-out]
clpcl -return [-h hostname] [--apito time-out]
clpcl -suspend [--force] [-w time-out] [--apito time-out]
clpcl -resume
```

Description	This command starts, stops, return, suspends, or resumes the EXPRESSCLUSTER service.	
Option	<p><code>-s</code></p> <p><code>-t</code></p> <p><code>-r</code></p> <p><code>--return</code></p> <p><code>--suspend</code></p> <p><code>--resume</code></p> <p><code>-a</code></p> <p><code>-h</code> <i>host_name</i></p> <p><code>-w</code> <i>time-out</i></p> <p><code>--force</code></p> <p><code>--apito</code> <i>time-out</i></p>	<p>Starts the EXPRESSCLUSTER service.</p> <p>Stops the EXPRESSCLUSTER service.</p> <p>Restarts the EXPRESSCLUSTER service.</p> <p>Restores a server that is in the suspension (isolated) status to the normal status.</p> <p>Suspends the entire cluster</p> <p>Resumes the entire cluster</p> <p>Executed the command on all servers</p> <p>Makes a request to run the command to the server specified in <i>host_name</i>. Makes a processing request to the server on which this command runs (local server) if the <code>-h</code> option is omitted.</p> <p>When <code>-t</code>, <code>-r</code>, or <code>--suspend</code> option is used, specify the wait time in seconds that the <code>clpcl</code> command waits for the EXPRESSCLUSTER service to be completely stopped or suspended.</p> <p>When a <code>time-out</code> is not specified, it waits for unlimited time.</p> <p>When “0 (zero)” is specified, it does not wait.</p> <p>When the <code>-w</code> option is not specified, it waits for twice the heartbeat <code>time-out</code> (in seconds).</p> <p>When used with the <code>--suspend</code> option, forcefully suspends the cluster regardless of the status of all the servers in the cluster.</p> <p>Specify the time in seconds to wait for the EXPRESSCLUSTER service to be stopped, restarted, or suspended (internal communication timeout). A value between 1 to 9999 can be specified.</p> <p>When the <code>--apito</code> option is not specified, the command waits according to the value set for the internal communication timeout in the cluster</p>

		property.
Return Value	0	Success
	Other than 0	Failure
Remarks	<p>When this command is executed with the <code>-s</code> or <code>--resume</code> option specified, it returns control when processing starts on the target server.</p> <p>When this command is executed with the <code>-t</code> or <code>--suspend</code> option specified, it returns control after waiting for the processing to complete.</p> <p>When this command is executed with the <code>-r</code> option specified, it returns control when the EXPRESSCLUSTER daemon restarts on the target server after stopping once.</p> <p>Run the <code>clpstat</code> command to display the started or resumed status of the EXPRESSCLUSTER daemon.</p>	
Notes	<p>Run this command as a user with Administrator privileges.</p> <p>This command cannot be executed while a group is being started or stopped.</p> <p>For the name of a server for the <code>-h</code> option, specify the name of a server in the cluster that allows name resolution.</p> <p>When you suspend the cluster, the EXPRESSCLUSTER service should be activated in all servers in the cluster. When the <code>--force</code> option is used, the cluster is forcefully suspended even if there is any stopped server in the cluster.</p> <p>When you start up or resume the cluster, access the servers in the cluster in the order below, and use one of the paths that allowed successful access.</p> <ol style="list-style-type: none"> 1. via the IP address on the interconnect LAN 2. via the IP address on the public LAN 3. via the IP address whose name was resolved by the server name in the cluster configuration data <p>When you resume the cluster, use the <code>clpstat</code> command to see there is no activated server in the cluster.</p>	
Example of a command entry	<p>Example 1: Activating the EXPRESSCLUSTER service in the local server</p> <pre># clpcl -s</pre> <p>Command succeeded</p> <p>Example 2: Activating the EXPRESSCLUSTER service in server1 from server0</p> <pre># clpcl -s -h server1</pre> <p>Start server1 : Command succeeded.</p> <p>If a server name is specified, the display after running the command should look similar to above.</p> <pre>Start server_name : Execution result</pre> <p>Example 3: Activating the EXPRESSCLUSTER service in all servers</p> <pre># clpcl -s -a</pre>	

Start server0 : Command succeeded.

Start server1 : Performed startup processing to the active cluster service.

When all the servers are activated, the display after running the command should look similar to above.

Start server_name : Execution result

Example 4: Stopping the EXPRESSCLUSTER service in all servers

```
# clpcl -t -a
```

Stop server0 : Command succeeded.

Stop server1 : Command succeeded.

When all the servers are stopped, the display after running the command should look similar to above. Stop server_name : Execution result.

When the stopping process fails, the display may be different from the example above depending on the process.

Wait for the stopping of all servers of the EXPRESSCLUSTER service.

Error Messages

Message	Cause/Solution
Log in as administrator.	Log in as a user with Administrator privileges.
Invalid configuration file. Create valid cluster configuration data by using the Builder.	Create valid cluster configuration data using the Builder.
Invalid option.	Specify a valid option
Performed stop processing to the stopped cluster service.	The stopping process has been executed to the stopped EXPRESSCLUSTER service.
Performed startup processing to the active cluster service.	The startup process has been executed to the activated EXPRESSCLUSTER service.
Command timeout.	The command timed out.
Failed to return the server. Check the status of failed server.	Failed to return the server. Check the status of the failed server.
Could not connect to the server. Check if the cluster service is active.	Check if the EXPRESSCLUSTER service is activated.
Failed to obtain the list of nodes. Specify a valid server name in the cluster.	Specify the valid name of a server in the cluster.
Failed to obtain the service name.	Failed to obtain the service name.
Failed to operate the service.	Failed to operate the service.
Resumed the cluster service that is not suspended.	Resumed the EXPRESSCLUSTER service that is not suspended.
invalid server status.	Check if the EXPRESSCLUSTER service is activated.
Server is busy. Check if this command is already run.	This command may be run already. Check it.

Message	Cause/Solution
Server is not active. Check if the cluster service is active.	Check if the EXPRESSCLUSTER service is activated.
There is one or more servers of which cluster service is active. If you want to perform resume, check if there is any server whose cluster service is active in the cluster.	When you execute the command to resume, check if there is no server in the cluster on which the EXPRESSCLUSTER service is activated.
All servers must be activated. When suspending the server, the cluster service need to be active on all servers in the cluster.	When you execute the command to suspend, the EXPRESSCLUSTER service must be activated in all servers in the cluster.
Resume the server because there is one or more suspended servers in the cluster.	Execute the command to resume because some server(s) in the cluster is suspended.
Invalid server name. Specify a valid server name in the cluster.	Specify the valid name of a server in the cluster.
Connection was lost. Check if there is a server where the cluster service is stopped in the cluster.	Check if there is any server on which the EXPRESSCLUSTER service has stopped in the cluster.
invalid parameter.	The value specified as a command parameter may be invalid.
Internal communication timeout has occurred in the cluster server. If it occurs frequently, set the longer timeout.	A timeout occurred in the EXPRESSCLUSTER internal communication. If time-out keeps occurring, set the internal communication time-out longer.
Processing failed on some servers. Check the status of failed servers.	If stopping process is executed to all servers, there is one or more servers on which the stopping process has failed. Check the status of the server(s) on which the stopping process has failed.
Internal error. Check if memory or OS resources are sufficient.	Check if the memory or OS resource is sufficient.

Shutting down a specified server (clpdown command)

clpdown: the `clpdown` command shuts down a specified server.

Command line

```
clpdown [-r] [-h hostname]
```

Description	This command stops the EXPRESSCLUSTER service and shuts down a server.	
Option	None	Shuts down a server.
	<code>-r</code>	Reboots the server.
	<code>-h</code> <i>host_name</i>	Makes a processing request to the server specified in <i>host_name</i> . Makes a processing request to the server on which this command runs (local server) if the <code>-h</code> option is omitted.
Return Value	0	Success
	Other than 0	Failure
Remarks	This command returns control when the group stop processing is completed.	
Notes	<p>Run this command as a user with Administrator privileges.</p> <p>This command cannot be executed while a group is being started or stopped.</p> <p>For the name of a server for the <code>-h</code> option, specify the name of a server in the cluster.</p>	
Example of a command entry	<p>Example 1: Stopping and shutting down the EXPRESSCLUSTER service in the local server</p> <pre># clpdown</pre> <p>Example 2: Shutting down and rebooting server1 from server0</p> <pre># clpdown -r -h server1</pre>	
Error Message	See “Operating the cluster (clpcl command)” on page 345.	

Shutting down the entire cluster (clpstdn command)

clpstdn: the `clpstdn` command shuts down the entire cluster

Command line

```
clpstdn [-r] [-h hostname]
```

Description	This command stops the EXPRESSCLUSTER service in the entire cluster and shuts down all servers.	
Option	None	Executes cluster shutdown.
	-r	Executes cluster shutdown reboot.
	-h <i>host_name</i>	Makes a processing request to the server specified in <i>host_name</i> . Makes a processing request to the server on which this command runs (local server) if the -h option is omitted.

Return Value	0	Success
	Other than 0	Failure

Remarks	This command returns control when the group stop processing is completed.
Notes	<p>Run this command as a user with Administrator privileges.</p> <p>This command cannot be executed while a group is being started or stopped.</p> <p>For the name of a server for the -h option, specify the name of a server in the cluster.</p> <p>A server that cannot be accessed from the server that runs the command (for example, a server with all LAN heartbeat resources are off-line.) will not shut down.</p>
Example of a command entry	<p>Example 1: Shutting down the cluster</p> <pre># clpstdn</pre> <p>Example 2: Performing the cluster shutdown reboot</p> <pre># clpstdn -r</pre>
Error Message	See "Operating the cluster (clpcl command)" on page 345.

Operating groups (clpgrp command)

clpgrp: the `clpgrp` command operates groups

Command line

```
clpgrp -s [grpname] [-h hostname] [-f] [--apito time-out]
clpgrp -t [grpname] [-h hostname] [-f] [--apito time-out]
clpgrp -m [grpname] [-h hostname] [-a hostname] [--apito time-out]
clpgrp -l [grpname] [-h hostname] [-a hostname] [--apito time-out]
clpgrp -n <grpname>
```

Description	This command starts, deactivates or moves groups. This command also migrates groups.	
Option	-s [grpname]	Starts groups. When you specify the name of a group, only the specified group starts up. If no group name is specified, all groups start up.
	-t [grpname]	Stops groups. When you specify the name of a group, only the specified group stops. If no group name is specified, all groups stop.
	-m [grpname]	Moves groups. When you specify the name of a group, only the specified group is moved. If no group name is specified, all the groups are moved.
	-l [grpname]	Migrates the specified group. The group type must be "virtualmachine". If no group name is specified, all the active migration groups on the server are migrated.
	-h hostname	Makes a processing request to the server specified in <i>hostname</i> . Makes a processing request to the server on which this command runs (local server) if the <code>-h</code> option is omitted.
	-a hostname	Defines the server which is specified by <i>hostname</i> as a destination to which a group will be moved. When the <code>-a</code> option is omitted, the group will be moved according to the failover policy
	-f	If you use this option with the <code>-s</code> option against a group activated on a remote server, it will forcefully be started on the server that requested the process. If this command is used with the <code>-t</code> option, the group will be stopped forcefully.
	-f <grpname>	Displays the name of the server on which the group has been started.
	--apito time-out	Specify the time in seconds to wait for groups to be started, stopped, moved, or migrated (internal communication timeout). A value between 1 to 9999 can be specified. When the <code>--apito</code> option is not specified, the command waits according to the value set for the internal communication timeout in the cluster

property.

Return Value	0	Success
	Other than 0	Failure

Notes Run this command as a user with Administrator privileges.
 The EXPRESSCLUSTER service must be activated on the server that runs this command
 Specify a server in the cluster when you specify the name of server name for the `-h` and `-a` options.

If the group is moved by using the `[-m]` option, it is determined to be normal at the time of performing the group start process on the destination server. Please be aware that even if this command is executed successfully, the activation of the resource may fail on the server to which the group is moved. In order to check whether or not the group has started by using the return value, execute the following:

```
# clpgrp -s [group_name] [-h hostname] -f.
```

When “Normal” is configured for the failover exclusion attribute of a group and you want to move the group with the `-m` option, explicitly specify a server to which the group is moved by using the `-a` option.

Moving a group will fail when “Normal” groups in all servers to which the group can be moved are activated if you omit the `-a` option.

Example of Execution

The following is an example of status transition when operating the groups.

Example: The cluster has two servers and two groups.

Failover policy of group

```
groupA server1 -> server2
groupB server2 -> server1
```

1. Both groups are stopped.

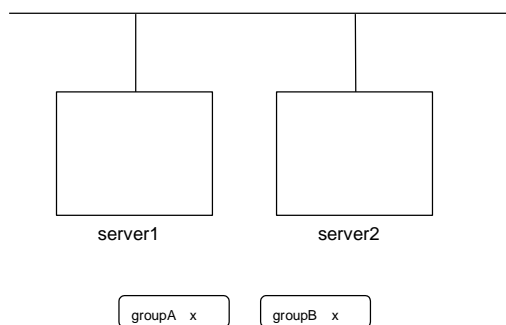

2. Run the following command on server1.

```
# clpgrp -s groupA
```

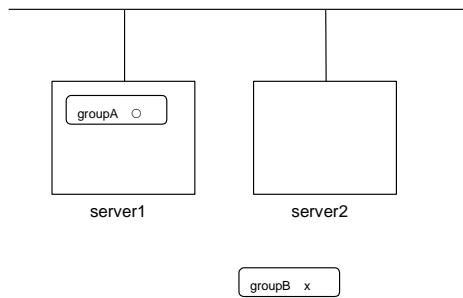

GroupA starts in server1.

3. Run the following command in server2.

```
# clpgrp -s
```

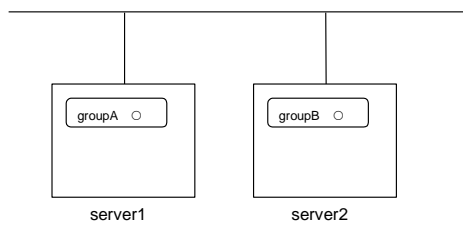

All groups that are currently stopped but can be started start in server2.

4. Run the following command in server1

```
# clpgrp -m groupA
```

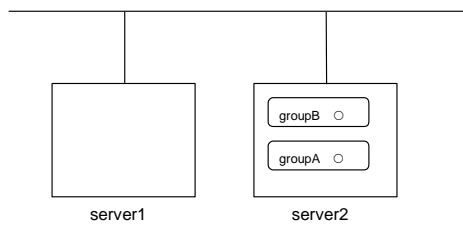

GroupA moves to server2.

5. Run the following command in server1

```
# clpgrp -t groupA -h server2
```

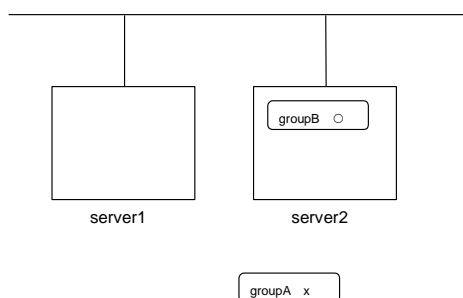

GroupA stops.

6. Run the following command in server1.

```
# clpgrp -t
```

Command Succeeded.

When the command is executed, there is no group running on server1. So, “Command Succeeded.” appears.

7. Add `-f` to the command you have run in Step 6 and execute it on server1.

```
# clpgrp -t -f
```

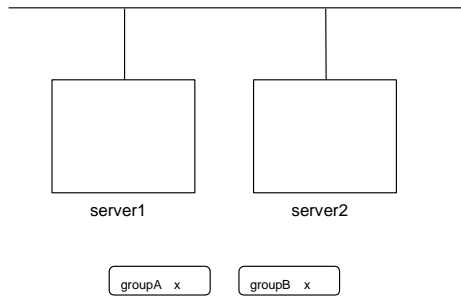

Groups which were started in server2 can be forcefully deactivated from server1.

Error message

Message	Cause/Solution
Log in as administrator.	Log in as a user with Administrator privileges.
Invalid configuration data. Create valid cluster configuration data by using the Builder.	Create valid cluster configuration data using the Builder
Invalid option.	Specify a valid option
Could not connect to the server. Check if the cluster service is active.	Check if the EXPRESSCLUSTER service is operating.
Invalid server status. Check if the cluster service is active.	Check if the EXPRESSCLUSTER service is operating.
Server is not active. Check if the cluster service is active.	Check if the EXPRESSCLUSTER service is operating.
Invalid server name. Specify a valid server name in the cluster.	Specify the valid server name in the cluster.
Connection was lost. Check if there is a server where the cluster service is stopped in the cluster.	Check if there is any server on which the EXPRESSCLUSTER service has stopped in the cluster.
Invalid parameter.	The value specified as a command parameter may be invalid.
Internal communication timeout has occurred in the cluster server. If it occurs frequently, set a longer timeout.	A time-out occurred in the EXPRESSCLUSTER internal communication. If time-out keeps occurring, set the internal communication time-out longer.
Invalid server. Specify a server that can run and stop the group, or a server that can be a target when you move the group.	Server that starts and stops the group or to which the group is moved is invalid. Specify a valid server.
Could not start the group. Try it again after the other server is started, or after the Wait Synchronization time is timed out.	Start up the group after waiting for the remote server to start up, or after waiting for the timeout of the start-up wait time.
No operable group exists in the server.	Check if there is any group that is operable in the server which requested

Message	Cause/Solution
	the process.
The group has already been started on the local server.	Check the status of the group by using the WebManager or the clpstat command.
The group has already been started on the other server. To start/stop the group on the local server, use -f option.	Check the status of the group by using the WebManager or the clpstat command. If you want to start up or stop a group which was started in a remote server from the local server, move the group or run the command with the -f option.
The group has already been stopped.	Check the status of the group by using the WebManager or the clpstat command.
Failed to start one or more resources. Check the status of group.	Check the status of group by using the WebManager or the clpstat command.
Failed to stop one or more resources. Check the status of group.	Check the status of group by using the WebManager or the clpstat command.
The group is busy. Try again later.	The group is now being started or stopped. Wait for a while and try again.
An error occurred on one or more groups. Check the status of group.	Check the status of the group by using the WebManager or the clpstat command.
Invalid group name. Specify a valid group name in the cluster.	Specify the valid name of a group in the cluster.
Server is isolated.	The server has been suspended. The server is rebooted after it went down.
Some invalid status. Check the status of cluster.	The status is invalid. Check the status of the cluster.
Log in as administrator.	Check if the memory or OS resource is sufficient.
Failed to migrate the group.	If the -l option is used, check whether the type of the specified group is "virtualmachine".
The specified group cannot be migrated.	Check the status of the group.
The specified group is not vm group.	Check if the type of the group is set to the virtual machine.
Migration resource does not exist.	Check if the virtual machine resource exists in the group.
Migration resource is not online.	Check if the virtual machine resource has already started.
Server is not in a condition to start group. Critical monitor error is detected.	Check the status of each server.
There is no appropriate destination for the group. Critical monitor error is detected.	Check the status of each server.

Collecting logs (clplogcc command)

clplogcc: the `clplogcc` command collects logs.

Command line

```
clplogcc [ [-n targetnode1 -n targetnode2 .....] ]
          [-t collect_type] [-o path] [--local] [--evt event_type ...]
```

Description	This command collects information including logs and the OS information by accessing the data transfer server.	
Option	None	Collects logs in the cluster.
	-t <i>collect_type</i>	Specifies a log collection pattern. When this option is omitted, a log collection pattern will be type1. Information on log collection types is provided in the next section.
	-o <i>path</i>	Specifies the output destination of collector files. When this option is skipped, logs are output under tmp of the installation path.
	-n <i>targetnode</i>	Specifies the name of a server that collects logs. With this specification, logs of the specified server, rather than of the entire cluster, will be collected.
	--local	Collects logs on the local server without going through the data transfer server. The -n option cannot be specified at the same time.
	--evt <i>event_type</i>	Specifies the type of the event log to be collected. When this option is skipped, application logs, system logs and security logs will be collected. This option is enabled only when [--local] option is specified.
		For details, see "Specifying a event log type to collect (--evt option)".
Return Value	0	Success
	Other than 0	Failure
Remarks	Since log files are compressed by cab, decompress them using an appropriate application.	
Notes	Run this command as a user with Administrator privileges.	
	For the name of server for the -n option, specify the name of server that allows name resolution. If name resolution is not possible, specify the interconnect or public LAN address.	
	When you run this command, access the servers in the cluster in the order below, and use one of the paths that allowed successful access.	
	1. via the IP address on the interconnect LAN	
	2. via the IP address on the public LAN	
	3. via the IP address whose name was resolved by the server name in the	

cluster configuration data

Example of command execution

Example 1: Collecting logs from all servers in the cluster

```
# clplogcc
Please wait, now collecting..
```

```
server  status      result
-----
server0  Completion  Normal
server1  Completion  Normal
```

The execution results of the server that collected logs are displayed.

Server name Progress Result

Execution Result

For this command, the following processes are displayed.

Steps in Process	Meaning
Preparing	Initializing
Connecting	Connecting to the server
Compressing	Compressing log files
Transmitting	Sending log files
Disconnecting	Disconnecting from the server
Completion	Finished collecting logs

The following results (server status) are displayed:

Result (server status)	Meaning
Normal	Completed successfully
Canceled	Canceled by the user
Invalid Parameters	Parameters are invalid
Compression Error	There was an error while compressing files
Timeout	Time-out occurred.
Busy	The server is busy.
No Free Space	No free space on the disk.
File I/O Error	There was a file I/O error.
Unknown Error	Failure caused by other errors

Error Message

Message	Cause/Solution
Log in as administrator.	Log in as a user with Administrator privileges.
Invalid option.	Specify a valid option.
Collect type must be specified 'type1' or 'type2' or 'type3'. Incorrect collection type is specified.	Invalid collection type is specified.
Specifiable number of servers are the max number of servers that can constitute a cluster.	The number of servers you can specify is within the maximum number of servers for cluster configuration.
Failed to obtain properties.	Failed to obtain the properties.
Failed to obtain the list of nodes. Specify a valid server name in the cluster.	Specify the valid name of a server in the cluster.
Invalid server name. Specify a valid server name in the cluster.	Specify the invalid server name in the cluster.
Failed to collect log.	Failed to collect logs.
Server is busy. Check if this command is already run.	This command may be run already. Check it.
Internal error. Check if memory or OS resources are sufficient.	Check if the memory or OS resource is sufficient.

Collecting logs by specifying a type (-t option)

To collect only the specified types of logs, run the `clplogcc` command with the `-t` option.

Specify a type from 1 through 4 for the log collection.

	type1	type2	type3	type4
(1) Default collection information	y	y	y	n
(2) event log	y	y	y	y
(3) Dr.Watson Log	y	y	y	y
(4) user dump	y	y	n	n
(5) Diagnostics Report	y	y	n	n
(6) Registry	y	y	y	n
(7) Script	y	y	y	n
(8) ESM/PRO/AC and ESM/PRO/UPSC Logs	y	y	y	n
(9) HA Logs	n	y	n	n

(y=yes, n=no)

Run this command from the command line as follows.

Example: When collecting logs using type2

```
# clplogcc -t type2
```

When no option is specified, a log type will be type 1.

- ◆ Information to be collected by default
 - Logs of each module in the EXPRESSCLUSTER Server
 - Attribute information on each module (dir) in the EXPRESSCLUSTER Server
 - In bin
 - In cloud
 - In alert/bin, webmgr/bin
 - In %SystemRoot%\system32\drivers
 - EXPRESSCLUSTER version information
 - OS information
 - update log
 - CPU license and node license
 - Configuration file
 - Policy file
 - Cloud environment configuration directory
 - Shared memory dump
 - Local node status of ExpressCluster (`clpstat --local` execution results)
 - Host name and domain name information (`hostname` execution result)
 - Network information (`netstat` execution result)
 - IP routing table information (`route print` execution results)
 - Memory usage status (`mem` execution result (only for the IA32 version))
 - Process existing status (`tasklist` execution result)
 - `ipconfig` (`ipconfig` execution result)
 - Windows firewall settings (`netsh` execution result)
 - SNP (Scalable Networking Pack) setting (`netsh` execution result)
 - Task scheduler settings (`schtasks` execution result)
- ◆ event log
 - application log (AppEvent.Evt, Application.evtx, Application.txt)

- system log (SysEvent.Evt, System.evt, System.txt)
- security log (SecEvent.Evt, Security.evt, Security.txt)
- ◆ Dr. Watson Log/Windows error report
 - drwtsn32.log (for Windows Server 2003)
 - ***.wer (for Windows Server 2008 or later)
- ◆ User dump
 - user.dmp (for Windows Server 2003)
 - ***.hdmp (for Windows Server 2008)
 - ***.mdmp (for Windows Server 2008)
 - ***.dmp (for Windows Server 2012)
- ◆ Diagnostics Report
 - the result of running msinfo32.exe
- ◆ Registry
 - Registry information of the EXPRESSCLUSTER Server
 - HKLM\SOFTWARE\NEC\EXPRESSCLUSTER\Alert
 - HKLM\SOFTWARE\NEC\EXPRESSCLUSTER\MirrorList
 - HKLM\SOFTWARE\NEC\EXPRESSCLUSTER\RC
 - HKLM\SOFTWARE\NEC\EXPRESSCLUSTER\VCOM
 - registry information of diskflt
 - Registry information of OS
 - HKLM\SYSTEM\CurrentControlSet\Services\Disk
 - HKLM\SYSTEM\CurrentControlSet\Control\Session Manager\DOS Devices
 - HKLM\SYSTEM\MountedDevices
 - HKLM\SYSTEM\CurrentControlSet\Enum\SCSI
 - HKLM\SYSTEM\CurrentControlSet\Enum\STORAGE
 - HKLM\SYSTEM\CurrentControlSet\Services\symc8xx
 - HKLM\SYSTEM\CurrentControlSet\Control\FileSystem
- ◆ Script

Start/stop script for a group that was created with the Builder.

If you specify a user-defined script, it is not included in the log collection information. It must be collected separately.
- ◆ ESM/AC and ESM/UPSC logs

Files collected by running the acupslog.exe command.
- ◆ HA logs
 - System resource information
 - JVM monitor log
 - System monitor log

Output paths of log files (-o option)

- ◆ Log file is named and be saved as “*server_name-log.cab*”
- ◆ Since log files are compressed by cab, decompress them by using an appropriate application.

If not specifying -o option

Logs are output in tmp of installation path.

When the -o option is specified:

If you run the command as follows, logs are located in the specified `c:\tmp` directory.

```
# clplogcc -o C:\tmp
```

Specifying log collector server (-n option)

By using the `-n` option, you can collect logs only from the specified server.

Example: Collecting logs from Server1 and Server3 in the cluster.

```
# clplogcc -n Server1 -n Server3
```

- ◆ Specify a server in the same cluster.
- ◆ The number of servers you can specify is within the maximum number of servers in the cluster configuration.

Specifying a event log type to collect (--evt option)

You can specify the type of the event log included in the information obtained at the log collection.

Specify one or more text strings that represent event log types as shown in the following table after `[-evt]` option.

Event log type	Character string to specify
Application log	app
System log	sys
Security log	sec

Example) Collecting the system log and the security log

```
# clplogcc --local --evt sys sec
```

- ◆ This option is enabled only when the `[-local]` option is specified.

Collecting information when a failure occurs

When the following failure occurs, the information for analyzing the failure is collected.

- ◆ When the cluster service that forms the cluster fails due to termination by an internal status error.
- ◆ When a group resource activation error or deactivation error occurs.
- ◆ When monitoring error occurs in a monitor resource.

Information to be collected is as follows:

- ◆ Information created by running a command
 - Host name and domain name information (hostname execution result)
 - Network information (netstat execution result)
 - Memory usage status (mem execution result (only for the IA32 version))
 - Process existing status (tasklist execution result)
 - ipconfig (ipconfig execution result)

These are collected by default in the log collection. You do not need to collect them separately.

Creating a cluster and backing up configuration data (clpcfctrl command)

Creating a cluster (clpcfctrl --push)

clpcfctrl --push: the `clpcfctrl --push` command delivers cluster configuration data to servers.

Command line

```
clpcfctrl --push [-w] [-x <path>] [-c <hostname>|<IP>] [-h
<hostname>|<IP>]
[-p <portnumber>] [--force]
```

Description	This command delivers the configuration data created by the Builder to servers.	
Option	<code>--push</code>	Specify this option when delivering the data. You cannot omit this option.
	<code>-x</code>	Specify this option to deliver the configuration data that is in the specified directory.
	<code>-w</code>	Displays that the graphic character code of the cluster configuration data file to be delivered is SJIS. In general, it is not necessary to specify this option You cannot specify <code>-l</code> and <code>-w</code> together. Specify either <code>-l</code> or <code>-w</code> .
	<code>-c</code>	Specifies a server to access for acquiring a list of servers. Specify a host name or IP address.
	<code>-h</code>	Specifies a server to which configuration data is delivered. Specify host name or IP address. If this option is omitted, configuration data is delivered to all servers.
	<code>-p</code>	Specifies a port number of data transfer port. When this option is omitted, the default value will be used. In general, it is not necessary to specify this option.
	<code>--force</code>	Even if there is a server that has not started, the configuration data is delivered forcefully.
	<code>--nocheck</code>	The configuration data is delivered without the checking operation that is required when applying a settings change to the cluster. To apply the delivered configuration data to the cluster, therefore, execute the required operation manually.

Return Value	0	Success
	Other than 0	Failure

Notes Run this command as a user with Administrative authority.

When you run this command, access the servers in the order below, and use one of the paths that allowed successful access.

1. via the IP address on the interconnect LAN
2. via the IP address on the public LAN
3. via the IP address whose name was resolved by the server name in the cluster configuration data

When delivering the cluster configuration data, the current cluster configuration data and the configuration data to be delivered are compared.

If there is any change in the configuration data, the following message output. Follow the instructions of the message to complete the delivery.

Message	Solution
Please stop the EXPRESSCLUSTER.	Stop the server.
Please suspend the EXPRESSCLUSTER	Suspend the server.
Please stop the following groups.	Stop the group of which setting has been changed.
Reboot of a cluster is necessary to reflect setting.	Shut down and reboot the cluster to apply the change of settings.
To apply the changes you made, restart the EXPRESSCLUSTER Web Alert service.	Restart the Web Alert service to apply the change of settings.
To apply the changes you made, restart the EXPRESSCLUSTER Manager service.	Restart the EXPRESSCLUSTER Manager service to apply the change of settings.
Start of a cluster is necessary to reflect setting.	This is the message displayed at the initial cluster configuration. Start the cluster.

The `--nocheck` option is used only for special purposes including a maintenance procedure. Do not use the `--nocheck` option for normal operations.

Example of command execution

Example 1: Generating a cluster from the floppy disk with the data saved by the Builder on Windows

```
# clpcfctrl --push -x C:\tmp\config
file delivery to server 10.0.0.11 success.
file delivery to server 10.0.0.12 success.
Command succeeded.(code:0)
```

Example 2: Delivering configuration data that was saved on the file system using the Builder on Windows

```
# clpcfctrl --push -x C:\tmp\config -h 10.0.0.11
Command succeeded.(code:0)
```

Error Message

Message	Cause/Solution
Command succeeded.	The command ran successfully.
Log in as administrator.	Log in as a user with Administrator privileges.
This command is already run.	This command has already been run.
invalid option.	This option is invalid. Check the option.
Invalid mode. Check if -push or -pull option is specified.	Check if --push is specified.
The target directory does not exist.	The specified directory is not found. Check if the specified directory is valid.
Invalid host name. Server specified by -h option is not included in the configuration	The server specified with -h is not included in configuration data. Check if the specified server name or IP address is correct.
Invalid type of file.	Check that the character code used for the configuration data is correct.
Failed to initialize the xml library. Check if memory or OS resources are sufficient.	Check if the memory or OS resources are sufficient.
Failed to load the configuration file. Check if memory or OS resources are sufficient.	
Failed to change the configuration file. Check if memory or OS resources are sufficient.	
Failed to load the all.pol file. Reinstall the RPM cluster.	Reinstall the EXPRESSCLUSTER Server.
Failed to load the cfctrl.pol file. Reinstall the RPM cluster.	Reinstall the EXPRESSCLUSTER Server.
Failed to get the install path. Reinstall the RPM cluster.	Reinstall the EXPRESSCLUSTER Server.
Failed to get the list of group.	Failed to acquire the list of group.
Failed to get the list of resource.	Failed to acquire the list of resource.
Failed to initialize the trncl library. Check if memory or OS resources	Check if the memory or OS resources are sufficient.

Message	Cause/Solution
are sufficient.	
Failed to connect to trnsv. Check if the other server is active.	Accessing the server has failed. Check if the other server has been started up.
Failed to get the list of node. Check if the server specified by -c is a member of the cluster.	Check if the server specified by -c is a cluster member.
File delivery failed. Failed to deliver the configuration data. Check if the other server is active and run the command again.	Delivering configuration data has failed. Check if other server(s) has been started. Run the command again after the server has started up.
Multi file delivery failed. Failed to deliver the configuration data. Check if the other server is active and run the command again.	Delivering configuration data has failed. Check if other server(s) has been started. Run the command again after the server has started up.
Failed to deliver the configuration data. Check if the other server is active and run the command again.	Delivering configuration data has failed. Check if other server(s) has been started. Run the command again after the server has started up.
Failed to upload the configuration file. Check if the other server is active and run the command again.	Delivering configuration data has failed. Check if other server(s) has been started
Failed to get the collect size.	Getting the size of the collector file has failed. Check if other server(s) has been started.
Failed to collect the file.	Collecting of the file has failed. Check if other server(s) has been started.
Canceled to deliver the configuration file since it failed to connect to one or more server. If you want to deliver the configuration file to servers that can be connected, run the command again with "-force" option.	Canceled the delivery of the configuration data. There are some servers that failed to connect. If you want to deliver the configuration data only to the server that can be connected, run the command again by using the <code>--force</code> option.
The directory "work" is not found. Reinstall the RPM.	Reinstall the EXPRESSCLUSTER Server.
Failed to make a working directory.	Check if the memory or OS resources are sufficient.
The directory does not exist.	
This is not a directory.	
The source file does not exist.	
The source file is a directory.	
The source directory does not exist.	
The source file is not a directory.	
Failed to change the character code set (EUC to SJIS).	
Failed to change the character code set (SJIS to EUC).	

Message	Cause/Solution
Failed to allocate memory.	Check if the memory or OS resources are sufficient.
Failed to change the directory.	
Failed to make a directory.	
Failed to remove the directory.	
Failed to remove the file.	
Failed to open the file.	
Failed to read the file.	
Failed to copy the file.	
Failed to create the mutex.	
Internal error. Check if memory or OS resources are sufficient.	
Failed to check server property. Check if the server name or ip addresses are correct by builder.	Check if the server name and the IP address of the configuration information are correctly set.
Please stop the following resources.	Stop the resource of which the configuration has been changed.
Failed to get server status.	Failed to acquire the server status. Check that the server is operating normally.
target does not exist.	The specified directory does not exist. Check that the directory is specified correctly.
connect to server succeeded.	Connected to the server successfully.
connect to server failed.	Failed to connect to the server. Check that the server has started.
connect to server failed. (please retry later)	Failed to connect to the server. Check that the server has started. Wait a short while and then retry.
clp.conf delivered.	Configuration data has already been delivered.
To apply the changes you made, reboot the cluster.	To apply the changes you made, restart the cluster.
To apply the changes you made, start the cluster service.	To apply the changes you made, start the cluster.
Failed to deliver the configuration file. Check if the other server is active and run the command again.	Delivering configuration data has failed. Check if other server(s) has been started. Run the command again after the server has started up.

Backing up the cluster configuration data

clpcfctrl --pull: the `clpcfctrl --pull` command backs up cluster configuration data.

Command line

```
clpcfctrl --pull [-w] [-x <path>] [-h <hostname>|<IP>]
               [-p <portnumber>]
```

Description	This command backs up cluster configuration data to be used for the Builder.	
Option	<code>--pull</code>	Specify this option when performing backup. You cannot omit this option.
	<code>-x</code>	Specify this option when backing up configuration data in the specified directory.
	<code>-w</code>	Save the configuration data with graphic character code, SJIS.
	<code>-h</code>	Specifies the source server for backup. Specify a host name or IP address. When this option is omitted, the configuration data on the server running the command is used.
	<code>-p</code>	Specifies a port number of data transfer port. When this option is omitted, the default value is used. In general, it is not necessary to specify this option.
Return Value	0	Success
	Other than 0	Failure
Notes	Run this command as a user with Administrator privileges. When you run this command, access the servers in the cluster in the order below, and use one of the paths that allowed successful access. <ol style="list-style-type: none"> 1. via the IP address on the interconnect LAN 2. via the IP address on the public LAN 3. via the IP address whose name was resolved by the server name in the cluster configuration data 	

Example of command execution

Example 1: Backing up configuration data into the specified directory

```
# clpcfctrl --pull -x C:/tmp/config
Command succeeded. (code:0)
```

Example 2: Backing up configuration data of the specified server into the specified directory

```
# clpcfctrl --pull -x C:/tmp/config -h 10.0.0.11
Command succeeded. (code:0)
```

Error Message

Message	Cause/Solution
Log in as administrator.	Log on as a user with Administrator privileges.
This command is already run.	This command has already been run.
invalid option.	The option is invalid. Check the option.
Invalid mode. Check if -push or -pull option is specified.	Check if --pull is specified.
Failed to initialize the xml library. Check if memory or OS resources are sufficient.	Check if the memory or OS resources are sufficient.
Failed to load the configuration file. Check if memory or OS resources are sufficient.	
Failed to change the configuration file. Check if memory or OS resources are sufficient.	
Failed to load the all.pol file. Reinstall the cluster.	Reinstall the EXPRESSCLUSTER Server.
Failed to load the cctrl.pol file. Reinstall the cluster.	Reinstall the EXPRESSCLUSTER Server.
Failed to get the install path. Reinstall the cluster.	Reinstall the EXPRESSCLUSTER Server.
Failed to initialize the trncl library. Check if memory or OS resources are sufficient	Check if the memory or OS resources are sufficient.
Failed to connect to trnsv. Check if the other server is active.	Accessing the server has failed. Check if other server(s) has been started.
The directory "work" is not found. Reinstall the cluster.	Reinstall the EXPRESSCLUSTER Server.
Failed to make a working directory.	Check if the memory or OS resources are sufficient.
The directory does not exist.	
This is not a directory.	
The source file does not exist.	
The source file is a directory.	
The source directory does not exist.	
The source file is not a directory.	

Message	Cause/Solution
Failed to change the character code set (EUC to SJIS).	
Failed to change the character code set (SJIS to EUC).	
Failed to allocate memory.	Check if the memory or OS resources are sufficient.
Failed to change the directory.	
Failed to make a directory.	
Failed to remove the directory.	
Failed to remove the file.	
Failed to open the file.	
Failed to read the file.	
Failed to write the file.	
Failed to copy the file.	
Failed to create the mutex.	
Internal error. Check if memory or OS resources are sufficient.	

Adjusting time-out temporarily (clptoratio command)

clptoratio: the `clptoratio` command extends or displays the current time-out ratio.

Command line

```
clptoratio -r <ratio> -t <time>
clptoratio -i
clptoratio -s
```

Description This command displays the current time-out ratio or temporarily extends the various time-out values of the following on all servers in the cluster.

- + Monitor resource
- + Heartbeat resource
- + Disk Agent
- + Alert synchronous service
- + WebManager service

Note that the following value is not supported.

- + Kernel mode LAN heartbeat resources

Option	-r	Specifies the time-out ratio.
	<i>ratio</i>	Use 1 or larger integer. The maxim time-out ratio is 10,000. If you specify "1," you can return the modified time-out ratio to the original as you can do so when you are using the -i option.
	-t	Specifies the extension period.
	<i>time</i>	You can specify minutes for m, hours for h, and days for d. The maximum period of time is 30 days. Example: 2m, 3h, 4d
	-i	Sets back the modified time-out ratio.
	-s	Refers to the current time-out ratio.

Return Value	0	Success
	Other than 0	Failure

Remarks When the cluster is shutdown, the time-out ratio you have set will become ineffective. However, if any server in the cluster is not shut down, the time-out ratio and the extension period that you have set will be maintained.

With the -s option, you can only refer to the current time-out ratio. You cannot see other information such as remaining time of extended period.

You can see the original time-out value by using the status display command.

```
Heartbeat time-out # clpstat -cl -detail
```

```
Monitor resource time-out # clpstat -mon
monitor_resource_name -detail
```

Notes

Run this command as a user with Administrator privileges.

Make sure that the EXPRESSCLUSTER service is activated in all servers in the cluster.

When you set the time-out ratio, make sure to specify the extension period. However, if you set “1” for the time-out ratio, you cannot specify the extension period.

You cannot specify a combination such as “2m3h,” for the extension period.

Example of a command entry

Example 1: Doubling the time-out ratio for three days

```
# clptoratio -r 2 -t 3d
```

Example 2: Setting back the time-out ratio to original

```
# clptoratio -i
```

Example 3: Referring to the current time-out ratio

```
# clptoratio -s
```

```
present toratio : 2
```

The current time-out ratio is set to 2.

Error Message

Message	Cause/Solution
Log in as administrator.	Log on as a user with Administrator privileges.
Invalid configuration file. Create valid cluster configuration data by using the Builder.	Create valid cluster configuration data by using the Builder.
invalid option.	Specify a valid option.
Specify a number in a valid range.	Specify a number within a valid range.
Specify a correct number.	Specify a valid number.
Scale factor must be specified by integer value of 1 or more.	Specify 1 or larger integer for ratio.
Specify scale factor in a range less than the maximum scale factor.	Specify a ratio that is not larger than the maximum ratio.
Set the correct extension period. ex) 2m, 3h, 4d	Set a valid extension period.
Set the extension period in a range less than the maximum extension period.	Set the extension period which does not exceed the maximum extension period.
Could not connect to the server. Check if the cluster service is active.	Check that the EXPRESSCLUSTER service is operating.
Server is not active. Check if the cluster service is active.	Check that the EXPRESSCLUSTER service is operating.
Connection was lost. Check if there is a server where the cluster service is stopped in the cluster.	Check if there is any server in the cluster that the EXPRESSCLUSTER service stopped.
Invalid parameter.	The value specified as the command parameter may be invalid.

Message	Cause/Solution
Internal communication timeout has occurred in the cluster server. If it occurs frequently, set a longer timeout.	A time-out occurred in the EXPRESSCLUSTER internal communication. If time-out keeps occurring, set the internal communication time-out longer.
Processing failed on some servers. Check the status of failed servers.	There is a server in which the processing has failed. Check the statuses of servers in the cluster. Run the command with all servers in the cluster activated.
Internal error. Check if memory or OS resources are sufficient.	Check if the memory or OS resources are sufficient.

Modifying the log level and size (clplogcf command)

clplogcf: the `clplogcf` command modifies and displays log level and log output file size.

Command line

```
clplogcf -t <type> -l <level> -s <size>
```

Description	This command modifies the log level and log output file size, or displays the values currently configured.	
Option	-t	<p>Specifies a module type whose settings will be changed.</p> <p>If both <code>-l</code> and <code>-s</code> are omitted, the information set to the specified module will be displayed. See the list of “Types that can be specified to the <code>-t</code> option” for types which can be specified.</p>
	-l	<p>Specifies a log level.</p> <p>You can specify one of the following for a log level.</p> <p style="padding-left: 40px;">1, 2, 4, 8, 16, 32</p> <p>You can see more detailed information as the log level increases.</p> <p>See the list of “Default log levels and log file sizes” for default values of each module type.</p>
	-s	<p>Specifies the size of a file for log output.</p> <p>The unit is byte.</p>
	None	<p>Displays the entire configuration information currently set.</p>
Return Value	0	Success
	Other than 0	Failure
Remarks	<p>Each type of output logs from EXPRESSCLUSTER uses two log files. Therefore, it is necessary to have the disk space that is twice larger than what is specified by <code>-s</code>.</p>	
Notes	<p>Run this command as a user with Administrator privileges.</p> <p>To run this command, the EXPRESSCLUSTER Event service must be started.</p> <p>Configuration change is effective only to servers on which this command was run. Rebooting the server restores the settings to their pre-change values.</p>	

Example of command execution

Example 1: Modifying the pm log level

```
# clplogcf -t pm -l 8
```

Example 2: Seeing the pm log level and log file size

```
# clplogcf -t pm
TYPE, LEVEL, SIZE
pm, 8, 1000000
```

Example 3: Displaying the values currently configured

```
# clplogcf
TYPE, LEVEL, SIZE
trnsv, 4, 1000000
xml, 4, 1000000
logcf, 4, 1000000
```

Error Message

Message	Cause/Solution
Log in as administrator.	Log on as a user with Administrator privileges.
invalid option.	The option is invalid. Check the option.
Failed to change configuration. Check if the event service is running.	clpevent may not have been started.
invalid level	The specified level is invalid.
invalid size	The specified size is invalid.
Failed to initialize the xml library. Check if memory or OS resources are sufficient.	Check if the memory or OS resources are sufficient.
Failed to print current configuration. Check if the event service is running.	clpevent may not be started yet.

Types that can be specified for the -t option (y=yes, n=no)

Type	Module	Description
alert	clpaltinsert.exe	Alert
apicl	clpapicl.dll	API client library
apicl_rc	clpapicl.dll	API client library
apisv	clpapisv.dll	API server
appli	clpappli.dll	Application resource
appliw	clpapliw.dll	Application monitor resource
armdrive	armdrive.exe	Drive letter setting command
awsazw	clpawsazw.dll	AWS AZ monitor resource
awseip	clpawseip.dll	AWS elastic ip resource
awseipw	clpawseipw.dll	AWS elastic ip monitor resource
awsvip	clpawsvip.dll	AWS virtual ip resource
awsvipw	clpawsvipw.dll	AWS virtual ip monitor resource
azurepp	clpazurepp.dll	Azure probe port resource
azureppw	clpazureppw.dll	Azure probe port monitor resource
azurelbw	clpazurelbw.dll	Azure load balance monitor resource
bmc	clpbmc.dll	BMC HB library
bmccnf	clpbmccnf.exe	BMC information update command
bmchb	clpbmchb.dll	BMC heartbeat resource
bwctrl	clpbwctrl.exe	Cluster activation synchronization wait processing control command
cfctrl	clpcfctrl.exe	Cluster generation, cluster information and backup command
cl	clpcl.exe	Cluster startup and stop command
clpdnld	clpdnld.exe	Downloader
clpgetsvcstat	clptrnsv.exe	Transaction server
clpshmstat	clpshmstat.dll	Node status management library
clsv	clpclsv.dll	Client server
commcl	clpcommcl.dll	Common communication client library
comnp	clpcomnp.dll	COM network partition resolution resource
cpufreq	clpcpufreq.exe	CPU frequency control command
ddns	clpddns.dll	Dynamic DNS resources
ddnsw	clpddnsw.dll	Dynamic DNS monitor resources
diskagcl	clpdiskagcl.dll	Disk agent communication client
diskagent	clpdiskagent.exe	Disk agent
diskfltr	clpdiskfltr.dll	Disk filtering library
disknp	clpdisknp.dll	DISK network partition resolution resource
diskperf	clpdiskperf.dll	Disk performance log library
diskutil	clpdiskutil.dll	Mirror disk/disk shared library

Type	Module	Description
diskw	clpdiskw.dll	Disk RW monitor resource
down	clpdown.exe	Server shutdown command
event	clpevent.dll	Event log
exping	clpexpng.dll	PING execution management
fip	clpfip.dll	Floating IP resource
fipw	clpfipw.dll	Floating IP monitor resource
genw	genw.dll	Custom monitor resource
grp	clpgrp.exe	Group startup, stop, move, and migration command
hblog	clplanhb.dll	Kernel-mode LAN heartbeat resource
hd	clphd.dll	Hybrid disk resource
hdadm	clphdadmn.dll	Hybrid disk management library
hdapi	clphdapi.dll	Hybrid disk internal API
hddac	clphddac.dll	Hybrid disk control library
hdfunc	clphdfunc.dll	Hybrid disk function library
hdnm	clphdnm.dll	Hybrid disk node management
hdsnapshot	clphdsnapshot.exe	Hybrid disk snapshot backup command
hdtw	clphdtw.dll	Hybrid disk TUR monitor resource
hdw	clphdw.dll	Hybrid disk monitor resource
healthchk	clphealthchk.exe	Process health check command
ipw	clpipw.dll	IP monitor resource
lankhb	clplanhb.dll	Kernel-mode LAN heartbeat resource
lcns	clplcns.dll	License library
ledctrl	clpledctrl.exe	Chassis identify control command
logc	clplogcc.exe	Log collection library
logcc	clplogcc.exe	Collect logs command
logcf	clplogcf.exe	Log level and size modification command
logcmd	clplogcmd.exe	Alert producing command
mail	clpmail.exe	Mail Notification
majonp	clpmajnp.dll	Majority network partition resolution resource
md	clpmd.dll	Mirror disk resource
mdadm	clpmdadm.dll	Mirror disk management library
mdclose	mdclose.exe	Mirror disk resource close command
monctrl	clpmonctrl.exe	Monitor resource control command
mdfunc	clpmdfunc.dll	Mirror disk function library
mdnw	clpmdnw.dll	Mirror connect monitor resource
mdopen	mdopen.exe	Mirror disk resource open command
mdw	clpmdw.dll	Mirror disk monitor resource
mgmtagt	clpmgmtmib.dll	Library for SNMP Service
miiw	clpmiiw.dll	NIC Link Up/Down monitor resource

Type	Module	Description
monctrl	clpmonctrl.exe	Monitor resource control command
mrw	clpmrw.dll	Message receive monitor resource
mtw	clpmtw.dll	Multi target monitor resource
nm	clpnm.exe	Node map management
oldapi	clpoldapi.exe	Compatible API
oldapi_cnf	clpoldapi.exe	Compatible API
oldapi_evt	clpoldapi.exe	Compatible API
oldapi_if	clpoldapi.exe	Compatible API
oldapi_sts	clpoldapi.exe	Compatible API
pingnp	clppingnp.dll	PING network partition resolution resource
pm	clppm	Process management
pmsvc	clppmsvc.exe	Process management
psw	clppsw.dll	Process name monitor resource
ptun	clpptun.dll	Parameter tuning
ptunlib	clpptun.dll	Parameter tuning
rc	clprc.exe	Group and group resource management
rc_ex	clprc.exe	Group and group resource management
rd	clprd.exe	Process for smart failover
rdl	clprdl.dll	Library for smart failover
regctrl	clpregctrl.exe	Reboot count control command
regsync	clpregsync.dll	Registry synchronization resource
regsyncw	clpregsync.dll	Registry synchronization monitor resource
resdllc	clpresdllc.dll	Resource control library
rm	clprm.dll	Monitor management
script	clpscript.dll	Script resource
scrpc	clpscrpc.exe	Script
scrpl	clpscrpl.exe	Script
sd	clpsd.dll	Disk resource
sdadm	clpsdadm.dll	Disk management library
sddknp	clpsddknp.dll	DISK network partition resolution resource
sdfunc	clpsdfunc.dll	Disk function library
sdw	clpsdw.dll	Disk TUR monitor resource
sem	clpsem.dll	Semaphore library
service	clpservice.dll	Service resource
servicew	clpservicew.dll	Service monitor resource
shmcm	clpshmcm.dll	Shared memory library
shmevt	clpshmevt.dll	Event library
shmm	clpshmm.dll	Shared memory library
shmm	clpshmm.dll	Shared memory library

Type	Module	Description
snmpmgr	clpsnmpmgr.dll	SNMP trap reception library
spool	clpspool.dll	Print spooler resource
spoolw	clpspoolw.dll	Print spooler monitor resource
startup	clpstartup.exe	Startup
stat	clpstat.exe	Status display command
stdn	clpstdn.exe	Cluster shutdown command
toratio	clptoratio.exe	Time-out ratio modification command
trncl	clptrncl.dll	Transaction library
trap	claptrap.exe	SNMP trap command
trnreq	clptrnreq.exe	Inter-cluster processing request command
rexec	clprexec.exe	External monitoring link processing request command
trnsv	clptrnsv.exe	Transaction server
userw	clpuserw.dll	User space monitor resource
vcom	clpvcom.dll	Virtual computer name resource
vcomw	clpvcomw.dll	Virtual computer name monitor resource
vip	clpvip.dll	Virtual IP resource
vipw	clpvipw.dll	Virtual IP monitor resource
webalert	clpald.exe	Alert synchronization
webmgr	clpwebmc.exe	WebManager
xml	xlpxml.dll	XML library
vm	clpvm.dll	VM resource
vmw	clpvmw.dll	VM monitor resource
vmctrl	clpvmctrl.dll	VMCtrl library

Default log levels and log file sizes

Type	Level	Size (byte)
alert	4	1000000
apicl	4	5000000
apicl_rc	4	5000000
apisv	4	5000000
appli	4	1000000
appliw	4	1000000
armdrive	4	1000000
bmc	4	1000000
awsazw	4	1000000
awseip	4	1000000
awseipw	4	1000000
awsvip	4	1000000
awsvipw	4	1000000

Type	Level	Size (byte)
azurelbw	4	1000000
azurepp	4	1000000
azureppw	4	1000000
bmccnf	4	1000000
bmchb	4	1000000
bwctrl	4	1000000
cfctrl	4	1000000
cifs	4	1000000
cifsw	4	1000000
cl	4	1000000
clpdnld	4	1000000
clpgetsvcstat	4	1000000
clpshmstat	4	1000000
clsv	4	1000000
commcl	4	80000000
comnp	4	1000000
cpufreq	4	1000000
ddns	4	1000000
ddnsw	4	1000000
diskagcl	4	4000000
diskagent	4	10000000
diskfltr	4	1000000
disknp	4	1000000
diskperf	8	2000000
diskutil	4	1000000
diskw	4	1000000
down	4	1000000
event	4	1000000
exping	4	1000000
fip	4	1000000
fipw	4	1000000
genw	4	1000000
grp	4	1000000
hblog	4	1000000
hd	4	1000000
hdadm	8	1000000
hdapi	8	1000000
hddac	4	4000000
hdfunc	8	8000000

Type	Level	Size (byte)
hdnm	8	4000000
hdsnapshot	8	2000000
hdtw	4	1000000
hdw	4	2000000
healthcheck	4	1000000
ipw	4	1000000
lankhb	4	1000000
lcns	4	1000000
ledctrl	4	1000000
logc	4	1000000
logcc	4	1000000
logcf	4	1000000
logcmd	4	1000000
mail	4	1000000
majonp	4	1000000
md	4	1000000
mdadm	4	1000000
mdclose	4	1000000
mdctrl	4	1000000
mdfunc	4	2000000
mdnw	4	1000000
mdopen	4	1000000
mdw	4	1000000
mgmtagt	4	1000000
miiw	4	1000000
monctrl	4	1000000
mrw	4	1000000
mtw	4	1000000
nas	4	1000000
nasw	4	1000000
nm	4	2000000
oldapi	4	1000000
oldapi_cnf	4	1000000
oldapi_evt	4	1000000
oldapi_if	4	1000000
oldapi_sts	4	1000000
pingnp	4	1000000
pm	4	1000000
pmsvc	4	2000000

Type	Level	Size (byte)
psw	4	1000000
ptun	4	1000000
ptunlib	4	1000000
rc	4	5000000
rc_ex	4	5000000
rd	4	1000000
rdl	4	1000000
regctrl	4	1000000
regsync	4	1000000
regsyncw	4	1000000
resdllc	4	2000000
rm	4	5000000
script	4	1000000
scrpc	4	1000000
scrpl	4	1000000
sd	4	1000000
sdadm	4	1000000
sddknp	4	1000000
sdfunc	4	1000000
sdw	4	1000000
sem	4	1000000
service	4	1000000
servicew	4	1000000
shmcm	4	1000000
shmevt	4	1000000
shnm	4	1000000
shrm	4	1000000
snmpmgr	4	1000000
spool	4	1000000
spoolw	4	1000000
startup	4	1000000
stat	4	1000000
stdn	4	1000000
toratio	4	1000000
trap	4	1000000
trncl	4	2000000
trnsv	4	2000000
trnreq	4	1000000
userw	4	1000000

Type	Level	Size (byte)
rexec	4	1000000
vcom	4	1000000
vcomw	4	1000000
vip	4	1000000
vipw	4	1000000
webalert	4	1000000
webmgr	4	1000000
xml	4	1000000
vm	4	1000000
vmw	4	1000000
vmctrl	4	1000000
	Total	268000000 * 2

Monitoring Agent Types that can be specified for the -t option

Type	Module	Description
db2w	clp_db2w.dll	DB2 Monitor (Database Agent)
ftpw	clp_ftpw.dll	FTP Monitor (Internet Server Agent)
httpw	clp_httpw.dll	HTTP Monitor (Internet Server Agent)
imap4w	clp_imap4w.dll	IMAP4 Monitor (Internet Server Agent)
jra	clpjrasvc.exe	JVM monitor resource (Java Resource Agent)
jraw	clpjraw.dll	JVM monitor resource (Java Resource Agent)
odbcw	clp_odbcw.dll	ODBC Monitor (Database Agent)
oscw	clposcw.dll	OracleAS Monitor (Application Server Agent)
ossw	clpossw.dll	Oracle Monitor (Database Agent)
otxw	clposcw.dll	VB Corp CL Monitor (Anti-Virus Agent)
ossw	clpossw.dll	VB Corp SV Monitor (Anti-Virus Agent)
otxw	clp_otxw.dll	WebOTX Monitor (Application Server Agent)
smtpw	clp_smtpw.dll	POP3 Monitor (Internet Server Agent)
psqlw	clp_psqlw.dll	PostgreSQL Monitor (Database Agent)
tuxw	clp_tuxw.dll	SMTP Monitor (Internet Server Agent)
wasw	clp_wasw.dll	SQL Server Monitor (Database Agent)
sra	clpsraserviceproc.exe	System monitor resource (System Resource Agent)
sraw	clpsraw.dll	System monitor resource (System Resource Agent)
tuxw	clp_tuxw.dll	Tuxedo Monitor (Application Server Agent)
wasw	clp_wasw.dll	Websphere Monitor (Application Server Agent)
wlsw	clp_wlsw.dll	Weblogic Monitor (Application Server Agent)

Monitoring Agent Default Values of Log Level/Log File Size

Type	Level	Size (byte)
db2w	4	1000000

ftpw	4	1000000
httpw	4	1000000
imap4w	4	1000000
jra	4	1000000
jraw	4	1000000
odbcw	4	1000000
oracleasw	4	1000000
oraclew	4	1000000
oscw	4	1000000
ossw	4	1000000
otw	4	1000000
pop3w	4	1000000
psqlw	4	1000000
smtpw	4	1000000
sqlserverw	4	1000000
sra	8	1000000
sraw	4	1000000
tuxw	4	1000000
wasw	4	1000000
wls	4	1000000
	Total	21000000 * 2

Registering the license (clplcncsc command)

clplcncsc: the `clplcncsc` command registers the license.

Command line

```
clplcncsc -i <licensefile >
```

Description	Registers the product version or trial version license of this product.	
Option	-i	Registers the license provided by the specified license file.
Return Value	0	Success
	Other than 0	Failure
Notes	Run this command as a user with Administrator privileges. This command cannot register the license by specifying its information. Therefore, when registering the license by using this command, be sure to specify the license file.	
Example of command execution	<p>Example : When registering the license by specifying its license file(c:\tmp\licensefile)</p> <pre># clplcncsc -i c:\tmp\licensefile</pre>	

Error Message

Message	Cause/Solution
Log in as administrator.	Log on as a user with Administrator privileges.
Invalid parameter.	Specify a valid option.
License file is not found. filename=%s	The specified license file is not found. Specify a correct license file.
License information invalid.	The specified license file is invalid. Specify a correct license file.
License registration failure.	The license registration failed. Check if the memory or OS resources are sufficient.

Mirror-related commands

Displaying the mirror status (clpmdstat command)

clpmdstat: the `clpmdstat` command displays status related to mirroring and configuration information.

Command line:

```
clpmdstat {-m|--mirror} mirrordisk-alias
clpmdstat {-a|--active} mirrordisk-alias
clpmdstat {-d|--detail} mirrordisk-alias
clpmdstat {-l|--list}
clpmdstat {-c|--connect} mirrordisk-alias
```

Description	This command displays the status related to mirroring. This command displays mirror disk resources configuration information.		
Option	<code>-m, --mirror</code>	<code>--mirror</code>	Displays mirror disk resource status.
	<code>-a, --active</code>	<code>--active</code>	Displays status of mirror disk activation.
	<code>-d, --detail</code>	<code>--detail</code>	Displays mirror disk resources configuration information.
	<code>-l, --list</code>	<code>--list</code>	Displays a list of mirror disk resources.
	<code>-c, --connect</code>	<code>--connect</code>	Displays the mirror connect status.
Parameter	<code><i>mirrordisk-alias</i></code>	<code><i>mirrordisk-alias</i></code>	Specifies a mirror disk resource name.
Return value	0	Success	
	Other than 0	Failure	
Notes	Run this command as a user with Administrator privileges. In the case where the mirror disk resource is deactivated in the server on which the command is run, a warning message “Trying again to disconnect mirror disk” appears when the command is executed in the environment where processes other than EXPRESSCLUSTER access to the volume. (The command is executed successfully.)		
Example display after running this command	An example of the display after running this command is provided in the next section.		

Error Messages

Message	Cause/Solution
clpmdstat failed. An internal error occurred.	Check if the memory or OS resources are sufficient.
clpmdstat failed. A network error occurred.	Check the connection status of the interconnect.
clpmdstat failed. The resource name is invalid.	Specify the valid mirror disk resource name.
clpmdstat failed in the internal processes(****). The error code is %3.	Reboot the local server.

Display examples

- ◆ Displaying the status of mirror disk resource

The status of specified mirror disk resource is displayed by specifying the `-m` or `--mirror` option. There are three types of display depending on the status of mirror disk resource:

- When the status of mirror disk resource is Normal:

Mirror Status: Normal

```

mdl                server1                server2
-----
Mirror Color       GREEN                GREEN
Fast Copy         NG                  NG
Needed Copy Percent 1%                 1%
Volume Used Percent 64%                60%
Volume Size       10240MB            10240MB
  
```

Mirror disk resource name Server name Server name

Explanation of each item

Item	Description												
Mirror Status	Status of mirror disk resource												
	<table border="1"> <thead> <tr> <th>Status</th> <th>Description</th> </tr> </thead> <tbody> <tr> <td>Normal</td> <td>Normal</td> </tr> <tr> <td>Recovering</td> <td>Mirror is recovering</td> </tr> <tr> <td>Abnormal</td> <td>Abnormal</td> </tr> <tr> <td>No Construction</td> <td>Initial mirror construction is not done</td> </tr> </tbody> </table>	Status	Description	Normal	Normal	Recovering	Mirror is recovering	Abnormal	Abnormal	No Construction	Initial mirror construction is not done		
	Status	Description											
	Normal	Normal											
	Recovering	Mirror is recovering											
Abnormal	Abnormal												
No Construction	Initial mirror construction is not done												
Mirror Color	Status of mirror disk on each server												
	<table border="1"> <thead> <tr> <th>Status</th> <th>Description</th> </tr> </thead> <tbody> <tr> <td>GREEN</td> <td>Normal</td> </tr> <tr> <td>YELLOW</td> <td>Mirror is recovering</td> </tr> <tr> <td>RED</td> <td>Abnormal</td> </tr> <tr> <td>GRAY</td> <td>Being stopped, Unknown status</td> </tr> <tr> <td>BLUE</td> <td>Both disks are active</td> </tr> </tbody> </table>	Status	Description	GREEN	Normal	YELLOW	Mirror is recovering	RED	Abnormal	GRAY	Being stopped, Unknown status	BLUE	Both disks are active
	Status	Description											
	GREEN	Normal											
	YELLOW	Mirror is recovering											
	RED	Abnormal											
GRAY	Being stopped, Unknown status												
BLUE	Both disks are active												
Fast Copy	Indicates whether differential copy is enabled												
	<table border="1"> <thead> <tr> <th>Status</th> <th>Description</th> </tr> </thead> <tbody> <tr> <td>OK</td> <td>Differential copy is enabled</td> </tr> <tr> <td>NG</td> <td>Differential copy is disabled</td> </tr> <tr> <td>--</td> <td>Status is unknown</td> </tr> </tbody> </table>	Status	Description	OK	Differential copy is enabled	NG	Differential copy is disabled	--	Status is unknown				
	Status	Description											
	OK	Differential copy is enabled											
NG	Differential copy is disabled												
--	Status is unknown												
Needed Copy Percent	Percentage of the amount of the volume to be copied again												
Volume Used Percent	Percentage of volume usage												
Volume size	The size of the volume												

- When the status of mirror disk resource is abnormal

Mirror Status: Abnormal

```

mdl                server1                server2
-----
Mirror Color       GREEN                RED
Fast Copy          NG                  NG
Lastupdate Time   2004/02/24 15:41:07 --
Break Time        2004/02/24 15:40:38 --
Disk Error        OK                  OK
Needed Copy Percent 1%                  1%
Volume Used Percent 64%                 60%
Volume Size       10240MB            10240MB
    
```

Explanation of each item

Item	Description	
Mirror Status	Status of mirror disk resource *1	
Mirror Color	Status of mirror disk on each server *1	
Lastupdate Time	Last time when the data was updated on the server.	
Break Time	Time when mirror break has occurred	
Disk Error	Status of disk I/O	
	Status	Description
	OK	Normal
	ERROR	Error (No I/O)
	--	Unknown
Needed Copy Percent	Percentage of the amount of the volume to be copied again	
Volume Used Percent	Percentage of volume usage	
Volume size	The size of the volume	

*1 Refer to “When the status of mirror disk resource is Normal:.”

- During mirror recovery

Mirror Status: Recovering

```
md1                server1                server2
-----
Mirror Color        YELLOW                YELLOW

Recovery Status    Value
-----
Status:            Recovering
Direction:         server1 -> server2
Percent:           15%
Used Time:         00:00:21
Remain Time:       00:01:59
```

Explanation of each item

Item	Description										
Mirror Status	Status of mirror disk resource *1										
Mirror Color	Status of mirror disk on each server *1										
Status	<p>Status of mirror recovery</p> <table border="1"> <thead> <tr> <th>Status</th> <th>Description</th> </tr> </thead> <tbody> <tr> <td>Preparing</td> <td>Preparing for copy (This status may last for a while if I/O load is high when resource is getting started during recovery)</td> </tr> <tr> <td>Recovering</td> <td>Being recovered</td> </tr> <tr> <td>Completing</td> <td>Recovering is being completed</td> </tr> <tr> <td>Nothing</td> <td>Canceling recovery</td> </tr> </tbody> </table>	Status	Description	Preparing	Preparing for copy (This status may last for a while if I/O load is high when resource is getting started during recovery)	Recovering	Being recovered	Completing	Recovering is being completed	Nothing	Canceling recovery
Status	Description										
Preparing	Preparing for copy (This status may last for a while if I/O load is high when resource is getting started during recovery)										
Recovering	Being recovered										
Completing	Recovering is being completed										
Nothing	Canceling recovery										
Direction	Direction of mirror recovery Display either [source server] -> [destination server] , or [destination server] <- [source server]										
Percent	Percentage of how much data is already recovered										
Used Time	Elapsed time since recovering has started										
Remain Time	Estimated time to complete recovering the remaining data. It is estimated by the speed of already recovered data. The time may be different depending on server load.										

*1 Refer to "• When the status of mirror disk resource is Normal:".

◆ Displaying active status of mirror disk resource

Active status of the specified mirror disk resource is displayed when the `-a` or `--active` option is specified:

```
Mirror Name: md1

Server Name      Active Status
-----
server1          Active
server2          Inactive
```

Status of mirror partition device

Active Status	Description
Active	Active
Inactive	Not active
--	Unknown

◆ Displaying mirror disk resource information

Configuration information of the specified mirror disk resource is displayed when the `-d` or `--detail` option is specified:

```
Mirror Name: md1

Server Name      Drive Letter      NMP/Disk Size
-----
server1          F:                1024MB/1024MB
server2          F:                1024MB/1024MB
```

Explanation of each item

Item	Description
Mirror Name	Mirror disk resource name
Server Name	Server name
Mount Point	Mount point
Drive Letter	Data partition drive letter
NMP/Disk Size(MB)	NMP: the smaller size of data partition of servers Disk Size: actual data partition size

◆ Displaying the list of mirror disk resources

The list of mirror disk resources is displayed when the `-l` or `--list` option is specified.

```

Mirror Name      Server Name      Drive Letter
-----
md1              server1          F:
                 server2          F:
md2              server1          G:
                 server2          G:
    
```

Explanation of each item:

Item	Description
Mirror Name	Mirror disk resource name
Server Name	Server name
Drive Letter	Data partition drive letter

◆ Displaying the mirror connect status

When the `-c` or `--connect` option is specified, the mirror connect status is displayed.

An example of a two-node MD is given below.

- The resource is active on Server1. (The currently used mirror disk connect has Priority1, and the next mirror disk connect to be connected has Priority2.)

```

Resource Name      : md01
Number of Connection : 2

Mirror Connect      Priority1      Priority2
-----
Server1
Address             10.0.10.11    10.0.20.11
Status              Active         Standby
Server2
Address             10.0.10.12    10.0.20.12
Status              Active         Standby
    
```

- The resource is in the standby status on both servers. (There is no currently used mirror disk connect, and the next mirror disk connect to be connected has Priority1.)

```

Resource Name      : md01
Number of Connection : 2

Mirror Connect      Priority1      Priority2
-----
Server1
Address             10.0.10.11    10.0.20.11
Status              Standby        Standby
Server2
Address             10.0.10.12    10.0.20.12
Status              Standby        Standby
    
```

- Only one mirror disk connect is set up. (The resource is active on Server1.)

```
Resource Name      : md01
Number of Connection : 1

Mirror Connect    Priority1      Priority2
-----
Server1
  Address         10.0.10.11      --
  Status          Active           --
Server2
  Address         10.0.10.12      --
  Status          Active           --
```

- Server2 is in the error status. (The mirror disk connect status of Server2 cannot be acquired, and the resource is active on Server1.)

```
Resource Name      : md01
Number of Connection : 2

Mirror Connect    Priority1      Priority2
-----
Server1
  Address         10.0.10.11      10.0.20.11
  Status          Error           Error
Server2
  Address         10.0.10.12      10.0.20.12
  Status          Unknown          Unknown
```

Explanation of each item

Item name	Description	
Resource Name	Mirror disk resource name	
Number of Connection	Number of mirror disk connects	
Address	IP address of the mirror disk connect (primary and secondary) The values specified in the Builder are referenced.	
Status	Status of the mirror disk connect (primary and secondary) (Operation status and presence of any error such as a disconnection or connection error)	
	String	Status of the mirror disk connect
	Active	Being used
	Standby	Not used and on standby (There is no error and the connect is available for communication.)
	Error	Not used and disconnected (There is an error and the connect is not available for communication.)
	Unknown	Unknown
	--	No configuration data

Operating mirror disk resource (clpmdctrl command)

clpmdctrl: the `clpmdctrl` command operates mirror disk resources.

Command line:

```
clpmdctrl {-a|--active} mirrordisk-alias
clpmdctrl {-d|--deactivate} mirrordisk-alias
clpmdctrl {-b|--break} mirrordisk-alias
clpmdctrl {-f|--force} recovery-source-servername mirrordisk-alias
clpmdctrl {-r|--recovery} mirrordisk-alias[-f, -a, or -vf]
clpmdctrl {-c|--cancel} mirrordisk-alias
clpmdctrl {-w|--rwait} mirrordisk-alias [-timeout time] [-rcancel]
clpmdctrl {-s|--mdcswitch} mirrordisk-alias[priority-number]
clpmdctrl {-p|--compress} [mirrordisk-alias]
clpmdctrl {-n|--nocompress} [mirrordisk-alias]
```

Note:

Do not use the `-a`, `--active`, and `-d`, `--deactivate` options when the EXPRESSCLUSTER service is started. If you use them, there will be an error.

Description	This command activates/deactivates mirror disk resource and recovers mirror.	
Option	<code>-a, --active</code>	Activates the mirror disk resource on the local server. If the status of mirror disk resource is normal, mirroring is performed. If the status of mirror disk resource is not normal, mirroring will not be performed.
	<code>-d, --deactivate</code>	Deactivates the activated mirror disk resource on the local server.
	<code>-b, --break</code>	Stops mirroring of the mirror disk and makes the data status not to be the latest on the server where the command is executed. The status of the mirror disk resource on the server that the command is executed becomes abnormal. The status of the mirror disk resource remains the same as long as the command is not executed on the server. Mirroring restarts when mirror recovery is executed. The mirror data is not synchronized until mirror recovery is executed if mirror writing occurs.
	<code>-f, --force</code>	Forcefully performs mirror recovery for the specified mirror disk resource.
	<code>-r, --recovery</code>	Performs either full mirror recovery or differential mirror recovery for the specified mirror disk resource with the local server as the copy source. Whether to perform full or differential mirror recovery is determined automatically.
	<code>-f</code>	Copies all the used area of a volume if the used area can be identified. Copies the entire area of a volume if the used area

		cannot be identified.
		This cannot be specified when <code>-a</code> or <code>-vf</code> is specified.
	<code>-a</code>	Automatically selects the recovery mode.
		Performs differential copying if the different parts can be identified. If differences cannot be identified, the command behaves in the same way as when <code>-f</code> is specified.
		This cannot be specified when <code>-f</code> is specified. When neither <code>-f</code> or <code>-a</code> is specified, the recovery mode is automatically selected.
		This cannot be specified when <code>-f</code> or <code>-vf</code> is specified.
	<code>-vf</code>	Copies the entire area of a volume regardless of differences and the used area.
		This cannot be specified when <code>-a</code> or <code>-f</code> is specified.
	<code>-c, --cancel</code>	Cancels mirror recovery.
	<code>-w, --rwait</code>	Waits the completion of the mirror recovery of the specified mirror disk resource.
	<code>-timeout</code> <i>time</i>	Specifies the timeout period of mirror recovery completion (second). This option can be omitted. When this option is omitted, timeout is not executed and waits for the completion of mirror recovery.
	<code>-rcancel</code>	Intermits mirror recovery when the timeout of waiting of mirror recovery completion occurred. This option can be set when <code>-timeout</code> option is set. When this option is omitted, the mirror recovery continues even after the timeout occurrence.
	<code>-s, --mdcswitch</code>	Switches between the primary and secondary mirror disk connects of the user-specified disk resource. If the priority number is omitted, the secondary mirror disk connect is switched to when the primary mirror disk connect is used at the time of command execution. When the secondary mirror disk connect is used, the primary mirror disk connect is switched to. If the priority numbers are specified, the mirror disk connect that has the appropriate priority number is switched to.
	<code>-p, --compress</code>	Temporarily enables mirror data compression for the specified disk resource. If the mirror disk resource name is omitted, mirror data compression is temporarily enabled for all mirror disk resources.
	<code>-n, --nocompress</code>	Temporarily disables mirror data compression for the specified disk resource. If the mirror disk resource name is omitted, mirror data compression is temporarily disabled for all mirror disk resources.
Parameter	<i>recovery-source-servername</i>	Specify a server name of the copy source.
	<i>mirrordisk-alias</i>	Specify a mirror disk resource name.
	<i>priority-number</i>	Specify the priority number (1 or 2).

Return Value	0	Success
	1	Invalid parameter
	3	Other error
	4	Target mirror disk is not configuring mirror, or the mirror configuring failed on the process. (Only when <code>-w</code> or <code>--rwait</code> option is specified, including the case when mirror recovery is interrupted by <code>-c</code> or <code>-rcancel</code> .)
	5	Timeout of mirror recovery of target mirror disk occurs (Only when <code>-w</code> or <code>--rwait -timeout</code> option is specified)
	6	The status of the destination mirror disk connect is invalid (only when the <code>-s</code> or <code>--mdcswitch</code> option is specified).
	7	Only one mirror disk connect is set up (only when the <code>-s</code> or <code>--mdcswitch</code> option is specified).
	8	The remote server is down (only when the <code>-s</code> or <code>--mdcswitch</code> option is specified).
Remarks	This command returns control when the specified processing starts. Run the <code>clpmdstat</code> command to check the processing status.	
Notes	<p>Run this command as a user with Administrator privileges.</p> <p>When performing forced mirror recovery only for the local server while the remote server is not running, specify the server that is forcefully mirror recovered as a copy source.</p> <p>When performing mirror recovery again after mirror recovery failed, specify the same server you used last time for mirror recovery as a copy source.</p> <p>To resume the forced mirror recovery that was suspended by selecting Cancel, use this command for forced mirror recovery.</p>	
Example of command execution	<p>Example 1: When activating the mirror disk resource <code>md1</code>:</p> <pre># clpmdctrl --active md1</pre> <p><md1@server1>: active successfully</p> <p>Example 2: When deactivating the mirror disk resource <code>md1</code>:</p> <pre># clpmdctrl --deactive md1</pre> <p><md1@server1>: deactivate successfully</p> <p>Example 3: When mirror recovering the mirror disk resource <code>md1</code>:</p> <pre># clpmdctrl --recovery md1</pre>	

Error Messages

Message	Cause/Solution
clpmdctrl failed. An internal error occurred.	Check if the memory or OS resources are sufficient.
clpmdctrl failed. The resource is busy.	The partition may be being used. Try again later.
clpmdctrl failed. A network error occurred.	Check the connection status of the interconnect.
clpmdctrl failed. Cannot establish the mirror disk connection.	Check if the cluster configuration data is valid.
clpmdctrl failed. The resource name is invalid.	Specify the valid mirror disk resource name.
clpmdctrl failed. The status is invalid.	Check the mirror disk status.
clpmdctrl failed. The resource is not initialized.	Check if the partition is allocated and the disk can be identified by OS. Check also that the cluster configuration data is valid.
clpmdctrl failed. The resource has not performed initial mirror construction.	Initial mirror configuration is necessary.
clpmdctrl failed. Cannot lock the mirror disk.	Check if the memory or OS resources are sufficient.
clpmdctrl failed. The license is not registered.	Register the license.
clpmdctrl failed. The trial version has expired.	Register the license.
clpmdctrl failed. The license authentication failed.	Register the license.
clpmdctrl failed. Cannot find the history folder.	Check if the cluster configuration data is valid.
clpmdctrl failed. The partition size between servers does not match.	Check the partition size of the mirror disk.
clpmdctrl failed. The mirror connect is not initialized.	Check the connection status of the mirror connect. Check also that the cluster configuration data is valid.
clpmdctrl failed. Cannot find the partition specified for the cluster partition.	Check if the partition is allocated and the disk can be identified by OS.
clpmdctrl failed. Cannot find the partition specified for the data partition.	Check if the partition is allocated and the disk can be identified by OS.
clpmdctrl failed. Cannot change the drive letter for the cluster partition.	Check the drive letter specified to the cluster configuration data. Check if the drive letter has already been used by other partition.
clpmdctrl failed. Cannot change the drive letter for the data partition.	Check the drive letter specified to the cluster configuration data. Check if the drive letter has already been used by other partition.
clpmdctrl failed. The server name is invalid.	Specify the valid server name.

Message	Cause/Solution
clpmdctrl failed. %2 is running.	Execute while EXPRESSCLUSTER Server is being stopped.
clpmdctrl failed. The mirror disk [<i>MD resource name</i>] can not be controlled on this server.	Check the mirror disk status.
clpmdctrl failed. The mirror disk [<i>MD resource name</i>] is not copying.	Check the mirror disk status.
clpmdctrl failed in the internal processes(%2). The error code is %3.	Reboot the local server.
[<i>MD resource name</i>] status is invalid.	Target mirror disk is not configuring mirror, or the mirror configuring failed on the process.
[<i>MD resource name</i>] mirror recovery timed out.	Check if the specified timeout period is appropriate, or if the disk I/O or communication delay is not occurring due to heavy loads.
The status of the mirror connect to be switched to is invalid.	Check the connection status of the mirror disk connect.
Only one mirror connect is set up.	Make sure that more than one mirror disk connect is registered.
The remote service is down.	Check the server operating status.

Tuning partition size (clpvolsz command)

clpvolsz: the `clpvolsz` command enlarges and shrinks the disk partition size.

Command line:

```
clpvolsz drive-letter [size]
```

Description This command checks the sizes of data partitions mirrored by mirror disk resource. If the partitions are not of the same size, the command adjusts the sizes.

Parameter

<i>drive-letter</i>	Specify the drive letter of the target partition drive.
<i>size</i>	Specify the partition size by byte. If nothing is specified, the current size is displayed.

Return value

0	succeeded in displaying the size
1	succeeded in changing the size
2 or greater	abnormal

Notes Run this command as a user with Administrator privileges.

You cannot extend the partition size by this command.

Shrinking the partition size by using this command may cause the change of the drive letter. After shrinking the partition size, make sure to use Disk Management. (Navigate from Control Panel to Administrative Tools, Computer Management, Disk Management) to rescan the disk and check the drive letter and configure as necessary.

When the target partition has been registered as data partition/cluster partition in the cluster configuration information of the mirror disk resource, delete the mirror disk resource before shrinking the partition size and register again after shrinking and reconfiguration of drive letter.

The partition size is coordinated by MBR. Typically, it is a multiple of 512 bytes.

Examples Example 1 : When checking the Z drive size

```
# clpvolsz z:
Drive <z:> 8,587,160,064
```

Example 2: When shrinking the Z drive size to 8,587,159,552Byte

```
# clpvolsz z: 8587159552
Drive <z:> 8,587,160,064 -> 8,587,159,552
Execute it? [Y/N] ->y
```

```
SUCCESS
```

Error messages

Message	Causes/Solution
ERROR:invalid parameter.	The parameter is incorrect. Check the number of arguments and formats are set correctly.
ERROR:larger than partition size.	The value larger than the current partition size is set. Specify a smaller value.
ERROR:drive not found.	The specified drive is not found. Check if you have specified the right drive.
ERROR:drive open failed.	The specified drive cannot be opened. Check if the drive can be accessed.
ERROR:partition not found.	The partition number on the specified drive cannot be found. Check if you have checked the right driver.
ERROR:partition size zero.	The partition size of the specified server is 0. Check if the target partition is a basic volume.
ERROR:device layout info.	Acquiring disk partition configuration information has failed. Check if the target partition is a basic volume.
ERROR:device geometry info.	Acquiring the disk geometry information has failed. Check if the disk device is working properly.
ERROR:device no info.	Acquiring Device No. / Partition No has failed. Check the target partition is a basic volume.
ERROR:set device info.	Configuration of partition information has failed on the disk. Check if writing to disks is not prohibited.
ERROR:memory alloc error.	Reserving the resource has failed. Check if the memory or OS resource is enough.

Controlling disk access (clpvolctrl command)

clpvolctrl: Accesses a volume not registered as a resource.

Command line:

```
clpvolctrl {-o|--open} drive_name
clpvolctrl {-c|--close} drive_name
clpvolctrl {-v|--view} [drive_name]
clpvolctrl --view
```

Description Accesses a disk volume not registered as a resource under an HBA for which filtering is set up.

Option	-o, --open	Permits access to a volume not registered as a resource. Specify the drive name of the volume to which you want to permit access.
	-c, --close	Restricts access to a volume not registered as a resource. Specify the drive name of the volume to which you want to restrict access.
	-v, --view	Displays the status of access to a volume not registered as a resource. Specify the drive letter of the volume whose access status you want to display. - When a drive letter is specified The status of access to the specified volume is displayed. - When a drive letter is not specified (default) The command displays the access status of all volumes not registered as resources on a disk that belongs to the server executing the command and that is connected to an HBA for which filtering is set up.
Parameter	<i>drive_name</i>	Specify the drive letter of the target volume.
Return value	0	The command is successfully executed.
	101	Invalid Parameters
	102	The target volume is already registered as a resource.
	103	Access to the target volume is already permitted (only when the -o or --open option is used).
	104	Access to the target volume is already restricted (only when the -c or --close option is used).
	200	Other errors

- Notes** This command must be executed by a user with the administrator privilege.
- Examples**
- Example 1: This example shows how to permit access to a volume not registered as a resource:
- ```
#clpvolctrl --open z:
Command succeeded.
```
- Example 2: This example shows how to restrict access to a volume not registered as a resource:
- ```
# clpvolctrl --close z:
Command succeeded.
```
- Example 3: The examples below show how to display the status of access to a volume not registered as a resource.
- a) When a drive letter is specified:
- ```
clpvolctrl --view z:
Drive Name Access Status

z open
```
- b) When a drive letter is not specified:
- ```
# clpvolctrl --view:
Drive Name  Access Status
-----
w           open
x           close
y           close
z           open
```

Error messages

Message	Causes/Solution
Invalid parameter.	Check if there is any error in its format or parameter.
[drive name]: is a volume registered as a resource.	Check whether a group resource is using the specified drive.
Access to [drive name]: is already permitted.	The command has been executed with the <code>-o</code> or <code>--open</code> option for a drive to which access is already permitted.
Access to [drive name]: is already restricted.	The command has been executed with the <code>-c</code> or <code>--close</code> option for a drive to which access is already prohibited.
Internal error. The error code is <i>[error code]</i> .	Restart the local server.

Operating snapshot backup of hybrid disk resource (clphdsnapshot command)

clphdsnapshot: the `clphdsnapshot` is used for operating hybrid disk resource snapshot.

Command line:

```
clphdsnapshot {-o|--open} hybriddisk-alias
clphdsnapshot {-c|--close} hybriddisk-alias
```

Description	This command interrupts the mirroring of hybrid disk resource and cancels the data partition access restriction to allow collection of snapshot backup, and then resumes ordinary status by resuming mirroring.	
Option	<code>-o, --open</code>	Interrupts mirroring and allows collecting the snapshot backups on the server on which the command is executed by cancelling the data partition access restriction, and then resumes mirroring. When the auto mirror recovery is set to be enabled, this setting is made to disable temporarily.
	<code>-c, --close</code>	Restricts access to the data partition. If the auto mirror recovery is set to be enabled, the disablement is canceled and then, mirroring is resumed.
Parameter	<i>hybriddisk-alias</i>	Specifies the hybrid disk resource name.
Return Value	0	The command is successfully executed.
	1	Invalid parameter.
	2	The target resource is not mirrored (only when using the <code>-o</code> or <code>--open</code> option).
	3	The target resource is already in the snapshot status on other server, or forcibly activated (only when using the <code>-o</code> or <code>--open</code> option.).
	4	The target resource is already in the snapshot status (only when using the <code>-o</code> or <code>--open</code> option).
	5	The target resource is not in the snapshot status (only when using the <code>-c</code> or <code>--close</code> option).
	6	The target resource is now on mirror recovery.
	7	The target resource does not exist in local server.
	8	The command is executed on the active server group.
	9	Other errors

Notes

This command must be executed by the user with administrator privilege.

This command should be executed on one of the standby server group which works as a copy destination of mirroring for the active hybrid disk resource that is properly mirrored. This command cannot be executed on a server in active server group (i.e., server in the same group as the server whose resources are activated).

When mirroring is interrupted using this command, note that the data at the mirroring copy destination does not necessarily have integrity as NTFS or application data, depending on the timing of the mirroring.

Example of command execution

The following shows how backup of the Z drive which is mirrored at the hybrid disk resource hd_Z is collected.

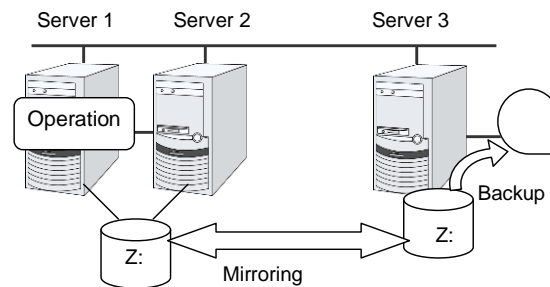

1. Execute the command below on the server 3 in the standby server group.

```
# clphdsnapshot --open hd_Z
Command succeeded.
```

2. Collect backup of the Z drive at the server 3 by using the backup tool.

3. Execute the command below on the server 3.

```
# clphdsnapshot --close hd_Z
Command succeeded.
```

4. When the auto mirror recovery is set to be disabled, run the mirror recovery manually.

Error Messages

Message	Cause/Solution
Invalid parameter.	The parameter is invalid. Check if there is any error in its format or parameter.
%1 is not mirroring, or not active.	Snapshot backup cannot be performed on a hybrid disk resource which is deactivated or is not mirrored. Try again after activating the resource on another server group and while the mirroring is performed.
%1 is busy on %2	Check that the target resource is already in the snapshot status on another server in the same server group, or is not forcefully activated.
%1 has already opened.	The command is executed by specifying the <code>-o</code> or <code>--open</code> option for the resource that is already been in the snapshot status. Check the execution procedures.
%1 is not open.	The command is executed with the <code>-c</code> or <code>--close</code> option for the resource that is not in snapshot status by the <code>-o</code> or <code>--open</code> option. Make sure that the command with the <code>-o</code> or <code>--open</code> option has been executed successfully.
%1 is copying.	A snapshot backup cannot be performed for the hybrid disk resource in the process of mirror recovery. Try again after the mirror recovery has been completed.
%1 is not available to %2.	Snapshot backups cannot be collected on a server on which the target resource cannot be activated. Execute it on a server on which the failover group containing this resource can be started.
Don't execute at active server group.	Snapshot backup cannot be performed on a hybrid disk resource that is already activated in another server in the same server group. Execute it on a server in the standby server group.
Internal error. %1	Check the status of the cluster partition/data partition of the target resource. Make sure that memory or OS resource is sufficient.

Displaying the hybrid disk status (clphdstat command)

clphdstat: the `clphdstat` command displays the status and configuration information on hybrid disk.

Command line

```
clphdstat {-m|--mirror} hybriddisk-alias
clphdstat {-a|--active} hybriddisk-alias
clphdstat {-l|--config}
clphdstat {-c|--connect} hybriddisk -alias
```

Description This command displays various status on hybrid disk and the configuration information on hybrid disk resource.

Option	<code>-m, --mirror</code>	Displays the status of hybrid disk resource.
	<code>-a, --active</code>	Displays the activation status of hybrid disk resource.
	<code>-l, --config</code>	Displays the configuration information on hybrid disk resource.
	<code>-c, --connect</code>	Displays the mirror connect status.

Parameter *hybriddisk-alias* Specifies the hybrid disk resource name.

Return Value	0	Success
	Other than 0	Failure

Notes This command must be executed by the user with administrator privilege.

In the case where the hybrid disk resource is deactivated in the server on which the command is run, a warning message “Trying again to disconnect hybrid disk” appears when the command is executed in the environment where processes other than EXPRESSCLUSTER access to the volume. (The command is executed successfully.)

Example of command display See the next section for command display examples.

Error Message

Message	Cause/Solution
Invalid parameter.	The parameter is invalid. Check if there is any error in its format or parameter.
All servers are down.	Check that at least one server having the target hybrid disk resource is operating, and then execute the command again.
Internal error. %1	Restart the local server.

Display examples

◆ Hybrid disk resource status display

When the `-m` or `--mirror` option is specified, the status of the specified hybrid disk resource is displayed.

There are two types of hybrid disk resource status display depending on the hybrid disk resource status.

- When the hybrid disk resource status is other than Recovering

```

Status:                Abnormal

hd01                    svg01                    svg02
-----
Mirror Color            GREEN                    RED
Fast Copy               OK                    OK
Lastupdate Time        --                    2008/05/27 15:50:27
Break Time             --                    2008/05/27 15:44:35
Needed Copy Percent    68%                    68%
Volume Used Percent    67%                    63%
Volume Size            1024MB                    1024MB
Disk Error             NO ERROR                    ERROR

Server Name            DP Error                    CP Error
-----
server1                NO ERROR                    NO ERROR
server2                NO ERROR                    NO ERROR
server3                ERROR                        NO ERROR
server4                NO ERROR                    ERROR
  
```

Hybrid disk resource name Server group name

Description on each item

Item Name	Description														
Status	Hybrid disk resource status														
	<table border="1"> <thead> <tr> <th>Status</th> <th>Description</th> </tr> </thead> <tbody> <tr> <td>Normal</td> <td>Normal</td> </tr> <tr> <td>Recovering</td> <td>Mirror is being recovered</td> </tr> <tr> <td>Abnormal</td> <td>Abnormal</td> </tr> <tr> <td>No Construction</td> <td>Mirror initial construction has not been performed</td> </tr> <tr> <td>Uncertain</td> <td>Unknown status or undefined of new/old</td> </tr> </tbody> </table>	Status	Description	Normal	Normal	Recovering	Mirror is being recovered	Abnormal	Abnormal	No Construction	Mirror initial construction has not been performed	Uncertain	Unknown status or undefined of new/old		
	Status	Description													
	Normal	Normal													
	Recovering	Mirror is being recovered													
	Abnormal	Abnormal													
	No Construction	Mirror initial construction has not been performed													
Uncertain	Unknown status or undefined of new/old														
Mirror Color	Hybrid disk status in each server														
	<table border="1"> <thead> <tr> <th>Status</th> <th>Description</th> </tr> </thead> <tbody> <tr> <td>GREEN</td> <td>Normal</td> </tr> <tr> <td>YELLOW</td> <td>Mirror is being recovered</td> </tr> <tr> <td>RED</td> <td>Abnormal</td> </tr> <tr> <td>ORANGE</td> <td>Undefined of new/old</td> </tr> <tr> <td>GRAY</td> <td>Stopped or Unknown</td> </tr> <tr> <td>BLUE</td> <td>Both systems are active</td> </tr> </tbody> </table>	Status	Description	GREEN	Normal	YELLOW	Mirror is being recovered	RED	Abnormal	ORANGE	Undefined of new/old	GRAY	Stopped or Unknown	BLUE	Both systems are active
	Status	Description													
	GREEN	Normal													
	YELLOW	Mirror is being recovered													
	RED	Abnormal													
	ORANGE	Undefined of new/old													
	GRAY	Stopped or Unknown													
BLUE	Both systems are active														
Fast Copy	Indicates whether differential copy is enabled														
	<table border="1"> <thead> <tr> <th>Status</th> <th>Description</th> </tr> </thead> <tbody> <tr> <td>OK</td> <td>Differential copy is enabled</td> </tr> <tr> <td>NG</td> <td>Differential copy is disabled</td> </tr> <tr> <td>--</td> <td>Status is unknown</td> </tr> </tbody> </table>	Status	Description	OK	Differential copy is enabled	NG	Differential copy is disabled	--	Status is unknown						
	Status	Description													
	OK	Differential copy is enabled													
	NG	Differential copy is disabled													
--	Status is unknown														
Lastupdate Time	Time when the data was last updated on the server														
Break Time	Time when mirror break occurred														
Needed Copy Percent	Percentage of the amount of the volume to be copied again														
Volume Used Percent	Percentage of volume usage														
Volume Size	The size of the volume														
Disk Error	Disk I/O status														
	<table border="1"> <thead> <tr> <th>Status</th> <th>Description</th> </tr> </thead> <tbody> <tr> <td>NO ERROR</td> <td>Normal</td> </tr> <tr> <td>ERROR</td> <td>Abnormal (Unable to I/O)</td> </tr> <tr> <td>--</td> <td>Unknown</td> </tr> </tbody> </table>	Status	Description	NO ERROR	Normal	ERROR	Abnormal (Unable to I/O)	--	Unknown						
	Status	Description													
	NO ERROR	Normal													
	ERROR	Abnormal (Unable to I/O)													
--	Unknown														
DP Error	Whether or not there is data partition I/O error in servers														

Item Name	Description
CP Error	Whether or not there is cluster partition I/O error in servers

- When the hybrid disk resource status is Recovering

```

Status:                Recovering

hd01                   svg01                   svg02
-----
-----
Mirror Color           YELLOW           ->           YELLOW
                        40%

Recovery Status
-----
-----
Source Server          server1
Destination Server     server3
Used Time              00:00:28
Remain Time            00:00:14
    
```

Description on each item

Item Name	Description
Mirror Status	Hybrid disk resource status *1
Mirror Color	Hybrid disk status in servers *1
	Copy direction of mirror recovery is shown with an arrow. -> : Copy from the left server group to the right server group Or <- : Copy from the right server group to the left server group
	Progress of copying is shown as xx%.
Source Server	Copy source server name
Destination Server	Copy destination server name
Used Time	Time passed since copying started
Remain Time	Estimated time required to complete copying Because it is estimated from the copy rate of the finished part, the value may vary due to load status of the servers or other factors.

*1 See “When the status of mirror disk resource is Normal.”

◆ Hybrid disk resource active status display

When the `-a` or `--active` option is specified, active status of the specified hybrid disk resource is displayed.

```

HD Resource Name:    hd01

Server Name          Active Status          Current Server
-----
svg01
  server1            Active                CURRENT
  server2            Inactive              --
svg02
  server3            Force Active         CURRENT
  server4            Inactive              --
  
```

Server group name

Active status

Active Status	Description
Active	Active
Inactive	Inactive
Force Active	Forced activation
--	Unknown

Current server

Current Server	Description
CURRENT	Current server
--	Non-current server

◆ Hybrid disk resource configuration information display

When the `-l` or `--config` option is specified, configuration information on all hybrid disk resources are displayed.

```

HD Resource Name:    hd01
Syncmode:           Sync

Config              svg01              svg02
-----
Drive Letter        Z:                Z:
Disk Size           1027MB           1027MB
Server Name         server1           server3
                   server2           server4
  
```

Description on each item

Item Name	Description
HD Resource Name	Hybrid disk resource name
Syncmode	Synchronization mode
Drive Letter	Drive letter of the data partition
Disk Size	Data partition size
Server Name	Member server of each server group

◆ Displaying the mirror connect status

When the `-c` or `--connect` option is specified, the mirror connect status is displayed.

An example of a four-node HD is given below.

- [Cluster configuration]
 - Four servers (Server1 - Server4)
 - Two server groups (SvG01 and SvG02)
 - Servers registered for SvG01: Server1 and Server2
 - Servers registered for SvG02: Server3 and Server4
 - One hybrid disk resource (hd01)
- [Cluster status]
 - Hybrid disk resource hd01 is active on Server1.
 - Server group SvG01 is using a priority 1 mirror connect.
 - Server group SvG02 is using a priority 2 mirror connect.

```

Resource Name      : md01
Number of Connection : 2

Mirror Connect    Priority1          Priority2
-----
<SvG01>
Server1
  Address      10.0.10.11      10.0.20.11
  Status      Active        Standby
Server2
  Address      10.0.10.12      10.0.20.12
  Status      Error         Standby

<SvG02>
Server3
  Address      10.0.10.21      10.0.20.21
  Status      Standby        Active
Server2
  Address      10.0.10.22      10.0.20.22
  Status      Standby        Standby
    
```

Explanation of each item

Display item	Description
Resource Name	Hybrid disk resource name
Number of Connection	Number of mirror connects
Address	IP address of the mirror connect (primary and secondary) The values set in the Builder are referenced.

Status	Status of the mirror connect (primary and secondary) (Operation status and presence of any error such as disconnection or connection error)	
	String	Status of mirror connect
	Active	Being used
	Standby	Not used and on standby (There is no error and the connect is available for communication.)
	Error	Not used and disconnected (There is an error and the connect is not available for communication.)
	Unknown	Unknown
	--	No configuration data

Operating hybrid disk resource (clphdctrl command)

clphdctrl: the `clphdctrl` command operates hybrid disk resource.

Command line

```
clphdctrl {-a|--active} hybriddisk-alias [-n or -f]
clphdctrl {-d|--deactive} hybriddisk-alias
clphdctrl {-b|--break} hybriddisk-alias [-n or -f]
clphdctrl {-f|--force} hybriddisk-alias
clphdctrl {-r|--recovery} hybriddisk-alias [-f or -a or -vf] [dest
-servername]
clphdctrl {-c|--cancel} hybriddisk-alias
clphdctrl {-w|--rwait} hybriddisk-alias [-timeout time] [-rcancel]
clphdctrl {-s|--mdcswitch} hybriddisk-alias [priority-number]
clphdctrl {-p|--compress} [hybriddisk-alias]
clphdctrl {-n|--nocompress} [hybriddisk-alias]
```

Note:

Make sure that the EXPRESSCLUSTER service has been stopped when you use the `--active` or `--deactive` option.

Description	Activates/deactivates hybrid disk resource and recovers mirror.	
Option	<code>-a, --active</code>	Activates hybrid disk resource on the local server. If the status of hybrid disk resource is normal, mirroring is performed. If the status of hybrid disk resource is not normal, mirroring will not be performed.
	<code>-n</code>	Specifies normal activation for activation mode. This option can be omitted. This cannot be specified when <code>-f</code> is specified.
	<code>-f</code>	Specifies forced activation for activation mode. This option can be omitted. This cannot be specified when <code>-n</code> is specified.
	<code>-d, --deactive</code>	Deactivates the activated hybrid disk resource on the local server.
	<code>-b, --break</code>	Stops mirroring of the hybrid disk resource and makes the data status not to be the latest on the server where the command is executed. The data is not synchronized until mirror recovery is completed even if writing on the hybrid disk takes place. Specify the <code>-f</code> or <code>-n</code> option.

-n	Specifies the degeneration mode as normal degeneration. In the case of normal degeneration, mirroring is intermitted and the server becomes not the latest status only when the mirroring is executed normally on the hybrid disk. This cannot be specified when -f is specified.
-f	Specifies the degeneration mode as forced degeneration mode. In the case of forced degeneration, mirroring is intermitted and the server becomes not the latest status even if the mirroring target server/server group status is abnormal or unknown. This cannot be specified when -n is specified.
-f,--force	Performs forced mirror recovery on the specified hybrid disk resource.
-r,--recovery	Performs either full mirror recovery or differential mirror recovery for the specified hybrid disk resource with the local server as copy source.
-f	Copies all the used area of a volume if the used area can be identified. Copies the entire area of a volume if the used area cannot be identified. This cannot be specified when -a or -vf is specified.
-a	Automatically selects the recovery mode. If the difference can be identified, differential copying is performed. If differences cannot be identified, the command behaves in the same way as when -f is specified. This cannot be specified when -f or -vf is specified.
-vf	Copies the entire area of a volume regardless of differences and the used area.
-c,--cancel	Cancels mirror recovery.
-w,--rwait	Waits for the completion of the specified disk resource mirror recovery.
-timeout <i>time</i>	Specifies the time of mirror recovery completion timeout (second). This option can be omitted. When this option is omitted, timeout is not executed and waits for the completion of mirror recovery.
-rcancel	Intermits mirror recovery when waiting for the mirror recovery completion is timed out. This option can be set when -timeout option is set. When this option is omitted, the mirror recovery continues even after the timeout takes place.

	<code>-s,--mdcswitch</code>	<p>Switches between the primary and secondary mirror disk connects of the user-specified disk resource.</p> <p>If the priority number is omitted, the secondary mirror disk connect is switched to when the primary mirror disk connect is used at the time of command execution. When the secondary mirror disk connect is used, the primary mirror disk connect is switched to.</p> <p>If the priority numbers are specified, the mirror disk connect that has the appropriate priority number is switched to.</p>
	<code>-p,--compress</code>	<p>Temporarily enables mirror data compression for the specified disk resource.</p> <p>If the hybrid disk resource name is omitted, mirror data compression is temporarily enabled for all hybrid disk resources.</p>
	<code>-n,--nocompress</code>	<p>Temporarily disables mirror data compression for the specified disk resource.</p> <p>If the hybrid disk resource name is omitted, mirror data compression is temporarily disabled for all hybrid disk resources.</p>
Parameter	<code>hybriddisk-alias</code>	Specifies the hybrid disk resource name.
	<code>dest-servername</code>	Specifies the copy destination server name. When you omit this, the copy destination server is automatically determined from another server group.
	<code>priority-number</code>	Specify the number 1 or 2.
Return Value	0	Success
	Other than 0	Failure
	101	Invalid parameter
	102	Invalid status including the case when <code>-w</code> or <code>--rwait</code> option is specified and mirror recovery is intermitted by <code>-rcancel</code> .
	103	Operations for the same resource are executed simultaneously from other servers.
	104	Operations for the same resource were executed simultaneously from the own server.
	106	The server that command is executed does not have the target resource.
	107	I/O error occurred on the cluster partition or on the data partition.
	109	Waiting for the completion of Mirror recovery of the target hybrid disk is timed out (only when <code>-w</code> or <code>--rwait -timeout</code> option is specified).

110	Other errors
201	The status of the destination mirror disk connect is invalid (only when the <code>-m</code> or <code>--mdcswitch</code> option is specified).
202	Only one mirror disk connect is set up (only when the <code>-m</code> or <code>--mdcswitch</code> option is specified).
203	All the servers in the remote server group are down (only when the <code>-m</code> or <code>--mdcswitch</code> option is specified).

Remarks This command returns control when the specified processing starts. Run the `clpmdstat` command to check the processing status.

Notes This command must be executed by the user with administrator privilege.

When performing mirror recovery again after mirror recovery failed, specify the same server you used last time for mirror recovery or another server in the same server group which this server belongs to as a copy source.

To resume mirror recovery that was suspended by selecting **Cancel**, use this command for forced mirror recovery.

Example of command execution

Example 1: When activating hybrid disk resource `hd1`

```
# clphdctrl --active hd1
Command succeeded.
```

Example 2: When deactivating hybrid disk resource `hd1`

```
# clphdctrl --deactive hd1
Command succeeded.
```

Example 3: When recovering mirror for hybrid disk resource `hd1`

```
# clphdctrl --recovery hd1
Command succeeded.
```

Error Message

Message	Cause/Solution
Invalid parameter.	The parameter is invalid. Check if there is any error in its format or parameter.
The status of <code>[HD_resource_name]</code> is invalid.	Check the status and execute the command again.
This command is already run in another server.	After finishing the command which is currently executed, execute the command again.
This command is already run in the local server.	After finishing the command which is currently executed, execute the command again.
<code>[copy_destination_server_name]</code> is down.	Start the server which has been specified as copy destination, or specify another server as copy destination to execute the command again.
<code>[local_server_name]</code> is not included in Servers that can run the Group of <code>[HD_resource_name]</code> .	Execute the command from the server where the target HD resource can be started.

Message	Cause/Solution
Disk error.	Check if there is not HW failure in the disk or disk path where cluster partition or data partition exists.
Mirror recovery of <i>[HD resource name]</i> is timed out.	Check if the specified timeout time is appropriate, or if the disk I/O or communication delay is not occurring due to heavy load.
Internal error. <i>[error_code]</i>	Restart the local server.
The status of the destination mirror connect is invalid.	Check the connection status of the mirror disk connect.
There is only one mirror connect that is set for <i>[HD resource name]</i> .	Make sure that more than one mirror disk connect is registered.
All the servers of the remote server group are out of service.	Check the server operating status.

Outputting messages (clplogcmd command)

clplogcmd: the `clplogcmd` command registers the specified text into alert.

Command line:

```
clplogcmd -m message [--alert] [-i ID] [-l level]
```

Note:

Generally, it is not necessary to run this command for constructing or operating the cluster. You need to write the command in the script resource script.

Description	Write this command in the script resource script and output messages you want to send to the destination. Messages are produced in the following format: [ID] message
Options	<p><code>-m <i>message</i></code> Specifies text to be produced in message. This option cannot be omitted. The maximum size of message is 498 bytes. You may use alphabets, numbers, and symbols. See below (*) for notes on them.</p> <p><code>--alert</code> This parameter can be omitted. You can specify only alert as the output destination of this command. For more information on output destinations, see "Directory structure of EXPRESSCLUSTER" in Chapter 10, "The system maintenance information" in this guide.</p> <p><code>-i <i>ID</i></code> Specify event ID. This parameter can be omitted. The default value 1 is set for the event ID when the parameter is omitted.</p> <p><code>-l <i>level</i></code> Select a level of alert output from ERR, WARN, or INFO. The icon on the alert view of the WebManager is determined according to the level you select here. This parameter can be omitted. The default value INFO is set to level when the parameter is omitted. See "Checking alerts using the WebManager" on page 80 for more information.</p>
Return Value	<p>0 Success</p> <p>Other than 0 Failure</p>
Notes	Run this command as a user with Administrator privileges. The specification of the <code>-i</code> option is different from that of the Linux version. The event ID that is displayed in alert is fixed and unchangeable in the Windows version

Example of command execution

Example 1: When specifying only message

When the following is written in the script resource script, text is produced in alert.

```
clplogcmd -m test1
```

The following is displayed in the alert view of the WebManager:

	Receive Time	Time ▾	Server Name	Module Name	Event ID	Message
	2004/09/01 14:00:00	2004/09/01 14:00:00	server1	logcmd	1	test1

Example 2: When specifying message, message ID, and level:

When the following is written in the script resource script, the text is produced in alert.

```
clplogcmd -m test2 -i 100 -l ERR
```

The following alert is displayed on the alert view of the WebManager:

	Receive Time	Time ▾	Server Name	Module Name	Event ID	Message
	2004/09/01 14:00:00	2004/09/01 14:00:00	server1	logcmd	3601	[100] test2

*** Notes on using symbols in text:**

The symbols below must be enclosed in double quotes (“ ”):

& | < >

(For example, if you specify “&” in the message, & is produced.)

The symbols below must have a backslash \ in the beginning:

\

(For example, if you specify \\ in the message, \ is produced.)

When there is a space in text, it must be placed in enclosed in double quotes (“ ”).

The symbol % cannot be used in text.

Controlling monitor resources (clpmonctrl command)

clpmonctrl: the `clpmonctrl` command controls the monitor resources.

Command line:

```
clpmonctrl -s [-m resource name ...] [-w wait time]
clpmonctrl -r [-m resource name ...] [-w wait time]
clpmonctrl -c [-m resource name ...]
clpmonctrl -v [-m resource name ...]
clpmonctrl -e -m resource name
clpmonctrl -n [-m resource name]
```

Note:

This command must be run on all servers that control monitoring because the command controls the monitor resources on a single server.

When the `-c` and `--clear` options are applied only to several servers, the number of recovery operation count may be inconsistent among the servers and the recovery operations may fail.

Description	This command suspends and/or resumes the monitor resources, displays and/or initializes the recovery operation count, and enable and/or disable dummy failure on a single server.	
Option	<code>-s,</code> <code>--suspend</code>	Suspends monitoring
	<code>-r,</code> <code>--resume</code>	Resumes monitoring
	<code>-c,</code> <code>--clear</code>	Initializes the recovery operation count.
	<code>-v, --view</code>	Displays the recovery operation count.
	<code>-e</code>	Enables dummy failure. Be sure to specify a monitor resource name with the <code>-m</code> option.
	<code>-n</code>	Disables dummy failure. When a monitor resource name is specified with the <code>-m</code> option, the function is disabled only for the resource. When the <code>-m</code> option is omitted, the function is disabled for all monitor resources.
	<code>-m,</code> <code>--monitor</code>	Specifies one or more monitor resources to be controlled. This option can be omitted. All monitor resources are controlled when the option is omitted.
	<code>-w, --wait</code>	Waits for control monitoring on a monitor resource basis (in seconds). This option can be omitted. The default value of 5 is set when the option is omitted.

Return Value	0	Normal termination
	1	Privilege for execution is invalid
	2	The option is invalid
	3	Initialization error
	4	The cluster configuration data is invalid
	5	Monitor resource is not registered.
	6	The specified monitor resource is invalid
	10	The cluster is not activated
	11	The EXPRESSCLUSTER service is suspended
	12	Waiting for cluster synchronization
	90	Monitoring control wait time-out
	128	Duplicated activation
	255	Other internal error

Example of command execution

Monitor resource configuration

```
# clpstat -m
=== MONITOR RESOURCE STATUS ===
Cluster : cluster
  *server0 : server1
  server1 : server2

Monitor0 [ipwl : Normal]
-----
server0 [o] : Online
server1 [o] : Online

Monitor1 [miiw1: Normal]
-----
server0 [o] : Online
server1 [o] : Online

Monitor2 [userw : Normal]
-----
server0 [o] : Online
server1 [o] : Online
=====
```

In the examples 1 through 4 below, the monitor resources of the server1 are controlled.

To control the monitor resources of the server2, run this command in the server2.

Example 1: When suspending all monitor resources:

```
# clpmonctrl -s
Command succeeded.
# clpstat -m
=== MONITOR RESOURCE STATUS ===
Cluster : cluster
  *server0 : server1
  server1 : server2
```

```

Monitor0 [ipw1 : Caution]
-----
server0 [o] : Suspend
server1 [o] : Online

Monitor1 [miiw1: Caution]
-----
server0 [o] : Suspend
server1 [o] : Online

Monitor2 [userw : Caution]
-----
server0 [o] : Suspend
server1 [o] : Online
=====

```

Example 2: When resuming all monitor resources:

```

# clpmonctrl -r
Command succeeded.
# clpstat -m
=== MONITOR RESOURCE STATUS ===
Cluster : cluster
 *server0 : server1
  server1 : server2

Monitor0 [ipw1 : Normal]
-----
server0 [o] : Online
server1 [o] : Online

Monitor1 [miiw1 : Normal]
-----
server0 [o] : Online
server1 [o] : Online

Monitor2 [userw : Normal]
-----
server0 [o] : Online
server1 [o] : Online
=====

```

Example 3: When displaying recovery operation count for all monitor resources:

```

# clpmonctrl -v

Resource : miiw1
Script Count : 0/0
Restart Count : 1/1
Failover Count : 3/3
FinalAction Count : 0 [No Operation]

Resource : miiw1
Script Count : 0/0
Restart Count : 0/0
Failover Count : 1/1

```

```

FinalAction Count : 0[No Operation]
-----
Resource          : servicew1
Script Count      : 0/0
Restart Count     : 0/0
Failover Count    : 1/2
FinalAction Count : 0[No Operation]
-----
Command succeeded.

```

Example 4: When initializing recovery operation count for all monitor resources:

```

C:\Users\Administrator>clpmonctrl -c
Command succeeded.

C:\Users\Administrator>clpmonctrl -v
-----
Resource          : fipw1
Script Count      : 0/0
Restart Count     : 0/3
Failover Count    : 0/2
FinalAction Count : 0[No Operation]
-----

Resource          : ossw
Script Count      : 0/0
Restart Count     : 0/0
Failover Count    : 0/2
FinalAction Count : 0[No Operation]
-----

Resource          : servicew_ControlManager
Script Count      : 0/0
Restart Count     : 0/0
Failover Count    : 0/2
FinalAction Count : 0[No Operation]
-----
Command succeeded.

```

Example 5: When suspending only the IP monitor resource (ipw1):

```

# clpmonctrl -s -m ipw1
Command succeeded.
# clpstat -m
=== MONITOR RESOURCE STATUS ===
Cluster : cluster
  *server0 : server1
  server1  : server2

Monitor0 [ipw1 : Caution]
-----
server0 [o] : Suspend
server1 [o] : Online
-----
Monitor1 [miw1: Normal]
-----
server0 [o] : Online
server1 [o] : Online
-----
Monitor2 [userw : Normal]

```

```
-----
server0 [o] : Online
server1 [o] : Online
=====
```

Example 6: When resuming only the IP monitor resource (ipw1):

```
# clpmonctrl -r -m ipw1
Command succeeded.
# clpstat -m

=== MONITOR RESOURCE STATUS ===
Cluster : cluster
 *server0 : server1
  server1 : server2
  Monitor0 [ipw1 : Normal]

-----

server0 [o] : Online
server1 [o] : Online

Monitor1 [miiw1: Normal]

-----

server0 [o] : Online
server1 [o] : Online

Monitor2 [userw : Normal]

-----

server0 [o] : Online
server1 [o] : Online
=====
```

Example 7: When displaying recovery operation count for IP monitor resources:

```
C:\>clpmonctrl -v -m ipw1

-----

Resource ----- : ipw1
Script Count      : 0/0
Restart Count     : 3/3
Failover Count    : 2/2
FinalAction Count : 0[No Operation]

Command succeeded.
```

Example 8: When initializing recovery operation count for IP monitor resources:

```
C:\>clpmonctrl -v -m ipw1

-----

Resource ----- : ipw1
Script Count      : 0/0
Restart Count     : 0/3
Failover Count    : 0/2
FinalAction Count : 0[No Operation]

Command succeeded.
```

Remarks If you suspend a monitor resource that is already suspended or resume that is already resumed, this command terminates successfully without changing the status of the monitor resource.

Notes Run this command as a user with Administrator privileges.
 Check the status of monitor resource by using the status display command or WebManager.

Before you run this command, use the `clpstat` command or WebManager to verify that the status of monitor resources is in either “Online” or “Suspend.”

In the case of a monitor resource of which monitor timing is “Active”, if a target resource stops temporarily in the active status, and then the target resource or the group which the target resource belongs to is activated, the monitor resource which has been stopped temporarily cannot detect an error. This is because the monitor resource does not start monitoring.

The following are examples of the case described above:

1. Stops an application monitor that is monitoring application resource temporarily.
2. Reactivate the application resource or the group that the application resource belongs to.

This reactivation procedure applies both manual and automatic when a monitor resource detects an error and reactivates an application by the recovery operation.

If you execute `clpmonctrl` command with the `-v` option, “FinalAction Count” is script execution count before final action for following setting.

- The **Execute Script before Final Action** check box is selected.
- **Final Action** is **No operation**.

Error Messages

Message	Causes/Solution
Command succeeded.	The command ran successfully.
You are not authorized to run the command. Log in as Administrator.	You are not authorized to run this command. Log in as a user with Administrator privileges.
Initialization error. Check if memory or OS resources are sufficient.	Check if the memory or OS resource is sufficient.
Invalid cluster configuration data. Check it by using the Builder.	The cluster configuration data is invalid. Check the cluster configuration data by using the Builder.
Monitor resource is not registered.	The monitor resource is not registered.
Specified monitor resource is not registered. Check the cluster configuration information by using the Builder.	The specified monitor resource is not registered. Check the cluster configuration data by using the Builder.
The cluster has been stopped. Check the active status of the cluster service by using the command such as <code>ps</code> command.	The cluster has been stopped. Check the activation status of the EXPRESSCLUSTER service by using the <code>ps</code> command.

Message	Causes/Solution
The cluster has been suspended. The cluster service has been suspended. Check activation status of the cluster service by using a command such as the ps command.	The EXPRESSCLUSTER service has been suspended. Check the activation status of the EXPRESSCLUSTER service by using a command such as ps command.
Waiting for synchronization of the cluster. The cluster is waiting for synchronization. Wait for a while and try again.	Synchronization of the cluster is awaited. Try again after synchronization of the cluster is completed.
Monitor %1 was unregistered, ignored. The specified monitor resources %1 is not registered, but continues processing. Check the cluster configuration data by using the Builder. %1: monitor resource name	There is an unregistered monitor resource in the specified monitor resources, but it is ignored and the process is continued Check the cluster configuration data by using the Builder. %1: Monitor resource name
The command is already executed. Check the execution state by using the "ps" command or some other command.	The command has already been run. Check the status by using the ps command.
Internal error. Check if memory or OS resources are sufficient.	Check if the memory or OS resource is sufficient.

Monitor resource types that can be specified for the -m option

Type	Suspending/Resume	Reset Recovery Count	Dummy Failure Possibility
appliw	y	y	y
diskw	y	y	y
fipw	y	y	y
ipw	y	y	y
mdnw	y	y	n
mdw	y	y	n
miiw	y	y	y
mtw	y	y	y
regsyncw	y	y	y
sdw	y	y	y
servicew	y	y	y
spoolw	n	y	y
vcomw	y	y	y
vipw	n	y	y
cifsw	y	y	y
nasw	y	y	y
hdw	y	y	n
hdtw	y	y	y
genw	y	y	y
vmw	y	y	n
mrw	y	y	n
db2w	y	y	y

Type	Suspending/Resume	Reset Recovery Count	Dummy Failure Possibility
ftpw	y	y	y
httpw	y	y	y
imap4w	y	y	y
odbcw	y	y	y
oraclew	y	y	y
oracleasw	y	y	y
oscw	y	y	y
oss	y	y	y
pop3w	y	y	y
psqlw	y	y	y
smtpw	y	y	y
sqlserverw	y	y	y
tuxw	y	y	y
userw	y	y	y
wasw	y	y	y
wls	y	y	y
otxw	y	y	y
jraw	y	y	y
sraw	y	y	y
psw	y	y	y
ddnsw	n	y	n

Controlling group resources (clprsc command)

clprsc: the `clprsc` command controls group resources

Command line:

```
clprsc -s resource_name [-h hostname] [-f] [--apito timeout]
clprsc -t resource_name [-h hostname] [-f] [--apito timeout]
clprsc -n resource_name
clprsc -v resource_name
```

Description This command starts and stops group resources.

Option	-s	Starts group resources.
	-t	Stops group resources.
	-h	Requests processing to the server specified by the hostname. When this option is skipped, request for processing is made to the following servers. <ul style="list-style-type: none"> • When the group is offline, the command execution server (local server) . • When the group is online, the server where group is activated.
	-f	When the group resource is online, all group resources that the specified group resource depends starts up. When the group resource is offline, all group resources that the specified group resource depends stop.
	-n	Displays the name of the server on which the group resource has been started.
	--apito timeout	Specify the time in seconds to wait for group resources to be started or stopped (internal communication timeout). A value between 1 to 9999 can be specified. When the --apito option is not specified, the command waits according to the value set for the internal communication timeout in the cluster property.
	-v	Displays the failover counter of the group resource.

Return Value	0	success
	Other than 0	failure

Example

Group resource configuration

```
# clpstat
===== CLUSTER STATUS =====
Cluster : cluster
<server>
  *server1 ..... : Online
      lankhb1           : Normal
      lankhb2           : Normal
```

```

    pingnp1                : Normal
server2.....: Online
    lankhb1                : Normal
    lankhb2                : Normal
    pingnp1                : Normal
<group>
    ManagementGroup.....: Online
        current            : server1
    ManagementIP          : Online
    failover1.....: Online
        current            : server1
        fip1               : Online
        md1                : Online
        script1           : Online
    failover2.....: Online
        current            : server2
        fip2               : Online
        md2                : Online
        script1           : Online
<monitor>
    fipw1                  : Normal
    fipw2                  : Normal
    ipw1                   : Normal
    mdnw1                  : Normal
    mdnw2                  : Normal
    mdw1                   : Normal
    mdw2                   : Normal
=====

```

Example 1: When stopping the resource (fip1) of the group (failover 1)

```

# clprsc -t fip1
Command succeeded.
# clpstat
===== CLUSTER STATUS =====
<abbreviation>
<group>
    ManagementGroup ..... : Online
        current            : server1
    ManagementIP          : Online
    failover1 .....: Online
        current            : server1
        fip1               : Offline

```

```

md1 : Online
script1 : Online
failover2..... : Online
current : server2
fip2 : Online
md2 : Online
script1 : Online
<abbreviation>

```

Example 2: When starting the resource (fip1) of the group(failover 1)

```

# clprsc -s fip1
Command succeeded.
#clpstat
===== CLUSTER STATUS =====
<Abbreviation>
<group>
ManagementGroup ..... : Online
current : server1
ManagementIP : Online
failover1 ..... : Online
current : server1
fip1 : Online
md1 : Online
script1 : Online
failover2 ..... : Online
current : server2
fip2 : Online
md2 : Online
script1 : Online
<Abbreviation>

```

Notes

Run this command as a user with Administrator privileges.

Check the status of the group resources by the status display or the WebManager.

When there is an active group resource in the group, the group resources that are offline cannot be started on another server.

Error Messages

Message	Causes/Solution
Log in as Administrator.	Run this command as a user with Administrator privileges.
Invalid cluster configuration data. Check it by using the Builder.	The cluster construction information is not correct. Check the cluster construction information by Builder.

Message	Causes/Solution
Invalid option.	Specify a correct option.
Could not connect server. Check if the cluster service is active.	Check if the EXPRESSCLUSTER is activated.
Invalid server status. Check if the cluster service is active.	Check if the EXPRESSCLUSTER is activated.
Server is not active. Check if the cluster service is active.	Check if the EXPRESSCLUSTER is activated.
Invalid server name. Specify a valid server name in the cluster.	Specify a correct server name in the cluster.
Connection was lost. Check if there is a server where the cluster service is stopped in the cluster.	Check if there is any server with EXPRESSCLUSTER service stopped in the cluster,
Internal communication timeout has occurred in the cluster server. If it occurs frequently, set the longer timeout.	Timeout has occurred in internal communication in the EXPRESSCLUSTER. Set the internal communication timeout longer if this error occurs frequently.
The group resource is busy. Try again later.	Because the group resource is in the process of starting or stopping, wait for a while and try again.
An error occurred on group resource. Check the status of group resource.	Check the group resource status by using the WebManager or the <code>clpstat</code> command.
Could not start the group resource. Try it again after the other server is started, or after the Wait Synchronization time is timed out.	Wait till the other server starts or the wait time times out, then start the group resources.
No operable group resource exists in the server.	Check there is a processable group resource on the specified server.
The group resource has already been started on the local server.	Check the group resource status by using the WebManager or <code>clpstat</code> command.
The group resource has already been started on the other server. To start the group resource on the local server, stop the group resource.	Check the group resource status by using the WebManager or <code>clpstat</code> command. Stop the group to start the group resources on the local server.
The group resource has already been stopped.	Check the group resource status by using the WebManager or <code>clpstat</code> command.
Failed to start group resource. Check the status of group resource.	Check the group resource status by using the WebManager or <code>clpstat</code> command.
Failed to stop resource. Check the status of group resource.	Check the group resource status by using the WebManager or <code>clpstat</code> command.
Depending resource is not offline. Check the status of resource.	Because the status of the depended group resource is not offline, the group resource cannot be stopped. Stop the depended group resource or specify the <code>-f</code> option.
Depending resource is not online. Check the status of resource.	Because the status of the depended group is not online, the group resource cannot be started. Start the depended group resource or specify the <code>-f</code> option.
Invalid group resource name. Specify a valid group resource name in the cluster.	The group resource is not registered.
Server is isolated.	The server is suspended. (Rebooting after down)

Controlling group resources (clprsc command)

Message	Causes/Solution
Internal error. Check if memory or OS resources are sufficient.	Not enough memory space or OS resource. Check if there is enough space.
Server is not in a condition to start resource. Critical monitor error is detected.	Check the status of the server.

Switching off network warning light (clplamp command)

clplamp: The `clplamp` command switches off network warning light .

Command line:

```
clplamp -h host_name
```

Description This command switches off the network warning light corresponding to the specified server.

If the reproduction of audio file is set, audio file reproduction is stopped.

Option `-h` Specify the target server whose network warning light you want to switch off.
 `host_name` This must be configured.

Return value `0` Completed successfully.
 Other than `0` Terminated due to a failure.

Example Example 1: When turning off the warning light and audio alert associated with `server1`

```
# clplamp -h server1  
Command succeeded. (code:0)
```

Notes This command must be executed by a user with the administrator privilege.

Controlling CPU frequency (clpcpufreq command)

clpcpufreq: The `clpcpufreq` command controls CPU frequency.

Command line:

```
clpcpufreq --high [-h hostname]
clpcpufreq --low [-h hostname]
clpcpufreq -i [-h hostname]
clpcpufreq -s [-h hostname]
```

Description	This command enables/disables power-saving mode by CPU frequency control.	
Option	<code>--high</code>	Sets CPU frequency to the highest.
	<code>--low</code>	Sets CPU frequency to the lowest.
	<code>-i</code>	Switch to automatic control by cluster.
	<code>-s</code>	Displays the current CPU frequency level. <code>high</code> : Frequency is the highest <code>low</code> : Frequency is lowered and it is in power-saving mode
	<code>-h</code>	Requests the server specified in <code>hostname</code> for processing. If this is omitted, it requests the local server for processing.
Return Value	0	Completed successfully.
	Other than 0	Terminated due to a failure.
Example	<pre># clpcpufreq -s high Command succeeded. (code:0) # clpcpufreq -- high Command succeeded. (code:0) # clpcpufreq --low -h server1 Command succeeded. (code:0)</pre>	
Remark	If the Use CPU frequency control check box is not selected in the power saving settings in cluster properties, this command results in error.	
Notes	<p>This command must be executed by a user with the administrator privilege.</p> <p>When you use CPU frequency control, it is required that frequency is changeable in the BIOS settings, and that the CPU supports frequency control by Windows OS power management function.</p>	

Error Messages

Message	Cause/Solution
Log in as Administrator.	Log in as a user with Administrator privileges.
This command is already run.	This command has already been run.
Invalid option.	This option is invalid. Check the option.
Invalid mode. Check if --high or --low or -i or -s option is specified.	Check if either of the --high, --low, -I or -s option is specified.
Failed to initialize the xml library. Check if memory or OS resources are sufficient.	Check to see if the memory or OS resource is sufficient.
Failed to change CPU frequency settings.	Check the BIOS settings and the OS settings. Check if the cluster is started. Check if the setting is configured so that CPU frequency control is used.
Failed to acquire CPU frequency settings.	Check the BIOS settings and the OS settings. Check if the cluster is started. Check if the setting is configured so that CPU frequency control is used.
Failed to create the mutex.	Check if the memory or OS resource is sufficient.
Internal error. Check if memory or OS resources are sufficient.	Check if the memory or OS resource is sufficient.

Controlling chassis identify lamp (clpledctrl command)

clpledctrl: The `clpledctrl` command controls the chassis identify function.

Command line:

```
clpledctrl -d [-h hostname] [-a] [-w timeout]
```

```
clpledctrl -i [-h hostname] [-a] [-w timeout]
```

Description This command disables/enables chassis identify function.

Option	-d	Disables the chassis identify function.
	-i	Enables the chassis identify function.
	-h <i>hostname</i>	Specifies the name of the server which enables/disables the chassis identify function. Specify -a to omit this.
	-a	All servers in the cluster are the targets. The -a option can be omitted. If so, specify -h <i>hostname</i> .
	-w <i>timeout</i>	Specifies the timeout value of the command by the second. If the -w option is not specified, it waits for 30 seconds.

Return Value	0	Completed successfully.
	Other than 0	Terminated due to a failure.

Notes This command must be executed by a user with the administrator privilege. Execute this command in the server operating normally in the same cluster as the one which the target server belongs to.

If you disable the chassis identify function by this command, it is canceled when the cluster is restarted or when the target server recovers the normal status.

Examples

Example 1: When disabling (i.e. turn off the lamp which is turned on) the chassis identify function in server1 (specify the command timeout as 60 seconds)

```
# clpledctrl -d -h server1 -w 60
```

Example 2: When disabling chassis identify in all servers in the cluster

```
# clpledctrl -d -a
```

Example 3: When enabling the chassis identify function in server1 where the function was disabled

```
# clpledctrl -i -h server1
```

The result of command execution is displayed as follows:
 Detail of the processing Server name: Result (Cause if failed)

Error messages

Message	Cause/solution
Log in as Administrator.	Log in as a user with Administrator privileges.
Invalid option.	The command line option is invalid. Specify the correct option.
Internal error. Check if memory or OS resources are sufficient.	Check if the memory or OS resource is sufficient.
Could not connect to all data transfer server. Check if the server has started up.	Could not connect to all the IP addresses specified. Check the IP addresses and the status of the target server.
Could not connect to the data transfer server. Check if the server has started up.	Could not connect to all the IP addresses specified. Check the IP addresses and the status of the target server.
Command timeout	The cause may be heavy load on OS and so on. Check this.
Chassis identify is not setting or active at all server.	Chassis identify is disabled or not used.
All servers are busy. Check if this command is already run.	This command may be run already. Check it.
Failed to obtain the list of nodes. Specify a valid server name in the cluster.	Specify a valid server name in the cluster.

Processing inter-cluster linkage (clptrnreq command)

clptrnreq: The `clptrnreq` command requests a server to execute a process.

Command line:

```
clptrnreq -t request_code -h IP [-r resource_name] [-s script_file]
[-w timeout]
```

Description The command issues the request to execute specified process to the server in another cluster.

Option	<p><code>-t</code> <i>request_code</i></p> <p><code>-h</code> <i>IP</i></p> <p><code>-r</code> <i>resource_name</i></p> <p><code>-s</code> <i>script_file</i></p> <p><code>-w</code> <i>timeout</i></p>	<p>Specifies the request code of the process to be executed. The following request codes can be specified:</p> <table border="0"> <tr> <td>GRP_FAILOVER</td> <td>Group failover</td> </tr> <tr> <td>EXEC_SCRIPT</td> <td>Execute script</td> </tr> </table> <p>Specifies the server to issue the request to execute the process with IP address. You can specify more than one server by separating by commas. The maximum number of IP addresses you can specify is 32.</p> <p>When you specify group failover for request code, specify the IP addresses of all the servers in the cluster.</p> <p>Specifies the resource name which belongs to the target group for the request for process when GRP_FAILOVER is specified for request code.</p> <p>If GRP_FAILOVER is specified, <code>-r</code> cannot be omitted.</p> <p>Specifies the file name (within 30 characters) of the script to be executed (e.g. batch file or executable file) when EXEC_SCRIPT is specified for request code. The script needs to be created in the work\trnreq folder in the folder where EXPRESSCLUSTER is installed in each server specified with <code>-h</code>.</p> <p>If EXEC_SCRIPT is specified, <code>-s</code> cannot be omitted.</p> <p>Specifies the timeout value of the command by the second. The minimum value is 5 seconds.</p> <p>If the <code>-w</code> option is not specified, it waits for 30 seconds.</p>	GRP_FAILOVER	Group failover	EXEC_SCRIPT	Execute script
GRP_FAILOVER	Group failover					
EXEC_SCRIPT	Execute script					

Return Value	<p>0 Completed successfully.</p> <p>Other than 0 Terminated due to a failure.</p>
---------------------	---

- Notes** This command must be executed by a user with the administrator privilege.
- It is required that EXPRESSCLUSTER for Windows of internal version 10.02 or later, or EXPRESSCLUSTER for Linux of internal version 2.0.2_1 or later is set up in the server which executes this command and the server with the IP address specified by -h.
- Examples**
- Example 1: When performing a failover on the group having the appli1 resource of another cluster
- ```
clptrnreq -t GRP_FAILOVER -h 10.0.0.1,10.0.0.2 -r appli1
```
- GRP\_FAILOVER 10.0.0.1: Success
- GRP\_FAILOVER 10.0.0.2: Group that specified resource (appli1) belongs is offline.
- Example 2: When executing the scrpit1.bat script by the server with IP address 10.0.0.1
- ```
# clptrnreq -t EXEC_SCRIPT -h 10.0.0.1 -s script1.bat
```
- EXEC_SCRIPT 10.0.0.1: Success

Error messages

Message	Cause/solution
Log in as Administrator.	Log in as a user with Administrator privileges.
Invalid option.	The command line option is invalid. Specify the correct option.
All servers are busy. Check if this command is already run.	This command may be run already. Check it.
Internal error. Check if memory or OS resources are sufficient.	Check if the memory or OS resource is sufficient.
Command timeout	The cause may be heavy load on OS and so on. Check this.
Failed to obtain the list of nodes. Specify a valid server name in the cluster.	Failed to obtain the list of nodes. Specify a valid IP address.
Could not connect to all data transfer server. Check if the server has started up.	Could not connect to all IP addresses specified. Check the IP addresses and the status of the target server.
Could not connect to the data transfer server. Check if the server has started up.	Could not connect to the IP address specified. Check the IP address and the status of the target server.
GRP_FAILOVER <i>IP</i> : Group that specified resource (<i>resource_name</i>) belongs to is offline.	Failover process is not performed because the group to which the specified resource belongs is not started on the target server.
EXEC_SCRIPT <i>IP</i> : Specified script (<i>script_file</i>) does not exist.	The script does not exist on the specified server. Check it.
EXEC_SCRIPT <i>IP</i> : Specified script (<i>script_file</i>) is not executable.	The specified script could not be executed. Check that execution is permitted.
<i>request_code IP</i> : This server is not permitted to execute clptnreq.	The server that executed the command does not have permission. Check that the server is registered to the connection restriction IP list of WebManager.
<i>request_code IP</i> : REQUEST_TYPE failed in execute.	The execution processing of the request type failed. (Either of a present request type Failover or Script is specified.)

Requesting processing to cluster servers (clprexec command)

clprexec: The `clprexec` command requests a server to execute a process.

Command line:

```
clprexec --failover [group_name] -h IP [-r resource_name] [-w timeout]
        [-p port_number] [-o logfile_path]
```

```
clprexec --script script_file -h IP [-p port_number] [-w timeout] [-o
logfile_path]
```

```
clprexec --notice [mrw_name] -h IP [-k category [.keyword]] [-p
        port_number] [-w timeout] [-o logfile_path]
```

```
clprexec --clear [mrw_name] -h IP [-k category [.keyword]] [-p
        port_number] [-w timeout] [-o logfile_path]
```

Description This command is an expansion of the existing `clptrnreq` command and has additional functions such as issuing a processing request (error message) from the external monitor to the EXPRESSCLUSTER server.

Option	<code>--failover</code>	<p>Requests group failover. Specify a group name for <i>group_name</i>.</p> <p>When not specifying the group name, specify the name of a resource that belongs to the group by using the <code>-r</code> option.</p>
	<code>--script</code> <i>script_name</i>	<p>Requests script execution.</p> <p>For <i>script_name</i>, specify the file name of the script to execute (such as a batch file or executable file).</p> <p>The script must be created in the <code>work/trnreq</code> folder, which is in the folder where EXPRESSCLUSTER is installed, on each server specified using <code>-h</code>.</p>
	<code>--notice</code>	<p>Sends an error message to the EXPRESSCLUSTER server.</p> <p>Specify a message reception monitor resource name for <i>mrw_name</i>.</p> <p>When not specifying the monitor resource name, specify the monitor type and monitor target of the message reception monitor resource by using the <code>-k</code> option.</p>
	<code>--clear</code>	<p>Requests changing the status of the message reception monitor resource from “Abnormal” to “Normal.”</p> <p>Specify a message reception monitor resource name for <i>mrw_name</i>.</p> <p>When not specifying the monitor resource name, specify the monitor type and monitor target of the message reception monitor resource by using the <code>-k</code> option.</p>

- h** *IP Address* Specify the IP addresses of EXPRESSCLUSTER servers that receive the processing request.
Up to 32 IP addresses can be specified by separating them with commas.
* If this option is omitted, the processing request is issued to the local server.
- r** *resource_name* Specify the name of a resource that belongs to the target group for the processing request when the `--failover` option is specified.
- k** *category[.key word]* For *category*, specify the category specified for the message receive monitor when the `--notice` or `--clear` option is specified.
To specify the keyword of the message receive monitor resource, specify them by separating them with period after *category*.
- p** *port_number* Specify the port number.
For *port_number*, specify the data transfer port number specified for the server that receives the processing request.
The default value, 29002, is used if this option is omitted.
- o** *logfile_path* For *logfile_path*, specify the file path along which the detailed log of this command is output.
The file contains the log of one command execution.
* If this option is not specified on a server where EXPRESSCLUSTER is not installed, the log is always output to the standard output.
- w** *timeout* Specify the command timeout time. The default, 180 seconds, is used if this option is not specified.
A value from 5 to 999 can be specified.

Return Value	0	Completed successfully.
	Other than 0	Terminated due to a failure.

Notes When issuing error messages by using the `clprexec` command, the message reception monitor resources for which executing an action when an error occurs is specified in EXPRESSCLUSTER server must be registered and started.

The command version is output to the standard output when the command is executed.

The command checks whether the character string specified for the `--script` option includes “\”, “/” or “..” because a relative path must not be specified.

The server that has the IP address specified for the `-h` option must satisfy the following conditions:

- = EXPRESSCLUSTER X 3.0 or later must be installed.
- = EXPRESSCLUSTER must be running.

= mrw must be set up and running.

When [Limiting the access by using client IP addresses] is enabled, add the IP address of the device to execute the [clprexec] command.

For details of [Limiting the access by using client IP addresses], refer to “Chapter 1 Functions of the WebManager Setting limitations on the connection and operation of the WebManager Type of limitation“ of this guide.

Examples

Example 1: This example shows how to issue a request to fail over the group failover1 to EXPRESSCLUSTER server 1 (10.0.0.1):

```
# clprexec --failover failover1 -h 10.0.0.1 -p 29002
```

Example 2: This example shows how to issue a request to fail over the group to which the group resource (exec1) belongs to EXPRESSCLUSTER server 1 (10.0.0.1):

```
# clprexec --failover -r exec1 -h 10.0.0.1
```

Example 3: This example shows how to issue a request to execute the script (script1.bat) on EXPRESSCLUSTER server 1 (10.0.0.1):

```
# clprexec --script script1.bat -h 10.0.0.1
```

Example 4: This example shows how to issue an error message to EXPRESSCLUSTER server 1 (10.0.0.1):

```
* mrw1 set, category: earthquake, keyword: scale3
```

- This example shows how to specify a message reception monitor resource name:

```
# clprexec --notice mrw1 -h 10.0.0.1 -w 30 -o /tmp/clprexec/ clprexec.log
```

- This example shows how to specify the *category* and *keyword* specified for the message reception monitor resource:

```
# clprexec --notice -h 10.0.0.1 -k earthquake.scale3 -w 30 -o /tmp/clprexec/clprexec.log
```

Example 5: This example shows how to issue a request to change the monitor status of mrw1 to EXPRESSCLUSTER server 1 (10.0.0.1):

```
* mrw1 set, category: earthquake, keyword: scale3
```

- This example shows how to specify a message reception monitor resource name:

```
# clprexec --clear mrw1 -h 10.0.0.1
```

- This example shows how to specify the *category* and *keyword* specified for the message reception monitor resource:

```
# clprexec --clear -h 10.0.0.1 -k earthquake.scale3
```

Error messages

Message	Cause/solution
Success	-
Invalid option.	Check the command argument.
Could not connect to the data transfer servers. Check if the servers have started up.	Check whether the specified IP address is correct and whether the server that has the IP address is running.
Could not connect to all data transfer server.	Check whether the specified IP address is correct and whether the server that has the IP address is running.
Command timeout.	Check whether the processing is complete on the server that has the specified IP address.
All servers are busy. Check if this command is already run.	This command might already be running.
Group(%s) is offline.	Check the processing result on the server that received the request.
Group that specified resource(%s) belongs to is offline.	Check the group status.
Specified script(%s) does not exist.	Check if the specified script exist.
Specified resource(%s) is not exist.	Check the resource name or monitor resource name.
Specified resource(Category:%s, Keyword:%s) is not exist.	Check the resource name or monitor resource name.
Specified group(%s) does not exist.	Check the group name.
This server is not permitted to execute clprexec.	Check whether the IP address of the server that executes the command is registered in the list of client IP addresses that are not allowed to connect to the WebManager.
%s failed in execute.	Check the status of the EXPRESSCLUSTER server that received the request.

Changing BMC information (clpbmccnf command)

clpbmccnf: The `clpbmccnf` command changes the information on BMC user name and password.

Command line:

```
clpbmccnf [-u username] [-p password]
```

Description	This command changes the user name/password for the LAN access of the baseboard management controller (BMC) which EXPRESSCLUSTER uses for chassis identify or forced stop.	
Option	<code>-u <i>username</i></code>	Specifies the user name for BMC LAN access used by EXPRESSCLUSTER. A user name with Administrator privilege needs to be specified. The <code>-u</code> option can be omitted. Upon omission, when the <code>-p</code> option is specified, the value currently set for user name is used. If there is no option specified, it is configured interactively.
	<code>-p <i>password</i></code>	Specifies the password for BMC LAN access used by EXPRESSCLUSTER. The <code>-p</code> option can be omitted. Upon omission, when the <code>-u</code> option is specified, the value currently set for password is used. If there is no option specified, it is configured interactively.
Return Value	0	Completed successfully.
	Other than 0	Terminated due to a failure.
Notes	<p>This command must be executed by a user with the administrator privilege.</p> <p>Execute this command when the cluster is in normal status.</p> <p>BMC information update by this command is enabled when the cluster is started/resumed next time.</p> <p>This command does not change the BMC settings. Use a tool attached with the server or other tools in conformity with IPMI standard to check or change the BMC account settings.</p>	
Examples	<p>When you changed the IPMI account password of the BMC in server1 to mypassword, execute the following on server1:</p> <pre># clpbmccnf -p mypassword</pre> <p>Alternatively, enter the data interactively as follows:</p> <pre># clpbmccnf New user name: <- If there is no change, press Return to skip New password: ***** Retype new password: ***** Cluster configuration updated successfully.</pre>	

Error messages

Message	Cause/solution
Log in as Administrator.	Log in as a user with Administrator privileges.
Invalid option.	The command line option is invalid. Specify the correct option.
Failed to download the cluster configuration data. Check if the cluster status is normal.	Downloading the cluster configuration data has been failed. Check if the cluster status is normal.
Failed to upload the cluster configuration data. Check if the cluster status is normal.	Uploading the cluster configuration data has been failed. Check if the cluster status is normal.
Invalid configuration file. Create valid cluster configuration data by using the Builder.	The cluster configuration data is invalid. Check the cluster configuration data by using the Builder.
<i>tmp_dir</i> already exists. Please delete it and try again.	The folder to store temporary file already exists. Delete the folder and execute the command again.
Can not remove directory: <i>tmp_dir</i> .	Deleting the folder to store temporary file failed. Delete the folder separately.
Internal error. Check if memory or OS resources are sufficient.	Check if the memory or OS resource is sufficient.

Configuring shutdown hook (clphookctrl command)

clphookctrl: The `clphookctrl` command configures the shutdown hook function.

Command line:

```
clphookctrl -s [-m mode]
```

```
clphookctrl -m mode
```

```
clphookctrl -t
```

Description This command configures the function which hooks the OS shutdown process to execute node shutdown or restart of EXPRESSCLUSTER. By using this function, OS shutdown or restart can be performed after successfully terminating or moving the operating failover group when OS shutdown is performed by other than EXPRESSCLUSTER.

Option	<code>-s</code>	Enables the shutdown hook function.
	<code>-t</code>	Disables the shutdown hook function.
	<code>-m mode</code>	Configures the process to be executed after the OS shutdown hook. Specify either of the following for mode:
		SHUTDOWN Server shutdown (preset value)
		REBOOT Server restart

Return Value	0	Completed successfully.
	Other than 0	Terminated due to a failure.

Notes This command must be executed by a user with the administrator privilege.

The configuration by the `-s` option is enabled when the EXPRESSCLUSTER Server service is started next time. Configuration by other options are enabled immediately.

Shutdown hook function cannot be used in Windows Server 2008 or later.

Examples If there is a possibility that OS shutdown is executed by the application or middleware other than EXPRESSCLUSTER, you can cancel the OS shutdown to perform EXPRESSCLUSTER server shutdown by executing the following command in each cluster server.

```
# clphookctrl -s
```

Note that in this case although OS restart is executed, it is shut down so that the server is not restarted. Upon restarting the OS, it is required to execute the following command to change the operation settings in advance.

```
# clphookctrl -m REBOOT
```

Error messages

Message	Cause/solution
Invalid option.	The command line option is invalid. Specify the correct option.
Failed to open/edit the registry.	Registry operation has been failed. Check if it is executed with Administrator privilege and EXPRESSCLUSTER is installed correctly.

Controlling cluster activation synchronization wait processing (clpbwctrl command)

clpbwctrl: The `clpbwctrl` command controls the cluster activation synchronization wait processing.

Command line:

```
clpbwctrl -c
```

```
clpbwctrl -h
```

Description This command skips the cluster activation synchronization wait time that occurs if the server is started when the cluster services for all the servers in the cluster are stopped.

Option

<code>-c, --cancel</code>	Cancels the cluster activation synchronization wait processing.
<code>-h, --help</code>	Displays the usage.

Return Value

0	Completed successfully.
Other than 0	Terminated due to a failure.

Notes Run this command as a user with Administrator privileges.

Examples This example shows how to cancel the cluster activation synchronization wait processing:

```
#clpbwctrl -c
Command succeeded.
```

Error messages

Message	Cause/solution
Log in as Administrator	Log in as a user with administrator privileges.
Invalid option.	The command option is invalid. Specify correct option.
Cluster service has already been started.	The cluster has already been started. It is not in startup synchronization waiting status.
The cluster is not waiting for synchronization.	The cluster is not in startup synchronization waiting processing. The cluster service stop or other causes are possible.
Command Timeout.	Command execution timeout.
Internal error.	Internal error occurred.

Controlling reboot count (clpregctrl command)

clpregctrl: the `clpregctrl` command controls reboot count limitation.

Command line:

```
clpregctrl --get
clpregctrl -g
clpregctrl --clear -t type -r registry
clpregctrl -c -t type -r registry
```

Note:

This command must be run on all servers that control the reboot count limitation because the command controls the reboot count limitation on a single server.

Description	This command displays and/or initializes reboot count on a single server	
Option	<code>-g, --get</code>	Displays reboot count information
	<code>-c, --clear</code>	Initializes reboot count
	<code>-t <i>type</i></code>	Specifies the type to initialize the reboot count. The type that can be specified is <i>rc</i> or <i>rm</i> ,
	<code>-r <i>registry</i></code>	Specifies the registry name. The registry name that can be specified is <i>haltcount</i> .
Return Value	0	Completed successfully.
	1	Privilege for execution is invalid
	2	Duplicated activation
	3	Option is invalid
	4	The cluster configuration data is invalid
	10 to 17	Internal error
	20 to 22	Obtaining reboot count information has failed.
	90	Allocating memory has failed.

Examples Display of reboot count information

```
# clpregctrl -g

*****
-----
type      : rc
registry  : haltcount
comment   : halt count
kind      : int
value     : 0
default   : 0
-----
type      : rm
```

```

registry : haltcount
comment : halt count
kind     : int
value    : 3
default  : 0

*****
success.(code:0)
#

```

The reboot count is initialized in the following examples.

Run this command on the server which actually control the reboot count, because the reboot count is recorded on each server.

Example1: When initializing the count of reboots caused by group resource error:

```

# clpregctrl -c -t rc -r haltcount
success.(code:0)
#

```

Example2: When initializing the count of reboots caused by monitor resource error:

```

# clpregctrl -c -t rm -r haltcount
success.(code:0)
#

```

Notes See “What is a group? Reboot count limit” in Chapter 5, “Group resource details” in this guide for information on reboot count limit.

Examples Run this command as a user with Administrator privileges.

Error messages

Message	Cause/solution
Command succeeded.	The command ran successfully.
Log in as Administrator.	You are not authorized to run this command. Run this command as a user with Administrator privileges.
The command is already executed.	The command is already running.
Invalid option.	Specify a valid option.
Internal error. Check if memory or OS resources are sufficient.	Not enough memory space or OS resource.

Estimating the amount of resource usage (clpprer command)

clpprer: Estimates the future value from changes in the resource usage amount written to the input file and outputs the result to a file. It can also be used to check the result of threshold judgment for estimated data.

Command line:

```
clpprer -i inputfile -o outputfile [-p number] [-t number [-1]]
```

Description	Estimates the future value from the tendency of the given resource use amount data.	
Option	-i <i>inputfile</i>	The clpprer command specifies the resource data for which a future value is to be obtained.
	-o <i>outputfile</i>	Specifies the name of the file to which the estimate result is output.
	-p <i>number</i>	Specifies the number of estimate data items. If omitted, 30 items of estimate data are obtained.
	-t <i>number</i>	Specifies the threshold to be compared with the estimate data.
	-1	Valid only when the threshold is set with the -t option. Judges the status to be an error when the data value is less than the threshold.
Return Value	0	Normal end without threshold judgment
	1	Error occurrence
	2	As a result of threshold judgment, the input data is determined to have exceeded the threshold.
	3	As a result of threshold judgment, the estimate data is determined to have exceeded the threshold.
	4	As a result of threshold judgment, the data is determined to have not exceeded the threshold.
	5	If the number of data items to be analyzed is less than the recommended number of data items to be analyzed (120), the input data is determined to have exceeded the threshold as a result of threshold judgment.
	6	If the number of data items to be analyzed is less than the recommended number of data items to be analyzed (120), the estimate data is determined to have exceeded the threshold as a result of threshold judgment.
	7	If the number of data items to be analyzed is less than the recommended number of data items to be analyzed (120), the data is determined to have not exceeded the threshold as a result of threshold judgment.

Notes This command can be used only when the license for the system monitor resource (System Resource Agent) is registered. (If the license is registered, you do not need to configure system monitor resources for the cluster configuration.)

The maximum number of input data items of the resource data file specified with the `-i` option is 500. A certain number of input data items are required to estimate the amount of resource usage. However, if the number of input data items is large, it takes a considerable amount of time to perform the analysis. So, it is recommended that the number of input data items be restricted to about 120. Moreover, the maximum number of output data items that can be specified in option `-p` is 500.

If the time data for the input file is not arranged in ascending order, the estimate will not be appropriate. In the input file, therefore, set the time data arranged in ascending order.

Input file The input file format is explained below. You need to have an input file, written in the following format, for the resource usage amount for which you want to estimate a result.

The input file format is CSV. One piece of data is coded in the form of *date and time, numeric value*.

Moreover, the data and time format is YYYY/MM/DD hh:mm:ss.

File example

```
2012/06/14 10:00:00,10.0
2012/06/14 10:01:00,10.5
2012/06/14 10:02:00,11.0
```

Examples The estimation of the future value is explained using a simple example.

When an error is detected in the input data:

If the latest value of the input data exceeds the threshold, an error is assumed and a return value of 2 is returned. If the number of input data items is less than the recommended value (=120), a return value of 5 is returned.

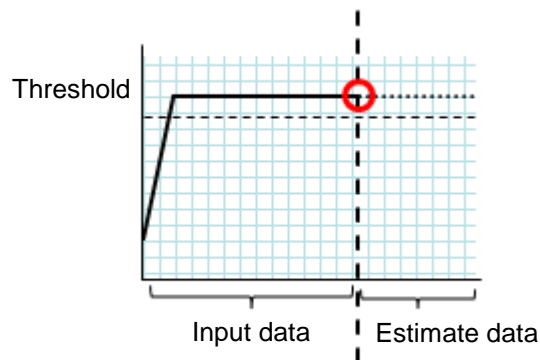

Figure: Error detection in the input data

When an error is detected in the estimate data:

If the estimate data exceeds the threshold, an error is assumed and a return value of 3 is returned. If the number of input data items is less than the recommended value (=120), a return value of 6 is returned.

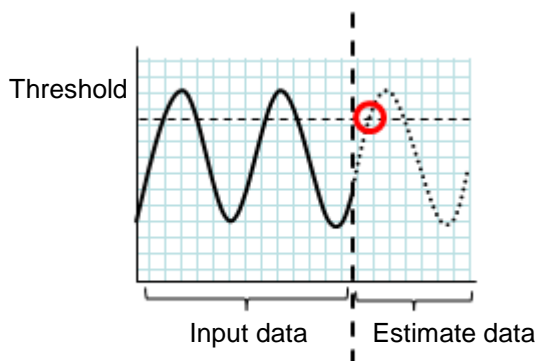

Figure: Error detection in the estimate data

When no threshold error is detected:

If neither the input data nor the estimate data exceeds the threshold, a return value of 4 is returned. If the number of input data items is less than the recommended value (=120), a return value of 7 is returned.

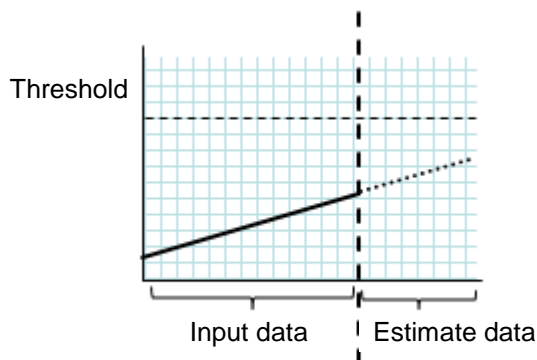

Figure: When no threshold error is detected

When the -l option is used:

If the -l option is used, an error is assumed when the data is less than the threshold.

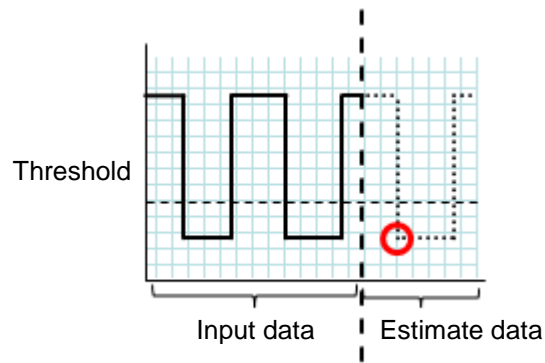

Figure: Use of the -l option

Examples If you use a file written in the specified format and run the clpprer command, you can output the estimate result to a file and check it.

```
Input file test.csv
2012/06/14 10:00:00,10.0
2012/06/14 10:01:00,10.5
2012/06/14 10:02:00,11.0
```

```
# clpprer -i test.csv -o result.csv
```

```
Output result.csv
2012/06/14 10:03:00,11.5
2012/06/14 10:04:00,12.0
2012/06/14 10:05:00,12.5
2012/06/14 10:06:00,13.0
2012/06/14 10:07:00,13.5
:
```

If you set a threshold for option, you can check the result of threshold judgment for estimate data at the command prompt.

```
# clpprer -i test.csv -o result.csv -t 12.5
```

Execution result

```
Detect over threshold. datetime = 2012/06/14
10:06:00, data = 13.00, threshold = 12.5
```

Error messages

Message	Causes/Solution
Normal state.	As a result of threshold judgment, no data exceeding the threshold is detected.

Message	Causes/Solution
Detect over threshold. datetime = %s, data = %s, threshold = %s	As a result of threshold judgment, data exceeding the threshold is detected.
Detect under threshold. datetime = %s, data = %s, threshold = %s	As a result of threshold judgment with the <code>-l</code> option, data less than the threshold is detected.
License is nothing.	The license for the valid System Resource Agent is not registered. Check to see the license.
Inputfile is none.	The specified input data file does not exist.
Inputfile length error.	The path for the specified input data file is too long. Specify no more than 1023 bytes.
Output directory does not exist.	The directory specified with the output file does not exist. Check whether the specified directory exists.
Outputfile length error.	The path for the specified output file is too long. Specify no more than 1023 bytes.
Invalid number of <code>-p</code> .	The value specified in the <code>-p</code> option is invalid.
Invalid number of <code>-t</code> .	The value specified in the <code>-t</code> option is invalid.
Not analyze under threshold(not set <code>-t</code>) .	The <code>-t</code> option is not specified. When using the <code>-l</code> option, also specify the <code>-t</code> option.
File open error [%s]. errno = %s	The file failed to open. The amount of memory or OS resources may be insufficient. Check for any insufficiency.
Inputfile is invalid. cols = %s	The number of input data items is not correct. Set the number of input data items to 2 or more.
Inputfile is invalid. rows = %s	The input data format is incorrect. One line needs to be divided into two rows.
Invalid date format. [expected YYYY/MM/DD HH:MM:SS]	The date of the input data is not of the correct format. Check to see the data.
Invalid date format. Not sorted in ascending order.	Input data is not arranged in ascending order of date and time. Check the data.
File read error.	An invalid value is set in the input data. Check the data.
Too large number of data [%s]. Max number of data is %s.	The number of input data items exceeds the maximum value (500). Reduce the number of data items.
Input number of data is smaller than recommendable number.	The number of input data items is less than the recommended number of data items to be analyzed (120). * Data is analyzed even if the recommended number of data items to be analyzed is small.
Internal error.	An internal error has occurred.

Checking the process health (clphealthchk command)

clphealthchk: Checks the process health.

Command line.

```
clphealthchk [-t pm | -t rc | -t rm | -t nm | -h]
```

Note: This command must be run on the server whose process health is to be checked because this command checks the process health of a single server.

Description This command checks the process health of a single server.

Option	None	Checks the health of all of pm, rc, rm, and nm.
	-t pm	Checks the health of pm.
	-t rc	Checks the health of rc.
	-t rm	Checks the health of rm.
	-t nm	Checks the health of nm.
	-h	Displays the usage.
Return Value	0	Normal termination
	1	Privilege for execution is invalid
	2	Duplicated activation
	3	Initialization error
	4	The option is invalid
	10	The process stall monitoring function has not been enabled.
	11	The cluster is not activated (waiting for the cluster to start or the cluster has been stopped.)
	12	The cluster daemon is suspended
100	There is a process whose health information has not been updated within a certain period. If the -t option is specified, the health information of the specified process is not updated within a certain period.	
255	Other internal error	

Examples **Example 1:** When the processes are healthy

```
# clphealthchk
pm OK
rc OK
rm OK
nm OK
```

Example 2: When clprc is stalled

```
# clphealthchk
pm OK
rc NG
rm OK
nm OK
```

```
# clphealthchk -t rc
rc NG
```

Example 3: When the cluster has been stopped

```
# clphealthchk
The cluster has been stopped
```

Remarks If the cluster has been stopped or suspended, the process is also stopped.

Notes Run this command as a user with Administrator privileges.

Error Messages

Message	Cause/Solution
Log in as Administrator.	Log in as a user with Administrator privileges.
Initialization error. Check if memory or OS resources are sufficient.	Check to see if the memory or OS resource is sufficient.
Invalid option.	Specify a valid option.
The function of process stall monitor is disabled.	The process stall monitoring function has not been enabled.
The cluster has been stopped.	The cluster has been stopped.
The cluster has been suspended.	The cluster has been suspended.
This command is already run.	The command has already been started.
Internal error. Check if memory or OS resources are sufficient.	Check to see if the memory or OS resource is sufficient.

Chapter 4 Compatible command reference

This chapter describes compatible commands.

This chapter covers:

- Compatible command overview 462
- Note on compatible commands 462
- Compatible commands 462
- Displaying the messages on EXPRESSCLUSTER clients (armbroadcast command) 464
- Registering the messages on a log file or an alert log (armlog command) 465
- Starting the applications or services (armload command) 466
- Terminating the application or service (armkill command) 473
- Waiting for the start or stop of groups (armgwait command) 475
- Exclusive control between servers command (armcall command) 476
- Retrieving the cluster wide variable or local variable (armgetcd command) 478
- Setting the cluster wide variable or local variable (armsetcd command) 479
- Monitoring errors on the connection to the shared resources (armwhshr command) 480
- Controlling the applications or services started by the armload command (EXPRESSCLUSTER Task Manager) 483
- Shutting down the server (armdown command) 486
- Moving or failing over a group (armfover command) 487
- Starting a group (armgstrt command) 488
- Stopping a group (armgstop command) 489
- Starting or stopping the application or service, suspending or resuming the monitoring (armloadc command) 490
- Suspending the script execution until the user's direction (armpause command) 492
- Suspending the script execution for the specified time (armsleep command) 493
- Starting the network sharing of the directory (armnsadd command) 494
- Stopping the network sharing of the directory (armnsdel command) 495
- Setting the IP address returned by gethostbyname() (armwsset command) 496
- Setting or displaying the start delay time (armdelay command) 498
- Setting or displaying operations at the occurrence of the emergency shutdown (armem command) 499
- Shutting down the whole cluster (armstdn command) 500
- Returning the server with the status of "Suspension (isolated)" (armmode command) 501
- Permitting an access to the mirror disk (mdopen command) 502
- Prohibiting an access to the mirror disk (mdclose command) 503
- Permitting an access to the shared disk (sdopen command) 504
- Prohibiting an access to the shared disk (sdclose command) 505
- Error messages of the compatible commands 506

Compatible command overview

Compatible commands have compatibility with commands used in EXPRESSCLUSTER Ver8.0 or earlier in functions. This section explains how to use compatible commands.

Note on compatible commands

The following is the note on compatible commands.

- ◆ To use a compatible command, the name of a cluster, server and group needs to be configured according to the naming rules of the conventional version.
- ◆ Compatible commands cannot be used when the server is in the suspension (isolated) status.
- ◆ Run the following compatible commands as a user with Administrator privileges.

Compatible commands

Commands that can be used only in scripts		
command	Description	Page
armbroadcast.exe	Displays a default or optional message on the client on which the EXPRESSCLUSTER client is running.	464
armlog.exe	Registers log messages to the log file.	465
armload.exe	Starts an application. The application started by the armload.exe can be stopped by the armkill.exe in any position of a script.	466
armkill.exe	Stops the application started by the armload.exe.	473
armgwait.exe	Waits for the start or stop of groups	475
armcall.exe	Executes a command specified as a parameter or a program exclusively on nodes.	476
armgetcd.exe	Retrieves the value specified to the desired variable by the armsetcd.exe command. This command can be used for branch conditions of scripts.	478
armsetcd.exe	Sets the value to the desired variable. This value can be referred by the armgetcd.exe command.	479
armwhshr.exe	Monitors errors on the connection to the shared name.	480

Commands that can be used both in and outside scripts.		
command	Description	Page
armaswth.exe	Starts or stops the application or service, or suspends or resumes the monitoring or the application or service that is started by the armload.exe command.	483
armdown.exe	Shuts down a server when you want to fail over a group intentionally, such as when starting or stopping the application or service fails.	486
armfover.exe	Moves or fails over groups.	487
armgstrt.exe	Starts groups.	488
armgstop.exe	Stops groups.	489
armloadc.exe	Start or stop the application or service, or suspends or resumes the monitoring.	490
armpause.exe	Suspends scripts. This command can be used as a debugger. Permit the interaction with desktop. You can configure the setting for the interaction with desktop on the Service of Administrative Tools on Programs .	492
armsleep.exe	Suspends the script execution for a specified time.	493
armnsadd.exe	Starts sharing a network drive. This command functions in the same way as the net share <i>shared_name=path_name</i> .	494
armnsdel.exe	Releases the network sharing forcibly specified by the net share <i>shared_name=path_name</i> .	495
armwsset.exe	Sets the IP address returned by executing gethostbyname() on the local server to the specific application.	496
Commands that can be used only outside scripts		
command	Description	Page
armdelay.exe	Sets or refers to the delay time of the EXPRESSCLUSTER service startup on the NEC Express5800/ft series or servers that have equivalent fault-tolerant functions.	498
armem.exe	Sets or refers to the mode at emergency shutdown.	499
armstdn.exe	Shuts down a cluster.	500
armmode.exe	Returns servers to a cluster.	501
mdopen.exe	Permits an access to the mirror disk.	502
mdclose.exe	Prohibits an access to the mirror disk.	503

Important:

The installation directory contains executable-format files and script files that are not listed in this guide. Do not execute these files other than EXPRESSCLUSTER. Any problems caused by not using EXPRESSCLUSTER will not be supported.

Displaying the messages on EXPRESSCLUSTER clients (`armbcast` command)

armbcast.exe: the `armbcast.exe` command displays the messages on EXPRESSCLUSTER clients.

Command line:

Format 1 `armbcast.exe /ID n /S group_name`

Format 2 `armbcast.exe /MSG msg_strings [/A | /S group_name]`

Description	This command displays the default or optional messages on monitors of clients.	
Parameter	<code>/ID n</code>	<p>Displays a message that corresponds to the ID specified in <i>n</i>. You need to register this message in advance.</p> <p>This parameter cannot be specified with <code>/MSG</code>.</p>
	<code>/MSG msg_strings</code>	<p>Displays a character string <i>msg_strings</i> on clients. The maximum size of a string is 127 bytes.</p> <p>When the character string includes spaces, enclose it in double quotation marks. When you use double quotation marks in the string, describe them as <code>\</code>.</p> <p>This parameter cannot be specified with <code>/ID</code>.</p>
	<code>/A</code>	Displays a message on all clients.
	<code>/S group_name</code>	<p>Displays a message on all clients that use the group specified in <i>group_name</i>.</p> <p>When using a Format 1, you cannot omit this parameter.</p> <p>When using a Format 2, you cannot specify this parameter with <code>/A</code>. You can omit <code>/A</code> and <code>/S</code>. When omitted, <code>/A</code> is assumed to be specified.</p>
Return Value	0	Success
	7	The EXPRESSCLUSTER Server service has not been started.
	9	The parameter is invalid.
Notes	This command cannot be used when recovering servers to a cluster (when the environment variable of start script "CLP_EVENT" is "RECOVER").	
Remarks	This command can be used only in scripts.	

Registering the messages on a log file or an alert log (armlog command)

armlog.exe: The `armlog.exe` command registers the messages on a log file or an alert log.

Command line:

```
armlog.exe log_strings [/arm]
```

Description This command registers specified messages to a log file or an alert log. The messages are registered on the log file (`arm.log`) of the server on which this command is run. They are also displayed on the Alert view of the WebManager.

Parameter *log_strings* Specifies a message string to be registered. The maximum size of a string is 128 bytes (when a string is displayed on the Alert view, the size is 111 bytes). When the character string includes spaces, enclose it in double quotation marks. When you use double quotation marks in the string, describe them as `\`.

/arm Displays a message on the Alert view of the WebManager. When this parameter is omitted, a message is registered only to a log file.

Return Value

0	Success
1	Logs were not registered due to an error.
8	The EXPRESSCLUSTER Server service has not been started.
9	The parameter is invalid.

Remarks This command can be specified only in scripts.

Starting the applications or services (armload command)

armload.exe: the `armload.exe` command starts applications or services.

Command line: (Format 1: application Format 2: service)

```
Format 1 armload.exe watchID [[/U user-name] | [/WINDOW size]]
        [/WIDKEEP] [/C [CMD]] [<mode>] exec-name
        [parameter-1 parameter-2 .....]
```

For <mode>, one of the following can be specified.

```
* /W
* /M [/FOV [/CNT count]]
* /R retry [/H hour] [/SCR] [/FOV [/CNT count]]
  [/INT time]
```

```
Format 2 armload.exe watchID /S [/A] [/WIDKEEP] [/WAIT time]
        [/C [CMD]] [<mode>] service-name
        [parameter-1 parameter-2 .....]
```

For <mode>, one of the following can be specified.

```
* /M [/FOV [/CNT count]]
* /R retry [/H hour ] [/SCR] [/FOV [/CNT count]]
  [/INT time]
```

Description	<p>This command starts applications or services.</p> <p>A failover or restart occurs when the started application or service fails (when specified as a monitoring target). Monitoring failures continues until the application or service is terminated by ARMKILL.</p> <p>A failure is a loss of a process for the application, and a service stop (SERVICE_STOPPED) and abnormal termination for the service.</p>
Parameter	<p><i>watchID</i> ID for monitoring.</p> <p>This ID is used for terminating the application or service by the ARMKILL command. Be aware of the following notes when using this parameter:</p> <ul style="list-style-type: none"> * The same IDs cannot be specified within a cluster. * You cannot use IDs starting with “NEC” since those are already allocated (IDs of “NEC_product_name+ something extra” are used for the product programs of NEC). * Specify the ID with alphanumeric characters of up to 255 bytes (case-sensitive).

/U <i>user-name</i>	<p>Specifies the user account name that runs the application.</p> <p>This parameter is optional. When omitted, the application is started with the local system account.</p> <ul style="list-style-type: none"> * This parameter cannot be specified in Format 2. * When specifying this parameter, refer to (3) on Note.
/WINDOW <i>size</i>	<p>Specifies the window size of an application. The following can be specified to <i>size</i>.</p> <p><i>maximum</i> The application or service starts with windows of a maximum size.</p> <p><i>normal</i> The application or service starts with windows of a size specified by the application.</p> <p><i>hide</i> The application or service starts with hidden windows.</p> <p>This parameter is optional. When omitted, the application or service starts with windows of a minimum size.</p> <ul style="list-style-type: none"> * This parameter cannot be specified in Format 2.
/C [CMD]	<p>Specifies the format to pass the parameter-n to the application or service. Specify this option when the parameter-n ends with an escape character (\). Refer to the following examples to specify the parameter-n.</p> <p>Example 1) when the command passes “c:\” to app.exe. ARMLOAD WatchID /C app.exe c:\</p> <p>Example 2) when the command passes “c:\Program Files\” to app.exe. Enclose “c:\Program Files\” in double quotation marks, and add escape characters for the number of escape characters in the end. armload WatchID /C app.exe “c:\Program Files\”</p> <ul style="list-style-type: none"> * Specify “CMD” as well when specifying this parameter and the type of application is command.
/WIDKEEP	<p>Starts or stops the application or service with no monitoring parameter (/M, /R) specified by using the EXPRESSCLUSTER Task Manager or the ARMLoad command.</p> <ul style="list-style-type: none"> * This option is ignored when /W, /M or /R is specified.
/W	<p>Waits until the execution of the application is terminated. When this parameter is specified, controls are not returned from this command until the application terminates. This parameter is optional.</p> <ul style="list-style-type: none"> * This parameter cannot be specified with /M or /R. * This parameter cannot be specified in Format 2.

<i>/M</i>	Monitors the application or service. This parameter is optional. When omitted, monitoring is not performed. * This parameter cannot be specified with <i>/W</i> or <i>/R</i> . * When you use this parameter without specifying <i>/FOV</i> , servers are shut down at failure.
<i>/R retry</i>	Monitors the application or service and specifies the threshold of the restart count. This parameter is optional. When omitted, monitoring is not performed. * The value from 1 through 9 can be specified. * This parameter cannot be specified with <i>/M</i> or <i>/W</i> .
<i>/H hour</i>	Specifies the time to reset the restart count of the application or service to 0. The time can be specified by hours. When the application or service starts and operates normally during the time specified with the <i>/H</i> option, the restart count is reset to 0. * The value from 1 through 24 can be specified. * Restart count is not reset if this parameter is omitted with the parameter <i>/R</i> specified.
<i>/SCR</i>	When this parameter is specified, the application or service is restarted by scripts. This parameter is optional. * The application or service is restarted by itself if this parameter is omitted with the parameter <i>/R</i> specified.
<i>/FOV</i>	Fails over groups when the restart count threshold is exceeded on the application or service monitoring. This parameter is optional. * Servers are shut down if this parameter is omitted with the parameter <i>/M</i> or <i>/R</i> specified.
<i>/CNT count</i>	A failover is not performed when the number of failovers already performed exceeds the count specified by this option. This is to avoid servers from repeating failing over endlessly. The number of failovers is counted for each server. The value from 1 through 255 can be specified. When omitted, 8 is specified. The failover count is reset to 0 on a specific server when: the normal status continues more than 1 hour the server is restarted the failover group is activated
<i>exec-name</i>	Specifies an executable file name. * This parameter cannot be specified in Format 2.
<i>parameter-n</i>	Passed to an executable file. This parameter is optional.
<i>/S</i>	Specifies that the target to be started is a service. * This parameter cannot be specified in Format 1.

/A Specify this parameter when you want to specify the service as a monitoring target even though it is already started.

This parameter is optional.

* This parameter cannot be specified in Format 1.

/WAIT time Specifies the time to wait for the completion of a service startup by the second. When this parameter is specified, this command does not return controls while waiting for the service to complete startup (*SERVICE_RUNNING*) or within the wait time. This parameter is optional. When omitted, the command does not wait for the completion of a startup.

* This parameter cannot be specified in Format 1.

* The value from 0 through 3600 can be specified. When 0 is specified, the command waits for the completion of a startup endlessly.

/INT time Specifies restart interval of the application or service, or scripts by the second. This parameter is optional. When omitted, 0 (second) is specified to the restart interval.

* This parameter is valid when */R* or */SCR* option is specified.

* The value from 0 through 3600 can be specified.

service-name Specifies the service name.

* This parameter cannot be specified in Format 1.

For *service-name*, specify one of the following:

- (1) Specify the service name that is displayed on the **Services** on the **Administrative Tools**.
- (2) Specify *xxxx* that matches with the service name displaying "DisplayName", the key of *xxxx* of the following registry in **Services** on **Administrative Tools**.

```
HKEY_LOCAL_MACHINE\SYSTEM\CurrentControlSet\Services\xxxx
```

Example) For FTP service of IIS

Name displayed on the **Service** window

FTP Publishing Service

Name displayed on the registry

```
...\Services\MSFTPSVC
  DisplayName:REG_SZ: FTP Publishing Service
```

Format:

```
armload WatchID /S "FTP Publishing Service"
```

or

```
armload WatchID /S MSFTPSVC
```

Return Value	0	Success (the target application or service has started)
	1	Cannot start the target application or service
	2	Cannot perform process monitoring
	3	The specified watchID is already used.
	4	Time-out occurred while waiting for the service to complete startup (the service is starting up).
	8	The EXPRESSCLUSTER Server service is not started.
	9	The parameter is invalid.

- Remarks**
- (1) This command can be used only in scripts.
 - (2) Multiple parameters can be specified for a command that is passed to an executable file.
 - (3) The figure below indicates operations performed when the application or service started by ARMLOAD fails.
 1. The application or service is started by ARMLOAD
 2. A failure occurs
 3. Threshold check
 4. When the threshold is not exceeded, the application or service is restarted by scripts.
 - 4-1: Stop script execution 4-2: Start script execution
 5. When the threshold is exceeded, a failover occurs or a server shuts down
 - 5-1: Stop script execution 5-2: Fails over to another EXPRESSCLUSTER server

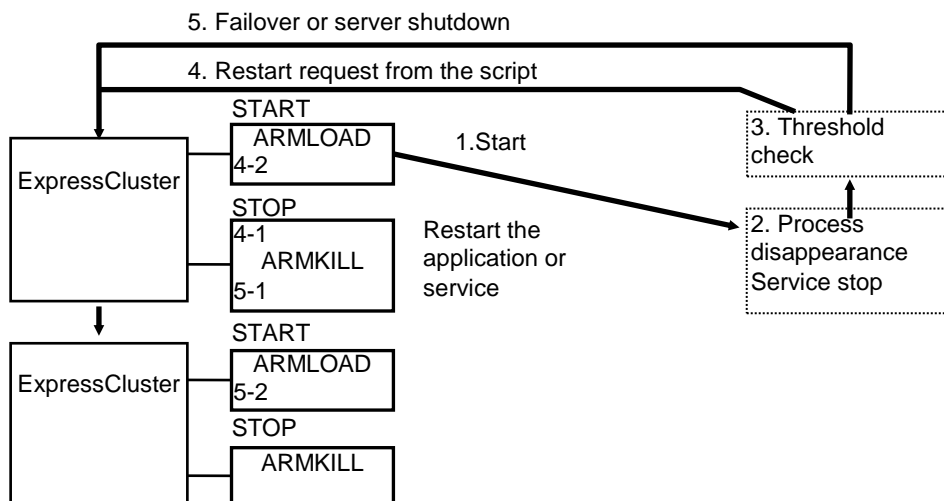

Notes

- (1) This command can be specified only in scripts.
- (2) When you start the application with GUIs without specifying an account, select **Allow service to interact with desktop** on the EXPRESSCLUSTER Server service. When not selected, GUIs of the application are not displayed.
- (3) When you specify a user account, it should have “local logon” permission. For information on the user permissions, see the help of the domain user administrator.

When you specify the domain of an account explicitly, specify the following. Note that the domain name and the user name should be within 15 characters.

When the account is a local administrator:

```
armload watchid /u administrator ap.exe
```

When the account is a domain administrator:

```
armload watchid /u domain\administrator ap.exe
```

- (4) When you use the monitoring function (/M option) of the ARMLoad command, specify Dr. Watson (DRWTSN32.EXE) as a default debugger used by the operating system.
To check this setting, go to the registry
\\HKEY_LOCAL_MACHINE\Software\Microsoft\Windows NT\CurrentVersion\AeDebug
and find the value with the name “Debugger” or “Auto.”
Check if the value of “Auto” is set to 1, and “Debugger” to “DRWTSN32.”

When the setting values are different from those, change the settings to use Dr. Watson in addition to the default debugger you are using. For this setting, start Dr. Watson by running the `drwtsn32 -i` command on the command prompt.

At OS installation, the value of “Auto” is set to 1, and “Debugger” to “drwtsn32” (Dr. Watson). Make the setting so that the debugger is not automatically started, nor monitoring processing is prevented.

- (5) Applications not suitable for ARMLoad monitoring function
The applications whose processes do not stay resident persistently are not suitable for the process monitoring (*). Since the process monitoring is assumed to monitor processes that stay persistently and do not terminate by themselves, it determines that an error occurs on an application when the started process is terminated.

(*): The following applications are examples:

An application whose process started by ARMLoad does not stay resident persistently

An application whose process started by ARMLoad starts its child process, and the process started first does not stay resident persistently (ARMLoad only monitors the process it started)

- (6) The application that requires GUIs may be terminated when it is started by the ARMLoad command and logged off. To prevent the application from being terminated, start it with an account (/U option).
- (7) If you use this command with the [/U] option and any account other than built-in Administrator, the command might fail.

- (8) If you use this command with the [/s] option, it is recommended to set the recovery operation not to be performed by the service control manager so that applications other than EXPRESSCLUSTER will not control services.
If a service is set to restart upon the recovery operation by the service control manager, an unexpected action might be performed due to duplication with the recovery operation by EXPRESSCLUSTER.

Limitations

- (1) The ARMLoad command with an account cannot be used in a batch program that is run with an account.
- (2) The application that is run with an account (including a child process) cannot use the LogonUser () function.
- (3) Do not execute a 16-bits application since it cannot be terminated by the ARMKILL command.
- (4) When including spaces in a parameter, enclose it in quotation marks.
Example) ARMLoad Wid1 "\Program Files\Application.exe"
- (5) Only the process that is started by the ARMLoad command can be terminated by the ARMKILL command.
- (6) Do not run the applications (XXXX.EXE) that EXPRESSCLUSTER provide.

The ARMLoad command may terminate abnormally (return value 1: Cannot start the target application or service) if the application with an account is started while it cannot access the domain controller (due to a failed server or network disconnection, etc.).

Terminating the application or service (armkill command)

armkill.exe: the `armkill` exe command terminates the application or service.

Command line:

```
armkill.exe watchID [/C | /T time]
```

Description	<p>This command terminates the application or service that was started up by the ARMLOAD command.</p> <p>When one service is operated (monitoring target) with several ARMLOAD commands (when several ARMLOAD commands with /A option operate one service), the service is not terminated until ARMKILL is run for all <i>watchID</i>.</p>
Parameter	<p><i>watchID</i> Specifies the monitoring ID of the application or service you want to terminate.</p> <p>Use the ID specified when the application or service was started up by the ARMLOAD command.</p> <p><i>/C</i> Cancels the monitoring of the application or service but does not terminate the application or service.</p> <p>This parameter is optional. When omitted, the application or service is terminated. This parameter cannot be specified with the <i>/T</i> parameter.</p> <p>Do not use this option when stopping an application that was started by specifying the <i>/U</i> option of the ARMLOAD command.</p> <p><i>/T time</i> Sets the termination wait time of the application or service.</p> <p>The range that can be specified is from 0 to 3600 seconds. If 0 is specified, the command waits for the completion of termination of the application or service endlessly. This parameter is optional. When omitted, the wait time is set to 40 seconds. This parameter cannot be specified with the <i>/C</i> parameter.</p>
Return Value	<p>0 Success (the target application or service was terminated).</p> <p>1 The application or service has already been terminated.</p> <p>2 The application or service was not terminated. (The application or service is being terminated.)</p> <p>8 The EXPRESSCLUSTER Server service has not been started.</p> <p>9 The parameter is invalid.</p>

Remarks

- (1) This command can be specified only in scripts.
- (2) To terminate the application, this command sends the `WM_CLOSE` message to it. If the application does not terminate within the specified time (`/T time`), this command executes the `TerminateProcess()` for the target application to forcibly terminate the application process.
- (3) To terminate the service, the requirement to stop the service is sent to the service control manager (SCM). When terminating the service has not been completed within the specified time (`/T time`), the return value of 2 is returned.
- (4) If `/C` is specified on this command, the application or service cannot be terminated by `ARMKILL`.

Waiting for the start or stop of groups (armgwait command)

armgwait.exe: the `armgwait.exe` command waits for the start or stop of groups.

Command line:

```
armgwait.exe group_name [time-out] [/stop]
```

Description	This command waits for the start or stop of groups. This command waits until the status of a group becomes active (when waiting for activation) or inactive (when waiting for termination), or until the specified time is exceeded.
Parameter	<p><i>group_name</i> Specifies a name of the group whose completion of start or stop the command waits for.</p> <p><i>time-out</i> Specifies the time-out by the second. When this parameter is omitted, the time-out value is set to default (120 seconds).</p> <p>/stop Waits until the group is terminated. When this parameter is omitted, this command waits for the startup of the group.</p>
Return Value	<p>0 The status of the failover group is active or inactive.</p> <p>1 The time-out has elapsed.</p> <p>7 The EXPRESSCLUSTER Server service has not been started.</p> <p>8 The specified group does not exist.</p> <p>9 The parameter is invalid.</p>
Notes	Do not run this command directly from the start or stop script. When using this command from those scripts, prepare the batch file on which the command is described, and then run the batch file on the start or stop script by writing "START <i>batch_file_name</i> " on it.
Remarks	This command can be run only in scripts. Follow the process on Note when using this command on the start or stop script.

Exclusive control between servers command (`armcall` command)

`armcall.exe`: the `armcall.exe` command runs commands or programs exclusively on nodes.

Command line:

```
armcall.exe [/L lockname ] exec_name [parameter ...]
```

Description This command executes a program from a script without terminating it, and returns the control to the script that is invoked again. This program is executed exclusively between nodes.

Parameter

<code>/L <i>lockname</i></code>	Specifies the lock name. When this option is omitted, "Default" is specified for the name. The commands are run exclusively for each lock name specified by this parameter.
<code><i>exec_name</i></code>	Specifies the command or program to be run.
<code><i>parameter</i> ...</code>	Specifies the command line information required to run the program specified in <code><i>exec_name</i></code> .

Return Value

0	Success
8	The program was not run due to an error.
9	The parameter is invalid.

Remarks This command can be run only in scripts.

Examples

When the process <A> must be run on all nodes, and the running of process <A> must be exclusive between nodes:

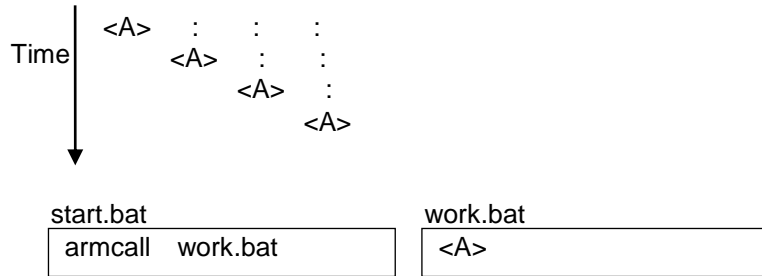

When the process <A> should be run only on one node and the process should be run at all nodes, and the process must be started after the completion of the process <A>.

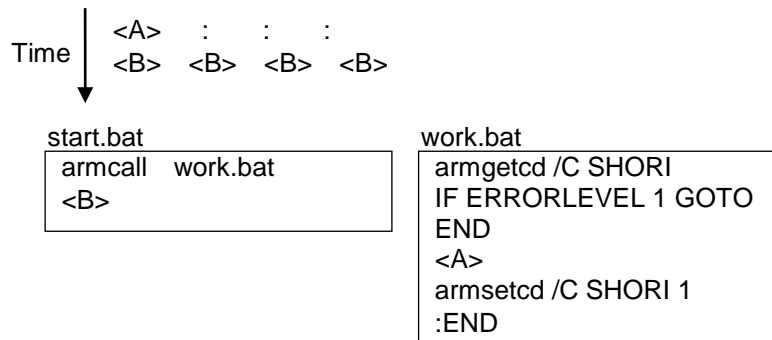

Retrieving the cluster wide variable or local variable (armgetcd command)

armgetcd.exe: the `armgetcd.exe` command retrieves the cluster wide variable or local variable.

Command line:

```
armgetcd.exe [/C] variable
```

Description	This command retrieves the setting value of the cluster wide variable or local variable specified by the <code>armsetcd</code> command.	
Parameter	<code>/C</code>	Retrieves the setting value of the cluster wide variable. When this parameter is omitted, the value of the local variable is retrieved.
	<i>variable</i>	Specifies the variable name set by the <code>armsetcd</code> command.
Return Value	0	The value could not be retrieved due to an error.
	1-255	The value set by the <code>armsetcd</code> command is returned.
Remarks	This command can be specified only in scripts. If you specify the variable name which is not set by the <code>armsetcd</code> command, 0 is returned.	

Setting the cluster wide variable or local variable (armsetcd command)

armsetcd.exe: The `armsetcd.exe` sets the cluster wide variable or local wide variable.

Command line:

```
armsetcd.exe [/C] variable value
```

Description	<p>This command sets the cluster wide variable or the local variable.</p> <p>The setting value of the variable set by this command can be referred by using the <code>armgetcd</code> command on the same or other scripts.</p> <p>The cluster wide variable is shared between servers in a cluster. The variable set by the <code>armsetcd</code> command on one server can be referred or changed on another server.</p> <p>The local variable is valid only on the server on which the <code>armsetcd</code> command is run.</p>						
Parameter	<table> <tr> <td style="vertical-align: top;"><i>/C</i></td> <td> <p>Sets the variable as a cluster wide variable.</p> <p>When this parameter is omitted, the variable is set as a local variable.</p> </td> </tr> <tr> <td style="vertical-align: top;"><i>variable</i></td> <td> <p>Specifies the name of the variable to be set. Specify the name with up to 127 alphanumeric characters. (The name is case-sensitive.)</p> </td> </tr> <tr> <td style="vertical-align: top;"><i>value</i></td> <td> <p>Specifies the value to be set to the variable on <i>variable</i> in integers from 1 through 255.</p> </td> </tr> </table>	<i>/C</i>	<p>Sets the variable as a cluster wide variable.</p> <p>When this parameter is omitted, the variable is set as a local variable.</p>	<i>variable</i>	<p>Specifies the name of the variable to be set. Specify the name with up to 127 alphanumeric characters. (The name is case-sensitive.)</p>	<i>value</i>	<p>Specifies the value to be set to the variable on <i>variable</i> in integers from 1 through 255.</p>
<i>/C</i>	<p>Sets the variable as a cluster wide variable.</p> <p>When this parameter is omitted, the variable is set as a local variable.</p>						
<i>variable</i>	<p>Specifies the name of the variable to be set. Specify the name with up to 127 alphanumeric characters. (The name is case-sensitive.)</p>						
<i>value</i>	<p>Specifies the value to be set to the variable on <i>variable</i> in integers from 1 through 255.</p>						
Return Value	<table> <tr> <td style="vertical-align: top;">0</td> <td>Success</td> </tr> <tr> <td style="vertical-align: top;">8</td> <td>The variable was not set due to an error.</td> </tr> <tr> <td style="vertical-align: top;">9</td> <td>The parameter is invalid.</td> </tr> </table>	0	Success	8	The variable was not set due to an error.	9	The parameter is invalid.
0	Success						
8	The variable was not set due to an error.						
9	The parameter is invalid.						
Remarks	<p>This command can be run only in scripts.</p> <p>Variable names are controlled separately for the cluster wide variable and the local variable. Thus, you can set both variables with one variable name. In this case, those are operated as two different variables.</p> <p>The local variable is valid until the EXPRESSCLUSTER Server service of the server on which this command was run is terminated.</p> <p>The cluster wide variable is valid until the EXPRESSCLUSTER Server services of all servers in a cluster are terminated.</p>						

Monitoring errors on the connection to the shared resources (**armwhshr** command)

armwhshr.exe: the `armwhshr.exe` command monitors errors on the connection to the shared name.

Command line:

```
armwhshr.exe share-name ip-addr [/INT time] [/LOG log-strings]
           [/PROC exec-name parameter-1 parameter-2 ... parameter-n]
```

Description

This command monitors errors on the connection to the shared name. It checks if the ping is reached to the specified shared name server or monitors the connection error to the shared name. It registers the event log (ID:3514) when the ping is reached normally and an error occurred while connecting to the shared name.

However, the event log is not registered when the connection error is already detected. It is registered when the status of connection changes from normal to error.

With options, this command sends messages to the WebManager and starts specified executable files.

Parameter

<i>share-name</i>	Specifies a shared name (UNC name).
<i>ip-addr</i>	Specifies the IP address of a server that possesses shared name.
<i>/INT time</i>	Specifies monitoring interval (by the second). The range which can be specified is from 30 through 86400. This parameter is optional. When omitted, 180 (sec) is set for the interval.
<i>/LOG log-strings</i>	Specifies the character string to be reported to the WebManager when an error occurs on the connection to a shared name. It is reported to the WebManager every time an error on the connection to the shared name is detected. Maximum of 111 bytes can be specified for the string. If the string includes spaces, enclose it in double quotation marks. When you use the double quotation marks in the strings, describe them with <code>\ (")</code> . This parameter is optional.
<i>/PROC exec-name</i>	Specifies the name of an executable file that is started when an error occurs on the connection to the shared name. The executable file is started when the status of shared name connection changes from normal to abnormal. This parameter is optional.
<i>parameter-n</i>	This parameter is passed to the executable file. This parameter is optional.

Return Value	0	Success
	1	The parameter is invalid.
	2	Insufficient memory
	8	The EXPRESSCLUSTER Server service has not been started.

How to use When using the ARMWHSR command, configure the following settings.

- (1) Registering the user account
Register the user account with an administrator right.
- (2) Describing the ARMWHSR command in scripts
Create a new failover group for monitoring errors on the connection to the shared name(*), and describe the ARMWHSR command in scripts.

* Setting a failover group

1. Add only one server to the **Servers that can run the Group** by clicking the **Startup Server** tab on the **Group Properties**.

For example, to monitor errors on the connection to the shared name (temp) of the server (server name: server public LAN IP address: 100.100.100.1), describe the following in the start script:

```
(Lines in the script that is run when CLP_EVENT is START)
ARMLoad watchID /U Administrator
ARMWHSR \\server\temp 100.100.100.1
```

Describe the following in the stop script

```
(Lines in the script that is run when CLP_EVENT is START)
ARMKILL watchID
```

Usage example

This command is used to confirm whether the local disk of the server can be accessed from the network. On the cluster system with 2 servers, accessibility to local disks on both servers from the network can be checked by monitoring another server from both servers. The following indicates the examples of configuration and script descriptions.

Example:

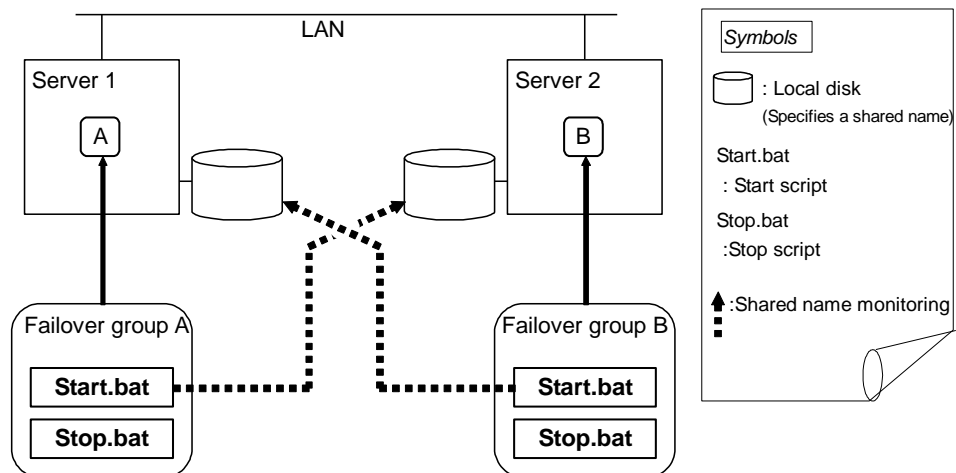

Server Information:

	Server1	Server2
Server name	server1	server2
Public LAN IP address	100.100.100.1	100.100.100.2
Shared name	(1)share1 (2)share3	(1)share2

Script example

(1) Start.bat of Server 1

```
IF "%CLP_EVENT%" == "START" GOTO NORMAL
GOTO EXIT
:NORMAL
ARMLoad W1 /U Administrator ARMWHSR \\server2\share2
100.100.100.2
:EXIT
EXIT
```

(2) Stop.bat of Server 1

```
ARMKILL W1
EXIT
```

(3) Start.bat of Server 2

```
IF "%ARMS_EVENT%" == "START" GOTO NORMAL
GOTO EXIT
:NORMAL
ARMLoad W2 /U Administrator ARMWHSR \\server1\share1
100.100.100.1
ARMLoad W3 /U Administrator ARMWHSR \\server1\share3
100.100.100.1
:EXIT
EXIT
```

(4) Stop.bat of Server 2

```
ARMKILL W2
ARMKILL W3
EXIT
```

Notes This command can be specified only in scripts.

Controlling the applications or services started by the armload command (EXPRESSCLUSTER Task Manager)

armaswth.exe: the `armaswth.exe` command lists applications or services started by the armload command in GUI.

Command line:

`armaswth.exe`

Description This command lists the applications or services started by the armload command in GUI. In addition, it can start or stop the applications or services, and suspend or resume the monitoring in the same way as the armload command.





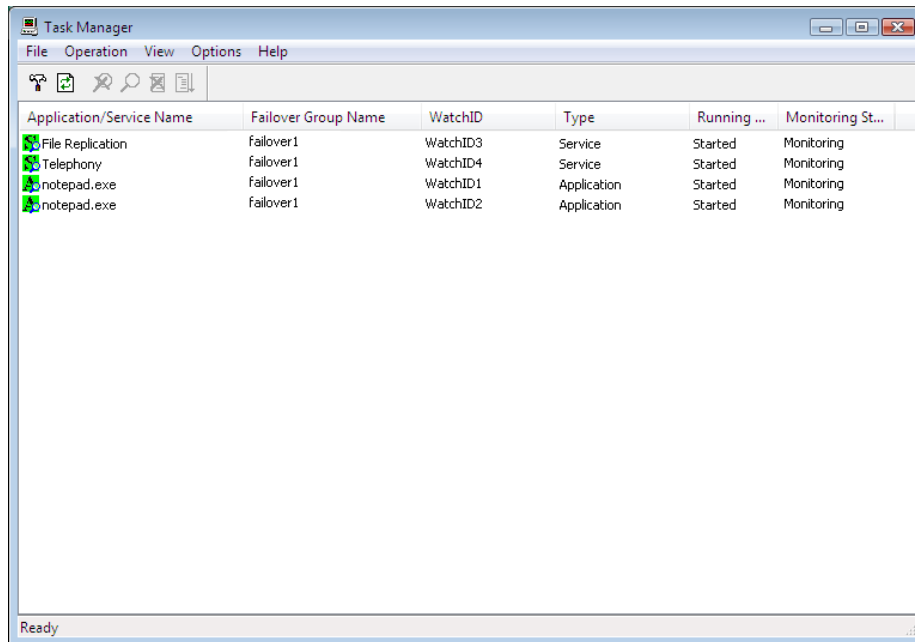

Remarks This command can be specified both in and outside scripts.

Screen image





Description:

- **Application/Service Name**
Displays the names of applications or services started by the ARMLOAD command. Icons indicate the following status:

- : Application that is not monitored
- : Application that is being monitored
- : Application that is not a monitoring target
- : Service that is not monitored
- : Service that is being monitored
- : Service that is not a monitoring target

Background colors of icons indicate the following status:

- : Started / Being started
- : Stopped / Being stopped

- **Failover Group Name**
Displays the group names that the started applications or services belong to
- **Type**
Displays the types (application or service)
- **Running Status**
Started: Application or service has started
Stopped: Application or service has not started
Starting: Application or service is being started
Stopping: Application or service is being stopped
- **Monitoring status**
Monitoring: Application or service is being monitored
Not monitoring: Application or service is not being monitored
Not monitored: Application or service is not a monitoring target (is not set as a monitoring target but started by the ARMLOAD command)

Sort

Click any of **Application/Service Name**, **Failover Group Name**, **WatchID**, **Type**, **Running Status**, or **Monitoring Status** to sort the list into ascending or descending order of the clicked item.

Operation

Same as the ARMLOADC command, four operations of monitoring stop, monitoring resume, stop, start can be performed. Operations that can be performed vary depending on the status of the application or service start and the monitoring. For details, see “ARMLOADC command.”

Select the application on the list (you cannot select multiple applications), and operate it by one of the following ways:

- **Operation** menu
- Toolbar
- Shortcut menu displayed by right-clicking the application name (shown below)

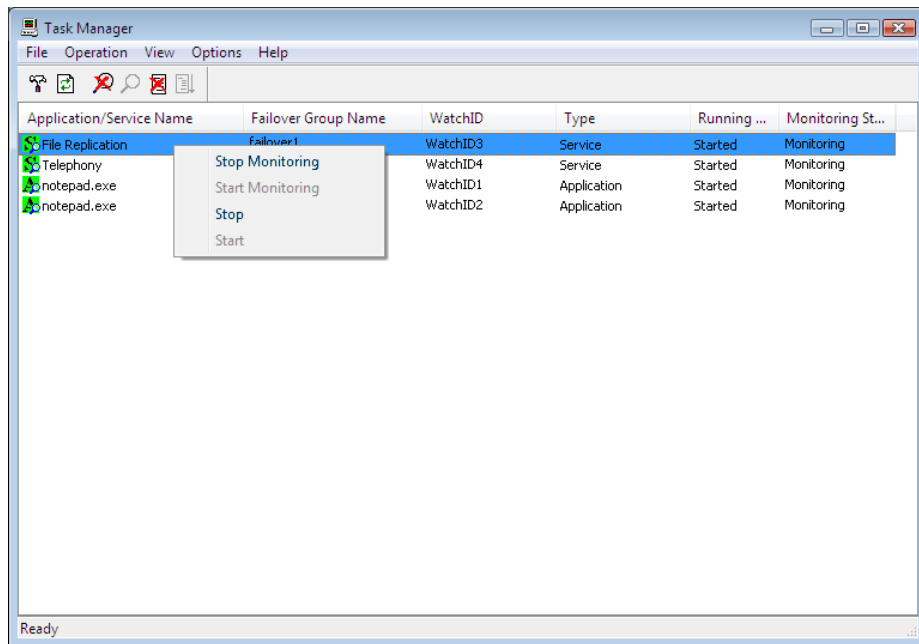

Settings

To configure the settings, click **Settings** on the **Option** menu or on the toolbar.

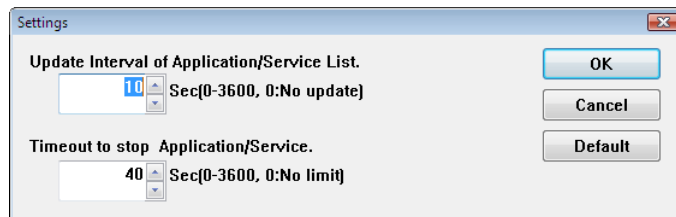

Update Interval of Application/Service List

Specify the interval to automatically update the application or service list by the second. The value from 0 through 3600 can be specified. When 0 is set, the list is not updated automatically. The default is 10 (seconds).

Timeout to stop Application/Service

Specify the wait time to stop when stopping the application or service by the second. The value from 0 through 3600 can be specified. When 0 is set, the termination of the application or service is waited endlessly. The default is 40 (seconds). If the application or service is not stopped after the stop time is exceeded, the application is forcibly stopped. This setting is used only when the application or service is stopped by the EXPRESSCLUSTER Task Manager.

Shutting down the server (`armdown` command)

`armdown.exe`: the `armdown.exe` command shuts down the server.

Command line:

```
armdown.exe [reboot | off | stop]
```

Description	This command stops the EXPRESSCLUSTER service of the server on which this command is run, and shuts down the server.	
Parameter	No parameter	Shuts down the server and turns off the power.
	<code>reboot</code>	Shuts down the server and reboots it. This parameter cannot be specified with “OFF” or “stop” parameter.
	<code>off</code>	Shuts down the server and turns off the power. This parameter cannot be specified with “reboot” or “stop” parameter.
	<code>stop</code>	Stops the EXPRESSCLUSTER Server service without shutting down the server. This parameter cannot be specified with “reboot” or “OFF” parameter.
Return Value	0	Success (The server shutdown has started).
	8	The EXPRESSCLUSTER Server service is not running.
	9	The parameter is invalid.
Notes	Do not run this command directly from the start or stop script. When using this command from those scripts, prepare the batch file on which the command is described, and then run the batch file on the start or stop script by writing “START <i>batch_file_name</i> ” on it.	
Remarks	This command can be specified both in and outside scripts. When running this command on the start or stop script, follow the steps on Notes. To shut down whole cluster normally, run the <code>armstdn</code> command.	

Moving or failing over a group (armfover command)

armfover.exe: the `armfover.exe` command moves or fails over a group

Command line:

```
armfover.exe [/F] group_name
```

Description	This command moves or fails over a group. A group is moved or failed over to the server next to the current server, in ascending order, on which the group can be started. If a subsequent server does not exist, the group is moved or failed over to the first server.	
Parameter	/F	Fails over a group. When this parameter is omitted, a group is moved. When a group is failed over, "FAILOVER" is set to the environment value of the start script "CLP_EVENT" on the destination server. When a group is moved, "START" is set to the environment value of the start script "CLP_EVENT" on the destination server.
	<i>group_name</i>	Specifies the name of the group to be moved or failed over.
Return Value	0	Success (the group was moved or failed over).
	7	The specified group has not been started.
	8	The EXPRESSCLUSTER Server service has not been started.
	9	The parameter is invalid.
Notes	Do not run this command directly from the start or stop script. When using this command from those scripts, prepare the batch file on which the command is described, and then run the batch file on the start or stop script by writing "START <i>batch_file_name</i> " on it.	
Remarks	This command can be specified both in and outside scripts. When running this command on the start or stop script, follow the steps on Notes.	

Starting a group (`armgstrt` command)

`armgstrt.exe`: the `armgstrt.exe` command starts a group

Command line:

```
armgstrt.exe group_name [host_name]
```

Description	This command starts a group on a specified server
Parameter	<i>group_name</i> Specifies the name of a group to be started <i>host_name</i> Specifies the name of a server on which a group is started. When this parameter is omitted, the server is determined according to a group failover policy.
Return Value	0 Success 1 The status on which the specified operation is not available. (checking if the shared disk is powered on or not) 7 The specified group has already been started. 8 The EXPRESSCLUSTER Server service has not been started. 9 The parameter is invalid.
Notes	Do not run this command directly from the start or stop script. When using this command from those scripts, prepare the batch file on which the command is described, and then run the batch file on the start or stop script by writing "START <i>batch_file_name</i> " on it.
Remarks	This command can be specified both in and outside scripts. When running this command on the start or stop script, follow the steps on Notes.

Stopping a group (armgstop command)

armgstop.exe: the `armgstop.exe` command stops a group

Command line:

`armgstop.exe group_name`

Description	This command stops a group.	
Parameter	<code>group_name</code>	Specifies the name of a group to be stopped.
Return Value	0	Success
	7	The specified group has not been started.
	8	The EXPRESSCLUSTER Server service has not been started.
	9	The parameter is invalid.
Notes	Do not run this command directly from the start or stop script. When using this command from those scripts, prepare the batch file on which the command is described, and then run the batch file on the start or stop script by writing " <code>START batch_file_name</code> " on it.	
Remarks	This command can be specified both in and outside scripts. When running this command on the start or stop script, follow the steps on Notes.	

Starting or stopping the application or service, suspending or resuming the monitoring (armloadc command)

armloadc.exe: the `armloadc.exe` command starts or stops the application or service, or suspends or resumes the monitoring.

Command line:

```
armloadc.exe watchID /W mode [/T time]
```

Description	<p>This command starts or stops the application or service, or suspends or resumes the monitoring.</p> <p>This command terminates when the operations of starting or stopping the application or service is completed.</p>								
Parameter	<p><i>watchID</i> This ID is for monitoring. Specify the ID used when the application or service is started by the <code>ARMLOAD</code> command.</p> <p><i>/W mode</i> Controls the monitoring. The following values can be specified for <i>mode</i>.</p> <table> <tr> <td><code>pause</code></td> <td>Suspends the monitoring of the application or service.</td> </tr> <tr> <td><code>continue</code></td> <td>Resumes the monitoring of the application or service. When the application or service has terminated, the monitoring is resumed after a startup.</td> </tr> <tr> <td><code>start</code></td> <td>Starts the application or service.</td> </tr> <tr> <td><code>stop</code></td> <td>Terminates the application or service. When the application or service is being monitored, it is terminated after suspending the monitoring.</td> </tr> </table> <p><i>/T time</i> This parameter is valid when “continue,” “start” or “stop” is specified to <i>mode</i> of <i>/W mode</i>. When “continue” or “start” is specified to <i>mode</i> of <i>/W mode</i>:</p> <p style="padding-left: 2em;">Specifies the wait time to start the service (this parameter is invalid for the application). The value from 0 through 3600 (seconds) can be specified. When 0 is specified, the command waits for the startup of the service endlessly. This parameter is optional. When omitted, the command only starts the service and returns the control without waiting for completion of start.</p> <p>When “stop” is specified to <i>mode</i> of <i>/W mode</i>:</p> <p style="padding-left: 2em;">Specifies the wait time to stop the service. The value from 0 through 3600 (seconds) can be specified. When 0 is specified, this command waits for the termination of the application or service endlessly. This parameter is optional. When omitted, the command waits for maximum of 40 seconds.</p>	<code>pause</code>	Suspends the monitoring of the application or service.	<code>continue</code>	Resumes the monitoring of the application or service. When the application or service has terminated, the monitoring is resumed after a startup.	<code>start</code>	Starts the application or service.	<code>stop</code>	Terminates the application or service. When the application or service is being monitored, it is terminated after suspending the monitoring.
<code>pause</code>	Suspends the monitoring of the application or service.								
<code>continue</code>	Resumes the monitoring of the application or service. When the application or service has terminated, the monitoring is resumed after a startup.								
<code>start</code>	Starts the application or service.								
<code>stop</code>	Terminates the application or service. When the application or service is being monitored, it is terminated after suspending the monitoring.								

Return Value	0	Success
	1	The status is invalid.
	2	The application or service was not stopped. (The application or service is being started or stopped.)
	7	An error occurred in WIN32API.
	9	The parameter is invalid.

- Remarks**
- (1) This command can be specified both in and outside scripts.
 - (2) To terminate the application, send WM_CLOSE message to the application. When the application is not terminated within the specified time (/T *time*), run TerminateProcess() to forcibly terminate the application process.
 - (3) To start or stop the service, send requests for start or stop of the service to the service control manager (SCM). When the start or stop has not been completed within the specified time (/T *time*), the return value of 2 is returned.
 - (4) Refer to the table below for the values that can be specified in *mode*. If *mode* is invalid, the return value of 1 is returned.

Notes Before stopping the service (mode = stop), suspend the monitoring of watchID (mode=pause) which is monitoring the same service name, if any. A service error is detected (event ID=3506 - 3510) if the service is stopped without suspending the monitoring.

Application/Service specification matrix

Status Mode	Monitoring				Suspending monitoring			
	Started	Starting	Terminating	Terminated	Started	Starting	Terminating	Terminated
pause	O	O	X	-	X	X	X	X
continue	X	X	X	-	O	O	O (*2)	O (*2)
start	X	X	X	-	X	X	X	O
stop	O (*1)	O	X	-	O	O	X	X

O: Executable X: Not executable (Invalid status) -: This combination does not exist.

(*1) When "stop" is executed, monitoring of the application or service is suspended, and the application and service is stopped.

(*2) When "continue" is executed, the application and service is started, and monitoring of the application or service is resumed.

Suspending the script execution until the user's direction (`armpause` command)

armpause.exe: the `armpause.exe` command displays a message box, and suspends the script execution until the user clicks **OK**.

Command line:

```
armpause.exe msg_strings
```

Description This command displays the message box and suspends the script execution. When the user clicks **OK** in the message box, script execution is resumed.

Parameter *msg_strings* Specifies the character string to be displayed on the message box. Maximum of 128 bytes can be specified.

Return Value

0	Displaying the message was terminated.
1	The message cannot be displayed.
9	The parameter is invalid.

Notes To use this command in scripts, select **Allow service to interact with desktop** on the properties of the EXPRESSCLUSTER Server service.

Remarks This command can be specified both in and outside scripts.

Suspending the script execution for the specified time (armsleep command)

armsleep.exe: the `armsleep.exe` command suspends the script execution until the specified time is exceeded.

Command line:

```
armsleep.exe seconds [/NOLOG]
```

Description	This command suspends the script execution until the specified time is exceeded.	
Parameter	<i>seconds</i>	Specifies the time to suspend the script execution by the second.
	/NOLOG	When this parameter is specified, the execution of this command is not registered to the log file (<code>arm.log</code>).
Return Value	0	Success
	9	The parameter is invalid.
Remarks	This command can be specified both in and outside scripts.	

Starting the network sharing of the directory (armnsadd command)

armnsadd.exe: the `armnsadd.exe` command starts the network sharing of the directory.

Command line:

```
armnsadd.exe share_name path
```

Description	This command starts the network sharing of the directory. This is the same function as “ <code>net share <i>shared_name=path_name</i>.”</code> ”
Parameter	<i>share_name</i> Specifies the shared name of the network sharing to be started. <i>path</i> Specifies the directory to be shared by entering full path.
Return Value	0 Success 1 The parameter is invalid. 2 The path name cannot be found. 3 The shared name is invalid. 5 No access right. 7 Insufficient memory. 8 Already shared by the same shared name. 9 Other error
Remarks	This command can be specified both in and outside scripts. When using the <code>net share</code> command, it waits for the entry on the console when the shared name of more than 8 characters is specified. Thus, it is not suitable to be used in scripts. In such a case, use this command instead of the <code>net share</code> command.

Stopping the network sharing of the directory (armnsdel command)

armnsdel.exe: the `armnsdel.exe` command starts the network sharing of the directory.

Command line:

`armnsdel.exe share_name`

Description	This command stops the network sharing of the directory. This is the same function as “net share <i>shared_name</i> /delete.”	
Parameter	<i>share_name</i>	Specifies the shared name of the network sharing to be stopped.
Return Value	0	Success
	1	The parameter is invalid.
	5	The access was denied.
	8	Insufficient memory
	2310	The shared name cannot be found.
Remarks	<p>This command can be specified both in and outside scripts.</p> <p>The net share command waits for the entry on the console depending on the status of connection to the clients when the network sharing is stopped. In such a case, use this command instead of the net share command. This command stops the network sharing regardless of the status of connection to the clients.</p>	

Setting the IP address returned by `gethostbyname ()` (**armwsset command**)

armwsset.exe: the `armwsset.exe` command sets the IP address returned by the `gethostbyname ()` executed on the local server.

Command line:

Format1 `armwsset.exe [/P] path [ip_address ...]`

Format2 `armwsset.exe /L`

Format3 `armwsset.exe /DEL`

Description This command sets the IP address returned by the `gethostbyname ()` executed on the local server.

Use this command when you want to return the virtual IP address as a local server's IP address that the application retrieves.

Parameter	<code>/P</code>	<p>If this parameter is specified, settings are not deleted at system reboot. The settings are maintained after the system is restarted.</p> <p>When this parameter is omitted, settings are deleted at system reboot.</p>
	<code>path</code>	<p>Specifies the full path to the executable file of the target application.</p>
	<code>ip_address...</code>	<p>Specifies the IP address returned by the <code>gethostbyname ()</code>.</p> <p>More than one IP address can be specified by separating them by spaces.</p> <p>When multiple addresses are specified, those are set in the array returned by <code>gethostbyname ()</code> in the described order.</p> <p>When this parameter is omitted, the settings of the application specified by <code>path</code> are deleted.</p>
	<code>/L</code>	<p>Lists the current settings.</p>
	<code>/DEL</code>	<p>Deletes all current settings.</p>

Return Value	0	Success
	1	Failed to configure the settings.

- Notes** The settings by this command function only when the application downloads wsock32.dll directly as a socket library. They do not function when the application uses ws2_32.dll.
- Run this command before starting the application.
- To use this command, execute the following steps for each application in advance.
- (1) Copy wsock32.dll that is included with OS and stored in %SystemRoot%\system32 to the stored directory for the application program, and change the name to “wsock__.dll.”
 - (2) Copy wsock32.dll stored in the **accessories** folder under the EXPRESSCLUSTER installation directory to the stored directory of the application program.
 - (3) Execute the steps above on all servers that run the application.
- Remarks** This command can be specified both in and outside scripts.

Setting or displaying the start delay time (`armdelay` command)

armdelay.exe: the `armdelay.exe` command sets or displays the delay time at the EXPRESSCLUSTER service startup.

Command line:

```
armdelay.exe /N [seconds]
```

Description This command sets or displays the delay time at startup of the EXPRESSCLUSTER Server service or the EXPRESSCLUSTER Disk Agent service.

Parameter /N [*seconds*] Sets or displays the delay time at startup of the EXPRESSCLUSTER Server service or the EXPRESSCLUSTER Disk Agent by the second. These services are started after the delay time is exceeded.

For *seconds*, the value from 0 through 3600 can be specified.

When *seconds* is omitted, the current setting values are displayed.

Return Value

0	Success
7	An error occurred in WIN32API.
9	The parameter is invalid.

Remarks This command can be specified only outside scripts.

The default value of the delay time immediately after the installation is 0 second.

The delay time specified by this command is valid until the EXPRESSCLUSTER Server is uninstalled.

The delay time must be set for each server. The setting values are valid only on the server on which this command was run.

Normally, changing the delay time is not required. Setting the delay time is needed when using the EXPRESSCLUSTER on the fault-tolerant servers such as NEC Express5800/ft series.

Setting or displaying operations at the occurrence of the emergency shutdown (armem command)

armem.exe: the `armem.exe` command sets or displays the operation mode at the occurrence of emergency shutdown.

Command line:

```
armem.exe /M [shutdown | reboot | poweroff]
```

Description This command sets or displays the operation mode at the occurrence of the emergency shutdown.

Parameter

<code>/M</code>	Displays the current operation mode.
<code>/M shutdown</code>	This parameter is for compatibility. It functions in the same way as the <code>poweroff</code> parameter.
<code>/M reboot</code>	Reboots the server after shutdown.
<code>/M poweroff</code>	Powers off the server after shutdown.

Return Value

0	Success
7	An error occurred in WIN32API.
9	The parameter is invalid.

Remarks

This command can be specified only outside scripts.

The default value of the operation mode immediately after the installation is “shutdown.”

The operation mode specified by this command is valid until the EXPRESSCLUSTER Server is uninstalled.

The operation mode must be set for each server. The setting values are valid only on the server on which this command was run.

Shutting down the whole cluster (`armstdn` command)

armstdn.exe: the `armstdn.exe` command shuts down the whole cluster.

Command line:

```
armstdn.exe [reboot | off | stop]
```

Description	This command stops the EXPRESSCLUSTER service in the whole cluster, and shuts down all servers.	
Parameter	No parameter	Powers off the server after shutdown.
	reboot	Reboots the server after shutdown. This parameter cannot be specified with the <code>off</code> or <code>stop</code> parameter.
	off	Powers off the server after shutdown. This parameter cannot be specified with the <code>reboot</code> or <code>stop</code> parameter.
	stop	Stops only the EXPRESSCLUSTER Server service without shutting down the server. This parameter cannot be specified with the <code>reboot</code> or <code>off</code> parameter.
Return Value	0	Success
	8	The EXPRESSCLUSTER Server service is not running.
	9	The parameter is invalid.
Notes	Servers which cannot be communicated from the server on which this command was run are not shut down. Do not run this command while activating a group. Since a group cannot be inactivated while being activated, an emergency shutdown is executed.	
Remarks	This command can be specified only outside scripts.	

Returning the server with the status of “Suspension (isolated)” (armmode command)

armmode.exe: the `armmode.exe` command returns the server whose status is “Suspension (isolated)” to the normal status.

Command line:

`armmode.exe` [/F]

Description This command returns the server whose status is “suspension (isolated)” to the normal status.

Run this command on the server whose status is “suspension (isolated).”

Parameter No parameter Returns the server
/F This parameter is for compatibility.
When specified, the command functions in the same way when no parameter is specified.

Return Value 0 Success
1 The status of the server is not “Suspension (isolated).”
8 The EXPRESSCLUSTER Server service is not running.
9 The parameter is invalid.

Remarks This command can be specified only outside scripts.
When the server did not shut down normally, the status of the server becomes “Suspension (isolated)” at the next server startup. On the server of that status, activating a group is prohibited. Activating a group becomes possible after returning the server to the normal status by this command.

Permitting an access to the mirror disk (mdopen command)

mdopen.exe: the `mdopen.exe` command permits an access to the mirror disk.

Command line:

```
mdopen.exe mirrordisk_alias
```

Description	Normally, the mirror disk is accessible only when the resource is activated. In other cases the access is prohibited. This command permits the access to the inactivated mirror disk.								
Parameter	<i>mirrordisk_alias</i> Specifies the mirror disk resource name to which you want to permit the access.								
Return Value	<table><tr><td>0</td><td>Success</td></tr><tr><td>1</td><td>The parameter is invalid.</td></tr><tr><td>2</td><td>The mirroring is in progress. The access cannot be permitted.</td></tr><tr><td>3 or larger</td><td>Other error (possible causes are described below)<ul style="list-style-type: none">• The Replicator/Replicator DR is not used.• There is a task accessing the target mirror disk resource.• Internal error</td></tr></table>	0	Success	1	The parameter is invalid.	2	The mirroring is in progress. The access cannot be permitted.	3 or larger	Other error (possible causes are described below) <ul style="list-style-type: none">• The Replicator/Replicator DR is not used.• There is a task accessing the target mirror disk resource.• Internal error
0	Success								
1	The parameter is invalid.								
2	The mirroring is in progress. The access cannot be permitted.								
3 or larger	Other error (possible causes are described below) <ul style="list-style-type: none">• The Replicator/Replicator DR is not used.• There is a task accessing the target mirror disk resource.• Internal error								
Notes	When accessing the mirror disk is permitted by using this command, be sure to prohibit the access using the <code>mdclose</code> command before recovering the mirror.								
Remarks	This command can be specified only outside scripts. This command is available only when the Replicator/Replicator DR is used. This command is for executing the snapshot backup by a batch processing. For details on the snapshot backup, see “Performing a snapshot backup” in Chapter 10, “The system maintenance information” in this guide.								

Prohibiting an access to the mirror disk (mdclose command)

mdclose.exe: the `mdclose.exe` command prohibits an access to the mirror disk.

Command line:

```
mdclose.exe mirrordisk_alias
```

Description	<p>This command prohibits the access to the mirror disk that is permitted by the <code>mdopen</code> command.</p> <p>Do not run this command when there is no task accessing the specified mirror disk resource.</p>						
Parameter	<p><i>mirrordisk_alias</i> Specifies the name of a mirror disk resource to which you want to prohibit the access.</p>						
Return Value	<table> <tr> <td style="vertical-align: top;">0</td> <td>Success</td> </tr> <tr> <td style="vertical-align: top;">1</td> <td>The parameter is invalid.</td> </tr> <tr> <td style="vertical-align: top;">2 or larger</td> <td> Other error (possible causes are described below) <ul style="list-style-type: none"> • The Replicator/Replicator DR is not used. • There is a task accessing the target mirror disk resource. • Internal error </td> </tr> </table>	0	Success	1	The parameter is invalid.	2 or larger	Other error (possible causes are described below) <ul style="list-style-type: none"> • The Replicator/Replicator DR is not used. • There is a task accessing the target mirror disk resource. • Internal error
0	Success						
1	The parameter is invalid.						
2 or larger	Other error (possible causes are described below) <ul style="list-style-type: none"> • The Replicator/Replicator DR is not used. • There is a task accessing the target mirror disk resource. • Internal error 						
Notes	<p>When accessing the mirror disk is permitted using the <code>mdopen</code> command, be sure to prohibit the access using this command before recovering the mirror.</p>						
Remarks	<p>This command can be specified only outside scripts.</p> <p>This command is available only when the Replicator/Replicator DR is used.</p> <p>This command is for executing the snapshot backup by a batch processing. For details on the snapshot backup, see “Performing a snapshot backup” in Chapter 10, “The system maintenance information” in this guide.</p>						

Permitting an access to the shared disk (`sdopen` command)

`sdopen.exe`: the `sdopen.exe` command permits an access to the shared disk

Command line:

```
sdopen.exe    disk_resource_name
```

Description	In general, the shared disk is accessible only when the disk resource is activated. In other cases the access is prohibited. This command permits the access to the inactivated disk resource.
Parameter	<i>disk_resource_name</i> Specifies the disk resource name to which you want to permit the access.
Return Value	0 Success 1 The parameter is invalid. 3 or larger Other error (possible causes are described below) <ul style="list-style-type: none">• Invalid HBA settings• Invalid drive letter settings• Internal error
Notes	Make sure that the disk resource is inactivated before using this command. If this command is executed in the state that the disk resource is activated, data on the shared disk may be corrupted. When access to the shared disk is permitted by using this command, be sure to prohibit the access by using the <code>sdclose</code> command before activating the disk resource. If the disk resource is activated in the state where the access is not prohibited, data on the shared disk may be corrupted.
Remarks	This command can be used only outside scripts.

Prohibiting an access to the shared disk (sdclose command)

sdclose.exe: the `sdclose` command prohibits an access to the shared disk

Command line:

```
sdclose.exe disk_resource_name
```

Description This command prohibits accesses to the disk resource that are permitted by the `sdopen` command.

Parameter *disk_resource_name* Specifies the disk resource name to which you want to prohibit the access.

Return Value

0	Success
1	The parameter is invalid.
3 or larger	Other error (possible causes are described below) <ul style="list-style-type: none"> • Invalid HBA settings • Internal error

Notes When accessing the disk resource is permitted by using the `sdopen` command, be sure to prohibit the access by using this command before activating the disk resource.

Remarks This command can be used only outside scripts.

Error messages of the compatible commands

Message	Description	Solution
armbroadcast succeeded.	armbroadcast succeeded.	-
armbroadcast has received an invalid parameter.	armbroadcast received an invalid parameter.	Specify the valid input parameter.
armbroadcast failed in the internal processes (1%03d). The error code is 0x%x.	armbroadcast T failed in the internal processing.	Check if the memory is sufficient and/or OS is stable.
Cannot execute armbroadcast.	armbroadcast cannot be executed.	armbroadcast cannot be used when the arms_event of the start script is in the recover status. This is because the server is recovering the cluster.
armcall succeeded. command name=%s.	armcall succeeded.	-
armcall has received an invalid parameter.	armcall received an invalid parameter.	Specify an valid input parameter.
armcall failed to lock the file.	armcall failed to acquire the privilege to write lock for exclusive access control.	Check if the memory is sufficient and/or OS is stable.
armcall received a console close signal. The server will be shut down.	The server was shut down because the armcall console window was closed by a user's request.	-
armcall failed in the internal processes ("%03d"). The error code is 0x%x.	armcall failed in the internal processing.	Check if the memory is sufficient and/or OS is stable.
armcall failed to execute the command line. The error code is 0x%x.	Execution of exec-name specified in the command line of armcall failed.	Check if the valid values are specified for the path name, file name and parameter-n in the command lines.
armdown succeeded. option=%s.	armdown succeeded.	-
armdown has received an invalid parameter. option=%s.	armdown received an invalid parameter.	Specify an valid input parameter.
armdown shuts down the server. option=%s.	armdown started a server shutdown.	-
armdown cannot execute specified action. option=%s	armdown cannot be executed.	The server may have failed. Check it.
armdown failed in the internal processes (%03d). The error code is 0x%x.option=%s	armdown failed in the internal processing.	Check if the memory is sufficient and/or OS is stable.
armem succeeded. mode=%s.	armem succeeded.	-
armem has received an invalid parameter.	armem received an invalid parameter.	Specify a valid input parameter.
armem failed in the internal processes (%04d). The error code is 0x%x.option=%s	armem failed in the internal process.	Check if the memory is sufficient and/or OS is stable.
armforver succeeded. option=%s group-name=%s	armforver succeeded.	-
armforver has received an invalid parameter. option=%s group-name=%s	armforver received an invalid parameter.	Specify a valid input parameter.
Cannot execute armforver . option=%s group-name=%s	armforver cannot be executed.	Check if the failover group is being stopped or is already stopped.

Message	Description	Solution
armfover failed in the internal processes (1%03d). The error code is 0x%x.option=%s.group-name=%s.	armfover failed in the internal process.	Check if the memory is sufficient and/or OS is stable.
armgetcd succeeded.	armgetcd succeeded.	-
armgetcd has received an invalid parameter.	armgetcd received an invalid parameter.	Specify a valid input parameter.
armgetcd received a console close signal. The server will be shut down.	The server was shut down. This is because the console window of armgetcd was closed by a user's request.	-
armgetcd failed in the internal processes ("%03d"). The error code is 0x%x.	armgetcd failed in the internal process.	Check if the memory is sufficient and/or OS is stable.
armgstrt succeeded. group-name=%s.server-name=%s.	armgstrt succeeded.	-
armgstrt has received an invalid parameter.group-name=%s.server-name=%s.	armgstrt received an invalid parameter.	Specify a valid input parameter.
armgstrt failed in the internal processes (1%03d). The error code is 0x%x.group-name=%s.server-name=%s.	armgstrt failed in the internal process.	Check if the memory is sufficient and/or OS is stable.
armgstrt cannot execute the specified operation. group-name=%s server=%s	armgstart is not in the status to execute the specified operation.	The failover group is being started or it has been started, or the server may not be operating successfully. Check them.
armgstop succeeded. group-name=%s	armgstop succeeded.	-
armgstop has received an invalid parameter. group-name=%s	armgstop received an invalid parameter.	Specify a valid input parameter.
armgwait succeeded.	armgwait succeeded.	-
armgwait has received an invalid parameter.	armgwait received an invalid parameter.	Specify a valid input parameter.
armgwait timed out.	armgwait timed out.	Check the target failover group name.
armgwait failed to run the internal processes (1%03d). The error code is 0x%x.	armgwait failed in the internal process.	Check if the memory is sufficient and/or OS is stable.
armkill (WID="%0.16s") succeeded.	armkill succeeded.	-
armkill has received invalid WID ("%0.10s") as a parameter.	armload is not executed by the specified WID.	Check the command line (watcID) of the armload.
armkill has received an invalid parameter.	armkill received an invalid parameter.	Specify a valid input parameter.
armkill (WID="%0.16s") forcefully terminated application.	The application was forcefully terminated because it did not end within a designated time period.	Examine the application to find why it did not terminate within the designated time period.
armkill (WID="%0.16s") could not forcefully terminated application.	The application was forcefully terminated, because it did not end within a designated time period. However the forced termination failed.	Same as above
armkill (WID="%0.16s") could not stop the service.	The service did not end within the specified time period.	Examine the service to find why it did not end within the specified time period.

Message	Description	Solution
armkill (WID="%0.16s") has failed in the internal processes (3%03d). The error code is 0x%x.	armkill failed in the internal process.	When the "internal process" is 3060, the application is already closed. Examine the application to find why it ended. If not above, check if the memory is sufficient and/or OS is stable.
armkill (WID="%0.32s") failed to stop the service. Detailed information:%0.160s	armkill failed to stop the service.	The request to stop the service that was asked to the service control manager failed. Investigation needs to be conducted in the service.
armload (WID="%0.16s") succeeded.	armload succeeded.	-
armload has received invalid WID ("%0.16s") as an invalid parameter.	WID is overlapped.	Specify a unique WID.
armload has received an invalid parameter.	armload received an invalid parameter.	Specify an valid input parameter.
armload (WID="%0.16s") has reached the maximum number of processes that can be run simultaneously.	An attempt to start up applications/services more than executable number of applications/servers (256) was made	Create scripts to make the number of running applications/ services within 256.
armload has received WID ("%0.16s") that exceeds the maximum character count as a parameter.	The character string of WID has more than 256 characters	Make the character string of WID to have up to 255 characters.
armload(WID="%0.16s") detected the service starting time-out.	The service did not end within a designated time period.	Examine the service to find why it did not end within the designated time period.
armload (WID="%0.16s") failed in the internal processes(1%03d). The error code is 0x%x.	armload failed in the internal processes.	Check if the memory is sufficient and/or OS is stable.
armpoll has received an invalid parameter.	Command monitoring process received an invalid parameter.	Check if the memory is sufficient and/or OS is stable.
armpoll (WID="%0.16s") detected extinction of the application. The stop code is %d.	Command monitor process did not detect any application.	Detected an application termination. Examine the application to find why it ended.
armload (WID="%0.16s") couldn't log on to user ("%0.32s"). The error code is 0x%x.	Failed to log on to the user account.	Check user account registration information (user ID, password), and if the domain name is indicated, also check the domain name in NEC EXPRESSCLUSTER manager.
armload (WID="%0.16s") failed to execute the command line. The error code is 0x%x.	Failed to start the application.	Check if the valid path name and file name are specified in the exec-name of the armload command line. Check if a valid value is specified to the parameter-n.
armload (WID="%0.16s") could not log on to user ("%0.32s"). The error code is 0x%x.	Failed to acquire a password of a user account.	Check if the user account registration is done in NEC EXPRESSCLUSTER manager .
armload (WID="%0.16s") could not log on to user ("%0.32s"). The error code is 0x%x.	Command monitoring process failed in internal processing.	Check if the memory is sufficient and/or OS is stable.
Command monitor process (WID="%0.16s") detected a failure in the services. The stop code is %d & %d.	Command monitor process detected a failure of the service.	Detected service termination. Examine the service to find it terminated.

Message	Description	Solution
Command monitor process (WID="%0.16s") failed to get the environmental variable name.	Command monitor process failed in acquiring an environmental variable name.	It may have been started from outside of the scripts Start from outside of script is not supported. If not above, check if memory is sufficient, and/or OS is stable.
Command monitor process (WID="%0.16s") restarted script.	Command monitor process restarted scripts.	Due to detection of application/service termination, the scripts restarted.
Command monitor process (WID="%0.16s") restarted application.	Command monitor process restarted the application.	Due to detection of termination of the application, the application restarted.
Command monitor process (WID="%0.16s") restarted Service	Command monitor process restarted the service	Due to detection of termination of the service, the restarted.
Command monitor process (WID="%0.16s") completed the failover of the group ("%0.10s").	Command monitor process performed a failover to the group.	Due to detection of application/service termination, the failover group failed over.
Command monitor process (WID="%0.16s") shut down the server.	Command monitor process shut down the server.	Due to detection of application/service termination, the server shut down.
armpoll (WID="%0.16s") has received an invalid service name ("%0.10s") as a parameter.	armpoll received an invalid service name as a parameter.	In the armpoll command line, check if the valid service name is specified for service-name. Check if the valid value is designated for parameter-n as well.
armpoll (WID="%0.16s") failed to get user ("%0.32s") information. The user name may be incorrect. The error code is 0x%x.	Failed to acquire a domain name from the user name.	Check if the user name is registered in the system.
armpoll (WID="%0.16s") detected extinction of the application.	Command monitor process did not detect any application (Failed to acquire the application termination code of the application).	Detected termination of an application. Examine the application to find why it terminated.
armpoll (WID="%0.16s") failed to start the service. The error code is 0x%x.	Failed to start the service.	Examine the service to find why it failed to start.
Command monitor process (WID="%0.16s") failed to fail over the group(%s). The error code is 0x%x.	Command monitor process failed to failover the group.	Check if the failover destination server is operating successfully as a cluster.
Command monitor process (WID="%0.32s") failed to stop the service. Detailed information:%0.160s	Command monitor process failed to stop the service.	The service stop request for the service control manager failed. Examine the service.
Command monitor process (WID="%0.16s") forcefully terminated the application.	Command monitor process forced to finish the application.	The application was forcefully terminated by TerminateProcess() because it could not end within the specified time period. Check the application.
Command monitor process (WID="%0.16s") failed to forcefully terminate the application.	Command monitor process failed to finish the application.	The application could not end within the specified time period due to the WM_CLOSE message. An attempt to forcefully terminate by the TerminateProcess() was made. However it did not end. Check the application.

Message	Description	Solution
Command monitor process (WID="%0.16s") failed to stop Service.	Command monitor process failed to stop Service.	Service did not end within the specified time period. Check the Service.
armloadc succeeded. WatchID=%0.16s.mode=%s.time=%s.	armloadc succeeded.	-
armloadc received an invalid parameter. WatchID=%0.16s.mode=%s.time=%s.	armloadc received an invalid parameter.	Specify a valid input parameter.
Cannot execute armloadc. WatchID=%0.16s.mode=%s.time=%s.	armloadc cannot be executed.	Check "startup state" and "monitoring state" by NEC EXPRESSCLUSTER task manager. Check whether or not armloadc can be executed by referring to application/service specification matrix of command reference (armloadc).
armloadc detected time-out while waiting to start/stop the application/service. WatchID=%0.16s mode=%s time=%s	Application/service did not end within the designated time period.	Examine the application/service to find why it did not end within the designated time period.
armloadc Win32API error.WatchID=%0.16s.mode=%s.time=%s.	armloadc failed in the internal processing.	Check if the memory is sufficient and/or OS is unstable.
armmode succeeded. option=%s.	armmode succeeded.	-
armloadc received an invalid parameter. WatchID=%0.16s.mode=%s.time=%s.	armloadc received an invalid parameter.	Specify a valid input parameter.
armmode cannot execute the specified action (%03d). option=%s.	armmode cannot execute the specified operation.	Force-return (/F) :
		Some servers are not isolated. Check the servers.
		Server isolation (/I) :
		The local server is not operating successfully in the cluster. Or there are no two or more servers that are working successfully in the cluster. Check the servers.
		Server isolation (/I) :
		The local server is not operating successfully in the cluster. Check the server.
armmode failed in the internal processes(%03d).The error code is 0x%x.option=%s.	armmode failed in the internal processing.	Check if the memory is sufficient and/or OS is stable.
armnsadd succeeded (share=%0.80s,path=%0.80s).	armnsadd succeeded.	-
armnsadd has received an invalid parameter.	armnsadd received an invalid parameter.	Specify a valid input parameter.
armnsadd failed to run the internal processes (1%03d). The error code is 0x%x.	armnsadd failed in the internal processing.	If the internal process is 1020, the shared name has more than 80 characters. Specify it within 80 characters.

Message	Description	Solution
		If the internal process is 1040, the path name is invalid. Check the path name.
		If the internal process is 1050, the shared name is invalid. Check if you did not use characters that cannot be specified for shared names.
		If the internal process is 1060, you do not have the privilege to access the path name. Check the access privilege.
		If the internal process is 1090, the same name is already used. Specify a shared name that does not overlap with others.
		If not above, check if the memory is sufficient, and/or OS is stable.
armnsdel succeeded (share=%s).	armnsdel succeeded.	-
armnsdel has received an invalid parameter.	armnsdel received an invalid parameter.	Specify a valid input parameter.
armnsdel failed to run the internal processes (%d). The error code is 0x%x.	armnsdel failed in the internal processing.	If the internal process is 1030, you do not have the privilege to access the shared name. Check the access privilege.
		If the internal process is 1060, the shared name cannot be found. Check the name.
		If not above, check if the memory is sufficient, or OS is stable.
armpause succeeded.	armpause succeeded.	-
armpause has received an invalid parameter.	armpause received an invalid parameter.	Specify a valid input parameter.
armpause cannot display the message.	armpause cannot display dialog messages.	Check if the memory is sufficient and/or OS is stable.
armsetcd succeeded.	armsetcd succeeded.	-
armsetcd has received an invalid parameter.	armsetcd received an invalid parameter.	Specify a valid input parameter.
armsetcd received a console close signal. The server will be shut down.	server shutdown was executed because armsetcd console window was closed by user's request.	-
armsetcd failed in the internal processes ("%d"). The error code is 0x%x.	armsetcd failed in the internal processing.	Check if the memory is sufficient And/or OS is stable.
armsleep succeeded.	armsleep succeeded.	-
armsleep has received an invalid parameter.	armsleep received an invalid parameter.	Specify a valid input parameter.
armstdn failed in the internal processes(%d).The error code is 0x%x.option=%s.	armstdn failed in the internal processing.	Check if the memory is sufficient and/or OS is stable.
armstdn succeeded. cmd=%s	armstdn succeeded.	-
Failed to shut down the cluster. The server is not operating as a cluster.	Failed to acquire a cluster name.	The server is not operating as cluster. Check it.

Message	Description	Solution
Failed to shut down the cluster. The error code is 0x%x.	armwhshr failed in internal processing.	Check if the memory is sufficient and/or OS is stable.
Failed to shut down the cluster. EXPRESSCLUSTER Server Service is not started.	"The EXPRESSCLUSTER Server" service is not started.	"The EXPRESSCLUSTER Server" service is not started. Check it.
armwhshr has received an invalid parameter.	armwhshr received an invalid parameter.	Specify a valid input parameter.
armwhshr failed in the internal processes(1%03d). The error code is 0x%x.	armwhshr failed in the internal processing.	Check if the memory is sufficient and/or OS is stable.
armwhshr detected connection error to share-name(%s). The error code is 0x%x.	armwhshr detected error in connection to the shared name.	The shared name cannot be used. Recover devices that are associated to the shared name.
		1.OS is unstable. Check it.
		2. Make sure that power is supplied to the devices. 3. Make sure that the devices and the servers are connected properly.
armwhshr detected connection recovery to shared name(%s). The error code is 0x%x.	armwhshr detected recovery of connection to the shared name.	-
mdopen failed. An internal error occurred.	mdopen failed. An internal error occurred.	Check if the memory is sufficient and/or OS is stable.
mdopen failed. The resource is busy.	mdopen failed. The resource is busy.	The partition may be being used. Retry later.
mdopen failed. A network error occurred.	mdopen failed. A network error occurred.	Check how the interconnect is connected.
mdopen failed. Cannot establish the mirror disk connection.	mdopen failed to establish the communication of the mirror disk.	Check if the cluster configuration data is valid.
mdopen failed. The resource name is invalid.	mdopen failed. The resource name is invalid.	Check if the cluster configuration data is valid.
mdopen failed. The status is invalid.	mdopen failed. The status is invalid.	Mirror recovery is required.
mdopen failed. The resource is not initialized.	mdopen failed. The resource is not initialized.	Check if the partition is allocated , the disk is recognized by OS and the cluster configuration data is correct.
mdopen failed. The resource is not performed first mirror construction.	mdopen failed. Initial mirror construction is not done for resources.	Initial mirror construction is required.
mdopen failed. Cannot lock the mirror disk.	mdopen failed to lock the mirror disk.	Check if the memory is sufficient and/or OS is stable.
mdopen failed. The license is not registered.	mdopen failed. The license is not registered.	Register the license.
mdopen failed. The trial version has expired.	mdopen failed. The trial version has expired.	Register the license.
mdopen failed. The license authentication failed.	mdopen failed. The license authentication failed.	Register the license.
mdopen failed. Cannot find the history folder.	mdopen failed. The history folder cannot be found.	Check if the cluster configuration data is correct.
mdopen failed. The mirror connect is not initialized.	mdopen failed. The mirror connect is not initialized.	Check the connection status of the mirror connect. Check if the cluster configuration data is correct.

Message	Description	Solution
mdopen failed. Cannot find the partition specified for the cluster partition.	mdopen failed. The partition specified for the cluster partition cannot be found.	Check if the partition is allocated and the disk is recognized by OS.
mdopen failed. Cannot find the partition specified for the data partition.	mdopen failed. The partition specified for the data partition cannot be found.	Check if the partition is allocated and the disk is recognized by OS.
mdopen failed. Cannot change the drive letter for the cluster partition.	mdopen failed. The drive letter for the cluster partition could not be changed.	Check the specification of the drive letter of the cluster configuration data. Make sure that the drive letter is not used by any other partitions.
mdopen failed. Cannot change the drive letter for the data partition.	mdopen failed. The drive letter for the data partition could not be changed.	Check the specification of the drive letter of the cluster configuration data. Make sure that the drive letter is not used by any other partitions.
mdopen failed. The server name is invalid.	mdopen failed. The server name is invalid.	Check if the cluster configuration data is correct.
mdopen has received an invalid parameter.	mdopen received an invalid parameter.	Specify a valid input parameter.
mdopen failed in the internal processes(%2). The error code is %3.	mdopen failed in the internal processing.	Check if the memory is sufficient and/or OS is stable.
mdopen succeeded. The mirror disk resource is %2.	mdopen succeeded.	-
mdclose failed. An internal error occurred.	mdclose failed. An internal error occurred.	Check if the memory is sufficient and/or OS is stable.
mdclose failed. The resource is busy.	mdclose failed. The resource is busy.	Retry it later.
mdclose failed. A network error occurred.	mdclose failed. A network error occurred.	Check the connection status of the interconnect.
mdclose failed. Cannot establish the mirror disk connection.	mdclose failed to establish the mirror disk connection.	Check if the cluster configuration data is correct.
mdclose failed. The resource name is invalid.	mdclose failed. The resource name is invalid.	Check if the cluster configuration data is correct.
mdclose failed. The status is invalid.	mdclose failed. The status is invalid.	Mirror recovery is required.
mdclose failed. The resource is not initialized.	mdclose failed. The resource is not initialized.	Check if the partition is allocated, if the disk is identified by OS and if the cluster configuration data is correct.
mdclose failed. The resource has not performed initial mirror construction.	mdclose failed. The initial mirror construction has not been done for the resource.	Initial mirror construction is required.
mdclose failed. Cannot lock the mirror disk.	mdclose failed to lock the mirror disk.	Check if the memory is sufficient and/or OS is stable.
mdclose failed. The license is not registered.	mdclose failed. The license is not registered.	Register the license.
mdclose failed. The trial version has expired.	mdclose failed. The trial version has expired.	Register the license.
mdclose failed. The license authentication failed.	mdclose failed. The license authentication failed.	Register the license.
mdclose failed. Cannot find the history folder.	mdclose failed to find the history folder.	Check if the cluster configuration data is correct.

Message	Description	Solution
mdclose failed. The mirror connect is not initialized.	mdclose failed. The mirror connect is not initialized.	Check the connection status of the mirror connect. Check if the cluster configuration data is correct.
mdclose failed. Cannot find the partition specified for the cluster partition.	mdclose failed to find the partition specified for the cluster partition.	Check if the partition is allocated and if the disk is identified by OS.
mdclose failed. Cannot find the partition specified for the data partition.	mdclose failed to find the partition specified for the data partition.	Check if the partition is allocated and if the disk is identified by OS.
mdclose has received an invalid parameter.	mdclose received an invalid parameter.	Specify a valid input parameter.
mdclose failed in the internal processes(%2). The error code is %3.	mdclose failed in the internal processing.	Check if the memory is sufficient and OS is stable.
mdclose succeeded. The mirror disk resource is %2.	mdclose succeeded.	-
sdopen succeeded. (%2)	sdopen succeeded.	-
sdopen failed. Internal error occurred. (%1)	sdopen failed. Internal error occurred.	Check if the memory and/or the resource of OS are sufficient.
sdopen failed. Failed to load cluster configuration data. (%1)	sdopen failed to load cluster configuration data.	Check if the cluster configuration data exists in the place it should be.
sdopen failed. Failed to unload cluster configuration data. (%1)	sdopen failed to unload cluster configuration data.	Check if the cluster configuration data exists in the place it should be.
sdopen failed. Failed to get cluster configuration data. (%1)	sdopen failed to acquire the cluster configuration data.	Check if the cluster configuration data is correct.
sdopen failed. Failed to allocate memory. (%1)	sdopen failed to allocate memory.	Check if the memory and/or the resource of OS are sufficient.
sdopen failed. Failed to activate resource. (%1)	sdopen failed to activate resource.	Check if the setting of HBA is correct. The partition may be being used. Check it.
sdopen failed. Failed to create thread. (%1)	sdopen failed to create thread.	Check if the memory and/or the resource of OS are sufficient.
sdopen failed. Timeout occurred on thread. (%1)	sdopen failed. Timeout occurred on thread.	Check if the memory and/or the resource of OS are sufficient.
sdopen failed. Failed to dismount the partition specified by the resource. (%1)	sdopen failed to dismount the partition specified by the resource.	The partition may be being used. Check it.
sdopen failed. Failed to lock the partition specified by the resource. (%1)	sdopen failed to lock the partition specified by the resource	The partition may be being used. Check it.
sdopen failed. Server does not exist in cluster configuration data. (%1)	sdopen failed. The server does not exist in cluster configuration data.	Check if the server exists in the cluster configuration data.
sdopen failed. Resource does not exist in cluster configuration data. (%1)	sdopen failed. The resource does not exist in cluster configuration data.	Check if the resource exists in the cluster configuration data.
sdopen failed. Cannot find the specified partition. (%1)	sdopen failed to find the specified partition.	Check if the specified partition is recognized by OS.
sdopen failed. Cannot change the drive letter. (%1)	sdopen failed to change the drive letter.	Check if the specified drive letter is not used in other partitions.
sdclose succeeded. (%2)	sdclose succeeded.	-
sdclose failed. Internal error occurred. (%1)	sdclose failed. Internal error occurred.	Check if the memory and/or the resource of OS are sufficient.

Message	Description	Solution
sdclose failed. Failed to load cluster configuration data. (%1)	sdclose failed to load cluster configuration data.	Check if the cluster configuration data exists in the place it should be.
sdclose failed. Failed to unload cluster configuration data. (%1)	sdclose failed to unload cluster configuration data.	Check if the cluster configuration data exists in the place it should be.
sdclose failed. Failed to get cluster configuration data. (%1)	sdclose failed to acquire the cluster configuration data.	Check if the cluster configuration data is correct.
sdclose failed. Failed to allocate memory. (%1)	sdclose failed to allocate memory.	Check if the memory and/or the resource of OS are sufficient.
sdclose failed. Failed to deactivate resource. (%1)	sdclose failed to deactivate resource.	Check if the setting of HBA is correct.
sdclose failed. Failed to create thread. (%1)	sdclose failed to create thread.	Check if the memory and/or the resource of OS are sufficient.
sdclose failed. Timeout occurred on thread. (%1)	sdclose failed. Timeout occurred on thread.	Check if the memory and/or the resource of OS are sufficient.
sdclose failed. Failed to dismount the partition specified by the resource. (%1)	sdclose failed to dismount the partition specified by the resource.	The partition may be being used. Check it.
sdclose failed. Failed to lock the partition specified by the resource. (%1)	sdclose failed to lock the partition specified by the resource.	The partition may be being used. Check it.
sdclose failed. Server does not exist in cluster configuration data. (%1))	sdclose failed. Server does not exist in cluster configuration data.	Check if the server exists in the cluster configuration.
sdclose failed. Resource does not exist in cluster configuration data. (%1)	sdclose failed. The resource does not exist in cluster configuration data.	Check if the resource exists in the cluster configuration.
sdclose failed. Cannot find the specified partition. (%1)	sdclose failed to find the specified partition.	Check if the specified partition is recognized by OS.

Section II Resource details

This section provides detailed information on the resources that constitute a cluster.

- Chapter 5 Group resource details
- Chapter 6 Monitor resource details
- Chapter 7 Heartbeat resources
- Chapter 8 Details on network partition resolution resources
- Chapter 9 Other monitor settings

Chapter 5 Group resource details

This chapter provides information on group resources that constitute a failover group. For overview of group resources, see Chapter 2, “Design a system configuration” in the *Installation and Configuration Guide*.

This chapter covers:

- Group resources..... 520
- What is a group?..... 521
- Displaying and changing the settings of group properties..... 546
- Displaying and changing the settings of group resources..... 561
- Understanding server groups 572
- Displaying and changing the server group settings 573
- Understanding application resources 576
- Understanding floating IP resources..... 585
- Understanding mirror disk resources..... 592
- Understanding registry synchronization resources 610
- Understanding script resources..... 616
- Understanding disk resources 650
- Understanding service resources 655
- Understanding print spooler resources 661
- Understanding virtual computer name resources..... 666
- Understanding dynamic DNS resources 675
- Understanding virtual IP resources..... 682
- Understanding CIFS resources 696
- Understanding NAS resources..... 705
- Understanding hybrid disk resources 709
- Understanding VM resources 718
- Understanding AWS elastic ip resources 723
- Understanding AWS virtual ip resources 729
- Understanding Azure probe port resources 735

Group resources

Currently supported group resources are as follows:

Group resource name	Abbreviation	Functional overview
Application resources	appli	Refer to “Understanding application resources” on page 576.
Floating IP resources	fip	Refer to “Understanding floating IP resources” on page 585.
Mirror disk resources	md	Refer to “Understanding mirror disk resources” on page 592.
Registry synchronization resources	regsync	Refer to “Understanding registry synchronization resources” on page 608.
Script resources	script	Refer to “Understanding script resources” on page 616.
Disk resources	sd	Refer to “Understanding disk resources” on page 650.
Service resources	service	Refer to “Understanding service resources” on page 655.
Print spooler resources	spool	Refer to “Understanding print spooler resources” on page 661.
Virtual computer name resources	vcom	Refer to “Understanding virtual computer name resources” on page 666.
Dynamic DNS resources	ddns	Refer to “Understanding dynamic DNS resources” on page 675.
Virtual IP resources	vip	Refer to “Understanding virtual IP resources” on page 682.
CIFS resources	cifs	Refer to “Understanding CIFS resources” on page 696.
NAS resources	nas	Refer to “Understanding NAS resources” on page 705.
Hybrid disk resource	hd	Refer to “Understanding hybrid disk resources” on page 709.
VM resource	vm	Refer to “Understanding VM resources” on page 718.
AWS elastic ip resource	awseip	Refer to “Understanding AWS elastic ip resources” on page 723.
AWS elastic ip resource	awsvip	Refer to “Understanding AWS virtual ip resources” on page 729.
Azure probe port resource	azurepp	Refer to “Understanding Azure probe port resources” on page 735.

What is a group?

A group is a unit to perform a failover. Rules regarding to operations at failover (failover policies) can be set per group.

Understanding the group types

Groups fall into two types: virtual machine groups and failover groups.

- **Virtual machine group**

Performs failover (migration) for each virtual machine. The following resources can be registered with this group: virtual machine resource, mirror disk resource, disk resource, hybrid disk resource, NAS resource, and script resource.

- **Failover group**

Collects the resources required for application continuation and performs failover for each application. Up to 256 group resources can be registered with each group. However, no virtual machine resource can be registered.

Understanding the group properties

The properties that can be set on each group are described below:

Servers that can run the Group

Select and set the servers that can run the group from the servers that configure a cluster. Specify the order of priority to the servers that can run the group for running the group.

Startup Attribute

Sets the startup attribute of a group to the auto startup or manual startup.

In the case of the auto startup, when a cluster is started, a group is started up automatically on the server that has the highest priority among the servers that can run the group.

In the case of the manual startup, a group is not started even when a server is started up. After starting the server, start up the group manually by using the WebManager or the clpgrp command. For details on the WebManager, see Chapter 1, “Functions of the WebManager” in this guide. For details on the clpgrp command, see “Operating groups (clpgrp command)” in Chapter 3, “EXPRESSCLUSTER command reference” in this guide.

Failover Exclusive Attribute

Sets the failover exclusive attribute of the group at failover. The following shows the failover exclusive attributes.

However, this attribute cannot be specified under the following conditions:

- If **Virtual machine group** is specified as the group type
- When failover attribute is one of **Fail over dynamically**, **Prioritize failover policy in the server group** or **Enable only manual failover among the server groups**.

The settable failover exclusive attributes are as follows:

Off

Exclusion is not performed at failover. Failover is performed on the server of the highest priority among the servers that can fail over.

Normal

Exclusion is performed at failover. Failover is performed on the server on which the other normal exclusion groups are not started and which is given the highest priority among the servers that can run the group.

However, if the other normal exclusion groups have already been started on all servers that the failover can be performed, exclusion is not performed. Failover is performed on the server that is given the highest priority among the servers on which failover can be performed.

Absolute

Exclusion is performed at failover. Failover is performed on the server on which the other normal exclusion groups are not started and which is given the highest priority among the servers that can run the group.

However, failover is not performed if the other absolute exclusion groups have already been started on all servers on which failover can be performed.

Note:

Exclusion is not performed to the normal and absolute exclusion groups. Normal exclusion is performed only among the normal exclusion groups. Absolute exclusion is performed only among the absolute exclusion groups. In either case, exclusion is not performed with the no-exclusion group. For details on the failover exclusive attribute, see “Understanding failover policy” (page 526).”

Failover Attribute

Specify the failover method. The following failover attributes can be specified.

Auto Failover

A heartbeat timeout or error detection by a group or monitor resource triggers an automatic failover. For an automatic failover, the following options can be specified.

- Use the startup server settings

When failover is executed due to the error detection of the group resource or monitor resource, the failover destination settings of the resource is used (stable server/ the server that has the highest priority). Also, when failing over is executed due to the timeout detection of the heartbeat, the failover destination is determined following the priority of the server set as servers that can run the group.

For the operation when a stable server or the server that has the highest priority is used, see “Displaying and changing the operation settings when a group resource error is detected” (page 565) and “Displaying and changing the settings when an error is detected by a monitor resource” (page 797).

• Fail over dynamically

The failover destination is determined by considering the statuses of each server's monitor resource or failover group, and then a failover is performed.

The failover destination is determined in the following way.

Determination factor	Condition		Result
Status of critical monitor resource	Error (all servers)		When there is no failover destination, proceed to forced failover judgment process.
	Normal (single server)		A normal server is used as the failover destination.
	Normal (multiple servers)		Proceed to the process that compares error levels.
Perform a forced failover	Set		Proceed to the process that ignores the status of the critical monitor resource and which compares error levels for all the activated servers.
	Not set		Failover is not performed.
Number of servers that have the lowest error level	1		The server with the lowest error level is used as the failover destination.
	Two or more		Proceed to the process that judges whether there is a server that can perform a failover in the server that has the lowest error level and that is in the same server group as the failover source.
Prioritize failover policy in the server group	Set	Within the same server group as the failover source, there is a server that can perform failover.	The server in the same server group is used as the failover destination.
		Within the same server group as the failover source, there is no server that can perform a failover.	Proceed to the smart failover judgment process.
	Not set		Proceed to the smart failover judgment process.
Perform a smart failover	Set	The number of servers recommended as the failover destination is 1.	The server recommended by the smart failover is used as the failover destination.
		The number of servers recommended as the failover destination is 2 or more.	Proceed to the operation level judgment process.
	Not set		Proceed to the operation level judgment process.
Number of servers with the lowest operation level	1		The server that has the lowest operation level is used as the failover destination.
	Two or more		The running server that has the highest priority is used as the failover destination.

Note:

Critical monitor resource

Exclude the server which is detecting the error by a monitor resource from the failover destination.

Exclude the monitor resources of the following types in internal version 11.10:

- IP monitor resource
- NIC link up/down monitor resource

Internal version 11.15 and later can set the exclusive monitor with the Builder.

Error level

This is the number of monitor resources that have detected errors.

Smart failover

A function that assigns the server with the smallest load as the failover destination, based on the system resource information collected by the System Resource Agent. To enable this function, a System Resource Agent license must be registered on all the servers set as the failover destination and the system monitor resource must be set as the monitor resource. For details on the system resource monitor, see “Understanding system monitor resources” in Chapter 6 “Monitor resource details” in this guide.

In the 11.10 internal version, the system load is calculated from the following values:

- CPU usage
- Memory usage

Operation level

This is the number of failover groups that have been started or are being started, excluding management group

- **Prioritize failover policy in the server group**

If a server in the same server group can be used as the failover destination, this server is preferably used. If no server in the same server group can be used as the failover destination, a server in another server group is used as the failover destination.

When failover is executed due to the error detection of the group resource or monitor resource, the failover destination settings of the resource is used (stable server/ the server that has the highest priority). Also, when failing over is executed due to the timeout detection of the heartbeat, the failover destination is determined following the priority of the server set as servers that can run the group.

- **Allow only a manual failover between server groups**

This can be selected only when the above **Prioritize failover policy in the server group** is set.

An automatic failover is performed only if a server within the same server group is the destination.

If no servers in the same server group can be used as the failover destination, failing over to a server in another server group is not automatically performed.

To move the group to a server in another server group, use the WebManager or clpgrp command.

Manual Failover

Failover is not automatically performed when a heartbeat is timed out. In that case, perform failover manually by using the WebManager or the clpgrp command. However, even if manual failover is specified, a failover is performed automatically when an error is detected by a group or monitor resource.

Note:

If **Execute Failover to outside the Server Group** is set in message receive monitor resource setting, dynamic failover setting and failover setting between server groups will be invalid. A failover is applied to the server that is in a server group other than the server group to which the failover source server belongs and which has the highest priority.

- Failback Attribute

Set either auto failback or manual failback. However, this cannot be specified when the following conditions match.

- Mirror disk resource or hybrid disk resource is set to fail over group.
- Failover attribute is **Fail over dynamically**.

In the case of the auto failback, failback will be automatically performed when the server that is given the highest priority is started after a failover.

In the case of the manual failback, a failback is not performed even if a server is started.

- Logical Service

Set the logical service name.

The logical service is the character string that is used as an identifier when using an application which identifies a group by using the compatible API of EXPRESSCLUSTER Ver8.0 or earlier.

Understanding failover policy

A failover policy is a rule that determines a server to be the failover destination from multiple servers, and it is defined by the properties of a group. When you configure the failover policy, avoid making certain servers more heavily loaded at a failover.

The following describes how servers behave differently depending on failover policies when a failover occurs using example of the server list that can fail over and failover priority in the list.

<Symbols and meaning>

Server status	Description
o	Normal (properly working as a cluster)
od	Suspended (not recovered as a cluster yet)
×	Stopped (cluster is stopped)

3-node configuration:

Group	Order of server priorities		
	1 st priority server	2 nd priority server	3 rd priority server
A	server1	server3	server2
B	server2	server3	server1

2-node configuration:

Group	Order of server priorities	
	1 st priority server	2 nd priority server
A	server1	server2
B	server2	server1

It is assumed that the group startup attributes are set to auto startup and the failback attributes are set to manual failback for both Group A and B. It is also assumed that the servers are configured not to recover automatically from the status of being suspended. Whether to perform auto recovery from the suspended status is set ON/OFF of **Auto Return** on the **Auto Recovery** tab in **Cluster Properties**.

- If groups of different failover exclusive attributes co-exist in a cluster, they do not interfere with each other. For example, a group of full exclusive attributes may start on a server where a group of non-exclusive attributes is active, and vice versa.
- For groups whose failover exclusive attributes are normal or full, the server which they start up or fail over is determined by the failover priority to the server. If a group has two or more servers of the same failover priority, it is determined by the order of numbers, the specific symbols and alphabets of the group name.
- The failover priority of the management group is determined by the server priority. You can specify server priority on the **Master Server** tab in **Cluster Properties**.

When the failover exclusive attribute of Group A and B is set to Off:

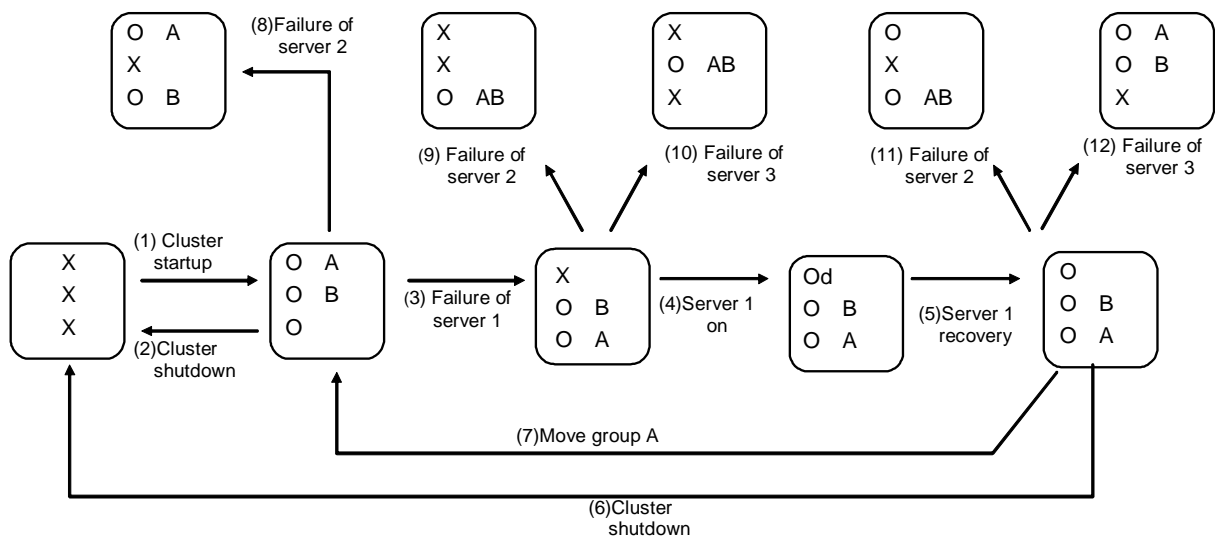
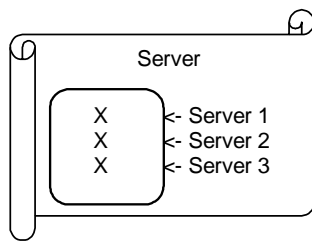

1. Cluster startup
2. Cluster shutdown
3. Failure of server1: Fails over to the next priority server.
4. Server1 power on
5. Server1 cluster recovery
6. Cluster shutdown
7. Move Group A
8. Failure of server2: Fails over to the next priority server.
9. Failure of server2: Fails over to the next priority server.
10. Failure of server3: Fails over to the next priority server
11. Failure of server2: Fails over to the next priority server.
12. Failure of server2: Fails over to the next priority server.

When the failover exclusive attribute for Group A and B is set to Normal:

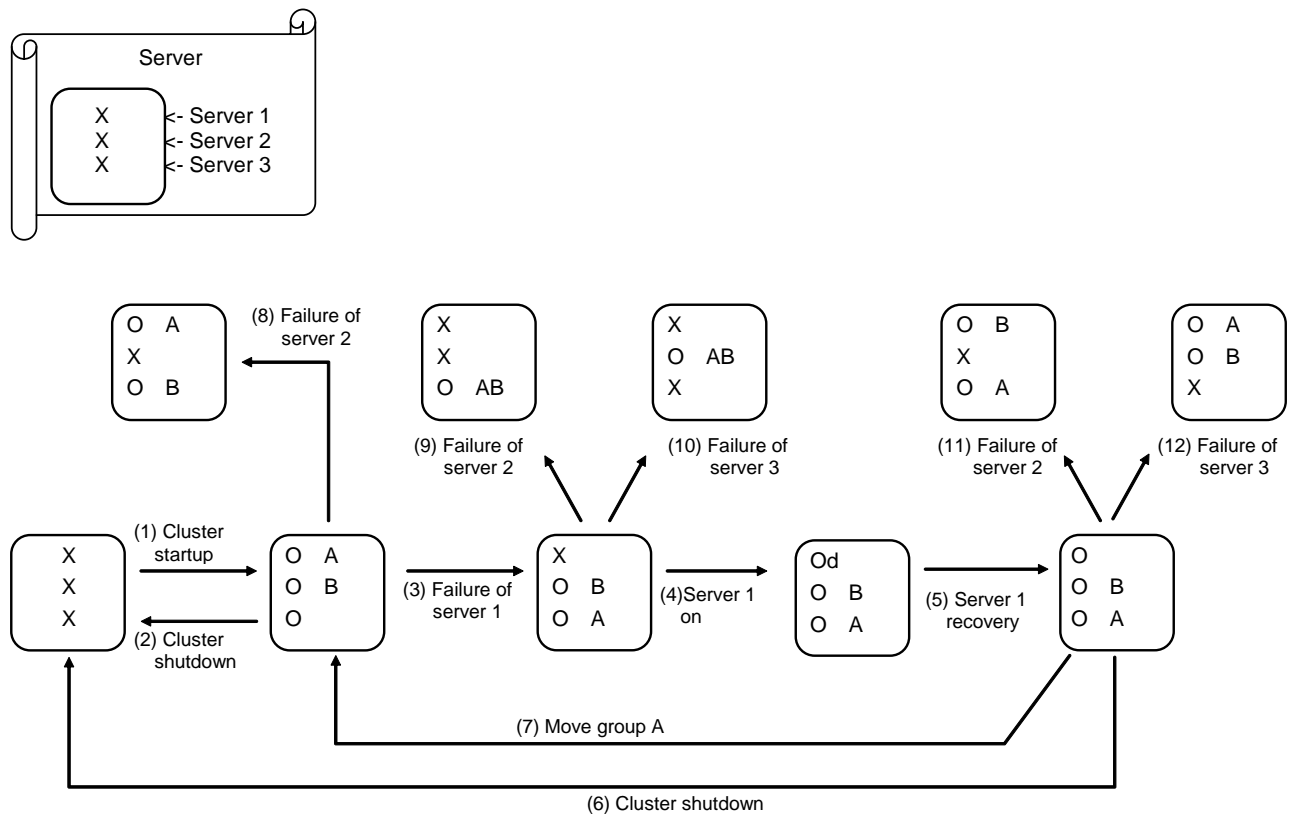

1. Cluster startup
2. Cluster shutdown
3. Failure of server1: Fails over to a server where no normal exclusive group is active.
4. Server1 power on
5. Server1 cluster recovery
6. Cluster shutdown
7. Move group A
8. Failure of server2: Fails over to a server where a normal exclusive group is not active.
9. Failure of server2: There is no server where a normal exclusive group is not active, but failover to the server because there is a server that can be started.
10. Failure of server3: There is no server where a normal exclusive group is not active, but failover to the server because there is a server that can be started.
11. Failure of server2: Fails over to a server where a normal exclusive group is not active.
12. Failure of server3: Fails over to a server where a normal exclusive group is not active.

When the failover exclusive attribute for Group A and B is set to Absolute:

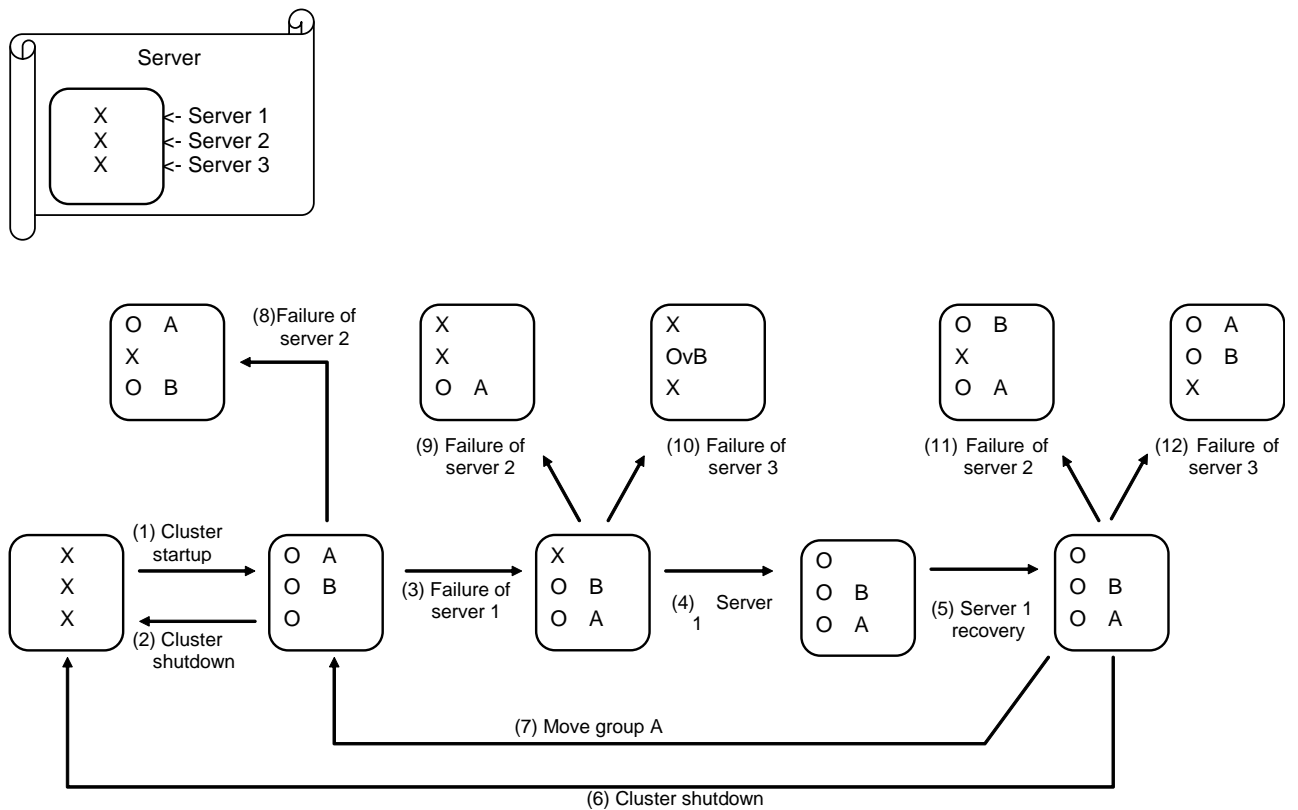

1. Cluster startup
2. Cluster shutdown
3. Failure of server1: Fails over to the next priority server.
4. Server1 power on
5. Server1 cluster recovery
6. Cluster shutdown
7. Move group A
8. Failure of server2: Fails over to the next priority server.
9. Failure of server2: Does not failover (Group B stops).
10. Failure of server3: Does not failover (Group A stops).
11. Failure of server2: Fails over to the server where no full exclusive group is active.
12. Failure of server3: Fails over to the server where no full exclusive group is active.

- For Replicator - (two-server configuration)

When the failover exclusive attribute for Group A and B is set to Off:

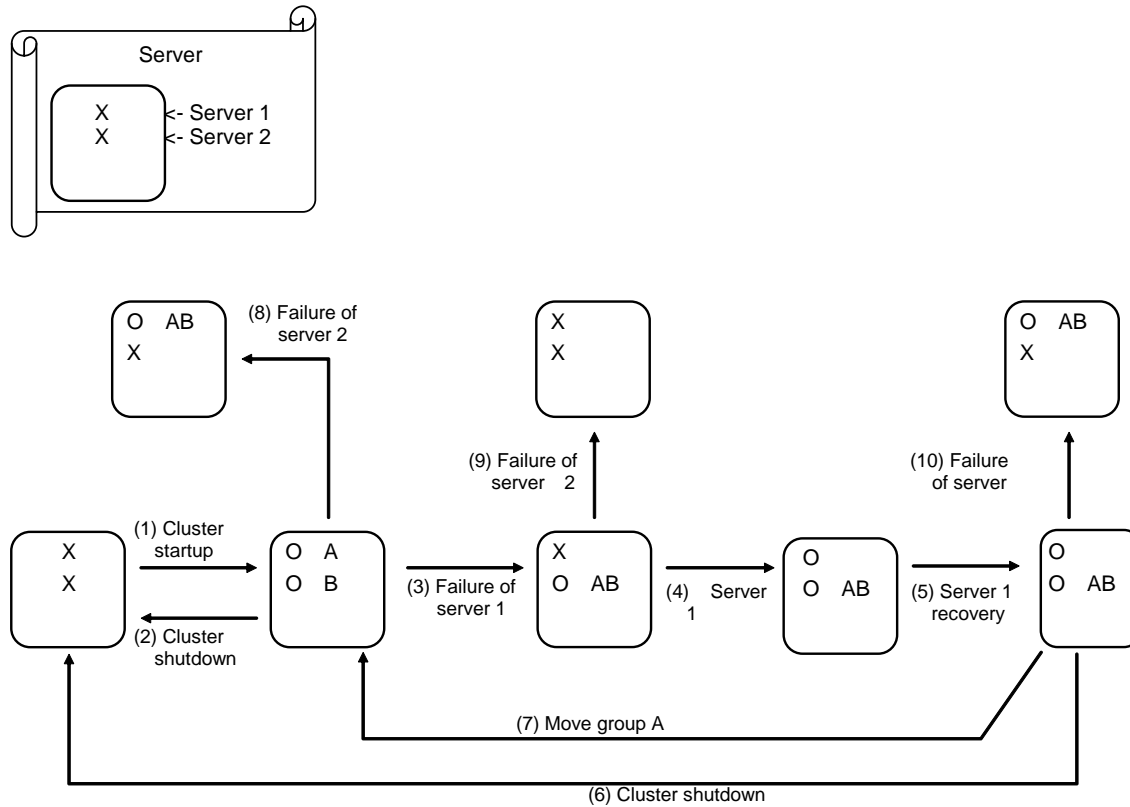

1. Cluster startup
2. Cluster shutdown
3. Failure of server1: Fails over to the standby server of Group A.
4. Server1 power on
5. Server1 cluster recovery
6. Cluster shutdown
7. Move group A
8. Failure of server2: Fails over to the standby server of Group B.
9. Failure of server2
10. Failure of server2: Fails over to the standby server.

Operations at detection of activation and inactivation errors

When an activation or deactivation error is detected, the following operations are performed:

- ◆ When an error in activation of group resources is detected:
 - When an error in activation of group resources is detected, activation is retried.
 - When activation retries fail as many times as the number set to **Retry Count at Activation Failure**, a failover to the server specified in **Failover destination** takes place.
 - If the failover fails as many times as the number set to **Failover Threshold**, the action configured in **Final Action** is performed.

- ◆ When an error in deactivation of group resources is detected:
 - When an error in deactivation of group resources is detected, deactivation is retried.
 - When deactivation retries fail as many times as the number set to **Retry Count at Deactivation Failure**, the action configured in **Final Action** is performed.

Note:

Failovers are counted on a server basis. **Failover Threshold** is the maximum failover count on a server.

The failover count is reset after the group has activated and the normal status continues for 10 minutes.

The following describes how an error in activation of group resources is detected:

When the following settings are made:

- Retry Count at Activation Failure 3 times
- Failover Threshold The same number as the number of servers
(In the following case, 2 times)
- Final Action Stop Group

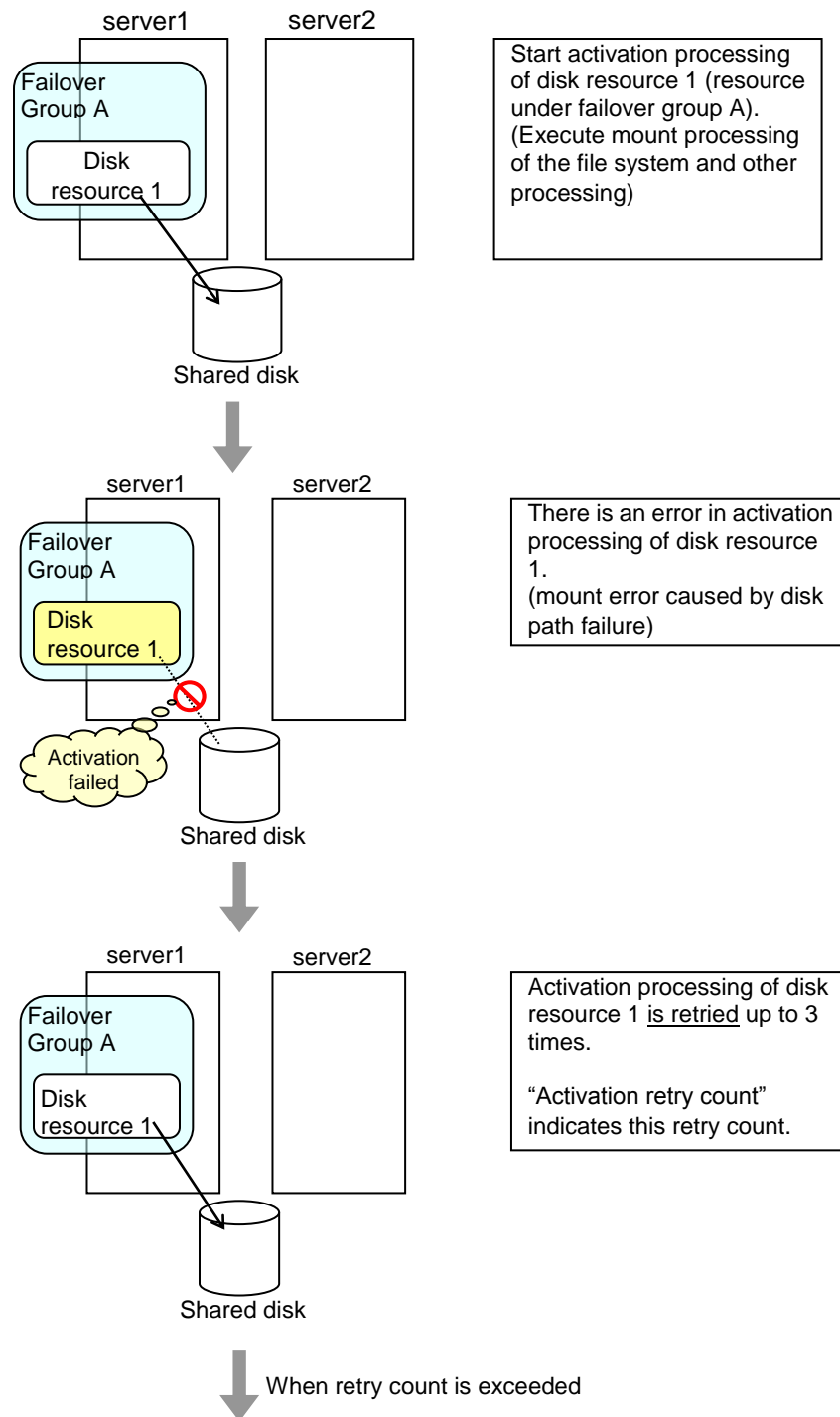

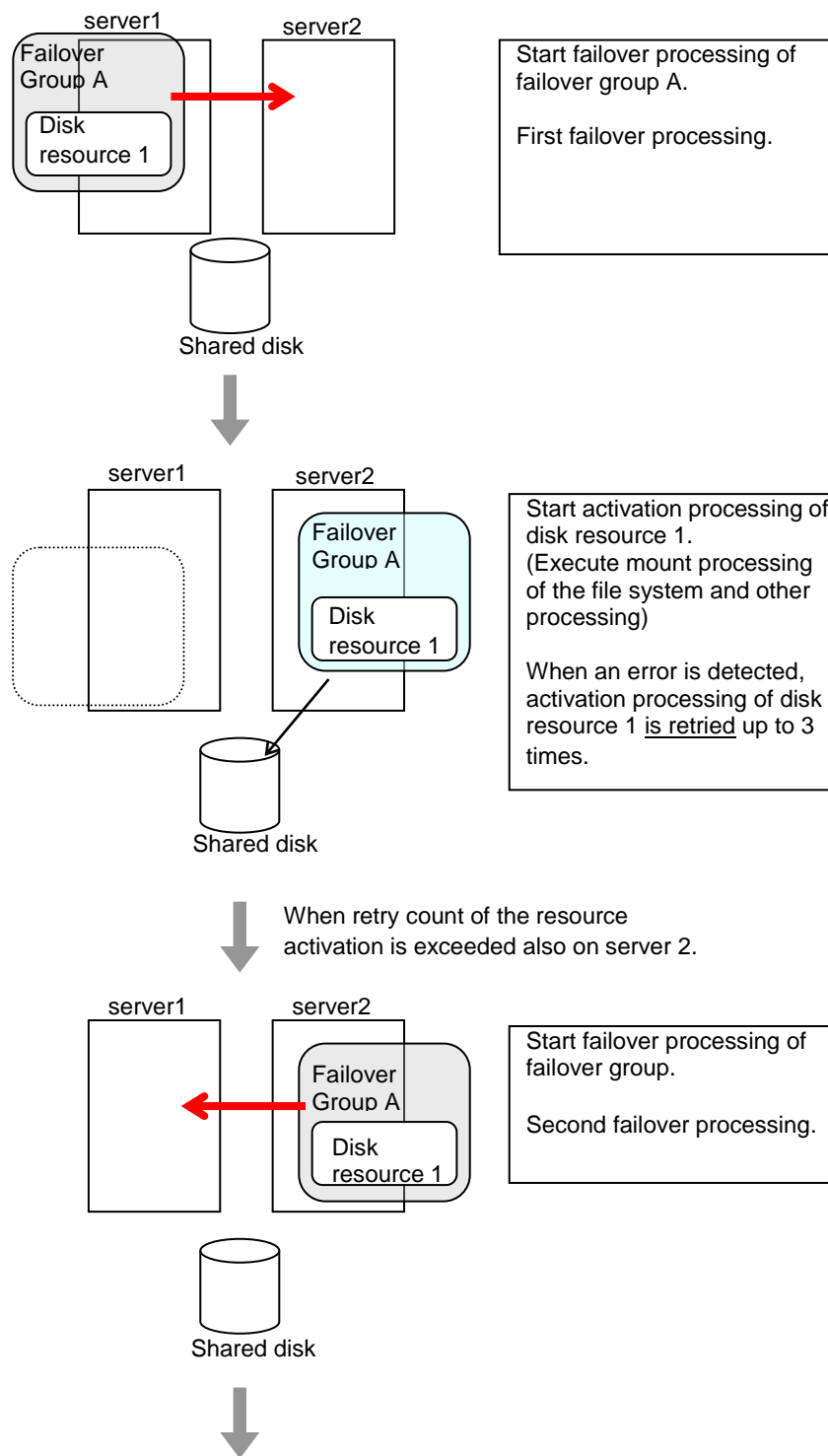

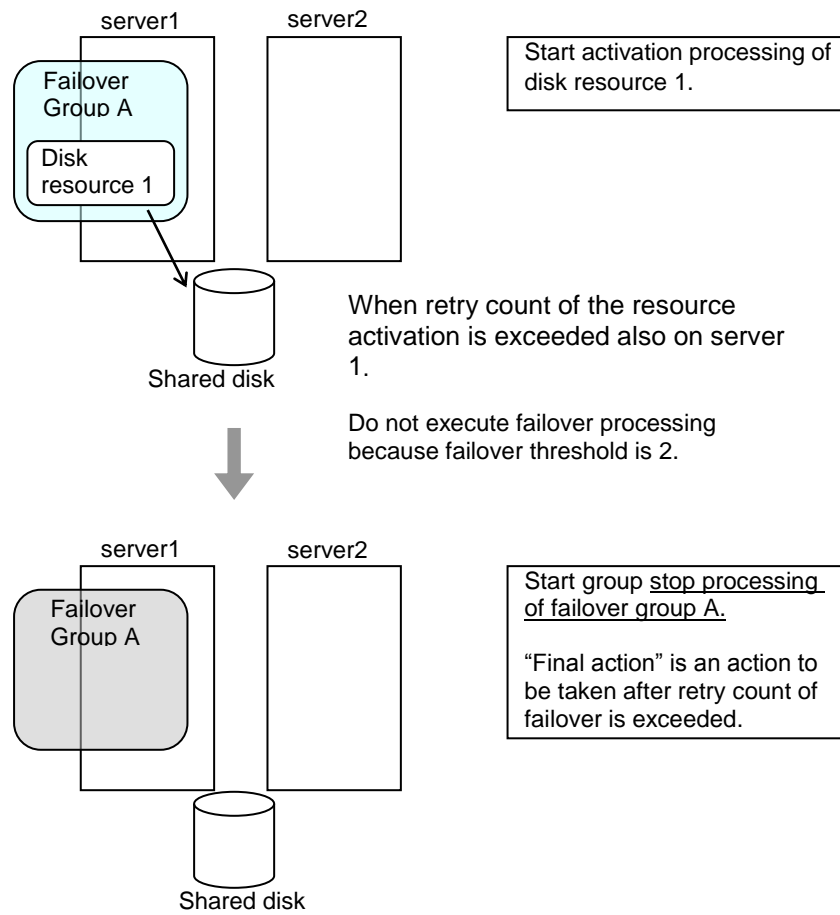

Final action

When activation fails even though the failover performed as many times as the number set to **Failover Threshold**, the action configured in **Final Action** is performed. The final action can be selected from the following operations.

- **No Operation (Activate next resource)**

Continues the group start process.

- **No Operation (Not activate next resource)**

Cancels the group start process.

- **Stop Group**

Deactivates all resources in the group which the group resource that an activation error is detected belongs.

- **Stop cluster service**

Stops the EXPRESSCLUSTER Server service of the server that an activation error is detected.

- **Stop the cluster service and shutdown OS**

Stops the EXPRESSCLUSTER Server service of the server that an activation error is detected, and shuts down the OS.

- **Stop cluster service and reboot OS**

Stops the EXPRESSCLUSTER Server service of the server that an activation error is detected, and reboots the OS.

- **Generating of intentional Stop Error**

Generate a stop error intentionally on the server that an activation error is detected.

Script before final action

When a group resource activation error is detected, a script before final action can be executed before the last action during detection of a deactivation error.

Environment variables used with a script before final action

When executing a script, EXPRESSCLUSTER sets information such as the state in which it is executed (when an activation error occurs, when a deactivation error occurs) in the environment variables.

Environment variable	Value	Description
CLP_TIMING ...Execution timing	START	Executes a script before final action in the event of a group resource activation error.
	STOP	Executes a script before final action in the event of a group resource deactivation error.
CLP_GROUPNAME ...Group name	Group name	Indicates the name of the group containing the group resource in which an error that causes the script before final action to be executed is detected.
CLP_RESOURCENAME ...Group resource name	Group resource name	Indicates the name of the group resource in which an error that causes the script before final action to be executed is detected.

Flow used to describe a script before final action

The following explains the environment variables in the previous topic and an actual script, associating them with each other.

Example of a script before final action in the event of an activation error

```

rem *****
rem *      predeactaction.bat      *
rem *****

echo START

IF "%CLP_TIMING%" == "STOP" GOTO NORMAL

rem *****
rem CLP_TIMING is not STOP (Error)
rem *****
echo NO_CLP
GOTO EXIT

rem *****
rem CLP_TIMING is STOP
rem *****
:NORMAL
echo %CLP_GROUPNAME%
echo %CLP_RESOURCE_NAME%

echo EXIT
:EXIT

```

Referring to the environment variable for the script execution cause, sort the processing.

Processing overview:
Recovery
Execution timing for performing this processing:
Before final action in the event of an activation error

Tips for creating a script before final action

Using `clplogcmd`, you can output messages to the alert view of WebManager.

Notes on script before final action

- ◆ Condition that a script before final action is executed
A script before final action is executed before the final action upon detection of a group resource activation or deactivation failure. Even if **No operation (Next Resources Are Activated/Deactivated)** or **No operation (Next Resources Are Not Activated/Deactivated)** is set as the final action, a script before final action is executed.
If the final action is not executed because the maximum restart count has reached the upper limit or by the function to suppress the final action when all other servers are being stopped, a script before final action is not executed.

Reboot count limit

If **Stop cluster service and shutdown OS** or **Stop cluster service and reboot OS** is selected as the final action to be taken when any error in activation or deactivation is detected, you can limit the number of shutdowns or reboots caused by detection of activation or deactivation errors.

This maximum reboot count is the upper limit of reboot count of each server.

Note:

The maximum reboot count is the upper limit of reboot count of a server because the number of reboots is recorded per server.

The number of reboots that are taken as a final action in detection of an error in group activation or deactivation and those by monitor resources are recorded separately.

If the time to reset the maximum reboot count is set to zero (0), the reboot count is not reset. To reset the reboot count, use the `clpregctrl` command.

The following describes the flow of operations when the limitation of reboot count is set as shown below:

As a final action, **Stop cluster service and reboot OS** is executed once because the maximum reboot count is set to one (1).

If the EXPRESSCLUSTER Server service is started successfully after rebooting OS, the reboot count is reset after 10 minutes because the time to reset maximum reboot count is set to 10 minutes.

Setting example

Retry Count at Activation Failure	0
Failover Threshold	0
Final Action	Stop cluster service and reboot OS
Max Reboot Count	1
Max Reboot Count Reset Time	10 minutes

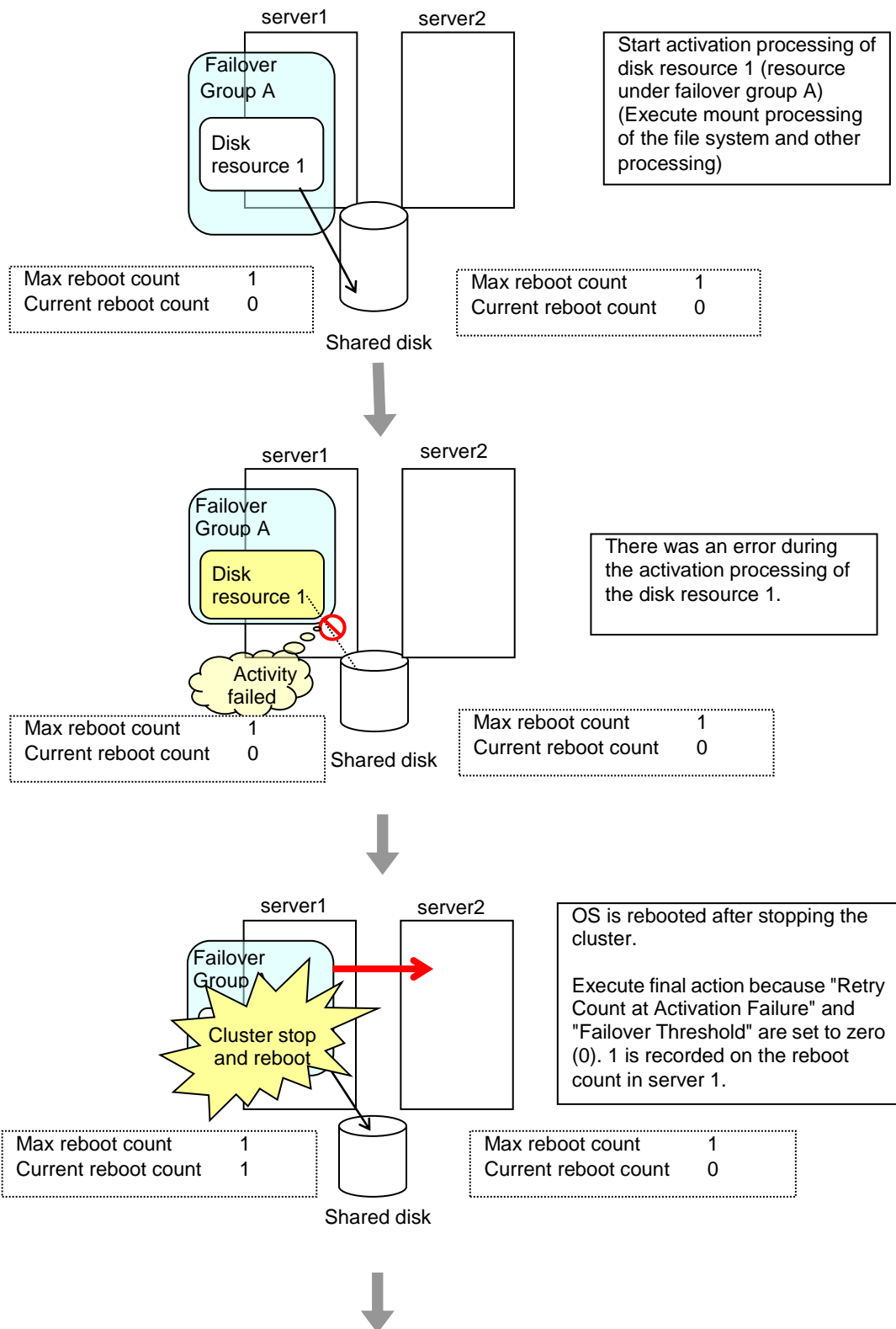

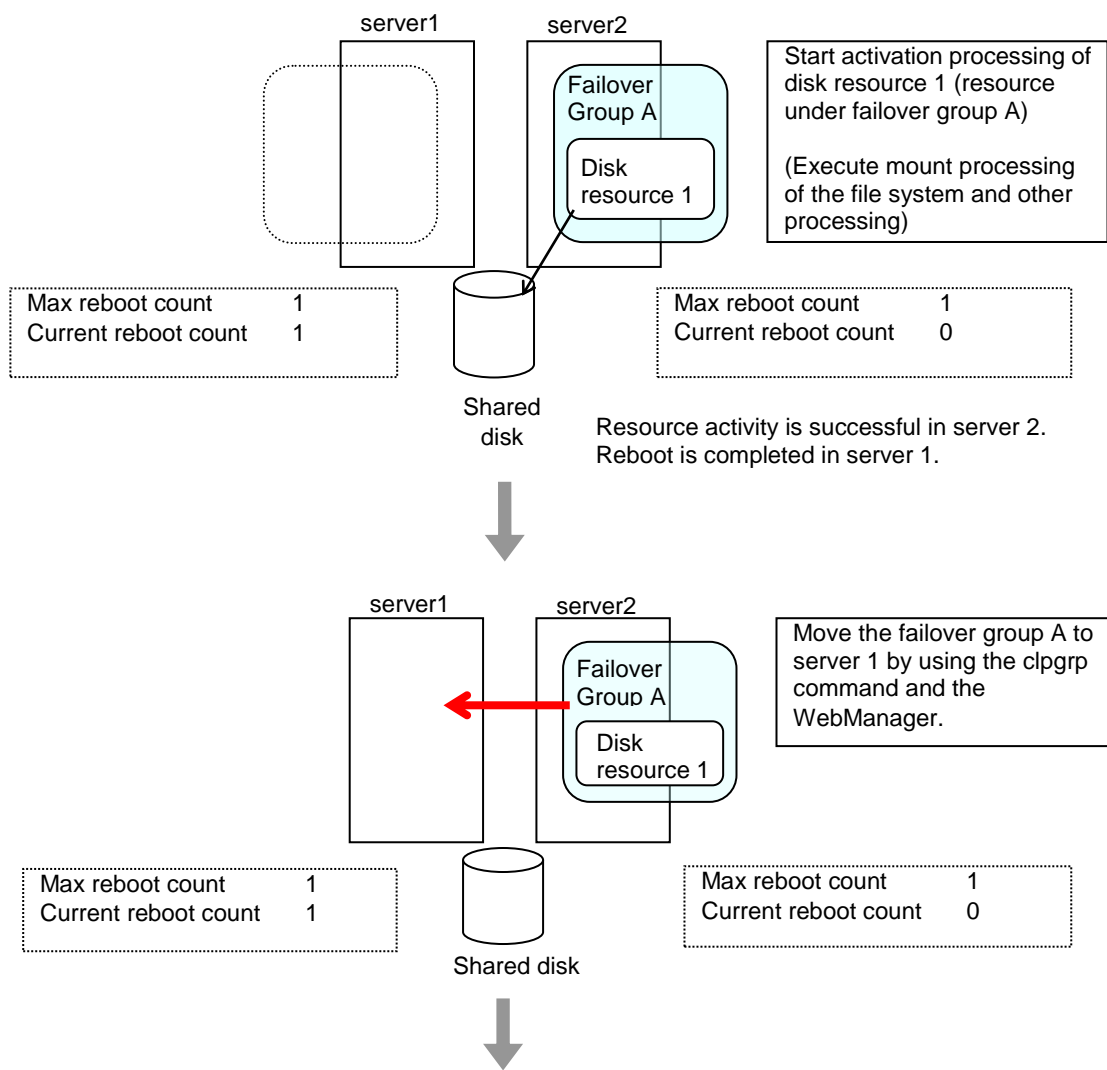

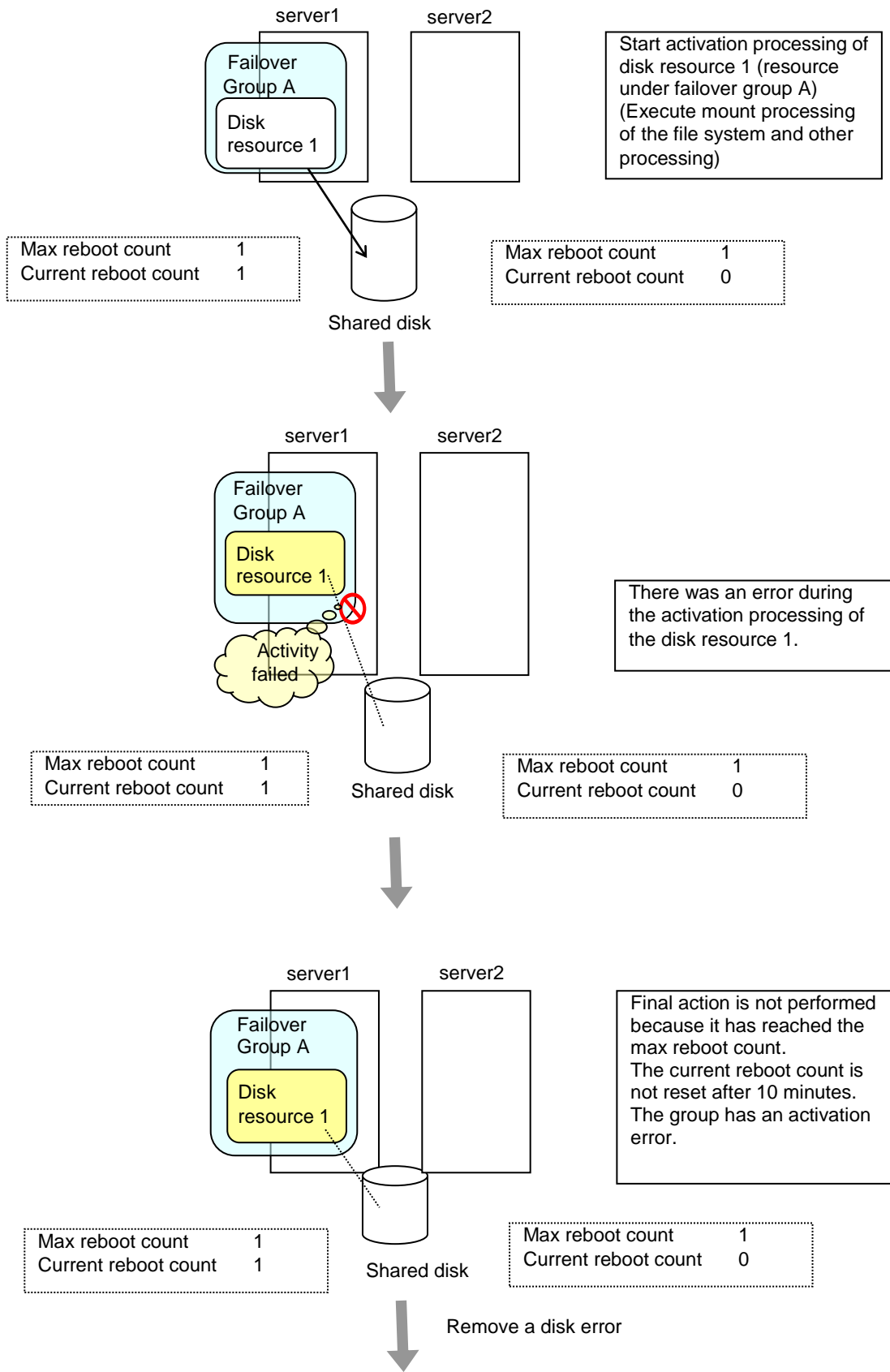

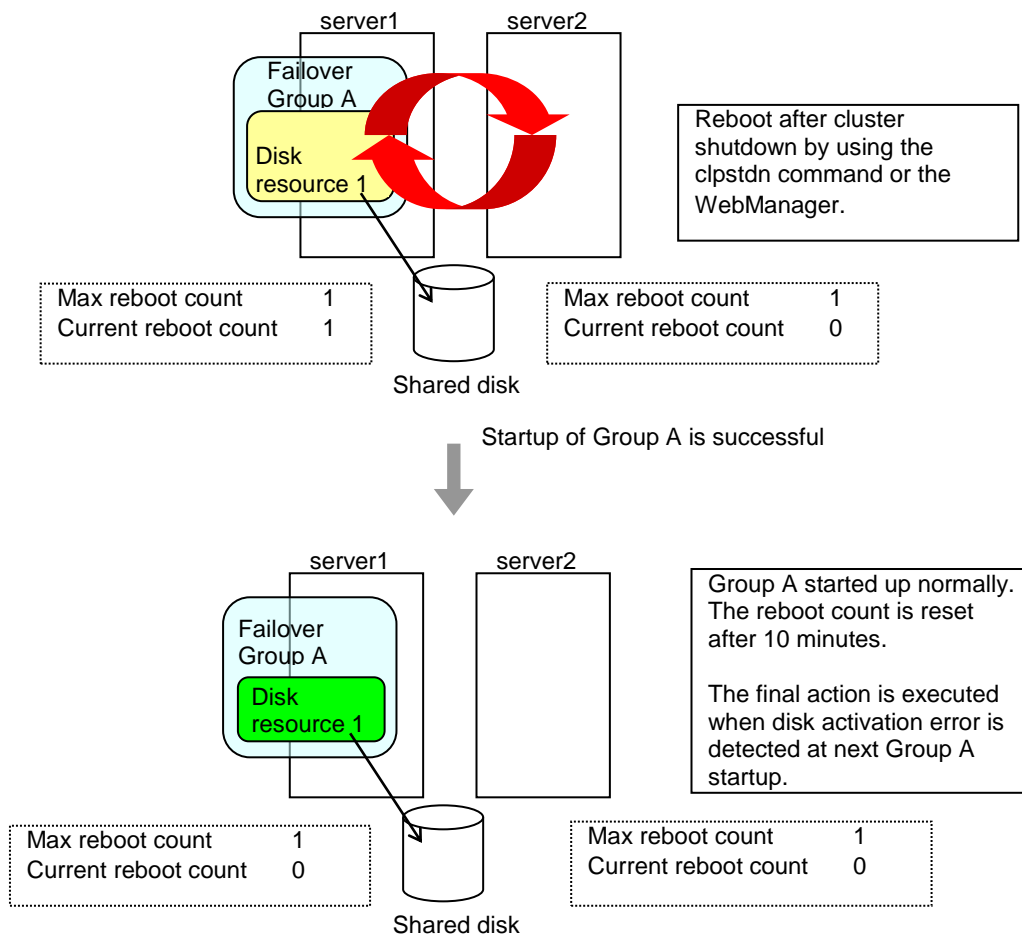

Resetting the reboot count

Run the `clpregctl` command to reset the reboot count. For details on the `clpregctl` command, see “Controlling reboot count (`clpregctl` command)” in Chapter 3, “EXPRESSCLUSTER command reference” in this guide.

Group start dependence and group stop dependence

You can control the group start order by setting the group to which you want to apply start dependence and that to which you want to apply stop dependence.

Note that, regarding group stop dependence, a group stop operation of the WebManager or `clpgrp` command does not apply stop dependence. Group stop dependence is applied according to the setting (when the cluster or a server stops) made with the Builder.

The following explains group start execution using examples of simple status transition.

When two servers have three groups

Group failover policy

```
groupA server1
groupB server2
groupC server1 → server2
```

Group start dependence setting

```
groupA Start dependence is not set.
groupB Start dependence is not set.
groupC groupA start dependence is set.
```

Start dependence is set when groupC is started by the server of groupB.

1. When server1 starts groupA and groupC

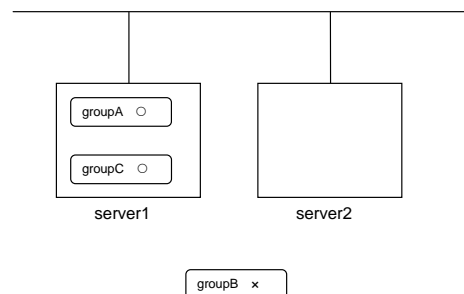

2. When server1 starts groupA and server2 starts groupC

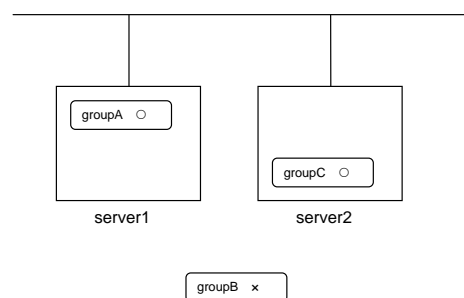

Wait Only when on the Same Server is not set, so groupA start dependence by another server is applied.

- When server1 starts groupC and server2 starts groupB

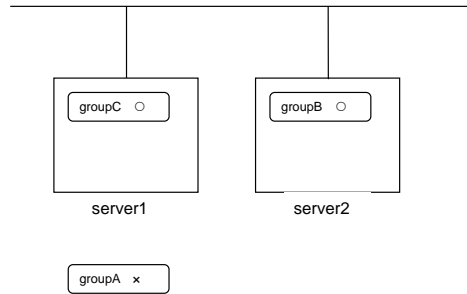

server1 starts groupC without waiting for the normal start of groupB. groupC is set to wait for groupB start only when it is started by the same server. However, start dependence is not applied to groupC because groupB is set such that it is not started by server1.

- When server1 starts groupA and groupC

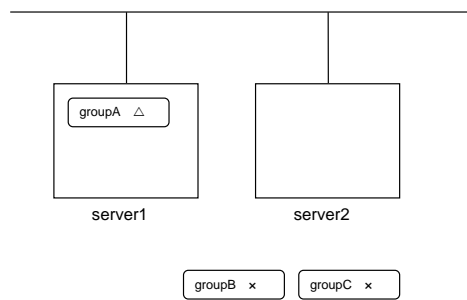

If server1 fails in groupA start, groupC is not started.

- When server1 starts groupA and groupC

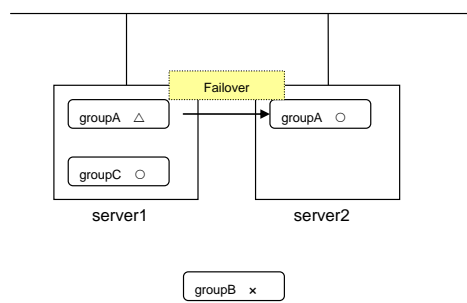

If server1 fails in groupA start and a failover occurs in server2 due to groupA resource recovery, server2 starts groupA and then server1 starts groupC.

6. When server1 starts groupA and groupC

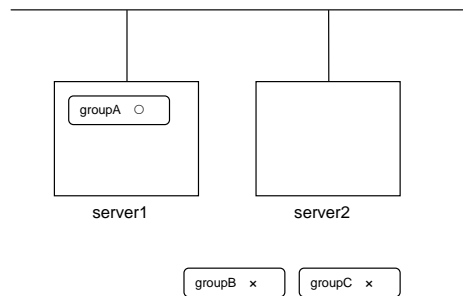

If a groupA start dependence timeout occurs on server1, groupC is not started.

7. When server1 starts only groupC

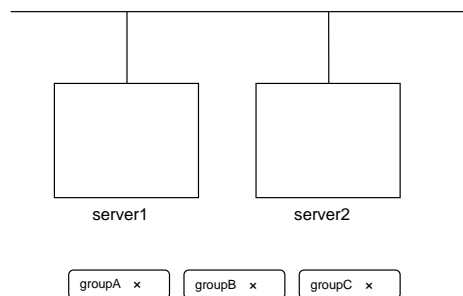

server1 has not started groupA, so a start dependence timeout occurs. If this timeout occurs, groupC is not started.

Notes:

- ◆ When a group is started, there is no function to automatically start the group for which start dependence is set.
- ◆ The group is not started if a timeout occurs in the group for which start dependence is set.
- ◆ The group is not started if the group for which start dependence is set fails to start.
- ◆ If the group for which start dependence is set has both a normally started resource and a stopped resource, the group is judged to have already been normally started.
- ◆ When a group is stopped, there is no function to automatically stop the group for which stop dependence is set.
- ◆ Group stop processing continues if a timeout occurs in a group for which stop dependence is set.
- ◆ Group stop processing continues if a group for which stop dependence is set fails to stop.
- ◆ The group stop processing or resource stop processing by the WebManager or clpgrp command does not apply stop dependence. Stop dependence is applied according to the setting (when the cluster or a server stops) made with the Builder.
- ◆ At the timing of a failover, if a start waiting timeout occurs, the failover fails

Displaying and changing the settings of group properties

You can display and change the settings of the group properties by using **Resources** tab of the Builder.

Renaming a group

SuspendResume GroupStopRestart

1. In the tree view in the left pane of the Builder, right-click the icon of the group that you want to rename, and then click **Rename Group**.
2. The **Change Group Name** dialog box is displayed. Enter a new name.

Displaying and changing the comment of a group

1. In the tree view in the left pane of the Builder, right-click the icon of the group that you want to change its comment, and then click **Properties**. The **Group Properties** dialog box is shown.
2. On the **Info** tab, the group name and comment are displayed. Enter a new comment.

Note:

You cannot change the group name on the **Info** tab. To change the group name, right-click the icon of the group as described in the step 1 above. Click **Rename Group** and enter a new name.

Displaying and changing the settings of servers that starts up the group

There are two types of settings for the server that starts up the group: starting up the group on all servers or on only the specified servers and server groups that can run the group.

If the setting on which the group is started up by all the servers is configured, all the servers in a cluster can start a group. The group startup priority of servers is same as the one of servers. For details on the server priority, see “Server properties Master Server tab” in Chapter 2 “Functions of the Builder” in this guide.

When selecting servers and server groups that can run the group, you can select any server or server group from those registered to the cluster. You can also change the startup priority of servers and server groups that can run the group.

Run the following steps when setting the server group which start up the failover group.

1. In the tree view in the left pane of the Builder, right-click the icon of the group with servers whose settings you want to display and change, and then click **Properties**.
2. In the **Group Properties** dialog box, click **Startup Server** tab. In **Servers that can run the Group**, servers that can start the group and their priority are shown. In **Available Servers**, the servers that can be registered with **Servers that can run the Group** are shown.

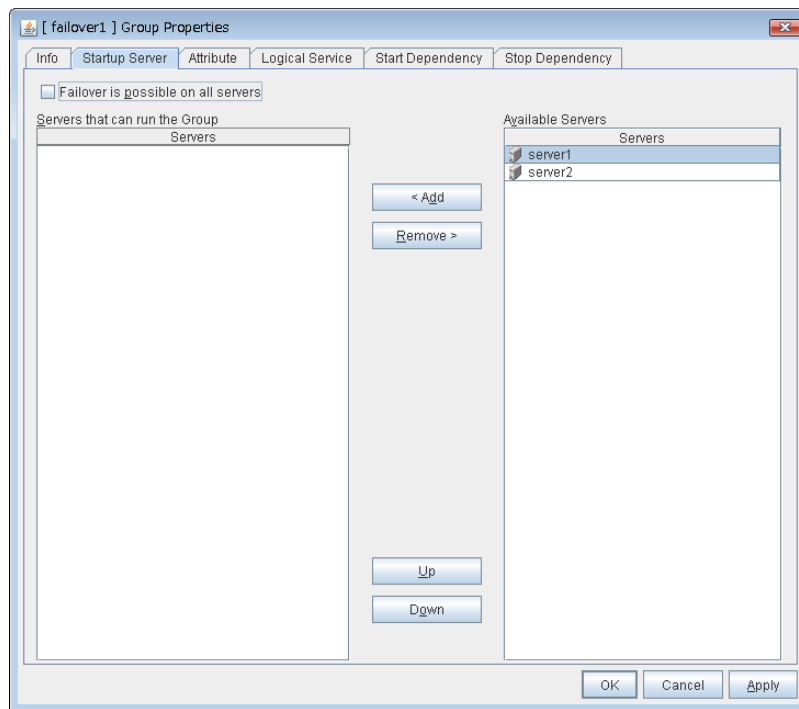

3. Set the startup servers by following the procedures below:

Failover is possible on all servers **SuspendResume**

Specify the server that starts a group.

- When the checkbox is selected:
All servers registered to a cluster can start a group. The priority of starting up a group is the same as the one of the servers.
- When not selected
You can select the servers that can start a group, and change the startup priority.

Add **SuspendResume**

Use this button to add a server. Select a server that you want to add from **Available Servers**, and then click **Add**. The server is added to **Servers that can run the Group**.

Remove **SuspendResume**

Use this button to remove a server. Select a server that you want to remove from **Servers that can run the Group**, and then click **Remove**. The server is added to **Available Servers**.

Up, Down **SuspendResume**

Use these buttons to change the priority of the servers that can be started. Select a server whose priority you want to change from **Servers that can run the Group**. Click **Up** or **Down** to move the selected row upward or downward.

When using the server group settings, execute the following steps. In case of the group including the hybrid disk resource, it is necessary to configure the server that can run a group using the server group settings. For server group settings, see “Server properties” in Chapter 2, “Functions of the Builder” in this guide.

1. In the tree view in the left pane of the Builder, right-click the icon of the group with servers whose settings you want to display and change, and then click **Properties**. The **Group Properties** dialog box is displayed.
2. Check **Use Server Group Settings** in **Info** tab on.
3. Click **Server Groups** tab. In **Servers Groups that can run the Group**, servers groups that can start the group and their order are shown. The smaller number a server has, the higher its priority is. In **Available Server Groups**, the servers that can be registered with **Servers Group that can run the Group** are shown.

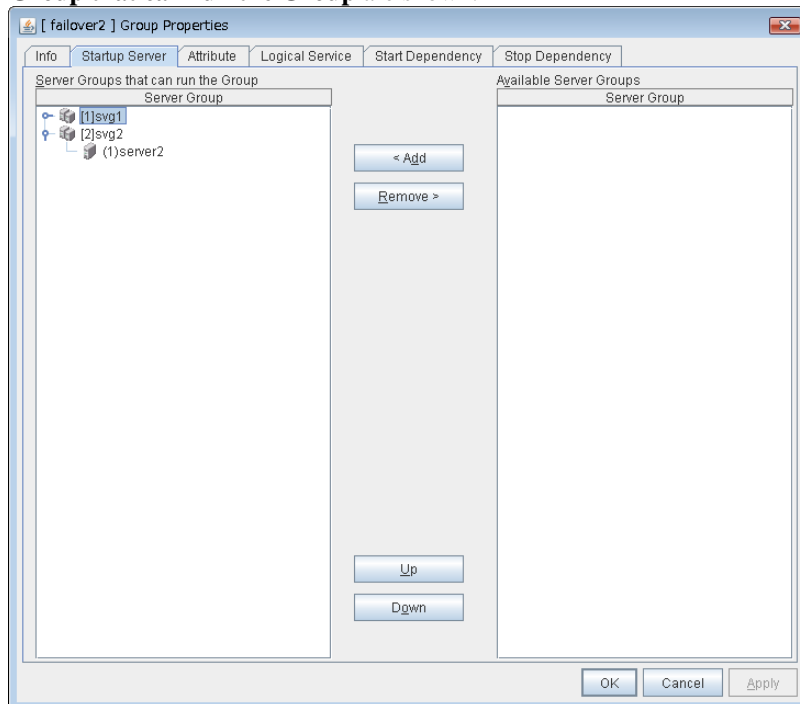

4. Configure the settings for the server that can run the group according to the following instruction.

Add **SuspendResume**

Use this button to add a server group to server groups you use. Select a server group that you want to add from **Available Server Groups**, and then click **Add**. The server group is added to **Server Groups that can run the Group**.

Remove **SuspendResume**

Use this button to remove a server group from server groups you use. Select a server group that you want to remove from **Available Server Groups**, and then click **Remove**. The server is added to **Server Groups that can run the Group**.

Up, Down **SuspendResume**

Use these buttons to change the priority of the server groups that can run a group. Select a server groups whose priority you want to change from **Server Groups that can run the Group**. Click **Up** or **Down** to move the selected row upward or downward.

Displaying and changing the group attribute

1. In the tree view in the left pane of the Builder, right-click the icon of the group that you want to show/change its settings of the attribute, and then click **Properties**.
2. In the **Group Properties** dialog box, click the **Attribute** tab. Specify **Startup Attribute**, **Failover Attribute**, and **Failback Attribute**, **Failover Exclusive Attribute** of this group by following the procedures on the next page:

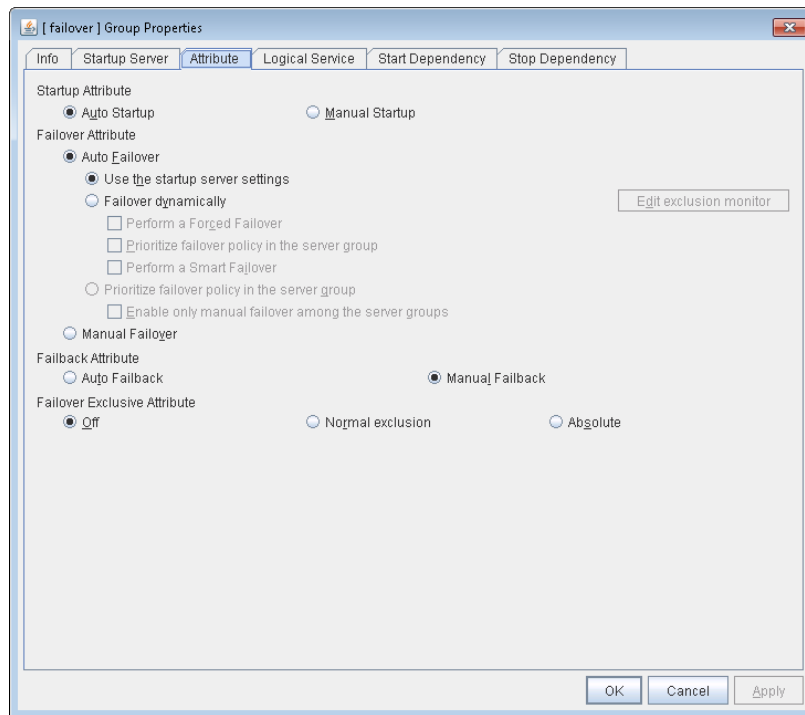

Startup Attribute **SuspendResume**

Select whether to automatically start the group from EXPRESSCLUSTER (auto startup), or to manually start from the WebManager or by using the clpgrp command (manual startup) at the cluster startup.

Failover Attribute **SuspendResume**

Select if the failover is performed automatically when server fails.

Failback Attribute **SuspendResume**

Select if the failback is performed automatically to the group when a server that has a higher priority than other server where the group is active is started. For groups that have mirror disk resources or hybrid disk resources, select manual failback.

Failover Exclusive Attribute **SuspendResume**

This attribute determines the server to which EXPRESSCLUSTER automatically fails over. You can select from Off, Normal, and Absolute.

Note:

When failover attribute is **Fail over dynamically**, the failover exclusive attributes cannot be set.

For details on the group attribute, see “What is a group?” on page 521.

Edit Exclusion Monitor **SuspendResume**

Dynamic failover excludes the server for which the monitor resource has detected an error, from the failover destinations. If **Failover dynamically** is selected as the failover attribute, you can set the monitor resource to be excluded.

The exclusive monitor can be set with the monitor resource type and monitor resource name.

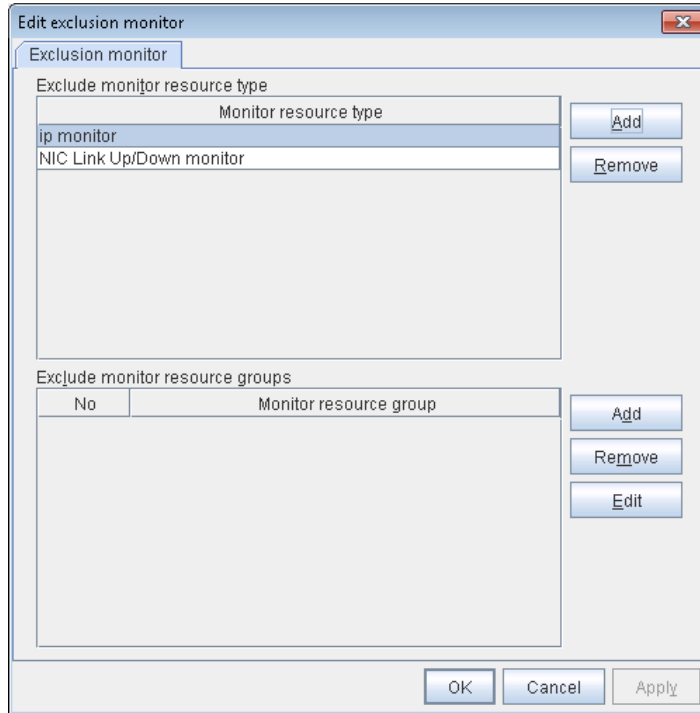

- Add exclusive monitor resource type

Adds the exclusive monitor resource type.

Any server, in which even one monitor resource of the added monitor resource type is abnormal, is excluded from the failover destinations.

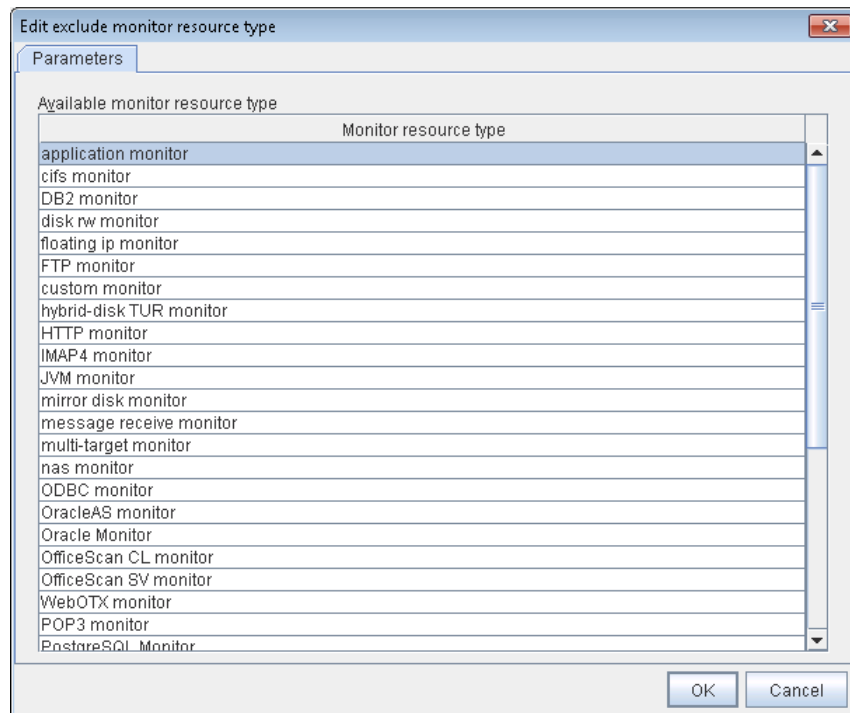

Adds the selected monitor resource type.

- Remove exclusive monitor resource type

Removes the selected exclusive monitor resource type.

- Add exclusive monitor resource group

Adds the exclusive monitor resource group.

The maximum number of exclusive monitor resource groups to be registered is 32.

If multiple monitor resources are registered in a single exclusive monitor resource group, the server in which all the registered monitor resources are abnormal is excluded from the failover destinations.

Moreover, if multiple exclusive monitor resource groups are registered, a server that satisfies at least one of the conditions is excluded from the failover destinations.

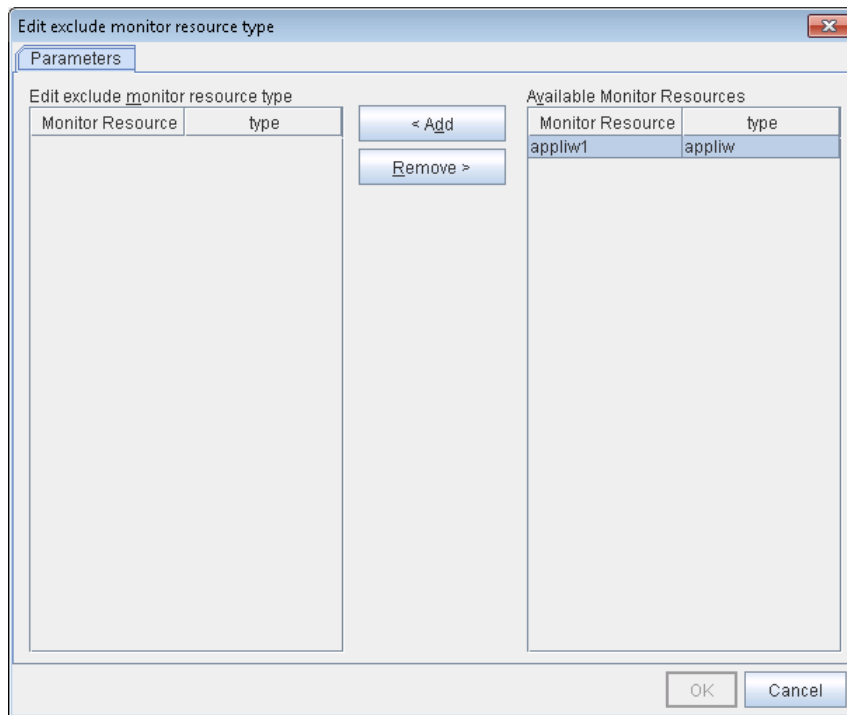

Add

Adds the monitor resource selected from **Available monitor resource list** to **Monitor resource list**.

Remove

Removes the monitor resource selected with **Monitor resource list**, from the list.

- Delete exclusive monitor resource group
Removes the selected exclusive monitor resource group.
- Edit exclusive monitor resource group
Edits the selected exclusive monitor resource group.

Note:

The following monitor resource types cannot be registered for the exclusive monitor resource type. Moreover, a resource name cannot be registered for the exclusive monitor resource group.

- Hybrid disk monitor
 - Mirror disk connect monitor
-

Note:

The monitor resource in the warning status is not handled as being abnormal. However, the mirror disk monitor resource is excluded.

The monitor resource set for monitoring at activation does not enter the abnormal status because it does not perform monitoring for a server other than the group start server.

The monitor resource stopped with the WebManager or clpmonctrl command enters the normal status.

A server that has not been set to monitor a monitor resource does not enter the abnormal status because it does not perform monitoring.

Note:

For the mirror disk monitor resource, any abnormality is determined from whether the mirror disk resource can be activated. This determination does not depend on the status of the mirror disk monitor resource.

Even if the mirror disk monitor resource is in the abnormal status, the server on which the mirror disk resource can be activated normally is not excluded from the failover destinations.

Even if the mirror disk monitor resource is in the normal or warning status, any server on which the mirror disk resource cannot be activated normally is excluded from the failover destinations.

Before the initial mirror configuration, the failover group may fail to start. It is recommended that the mirror disk monitor resource be registered in the exclusive monitor after the initial mirror configuration.

Note:

If the internal version is 11.14 or earlier, group reactivation or group resource reactivation by the recovery action can not work while the exclusive monitor resource detects an error.

If the internal version is 11.15 or later, group reactivation or group resource reactivation can work. If you update it to 11.15 or later, please be careful about what the behavior of the recovery action may change.

Displaying and changing Logical Service

1. In the tree view in the left pane of the Builder, right-click the icon of the group of which you want to change the attribute, and click **Properties**. The **Group Properties** dialog box is displayed.
2. Click the **Logical Service** tab. Add a logical service to the **Logical Service**.

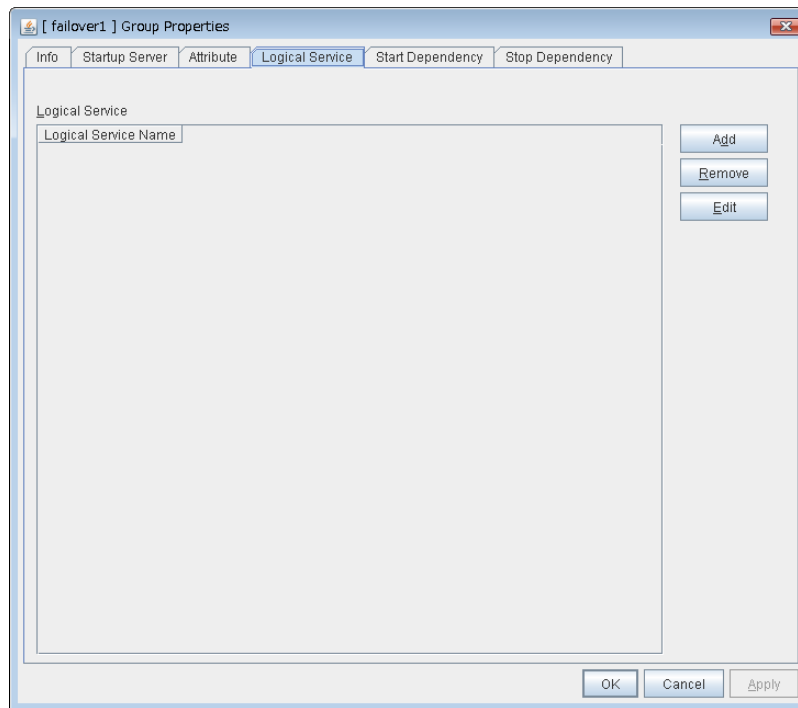

Add

Use this button to add a logical service to the **Logical Service**.

Up to 48 logical service names can be registered within the failover group. The same logical service name can be registered multiple times as long as it is registered with different failover groups.

Remove

Use this button to delete the selected logical service name from the **Logical Service**.

Edit

Use this button to display the **Enter the logical service name** dialog box.

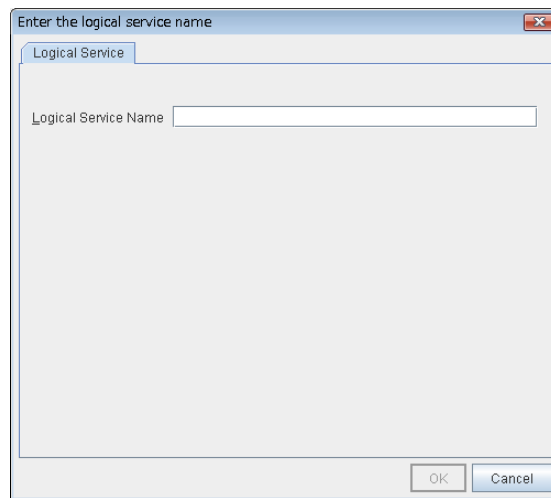

Logical Service Name Within 31 bytes

Enter the Logical Service Name that you want to add within 31 bytes.

For details on the logical service, see “What is a group?” on page 521.

Understanding setting of group start dependence and group stop dependence

You can set the group start and stop order by setting group start dependence and group stop dependence.

- ◆ When group start dependence is set:
 - For group start, start processing of this group is performed after start processing of the group subject to start dependence completes normally.
 - For group start, if a timeout occurs in the group for which start dependence is set, the group does not start.
- ◆ When group stop dependence is set:
 - For group stop, stop processing of this group is performed after stop processing of the group subject to stop dependence completes normally.
 - If a timeout occurs in the group for which stop dependence is set, the group stop processing continues.
 - Stop waiting isn't performed by group stop processing of WebManager or the clgrp command. Stop waiting is performed only according to the condition specified by Builder (a cluster stop or a cluster shutdown).

To display the settings made for group start dependence and group stop dependence, click the **groups** icon in the tree view displayed in the left part of Builder and then click the **Start Dependency** tab and the **Stop Dependency** tab in the table view displayed in the right part.

Depths for group start dependence are listed below as an example.

Group	Start Dependency	Stop Dependency
Depth	Name	Dependent Group Name
0	failover1	none
1	failover2	failover1
2	failover3	failover2

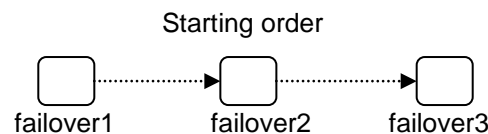

Displaying and setting group start dependence and group stop dependence

Set the start dependence and stop dependence for each group.

1. In the tree view displayed in the left part of Builder, click the **Groups** icon.
2. Groups are listed in the table view in the right part. Right-click the group for which you want to display and set dependence and then click the **Start Dependency** tab and the **Stop Dependency** tab of **Properties**.
3. Set the start dependence according to the following description:
 - From **Available Group**, select a start dependence target group.
 - Click **Add**.
 - The added group is added to **Dependent Group**.
 - To change the properties, select a group from **Dependent Group**.
 - Click **Property**.
 - Select the **Wait Only when on the Same Server** check box.
4. Set the stop dependence according to the following description:
 - From **Available Group**, select a stop dependence target group.
 - Click **Add**.
 - The selected group is added to **Dependent Group**.
 - If you want to apply group stop dependence when the cluster stops, select **Wait the Dependent Groups when a Cluster Stops**.
 - If you want to apply group stop dependence when a server stops, select **Wait the Dependent Groups when a Server Stops**.

Group Properties – Start Dependency tab

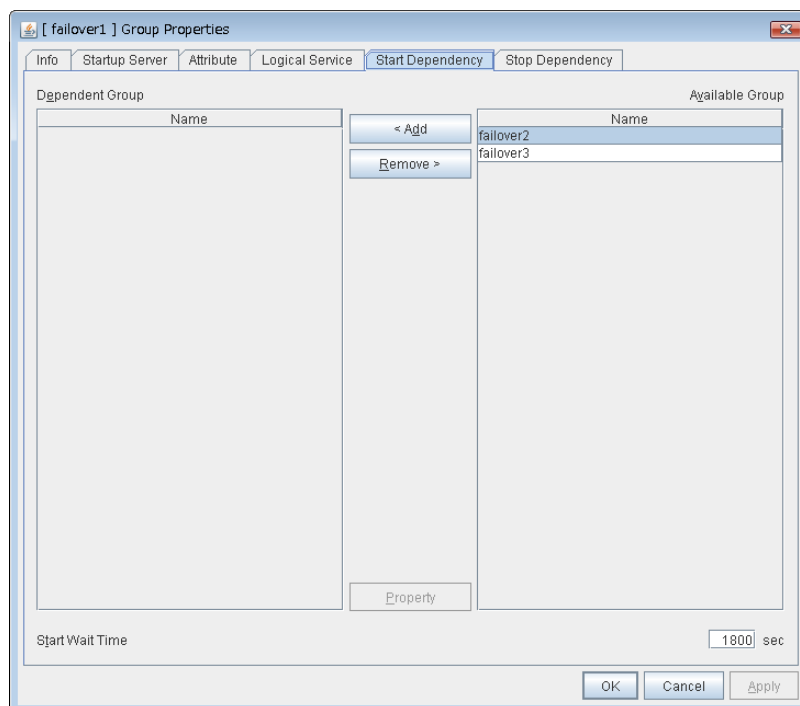

Add

Clicking **Add** adds the group selected from **Available Group** to **Dependent Group**.

Remove

Clicking **Remove** removes the group selected from **Dependent Group** from **Dependent Group**.

Start Wait Time 0 to 9999

Specify how many seconds to wait before a timeout occurs in the target group start processing. The default value is 1800 seconds.

Property

Clicking **Property** changes the properties of the group selected from **Dependent Group**.

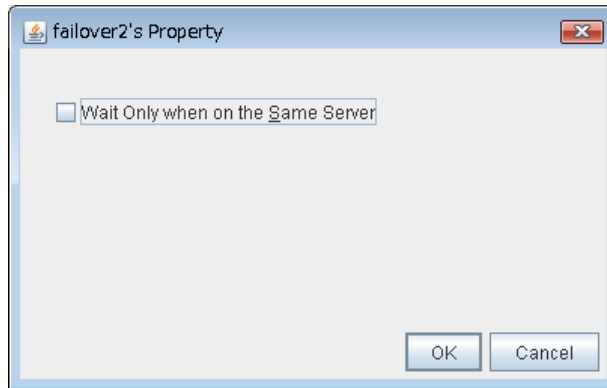

Wait Only when on the Same Server

Specify whether to wait for starting only if the group for which start waiting is specified and the target group are starting on the same server.

If the server on which the group with start waiting specified starts is not included as the Startup Server of the target group, waiting is not required.

If a target group fails to start on a server other than the server on which the group with start waiting specified is starting, waiting is not required.

Group Properties – Stop Dependency tab

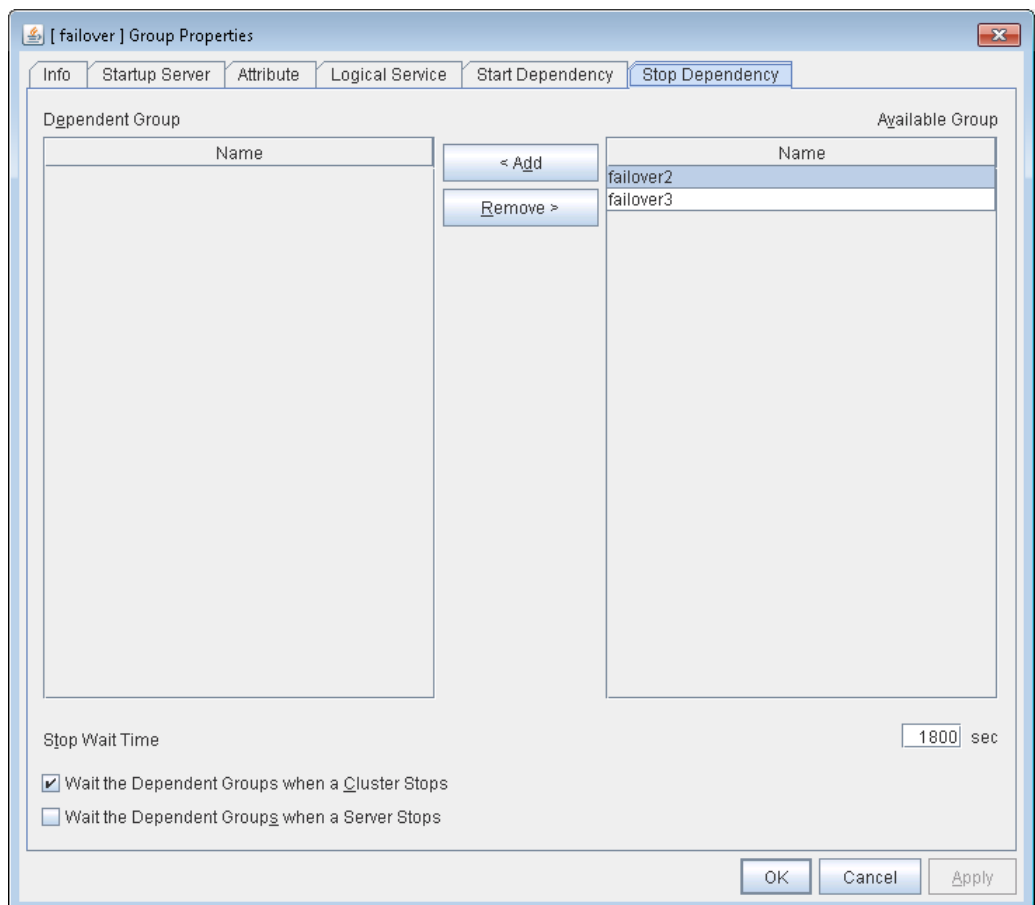

Add

Clicking **Add** adds the group selected from **Available Group** to **Dependent Group**.

Remove

Clicking **Remove** removes the group selected from **Dependent Group** from **Dependent Group**.

Stop Wait Time 0 to 9999

Specify how many seconds to wait before a timeout occurs in the target group stop processing. The default value is 1800 seconds.

Wait the Dependent Groups when a Cluster Stops

Specify whether to wait for the dependent groups to stop when the cluster stops.

Wait the Dependent Groups when a Server Stops

Specify whether to wait for the dependent groups to stop when a single server stops. This option waits for the stop of only those groups running on the same server, among all the dependent groups.

Displaying and changing the settings of group resources

You can display and change the settings of the group resources by using the **Resource Properties** in the Builder.

Renaming a group resource

Suspend/Resume **Group Stop/Restart**

1. In the tree view in the left pane of the Builder, click the icon of the group to which the group resource that you want to rename belongs. The list of selected group resources is shown on the table view in the right pane of the screen.
2. Right-click the name of the group resource that you want to rename, and then click **Rename Resource**.
3. The **Change Resource Name** dialog box is displayed. Enter a new name.

Displaying and changing the comment of a group resource

1. In the tree view in the left pane of the Builder, click the icon of the group to which the group resource whose comment you want to change belongs. Group resources of the selected group will be listed on the table view in the right pane of the screen.
2. Right-click the name of the group resource whose comment you want to display or change, and click **Properties**.
3. On the **Info** tab, the group resource name and comment are shown. Enter new comment (within 127 bytes).

Note:

You cannot change the group resource name on the **Info** tab. To change the group name, right-click the icon of the group resource as described in the step 1 above. Click **Rename Group** and enter new name.

Understanding the settings of dependency among group resources

By specifying dependency among group resources, you can specify the order of activating them.

- ◆ When the dependency among group resources is set:
 - When activating a failover group that a group resource belongs to, its activation starts after the activation of the **Dependent Resources** is completed.
 - When deactivating a group resource, the deactivation of the “Dependent Resources” starts after the deactivation of the group resource is completed.

To display the settings of dependency among group resources, click the icon of the group whose group resources dependency you want to view on the tree view shown in the left pane of the Builder, and then click the **Dependency List** tab on the table view shown in the right pane of the Builder.

The following shows an example of the depth of dependency of resources that belong to a group.

Resources		Entire Dependency	
Depth	Name	Dependent Resource Name	Type
0	fip1	none	
1	sd1	fip1	floating ip resource
2	appli1	fip1	floating ip resource
		sd1	disk resource

Activation order

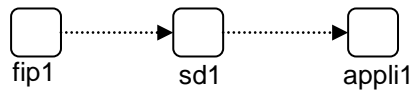

Deactivation order

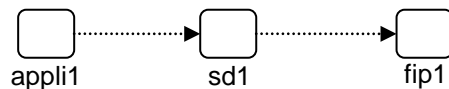

Displaying and configuring the settings of dependency among group resources

Set the dependent group resources on a group resource basis.

1. In the tree view shown in the left pane of the Builder, click the icon of the group to which the group resource whose settings of dependency you want to display or configure belongs.
2. In list of group resources shown in the table view in the right pane, right-click the group resource whose dependency settings you want to display and configure. Click **Properties**, and then click the **Dependency** tab.
3. Set the dependency as described below:

- ◆ When **Follow the default dependence** is selected:

Default dependency resource type is shown in **Dependent Resources**.

Nothing is shown in **Available Resources**.

- ◆ When **Follow the default dependence** is not selected:

Group resource names and types are shown in **Dependent Resources**.

Group resources that can be added to **Dependent Resources** are listed in **Available Resources**. Group resources whose dependency is looped (that depend on depended group resource) are not shown. Group resources in **Dependent Resources** are not shown either.

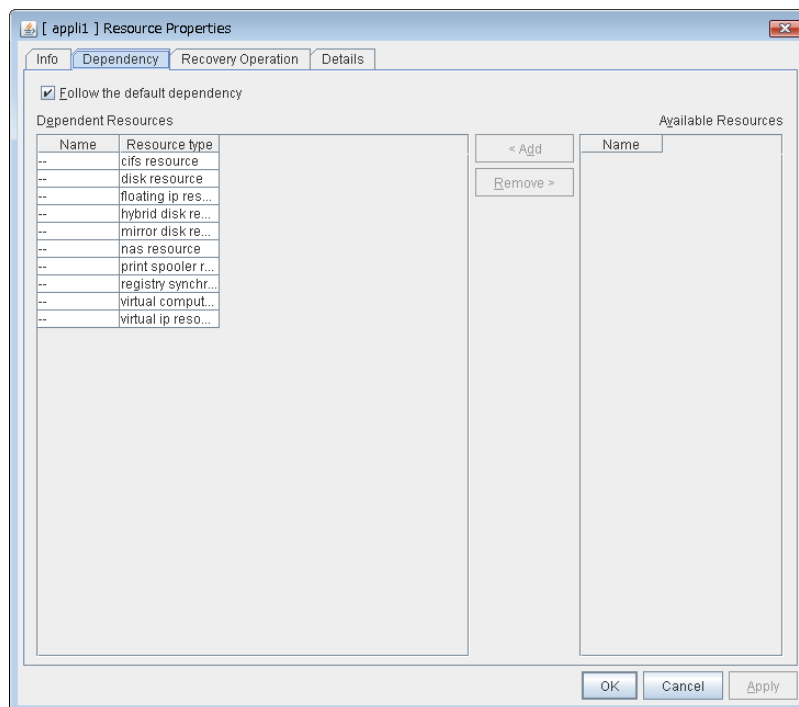

Follow the default dependence **SuspendResume** **GroupStopRestart**

Select if the selected group resource follows the default EXPRESSCLUSTER dependency.

- ◆ When Follow the default dependence is selected:
The selected group resource depends on the type(s) of resources. For the default dependency of each resource, see “Parameters list” in Chapter 2, “Functions of the Builder” in this guide. When there is more than one resource of the same type, the selected group resource depends on all resources of that type.
- ◆ When Follow the default dependence is not selected:
The selected group resource depends on the specified resource.

Add **SuspendResume** **GroupStopRestart**

It is used when adding the group resource selected in **Available Resources** to **Dependent Resources**.

Remove **SuspendResume** **GroupStopRestart**

It is used when removing the group resource selected in **Dependent Resources** from **Dependent Resources**.

Displaying and changing the operation settings when a group resource error is detected

You can display and change the operation settings of actions when a group resource error is detected (when group resources are active/inactive) by using the **Recovery Operation** tab of the Builder.

1. In the tree view shown in the left pane of the Builder, click the icon of the group to which the group resource you want to display or change whose behavior at the time when a group resource error is detected belongs.
2. The list of group resources will be shown in the table view on the right pane. Right-click the group resource you want to view or set whose behavior at the time when a group resource error is detected. Click **Properties**, and then click the **Recovery Operation** tab.
3. Specify the behavior at the time when a group resource error is detected by following the procedures below:

◆ When an error in activation of the group resource is detected:

When an error is detected while activating the group resource, try activating it again.

When the activation retry count exceeds the number of times set in **Retry Count at Activation Failure**, failover to the server specified in the **Failover Target Server** is executed.

When the group resource cannot be activated even after executing a failover as many times as specified in **Failover Threshold**, the final action is taken.

◆ When an error in deactivation of the group resource is detected:

When an error is detected while deactivating the group resource, try deactivating it again.

When the deactivation retry count exceeds the number of times set in **Retry Count at Deactivation Failure**, the final action is taken.

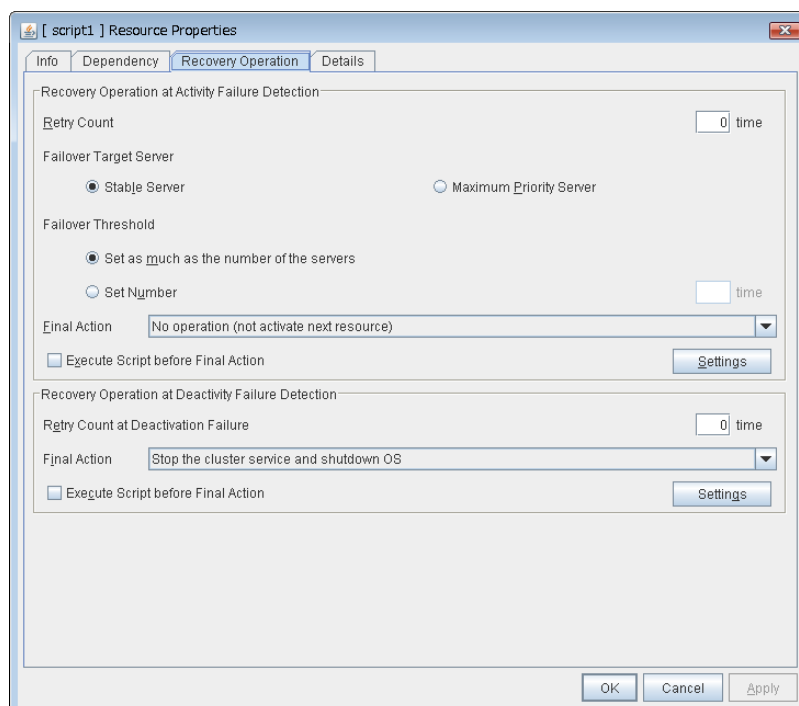

Recovery Operation at Activation Failure Detection

Retry Count (0 to 99) **SuspendResume**

Enter how many times to retry activation when an activation error is detected. If you set this to zero (0), the activation will not be retried.

Failover Target Server **SuspendResume**

Select a Failover Target Server for the failover that takes place after activation retries upon activation error detection have failed for the number of times specified in **Retry Count**.

- **Stable Server**
The failover destination is the server where least resource errors have been detected.
If two or more servers that meet the above condition exist, failover takes place by selecting one of them according to the failover policy of the group.
- **Maximum Priority Server**
Failover takes place according to the failover policy settings of the group.

Failover Threshold (0 to 99) **SuspendResume**

Enter how many times to retry failover after activation retry fails as many times as the number of times set in **Retry Count** when an error in activation is detected.

If you set this to zero (0), failover will not be executed.

- **Set as many as the number of the servers**
Set the failover threshold count to the number of servers.
- **Specify Number**
Specify any number for the failover threshold count.

Final Action **SuspendResume**

Select an action to be taken when activation retry failed the number of times specified in **Retry Count** and failover failed as many times as the number of times specified in **Failover Threshold** when an activation error is detected.

Select a final action from the following:

- No Operation (Activate next resource)
- No Operation (Not activate next resource)
- Stop Group
- Stop cluster service
- Stop cluster service and shutdown OS
- Stop cluster service and reboot OS
- Generating of intentional Stop Error

For details on the final action, see “Final action” on page 535.

Execute Script before Final Action

Select whether script is run or not before executing final action when an activation failure is detected.

- When the checkbox is selected:
A script/command is run before executing final action. To configure the script/command setting, click **Settings**.
- When the checkbox is not selected:
Any script/command is not run.

Recovery Operation at Deactivation Failure Detection

Retry Count at Deactivation Failure (0 to 99) **SuspendResume**

Enter how many times to retry deactivation when an error in deactivation is detected.

If you set this to zero (0), deactivation will not be retried.

Final Action **SuspendResume**

Select the action to be taken when deactivation retry failed the number of times specified in **Retry Count at Deactivation Failure** when an error in deactivation is detected.

Select the final action from the following:

- No Operation (Deactivate next resource)
- No Operation (Not deactivate next resource)
- Stop cluster service and shutdown OS
- Stop cluster service and reboot OS
- Generating of intentional Stop Error

For details on the final action, see “Final action” on page 535.

Note:

If you select **No Operation** as the final action when a deactivation error is detected, group does not stop but remains in the deactivation error status. Make sure not to set **No Operation** in the production environment.

Execute Script before Final Action

Select whether script is run or not before executing final action when a deactivation failure is detected.

- When the checkbox is selected:
A script/command is run before executing final action. To configure the script/command setting, click **Settings**.
- When the checkbox is not selected:
Any script/command is not run.

Displaying and changing the script when a group resource activation/deactivation failure is detected

You can display and change the setting of a script which is run before executing final action when a group resource failure is detected (when group resources are active/inactive) by using the **Recovery Operation** tab of the Builder.

1. In the tree view shown in the left pane of the Builder, click the icon of the group to which the group resource you want to view or set whose behavior at the time when a group resource activation/deactivation failure is detected belongs.
2. The list of group resources will be shown in the table view on the right pane. Right-click the group resource which you want to display or set whose behavior at the time when a group resource error is detected. Click **Properties**, and then click the **Recovery Operation** tab.
3. Click **Settings** in **Recovery Operation at Activation Failure Detection** or **Recovery Operation at Deactivation Failure Detection** to display the **Edit Script** dialog box. Set the script/command to be run before executing final action.

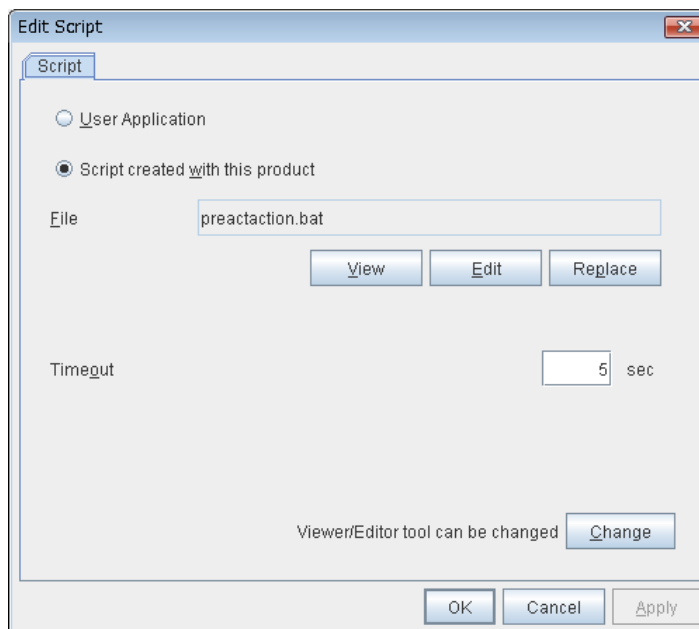

User Application

Use an executable file (executable batch file or execution file) on the server as a script. For the file name, specify an absolute path or name of the executable file of the local disk on the server. If you specify only the name of the executable file, you must configure the path with environment variable in advance. If there is any blank in the absolute path or the file name, put them in double quotation marks (“”) as follows.

Example:

“C:\Program Files\script.bat”

If you want to execute VBScript, enter a command and VBScript file name as follows.

Example:

cscript script.vbs

Each executable files is not included in the cluster configuration information of the Builder. They must be prepared on each server because they cannot be edited nor uploaded by the Builder.

Script created with this product

Use a script file which is prepared by the Builder as a script. You can edit the script file with the Builder if you need. The script file is included in the cluster configuration information.

File (Within 1023 bytes)

Specify a script to be executed (executable batch file or execution file) when you select **User Application**.

View

Click here to display the script file with an editor when you select **Script created with this product**. The information edited and stored with the editor is not applied. You cannot display the script file if it is currently displayed or edited.

Edit

Click here to edit the script file with the editor when you select **Script created with this product**. Overwrite the script file to apply the change. You cannot edit the script file if it is currently displayed or edited. You cannot modify the name of the script file.

Replace

Click here to replace the contents of a script file with the contents of the script file which you selected in the file selection dialog box when you select **Script created with this product**. You cannot replace the script file if it is currently displayed or edited. Select a script file only. Do not select binary files (applications), and so on.

Timeout (1 to 9999)

Specify the maximum time to wait for completion of script to be executed. The default value is set as 5.

Change

Click here to display the **Change Script Editor** dialog. You can change editor for displaying or editing a script to an arbitrary editor.

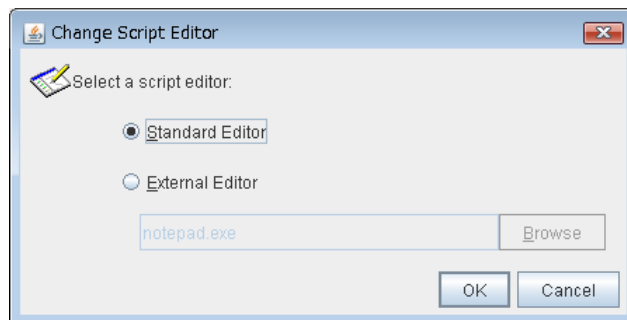

Standard Editor

Select here to use a standard editor (Notepad in Windows) as a script editor.

External Editor

Select here to specify an arbitrary script editor. Click **Browse** and specify the editor to be used.

Displaying the properties of a certain group by using the WebManager

1. Startup the WebManager (*http:// Management IP address or the IP address of the cluster server:port_number* (the default value is 29003)).
2. Click the object for a certain group  in the tree view. The following information is displayed in the list view.

Group Name: failover1		Details
Properties	Value	
Comment		
Status	Online	
Started Server	server1	
Resource Status		
appli1	Offline	
cifs1	Online	
fip1	Online	

Comment: Group comment
 Status: Group status
 Started Server The server name that the group has started now
 Resource Status The names and the status that the group has

Clicking **Details** also displays the following information in the popup dialog box:

Properties	Value
Name	failover1
Type	failover
Startup Attribute	Auto Startup
Failover Exclusive Attribute	No Exclusion
Failback Attribute	Manual Failback
Failover Attribute	Auto (Dynamic)
Servers that can run the Group	(1)server1 (2)server2

Name Group name
 Type: Group type
 Startup Attribute: Startup type of the group (auto/manual)
 Failover Exclusive Attribute: Startup exclusive attribute
 Failback Attribute: Failback attribute of the group (auto/manual)
 Failover Attribute: Failover attribute of the group (auto/manual)
 Servers that can run the Group: Order of the servers that the group failover

Understanding server groups

This section provides information about server groups.

Server groups are mainly groups of servers which are required when hybrid disk resources are used.

Upon using hybrid disk resources in a shared disk device, servers connected by the same shared disk device are configured as a server group.

Upon using hybrid disk resources in a non-shared disk, a single server is configured as a single server group.

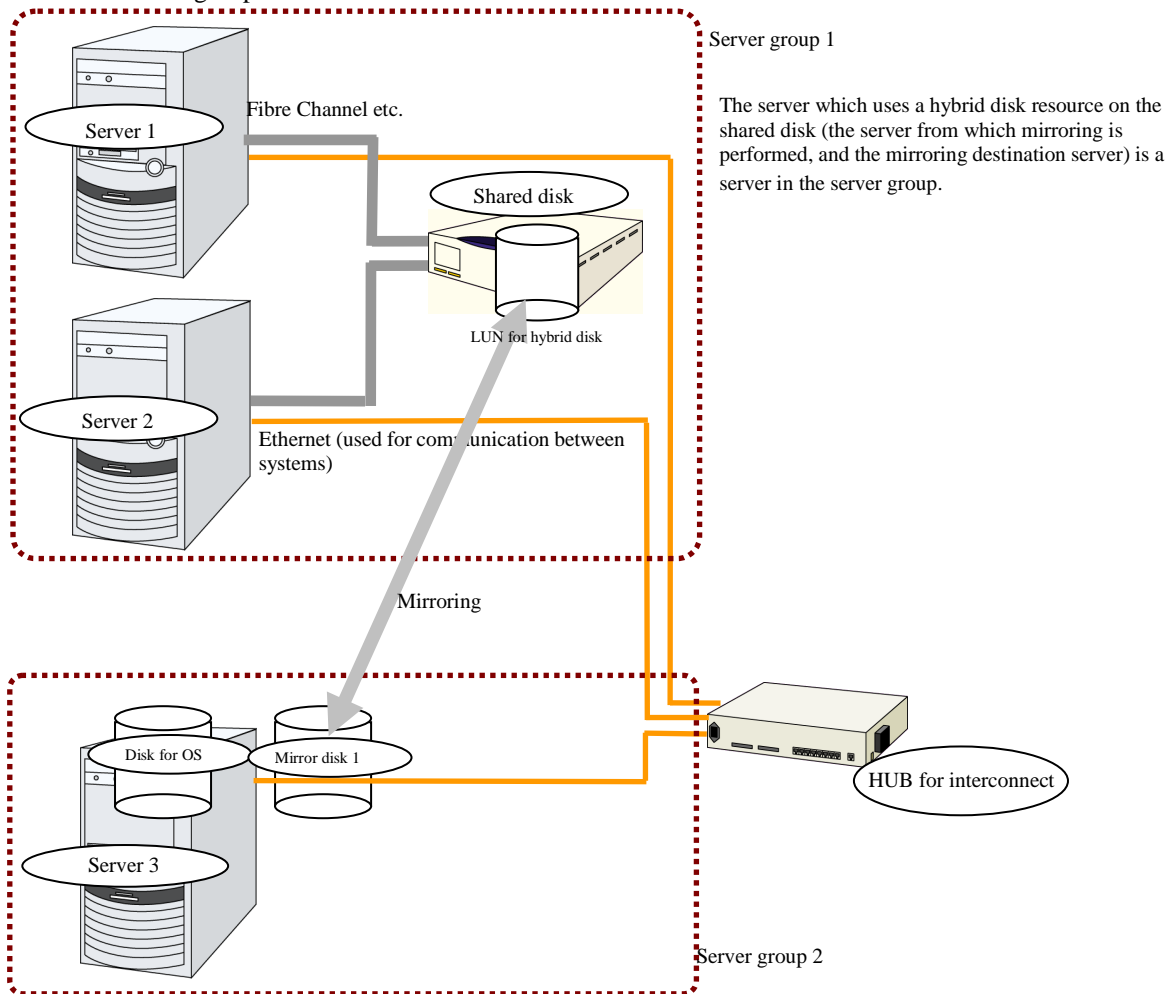

This figure omits public-LAN.

Displaying and changing the server group settings

You can display and change the settings of the server group by using **Server Group Definition** of the Builder.

Renaming a server group (Server group properties)

- In the tree view in the left pane of the Builder, right-click the **Servers** icon, and then click **Properties**.
- **Server Common Properties** is displayed. Click **Settings** in **Server Group**.
- **Sever Group** is displayed. Click **Rename**.
- The **Change Server Group Name** dialog box is displayed. Enter a new name.

Displaying and changing the comment of a server group (Server group properties)

1. In the tree view in the left pane of the Builder, right-click the **Servers** icon, and then click **Properties**.
2. **Server Common Properties** is displayed. Click **Settings** in **Server Group**.
3. **Sever Group** is displayed. Click **Properties**.
4. On the **Info** tab, the server group name and comment are displayed. Enter or modify the comment within 127 bytes.

Note:

You cannot change the server group name on the **Info** tab. To change the group name, see above “Renaming a server group (Server group properties).”

Displaying and changing the settings of servers belonging to a server group (Server group properties)

You can change the servers that belong to a server group.

1. In the tree view in the left pane of the Builder, right-click the **Servers** icon, and then click **Properties**.
2. **Server Common Properties** is displayed. Click **Settings** in **Server Group**.
3. **Sever Group** is displayed. Click **Rename**.
4. Click the **Server Group** tab. In **Servers that can run the Group**, servers that can start the group and their order are shown. The smaller the number, the higher priority the server has. In **Available Servers**, the servers that can be registered with **Servers that can run the Group** are shown.

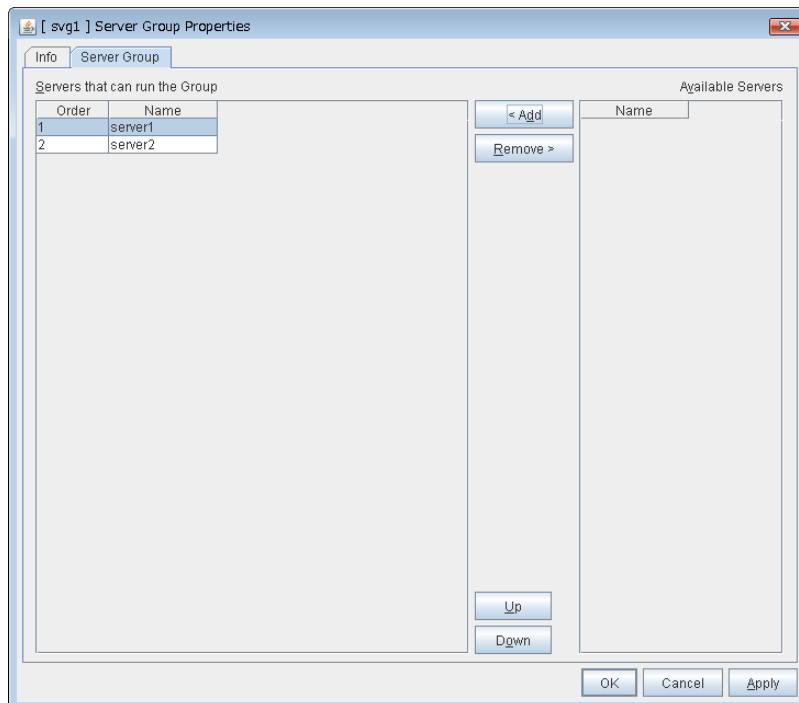

5. Configure the server group settings according to the following explanation.

Add

Use **Add** to add a server that can run the group. Select the server you want to add from **Available Servers** list and then click **Add**. The selected server is added to the **Servers that can run the Group**.

Remove

Use **Remove** to remove a server that can run the group. Select the server you want to remove from the **Servers that can run the Group** list and then click **Remove**. The selected server is added to **Available Servers**.

Up & Down

Use **Up** and **Down** to change the priority of a server that can run the group. Select the server whose priority you want to change, and then click **Up** or **Down**. The selected row moves accordingly.

Note: Make sure that the priority of the **Servers that can run the Group** consists with the failover policy of the failover group to which the resource using this server group belongs.

Displaying the server group properties with WebManager

1. Start the WebManager ([http:// Management IP address or the IP address of the cluster server:port number\(The default value is 29003\)](http://Management IP address or the IP address of the cluster server:port number(The default value is 29003))).
2. In the tree view, click the Servers object . Click **Server Group List** in the list view, the following is displayed on the popup dialog.

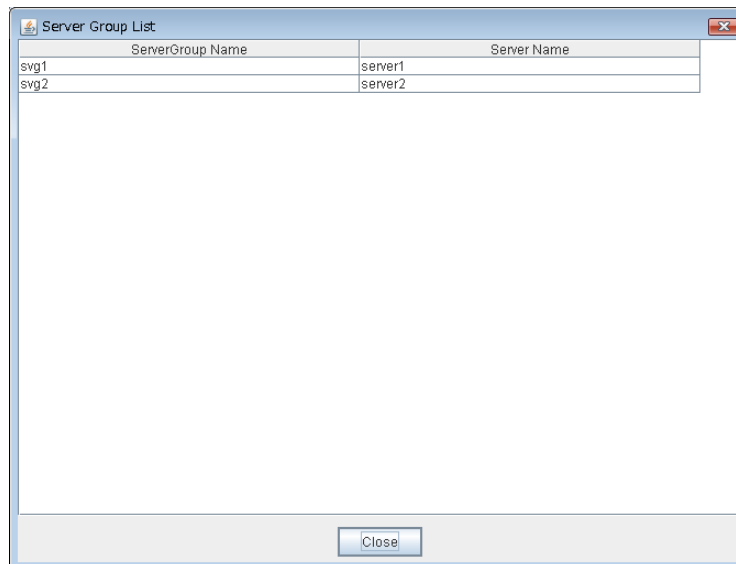

Server Group Name:

Server group name

Server Name:

Server names which belong to the server group

Understanding application resources

You can register applications managed by EXPRESSCLUSTER and executed when a groups in EXPRESSCLUSTER starts, stops, fails over or moves. It is also possible to register your own applications in application resources.

Dependency of application resources

By default, application resources depend on the following group resource types:

Group resource type
Floating IP resource
Virtual IP resource
Virtual computer name resource
Disk resource
Mirror disk resource
Hybrid disk resource
Print spooler resource
Registry synchronization resource
CIFS resource
NAS resource
AWS elastic ip resource
AWS virtual ip resource
Azure probe port resource

Application resources

Application resources are the programs that are executable from the command line by the files whose extension is exe, cmd, bat, or other.

Note on application resources

- ◆ An application to be run from application resources must be installed on all servers in failover and must have the same version.

Displaying and changing the application resource details

1. In the tree view shown on the left pane of the Builder, click the icon of the group to which the application resource whose detailed information you want to display or change belongs.
2. The list of group resources is displayed in the table view on the right pane of the screen. Right-click the name of the application resource that you want to display or change. Click **Properties**, and then click **Details** tab.
3. Display and/or change the settings by following the description below.

Resource Properties: Details tab

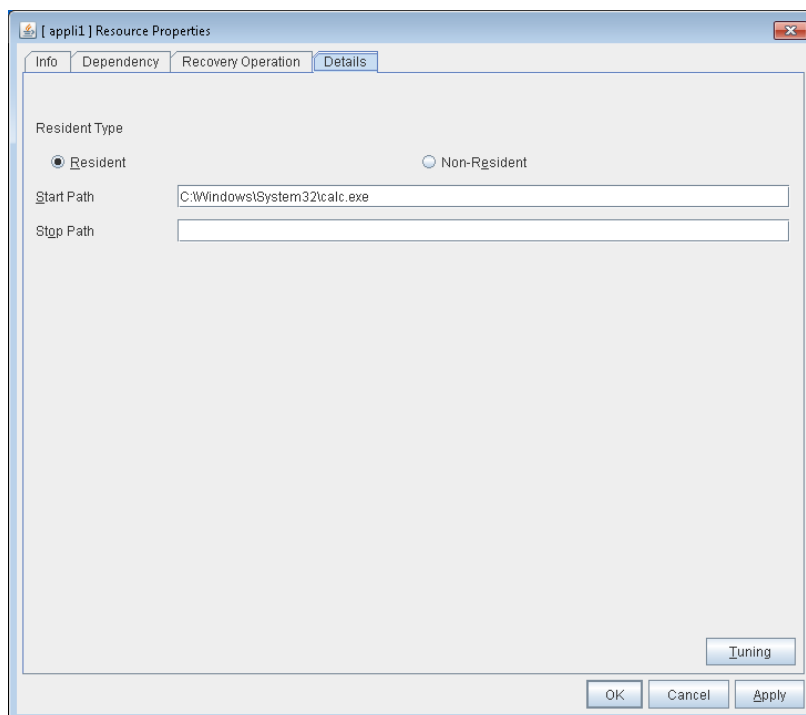

Resident Type **GroupStopRestart**

Specify the type of the application. Select one of the following:

- **Resident**
Select this when the application resides in EXPRESSCLUSTER.
- **Non-Resident**
Select this when the application does not reside (Process returns right after being executed) in EXPRESSCLUSTER.

Start Path Within 1023 bytes **GroupStopRestart**

Specify the name of the file that can be run when the application resource is started.

Stop Path Within 1023 bytes

Specify the name of the file that can be run when the application resource is stopped. The operation is as described below if the resident type is Resident.

- If the stop path is not specified
The application started by EXPRESSCLUSTER in the inactive state is stopped.
- If the stop path is not specified
The application started by executing the application specified for the stop path in the inactive state is stopped.

Note:

For the Start Path and Stop Path, specify an absolute path to the executable file or the name of the executable file of which the path configured with environment variable is effective. Do not specify a relative path. If it is specified, starting up the application resource may fail.

Tuning

Use this button to display the **Application Resource Tuning Properties** dialog box. Configure the detailed settings for the application resources.

Application Resource Tuning Properties

Parameter tab

Detailed parameter settings are displayed on this tab.

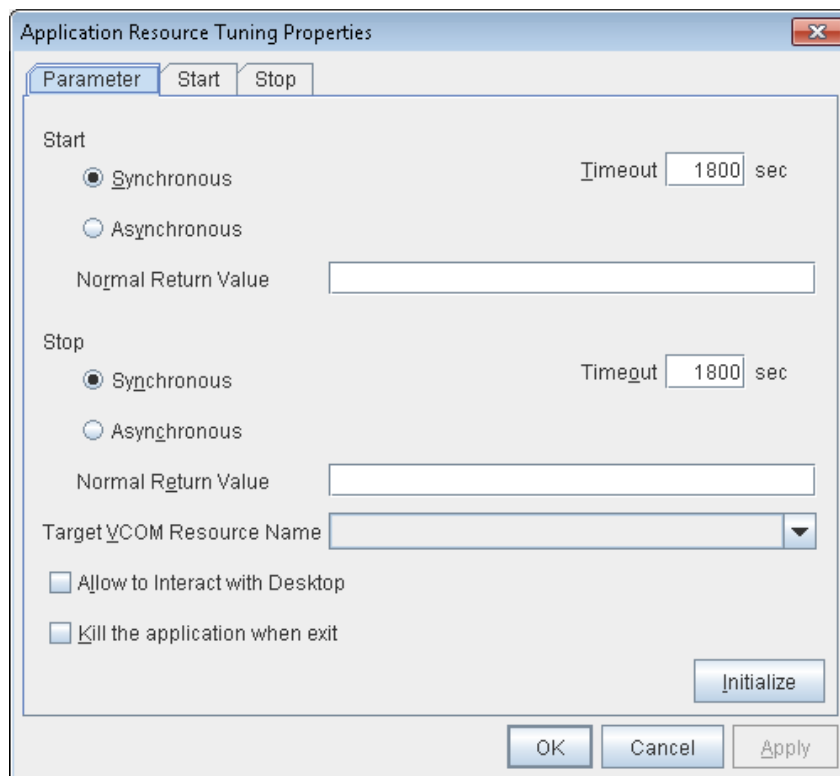

Synchronous (Start)

This setting is not available for a resident application.

If the application is non-resident, select this to wait for the application to stop when it is run.

Asynchronous (Start)

This setting is not available for a resident application.

If the application is non-resident, select this so as not to wait for the application to stop when it is run.

Normal Return Value (Start) (Within 1023 bytes)

This entry field cannot be entered when **Asynchronous** is selected.

Specify what error code returned from the executable file set by **Start Path** is normal when **Resident**

Type is **Non-resident**.

- ◆ When there is no value

The return value is ignored. This is the same operation as the X2.1 and earlier.

- ◆ When there is a value

Observe the following input rules.

- Values can be separated by commas (for example, 0, 2, 3).
- Values can be specified using a hyphen (for example, 0-3).

Note:

In case that a batch file is specified as the executable file, an error cannot be detected when 1 is specified as **Normal Return Value** because 1 is returned when an error occurs with cmd.exe which executes the batch file.

Synchronous (Stop)

If the application is resident, and the stop path is not specified, select this to wait for the currently running application to stop. If the application is resident, and the stop path is specified, select this to wait for the application specified for the stop path to stop.

If the application is non-resident, select this to wait for the application to stop when it is run.

Asynchronous (Stop)

If the application is resident, and the stop path is not specified, select this to wait for the currently running application to stop. If the application is resident, and the stop path is specified, select this to wait for the application specified for the stop path to stop.

If the application is non-resident, select this so as not to wait for the application to stop when it is run.

Normal Return Value (Stop) (Within 1023 bytes)

This entry field cannot be entered when **Asynchronous** is selected.

Specify what error code returned from the executable file set by **Stop Path** is normal when **Resident Type** is **Non-resident**.

- ◆ When there is no value

The return value is ignored. This is the same operation as the X2.1 and earlier.

- ◆ When there is a value

Observe the following input rules.

- Values can be separated by commas (for example, 0, 2, 3).
- Values can be specified using a hyphen (for example, 0-3).

Note:

In case that a batch file is specified as the executable file, an error cannot be detected when 1 is specified as **Normal Return Value** because 1 is returned when an error occurs with cmd.exe which executes the batch file.

Timeout (Start) (0 to 9999)

This setting is not available for a resident application.

Configure the timeout value to wait (synchronous) for a non-resident application to stop when the application is run. A value can be entered only when **Synchronous** is selected. If the application does not stop within the timeout value set here, it is considered as an error.

Timeout (Stop) (0 to 9999)

For a resident application, configure the timeout value to wait (**Synchronous**) for the currently running application or the application specified for the stop path to stop.

The timeout value can be set only when **Synchronous** is selected. If the application does not stop within the timeout value set here, it is considered as an error.

Target VCOM Resource Name `GroupStopRestart`

Select a virtual computer name used as a computer name for the application resource. Virtual computer names and resource names that exist in the failover group where the application resource belong to are listed.

When you specify this parameter, add the following environment variables and then start the application:

```
COMPUTERNAME=<virtual computer name>
_CLUSTER_NETWORK_FQDN_=<virtual computer name>
_CLUSTER_NETWORK_HOSTNAME_=<virtual computer name>
_CLUSTER_NETWORK_NAME_=<virtual computer name>
```

Allow to Interact with Desktop `GroupStopRestart`

Specify whether to allow the application to be run to interact with desktop. If this is selected, the application screen is displayed on the desktop when the application starts running. This setting is not available when an Exec User is specified on the **Start** and **Stop** tabs on Windows Server 2003.

Forcibly Terminate Application When Stopping

Specify whether or not to forcibly terminate the application as termination of deactivation. If this is selected, the application is forcibly terminated instead of normal termination. This is effective only when **Resident Type** is set to **Resident** and the stop path is not specified.

Initialize

Click **Initialize** to reset the values of all items to their default values.

Start and Stop tabs

A detailed setting for starting and stopping the application is displayed.

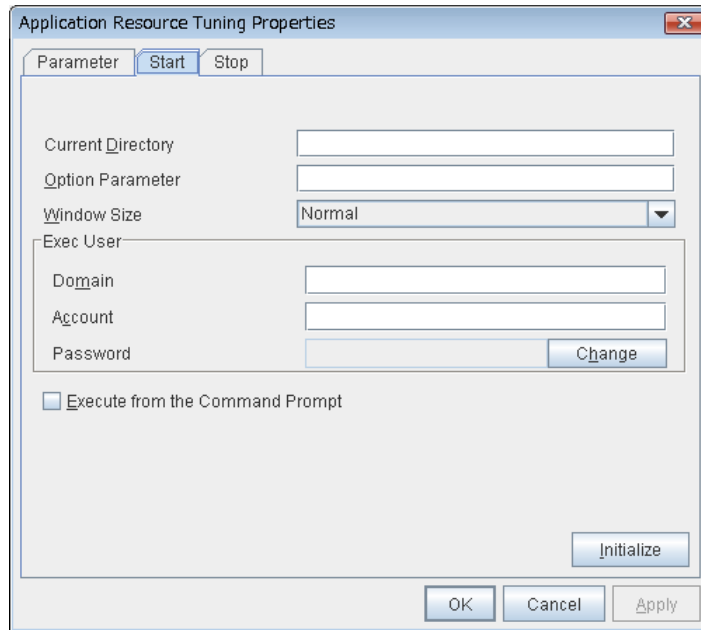

Current Directory Within 1023 bytes

Specify a directory for running the application.

Option Parameter Within 1023 bytes

Enter parameters to be entered for the application. If there are multiple parameters, delimit parameters with spaces. For a parameter that includes a space, enclose the parameter with double quotation marks.

Example: "param 1" param2

Window Size

Select the size of the window for running the application from the following:

- **Hide**

The application is not displayed.

- **Normal**

The application is displayed in a regular window size.

- **Maximize**

The application is displayed in a maximum window size.

- **Minimize**

The application is displayed in a minimum window size.

Exec User Domain (Within 255 bytes) **GroupStopRestart**

Specify the domain of a user account that runs the application.

In the case of **Stop** tab, it is unnecessary to stop and/or resume the group.

Exec User Account (Within 255 bytes) **GroupStopRestart**

Specify the user account that runs the application.¹

¹ When **Exec User Account** is left blank, the application is run by the local system account.
Section II Resource details

In the case of **Stop** tab, it is unnecessary to stop and/or resume the group.

Exec User Password (Within 255 bytes) **GroupStopRestart**

Specify the password for the user account that runs the application.

In the case of **Stop** tab, it is unnecessary to stop and/or resume the group.

Execute from the Command Prompt

Specify whether to run the application from the command prompt (cmd.exe). Specify this when running an application (such as JavaScript and VBScript) whose extension is other than exe, cmd, or bat.

Initialize

Click **Initialize** to reset the values of all items to their default values.

Displaying the application resource properties with the WebManager

1. Start the WebManager (*http://Management IP address or the IP address of the cluster server:port number* (the default value is 29003)).
2. Click an object for an application resource  in the tree view. The following information is displayed in the list view.

Application Name: appli1		Details
<div style="display: flex; border-bottom: 1px solid gray;"> Common server1 server2 </div>		
Properties	Value	
Comment		
Resident Type	Resident	
Start Path	notepad.exe	
[Start]Normal Return Value		
Stop Path		
[Stop]Normal Return Value		
Status	Online	
Started Server	server1	

- | | |
|------------------------------|--|
| Comment: | Comment on the application resource |
| Resident Type: | Resident type of the application resource |
| Start Path: | Start path of the application |
| [Start] Normal Return Value: | The return value from the execution file of the start path when it normally ended. |
| Stop Path: | Stop path of the application |
| [Stop] Normal Return Value: | The return value from the execution file of the stop path when it normally ended. |
| Status: | Status of the application resource |
| Started Server: | The server which the resource has started |

If you click **Details**, the following information is displayed.

Properties	Value
Name	appli1
Type	appli
Failover Target Server	Stable Server
Failover Threshold	Number of Servers
Retry Count at Activation Failure	0
Final Action at Activation Failure	No operation (not activate next resource)
Execute Script before Final Action	Off
Retry Count at Deactivation Failure	0
Final Action at Deactivation Failure	Stop the cluster service and shutdown OS
Execute Script before Final Action	Off
Dependent Resources	cifs1
Retry Interval at Activation Failure	5
Retry Interval at Inactivation Failure	5
Target VCOM Name	
[Start]Type	Synchronous
[Start]Timeout (seconds)	1800
[Start]Current Directory	
[Start]Option Parameter	
[Start]Window Size	Hide
[Start]Domain	
[Start]Account	
[Start]Allow To Interact With Desktop	Off
[Start]Execute From Command Prompt	Off
[Stop]Type	Synchronous
[Stop]Timeout (seconds)	1800
[Stop]Current Directory	
[Stop]Option Parameter	
[Stop]Window Size	Hide
[Stop]Domain	
[Stop]Account	
[Stop]Allow To Interact With Desktop	Off
[Stop]Execute From Command Prompt	Off
Process Termination	Off

Name:	Application resource name
Type:	Resource type
Failover Target Server:	Determination method of Failover Target Server
Failover Threshold:	The number of failovers to be made at detection of an error
Retry Count at Activation Failure:	The number of times activation is retried when an activation error is detected
Final Action at Activation Failure:	Final action at an activation error
Execute Script before Final Action:	Whether or not script is executed upon activation failure
Retry Count at Deactivation Failure:	The number of times deactivation is retried when a deactivation error is detected
Final Action at Deactivation Failure:	Final action at a deactivation error
Execute Script before Final Action:	Whether or not script is executed upon deactivation failure
Dependent Resources:	Dependent resources
Retry Interval at Activation Failure:	Activation retry interval
Retry Interval at Inactivation Failure:	Deactivation retry interval
Target VCOM Name:	VCOM name that the application uses
[Start]Type:	Execution type of Start application
[Start]Timeout (Second):	Timeout for Start application (seconds)
[Start]Current Directory:	Directory for Start application
[Start]Option Parameter:	Option parameter to be passed to Start application
[Start]Window Size:	Window size of the Start application
[Start]Domain:	Domain of the account that runs Start application
[Start]Account:	Account that runs Start application
[Start]Allow to Interact with Desktop:	Allow Start application to communicate with desktop
[Start]Execute from the Command Prompt:	Run Start application from the command prompt
[Stop]Type:	Execution type of Stop application
[Stop]Timeout(Second):	Timeout for Stop application (seconds)
[Stop]Current Directory:	Directory for Stop application

[Stop]Option Parameter:	Option parameter to be passed to Stop application
[Stop]Window Size:	Window size of the Stop application
[Stop]Domain:	Domain of the account that runs application
[Stop]Account:	Account that runs Stop application
[Stop]Allow to Interact with Desktop:	Allow Stop application to communicate with desktop
[Stop]Execute from the Command Prompt:	Run Stop application from the command prompt
Process Termination:	Whether or not to forcibly terminate process when stopping

Understanding floating IP resources

Dependencies of floating IP resources

By default, this function does not depend on any group resource type.

Floating IP

Client applications can use floating IP addresses to access cluster servers. By using floating IP addresses, clients do not need to be aware of switching access destination server when a failover occurs or moving a group migration.

Floating IP addresses can be used on the same LAN and over the remote LAN.

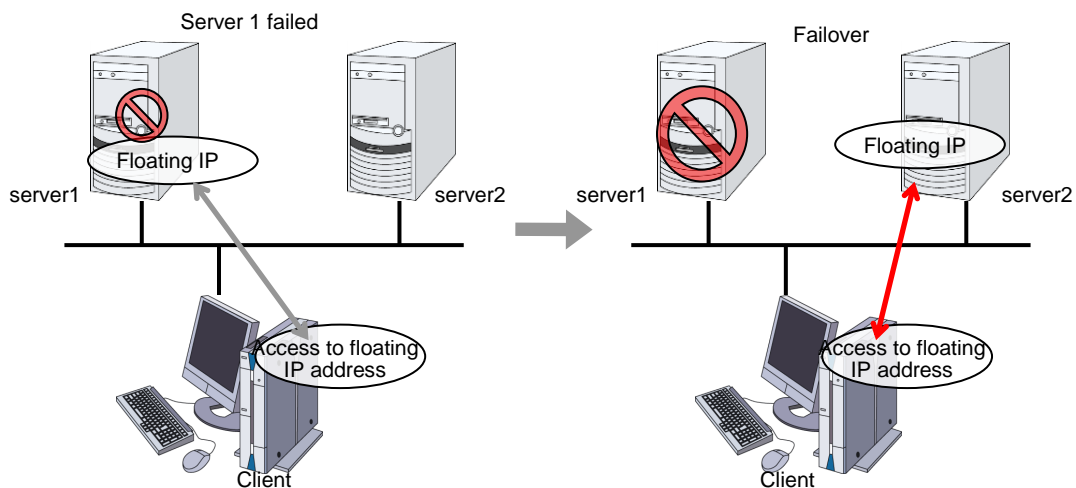

Address assignment

An IP address to assign for floating IP address needs to meet the condition described below:

- ◆ Available host address which is in the same network address as the LAN that the cluster server belongs

Allocate as many IP addresses that meet the above condition as required (generally as many as failover groups). These IP addresses are the same as general host addresses, therefore, you can assign global IP addresses such as Internet.

You can also allocate IPv6 addresses to floating IP addresses.

Switching method

For Windows Server 2008 or later, MAC addresses on the ARP table are switched by sending ARP broadcasting packets from the server on which floating IP resources are activated.

For Windows Server 2003 or earlier, ARP broadcasting packets are not sent to floating IP resources because a Windows OS function automatically sends ARP broadcasting packets.

A floating IP resource does not have the functionality to update ARP broadcasting packets periodically. Therefore, update the ARP table of a network device by using a custom monitor resource as required.

Routing

You do not need to make settings for the routing table.

Conditions to use

Floating IP addresses are accessible to the following machines:

- ◆ Cluster server itself
- ◆ Other servers in the same cluster and the servers in other clusters
- ◆ Clients on the same LAN as the cluster server and clients on remote LANs

If the following conditions are satisfied, machines other than the above can also access floating IP addresses. However, connection is not guaranteed for all models or architectures of machines. Test the connection thoroughly by yourself before using those machines.

- ◆ TCP/IP is used for the communication protocol.
- ◆ ARP protocol is supported.

Even over LANs configured with switching hubs, floating IP address mechanism works properly. When a server goes down, the TCP/IP connection the server is accessing will be disconnected.

Notes on floating IP resources

If the FIP is activated forcibly when there is an IP address overlap, the NIC is invalidated due to the Windows OS specifications. Therefore, do not use **Forced FIP Activation**.

Notes on allocating floating IP addresses to IPv4 addresses

- ◆ For Windows Server 2008, stopping the floating IP resource removes routing information. To avoid this phenomenon, specify an interface in the IF option when registering routing information as follows:

```
route -p add [destination] [Mask netmask] [gateway] [IF interface]
```

Notes on allocating floating IP addresses to IPv6 addresses

- ◆ IPv6 addresses should not be specified in Management Resources in Management Group.
- ◆ In the setting of virtual computer name resource, setting connection of floating IP resource assigned to IPv6 is invalid.
- ◆ When the floating IP address is set to perform to register in virtual computer name resource dynamically and it is selected to correspond to virtual computer name, the floating IP address cannot be allocated to IPv6 address.
- ◆ For Windows Server 2008, stopping the floating IP resource removes routing information. To avoid this phenomenon, specify an interface in the IF option when registering routing information as follows:

```
route -p add [destination] [Mask netmask] [gateway] [IF interface]
```

When a floating IP resource is set for a physical host, Windows registers the physical host name and FIP record in the DNS (if the property of the corresponding network adapter for registering addresses to the DNS is set to ON). To convert the IP address linked by the physical host name resolution into a physical IP address, set the relevant data as follows.

- Check the setting of the network adapter to which the corresponding floating IP address is assigned, by choosing **Properties - Internet Protocol Version 4 - Advanced - DNS** tab - **Register this connection's address in DNS**. If this check box is selected, clear it.
- Register the physical IP address of the network adapter to which the corresponding floating IP address is assigned to the DNS server statically.

When a floating IP resource adds a floating IP address to NIC by using a Windows OS API, the skipassource flag is not set and therefore does not take effect after activating a floating IP resource. Use applications such as PowerShell to set the skipassource flag after activating a floating IP resource.

- ◆ The floating IP resource cannot be used in a Network Load Balancing (NLB) environment.

Displaying and changing the details of floating IP resource

1. From the tree view displayed on the left pane of the Builder, click the icon of the group to which the floating IP resource whose detailed information you want to display and/or change belongs.
2. The group resource list is displayed in the table view in the right pane of the window. Right-click the desired floating IP resource name, click **Disk Resource Properties** and select the **Details** tab.
3. On the **Details** tab, you can see and/or change the settings by following the description below.

Floating IP Resource Properties: Details tab

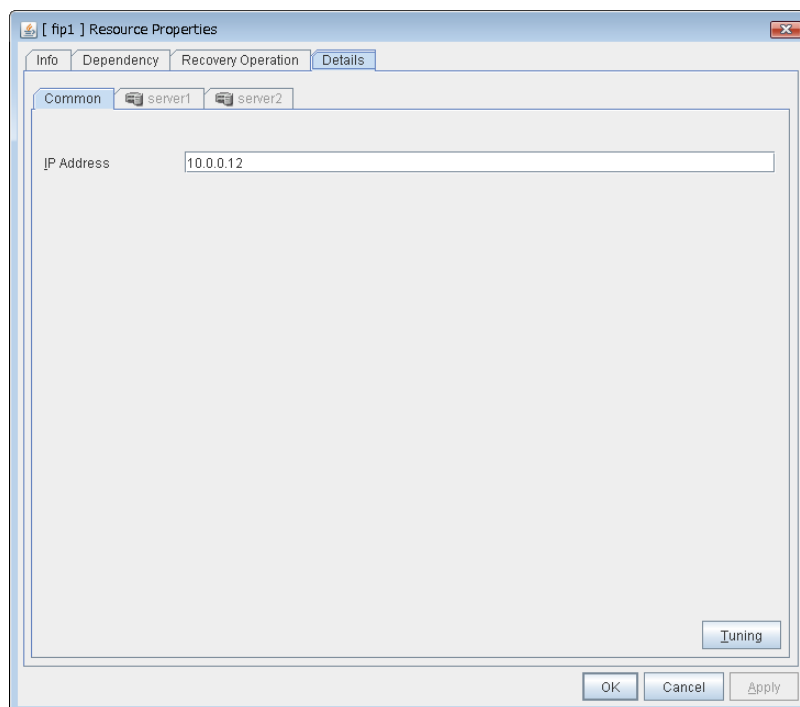

IP Address **GroupStopRestart**

Enter the floating IP address to be used.

If you specify an IPv4 address, the number of mask bits as 24 by default, find the address of the subnet mask on the local computer to match, you can add the floating IP address to the appropriate index.

Follow the instruction below to enter an IPv6 address.

Example: fe80::1

With the default value of prefix length 64 bit, floating IP resource searches for the addresses that have matching prefix on the local computer and adds floating IP address to the matching index. When there is more than one matching address, address is added to the index that has the largest index value.

In order to specify the prefix length explicitly, specify the prefix length after the address.

Example: fe80::1/8

In order to specify the index explicitly, specify %index after the address.

Example: fe80::1%5

The example above shows how to add a floating IP address to the index5.

Tuning

Opens the **Floating IP Resource Tuning Properties** dialog box where you can make detailed settings for the floating IP resource.

Server separate setting

Opens the **Server separate setting** dialog box. Floating IP address different depending on servers is set.

Floating IP Resource Tuning Properties

Detailed settings on floating IP resource are displayed.

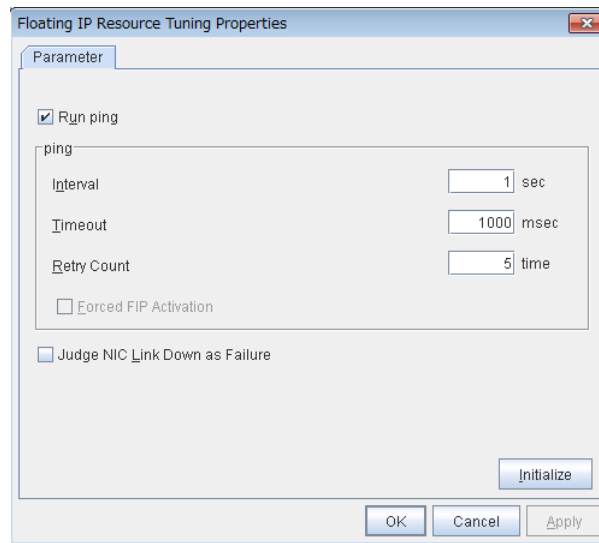

Run ping

Specify this to verify if there is any overlapped IP address before activating floating IP resource by using the ping command.

- ◆ When the checkbox is selected:
The ping command is used.
- ◆ When the checkbox is not selected:
The ping command is not used.

ping

These are the detailed settings of the ping command used to check if there is any overlapped IP address before activating floating IP resource.

- ◆ **Interval** (0 to 999)
Set the interval to issue the ping command in seconds.
- ◆ **Timeout** (1 to 999999)
Set timeout of the ping command in milliseconds.
- ◆ **Retry count** (0 to 999)
Set retry count of the ping command.
- ◆ **Forced FIP Activation**
Specify whether to forcibly activate floating IP address when an overlapped IP address is detected by command check. Be sure to set it to off.

- ◆ When the checkbox is selected:
Forced activation is performed.
- ◆ When the checkbox is not selected:
Forced activation is not performed.

NIC Link Down is treated as error

Specify whether to check for an NIC Link Down before the floating IP resource is activated.

- ◆ When the checkbox is selected:
In the case of an NIC Link Down, the floating IP resource is not activated.
- ◆ When the checkbox is not selected:
Even in the case of an NIC Link Down, the floating IP resource is activated. This operation is the same as before.

Initialize

Click **Initialize** to reset the values of all items to the default values.

Displaying the properties of floating IP resource with the WebManager

1. Start the WebManager (*http://Management IP address or the IP address of the cluster: port_number* (the default value is 29003)).
2. Click an object for a floating IP resource  in the tree view. The following information is displayed in the list view.

Floating IP Name: fip1		Details
Common server1 server2		
Properties	Value	
Comment		
IP Address	192.168.17.73	
Status	Online	
Started Server	server1	

Comment:	Comment
IP Address:	IP address used by floating IP resource
Status:	Status of floating IP resource
Started Server:	The server which the resource has started

If you click **Details**, the following information is displayed in the pop-up dialog.

Properties	Value
Name	fip1
Type	fip
Failover Target Server	Stable Server
Failover Threshold	Number of Servers
Retry Count at Activation Failure	5
Final Action at Activation Failure	No operation (not activate next resource)
Execute Script before Final Action	Off
Retry Count at Deactivation Failure	0
Final Action at Deactivation Failure	Stop the cluster service and shutdown OS
Execute Script before Final Action	Off
Dependent Resources	
Retry Interval at Activation Failure	5
Retry Interval at Inactivation Failure	5
Ping Execute	On
Ping Timeout (milliseconds)	1000
Ping Retry Threshold	5
Ping Retry Interval (seconds)	1
FIP Force Activation	Off
Send GARP Retry Threshold	3
Send GARP Retry Interval (seconds)	1

Name:	Floating IP resource name
Type:	Resource type
Failover Target Server:	Determination method of Failover Target Server
Failover Threshold:	The number of failovers to be made at detection of an error
Retry Count at Activation Failure:	The number of times activation is retried when an activation error is detected
Final Action at Activation Failure:	Final action at activation error
Execute Script before Final Action:	Whether or not script is executed upon activation failure
Retry Count at Deactivation Failure:	The number of times deactivation is retried when a deactivation error is detected
Final Action at Deactivation Failure:	Final action at deactivation error
Execute Script before Final Action:	Whether or not script is executed upon deactivation failure
Dependent Resources:	Dependent resource
Retry Interval at Activation Failure:	Activation retry interval
Retry Interval at Inactivation Failure:	Deactivation retry interval
Ping Execute:	Ping to verify redundancy
Ping Timeout (milliseconds):	Timeout of ping to confirm redundancy (in milliseconds)
Ping Retry Threshold:	Ping retry threshold count
Ping Retry Interval (seconds):	Ping retry interval (seconds)
FIP Force Activation:	Forced floating IP activation
Send GARP Retry Threshold:	Retry count of GARP send at activation
Send GARP Retry Interval (seconds):	Retry interval of GARP send at activation (seconds)

Understanding mirror disk resources

Dependencies of mirror disk resources

By default, this function does not depend on any group resource type.

Mirror disk

Mirror disks are a pair of disks that mirror disk data between two servers in a cluster.

Mirroring is performed by partition. It requires the RAW partition (cluster partition) to record the management data as well as the data partition that is to be mirrored. In addition, the license of EXPRESSCLUSTER X Replicator 3.3 for Windows is necessary on both servers that mirroring is performed.

The specifications of the disks need to be the same on both servers in order to use them as mirror disks.

Examples:

- ◆ Disk type and geometry

The size of the data partitions has to be completely the same by byte on both servers. If the disk size and geometry are different on each server, it may be unable to create partitions that are exactly the same size. Thus the geometry of disks which are used to secure data partitions needs to be the same on both servers.

It is recommended to use disks of the same model on both servers.

Example:

Combination	server1	server2
Correct	SCSI	SCSI
Correct	IDE	IDE
Incorrect	IDE	SCSI

Combination		Head	Sector	Cylinder
Correct	server1	240	63	15881
	server2	240	63	15881
Incorrect	server1	240	63	15881
	server2	120	63	31762

If it is not possible to make both servers have exactly the same disk type and geometry, check the size of data partitions in precise by using the `clpvolsz` command. If the disk size does not match, shrink the larger partition by using the `clpvolsz` command again.

For details on the `clpvolsz` command, see “Tuning partition size (`clpvolsz` command) in Chapter 3, “EXPRESSCLUSTER command reference” in this guide.

- ◆ Drive letter of partition

Configure the same drive letter for a data partition and cluster partition on both servers.

Example: Adding a SCSI disk to both servers to create a pair of mirroring disks.

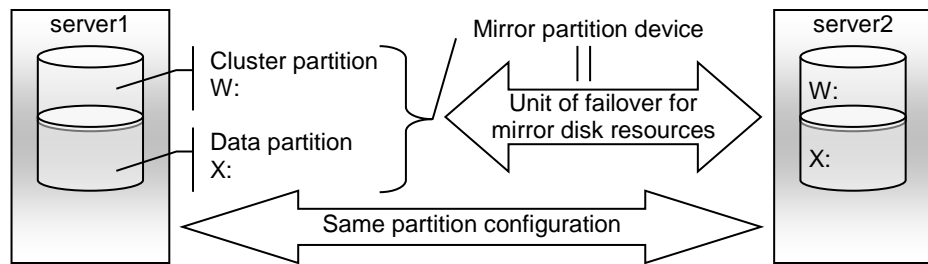

Example: Using available area of the IDE disk on which OS of both servers are stored to create a pair of mirroring disks.

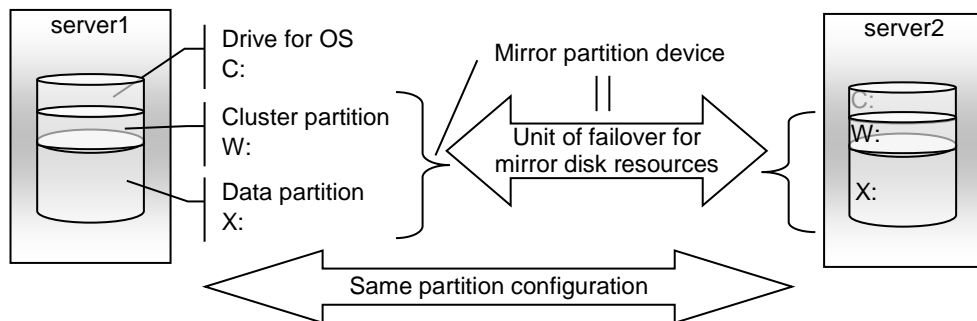

◆ A mirror partition (cluster partition, data partition) can be allocated on the same disk as OS.

- When the maintainability at occurrence of failure is important:
It is recommended to have another disk for a mirror than a disk for OS in advance.
- When a logical disk cannot be added because of the limitations of the hardware RAID specifications:
When it is difficult to change the configuration of a logical disk because hardware RAID is pre-installed:
A mirror partition (cluster partition, data partition) can be allocated on the same disk as OS.

◆ Disk allocation

One mirror disk resource can perform mirroring to only one partition. However, multiple partitions can be mirrored by creating multiple mirror disk resources.

It is possible to create multiple mirroring resources by allocating multiple data partitions and cluster partitions on a single disk.

Example: Adding one SCSI disk to both servers to create two pairs of mirroring disks.

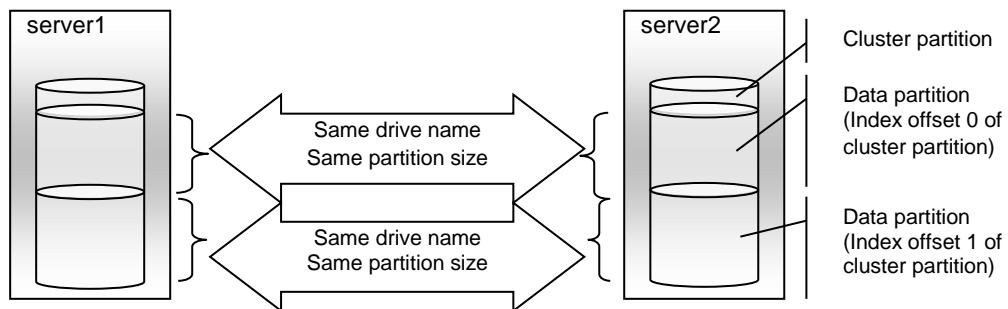

- Allocate a cluster partition and two data partitions in a pair on a single disk.
- Assign 0 and 1 for the offset index of the cluster partition management area to be used in each data partition.

Example: Adding two SCSI disks for both servers to create two mirroring partitions.

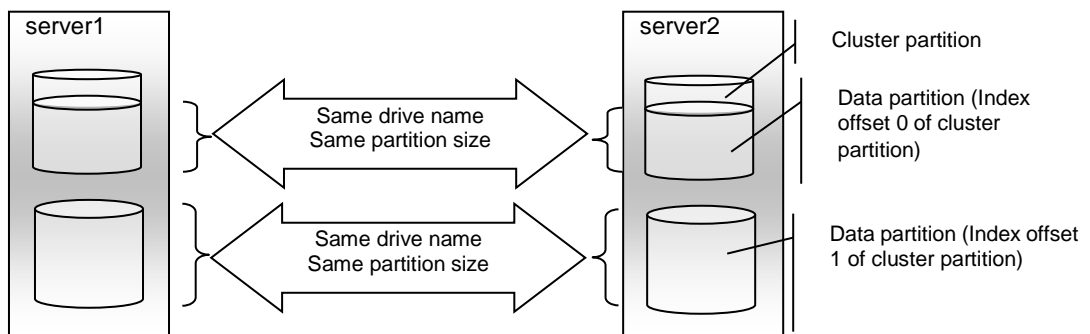

- Secure a cluster partition and data partition on the first disk and a data partition on the second disk.
- Routing and Remote Access Assign 0 and 1 for the offset index of the cluster partition management area to be used in each data partition.
- A cluster partition can be secured on each disk. In that case, the offset index is assigned to be 0 and 0.
- When performing mirroring in the asynchronous mode, an access to a cluster partition is generated in accordance with writing in a data partition. The access to a disk can be distributed by securing a cluster partition and data partition on separate disks.

Example: Adding one SCSI disk for three servers to create two mirroring partitions.

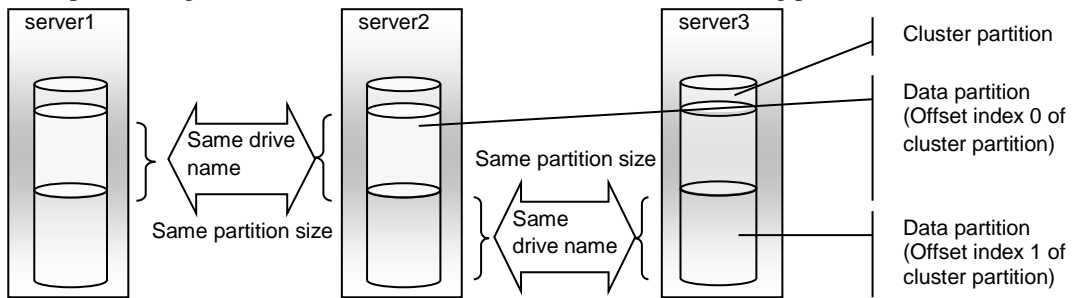

- Allocate a cluster partition and two data partitions on each server.
- On server2, the following two data partitions are required: One is used for mirroring with server1 while the other is used for mirroring with server3.
- Assign 0 and 1 as the offset index of the cluster partition management area to be used in each data partition.

Data partition

Partitions where data that is mirrored by EXPRESSCLUSTER (such as application data) is stored are referred to as data partitions. Allocate data partitions as follows:

- ◆ Data partition size
 - There is no limitation for partition size. Allocate any size of partition.
- ◆ Time required for data partition copying
 - When a file is copied at initial configuration or disk replacement, the required amount of time increases in proportion to the size of the volume use area. If the volume use area cannot be specified, the required amount of time increases in proportion to the data partition size because the entire area of the volume is copied.
- ◆ File system
 - Format the partition with NTFS. FAT/FAT32 is not supported.
- ◆ Allocate the partition on a basic disk. The dynamic disk is not supported.
- ◆ When making data partitions as logistical partitions on the extended partition, make sure the data partitions are logical partition on both servers. The actual size may be different even the same size is specified on both basic partition and logical partition
- ◆ The access to the data partition is controlled by EXPRESSCLUSTER.

Cluster partition

Dedicated partitions used in EXPRESSCLUSTER for mirror partition controlling are referred to as cluster partition.

Allocate cluster partitions as follows:

- ◆ Cluster partition size
 - 17 MB or more. Depending on the geometry, the size may be larger than 17 MB, but that is not a problem.
- ◆ A cluster partition and data partition for data mirroring should be allocated in a pair. If you use one cluster partition with multiple mirror disks, assign a different index number to each mirror disk so that the areas used in the cluster partition do not overlap each other.
- ◆ You do not need to make the file system on cluster partitions. Do not format.

- ◆ The access to a cluster partition is limited.

Access control of a data partition

The data partition to be mirrored by a mirror disk resource can be accessed only from the active server where a mirror disk resource is activated.

- ◆ EXPRESSCLUSTER is responsible for the access control of the file system. Application's accessibility to a data partition is the same as switching partition (disk resources) that uses shared disks.
- ◆ Mirror partition switching is done for each failover group according to the failover policy.
- ◆ By storing data required for applications on data partitions, the data can be automatically used after failing over or moving failover group.

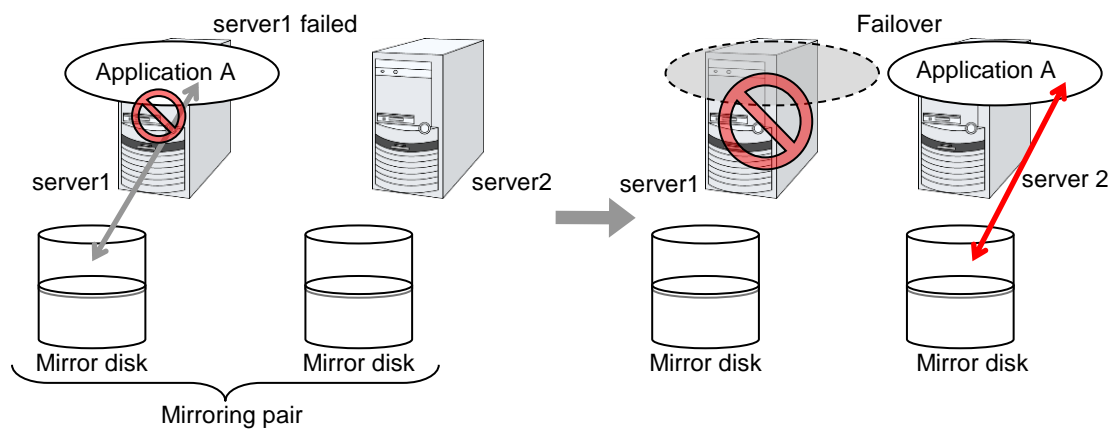

Understanding mirror parameters

The maximum size of request queues

Configure the size of queues which is used for the mirror disk driver to queue I/O requests on the communication among servers. If you select a larger value, the performance will improve but more memory will be required. If you select a smaller value, less memory will be used but the performance may be lowered.

Note the following when setting the number of queues:

- ◆ The improvement in the performance is expected when you set a larger value under the following conditions:
- ◆ Large amount of physical memory is installed on the server and there is plenty of available memory.
- ◆ The performance of the disk I/O is high.
- ◆ It is recommended to select a smaller value under the conditions:
- ◆ Small amount of physical memory is installed on the server.
- ◆ I/O performance of the disk is low.

Mirror Connect Timeout

This is the time required to cut a mirror connect when there is no response on the communication among servers and/or when the data synchronization has not completed at the time of mirror recovery and/or data synchronization. The time for timeout needs to be configured longer, if the line speed of the mirror connect is slow and/or the load to the mirror disk is high.

Adjust this parameter below the timeout value of heartbeat, based on the following calculation.

$$\text{Heartbeat timeout} = \text{Mirror connect timeout} + 10 \text{ seconds}$$

* For the settings of the heartbeat timeout, see “Cluster properties Timeout tab” in Chapter 2, “Functions of the Builder” in this guide.

Initial Mirror Construction

Specify if initial mirroring is configured when activating cluster for the first time after the cluster is created.

- ◆ Execute the initial mirror construction

An initial mirroring is configured (disk images of the data partition are fully copied) when activating cluster for the first time after the cluster is created.
- ◆ Do not execute initial mirror construction

Assume that data in the data partition has already matched among servers and do not configure initial mirroring at initial startup after constructing a cluster. When constructing a cluster, it is necessary to make the disk image of the data partition (physical data) identical without using EXPRESSCLUSTER.

Mode

Switch the synchronization mode of mirroring.

Mode	Overview	Explanation
Synchronous	Complete match of the data in the active and standby servers is guaranteed.	Writing the data to the mirrored disk is finished when writing the data to both local and remote disks is finished.
Asynchronous	The order to write in the updated data is guaranteed. However, the latest updated data may be lost, if a failover is performed in the state that a mirror disk resource cannot be deactivated as servers are down.	<p>Writing the data to the mirrored disk is finished when writing the data to the local disk is finished.</p> <p>The data is transferred to the remote disk after writing request is queued and performed on the background.</p> <p>After queuing is kept in the kernel space memory, it is transferred to the user space memory. When the volume of data reaches a limit that the user space memory can keep, the data is sent out to a temporary file and kept there.</p>

Kernel Queue Size

Specify the size of the request for writing to the remote disk to be kept in the kernel space memory when the mode is set to **Asynchronous**. Normally, default value is specified.

Input and output are completed, if writing data can be saved in the kernel queue.

If taking data into the application queue is delayed as the load on CPU is high, the size is set larger. However, if the size is too large, it will result in compressing the system resource.

Application Queue Size

Specify the size of the request for writing to the remote disk to be kept in the user space memory when the mode is set to **Asynchronous**. Normally, the default value is used. However, if a high-speed network is used, the frequency of creating a temporary file can be reduced and the overhead caused by input and output can be decreased by making the queue size larger.

Upper Bound of Communication Band

When the mode is **Asynchronous**, the server tries to transfer data that has been queued to the standby server. When the channel for mirror connection is used for connections for other applications, the communication band may become busy. In this case, by setting the bound of communication band for the mirror connect communication, the impact on other communications can be reduced. If the communication band for mirror connect is smaller than the average amount of data to be written into the mirror disk, the queued data cannot be fully transferred to the standby server, which can result in overflow and suspension of mirroring. The bandwidth should be large enough for data to be written into the business application.

This function makes a limit to the communication band by having a maximum of one-second pause when the total amount of data to be transferred per second exceeds the configured value. If the size of data to be written into the disk at a time is greater than the configured value, expected performance may not be achieved. For example, even if you set the value of communication band limit to be 64Kbyte or smaller, the actual amount of communication during copy can be greater than the configured value because the size of data to be transferred for a copy of a mirror disk at a time is 64 Kbyte.

Related Information:

In addition to the limit on the communication band for each mirror disk resource, you can also set a limit on the communication band for each mirror disk connect by using a standard Windows function. For details, see "Limit on the band for mirror connect communication" in Chapter 10, "The system maintenance information" in this guide.

History Files Store Folder

Specify the folder that keeps the temporary file which is created when the request for writing to the remote disk in the **Asynchronous** mode cannot be recorded in the application queue. When the communication band runs short, data is recorded up to the limit of the disk space if the limit of the history file size is not specified. Thus, specifying a folder on the system disk runs out of the empty space and the system behavior may become unstable. Therefore, if you want to suspend mirroring when recording data is exceeded a certain size, create a dedicated partition or specify the limit of the history file size.

Do not specify any folder on the cluster partition and data partition to the history files store folder. Also, do not specify a folder containing a 2-byte character in the path.

Thread Timeout

This is the time that timeout is occurred when data cannot be transferred to the application queue from the kernel queue in the mode of **Asynchronous**. When it is timed out, a mirror connect is cut.

Timeout may occur, if the data transfer to the application queue is delayed due to high load. In this case, increase the timeout value.

Examples of mirror disk construction

- ◆ Execute the initial mirror construction

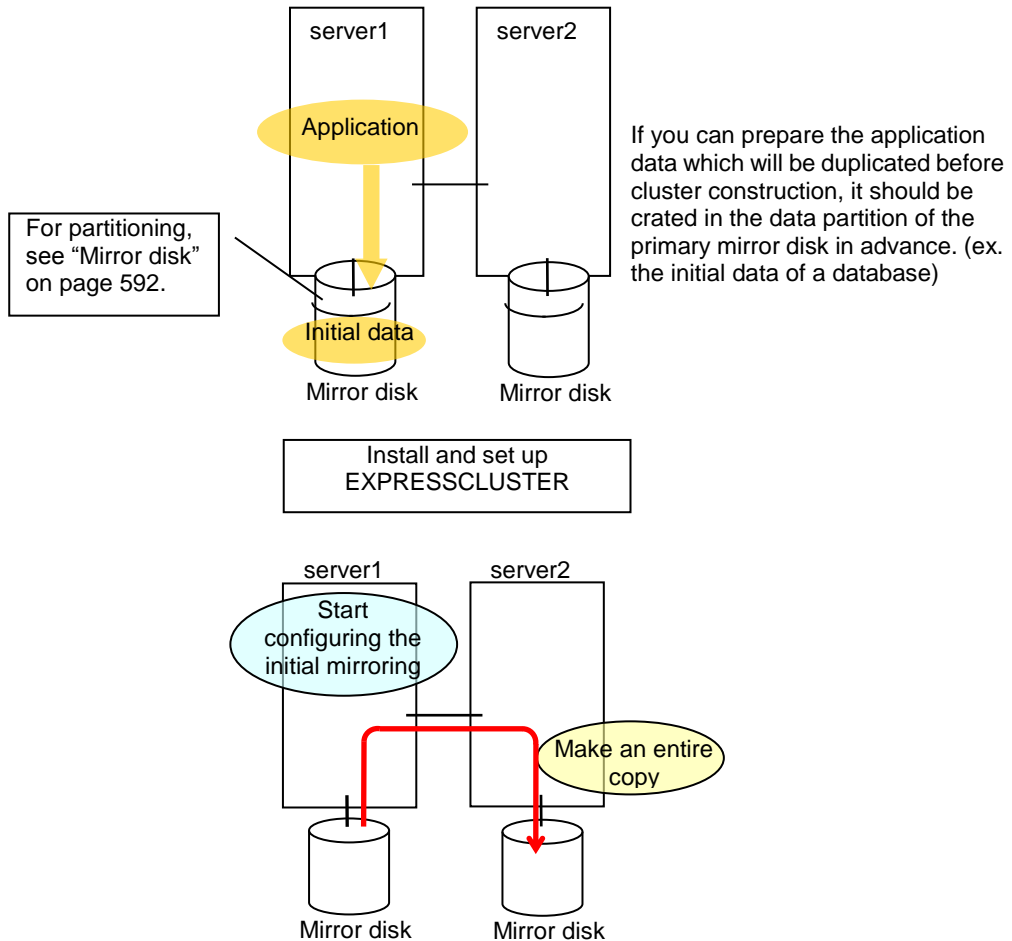

- ◆ Do not execute the initial mirror construction

Follow the procedures below to have identical data in the data partition on both servers:

1. If application data to be duplicated can be prepared before configuring a cluster, create it on data partition of the mirror disk on the active server in advance (ex. initial data of the database).
2. Install EXPRESSCLUSTER and configure a cluster without executing the initial mirror construction.
3. Shut down the cluster.
4. Remove disks that have data partitions on both servers, and connect to the Linux server. Then copy the data in the data partition on the active server to the data partition on the standby server by using the `dd` command in the state that disks are not mounted.
5. Return disks to the active and standby server and start both servers.

Notes on mirror disk resources

Set both servers so that the identical partitions can be accessed under the identical drive letter.

If a drive letter different from those used on partition is set, the drive letter will be changed when the mirror disk resource is started. If the drive letter is used on any other partitions, starting up the mirror disk resource will fail.

To change the configuration so that the disk mirrored using a hybrid disk resource will be mirrored using a mirror disk resource, first delete the existing hybrid disk resource from the configuration data, and then upload the data. Next, add a mirror disk resource to the configuration data, and then upload it again.

- For the data partition and the cluster partition of hybrid disk resources, use disk devices with the same logical sector size on all servers. If you use devices with different logical sector sizes, they do not operate normally. They can operate even if they have different sizes for the data partition and the cluster partition.
 - Examples)

Combination	Logical sector size of the partition				Description
	Server 1		Server 2		
	Data partition	Cluster partition	Data partition	Cluster partition	
OK	512B	512B	512B	512B	The logical sector sizes are uniform.
OK	4KB	512B	4KB	512B	The data partitions have a uniform size of 4 KB, and the cluster partitions have a uniform size of 512 bytes.
NG	4KB	512B	512B	512B	The logical sector sizes for the data partitions are not uniform.
NG	4KB	4KB	4KB	512B	The logical sector sizes for the cluster partitions are not uniform.

Displaying and changing the details of mirror disk resources

1. From the tree view displayed on the left pane of the Builder, click the icon of the group to which the mirror disk resource whose detailed information and settings you want to display and/or change belongs.
2. The group resource list is displayed on the table view in the right pane of the window. Right-click the desired mirror disk resource name, and click **Properties** on the shortcut menu. In the properties dialog box, click the **Details** tab.
3. Display and/or change the detailed settings on the **Details** tab as described below.

Mirror Disk Resource: Details tab

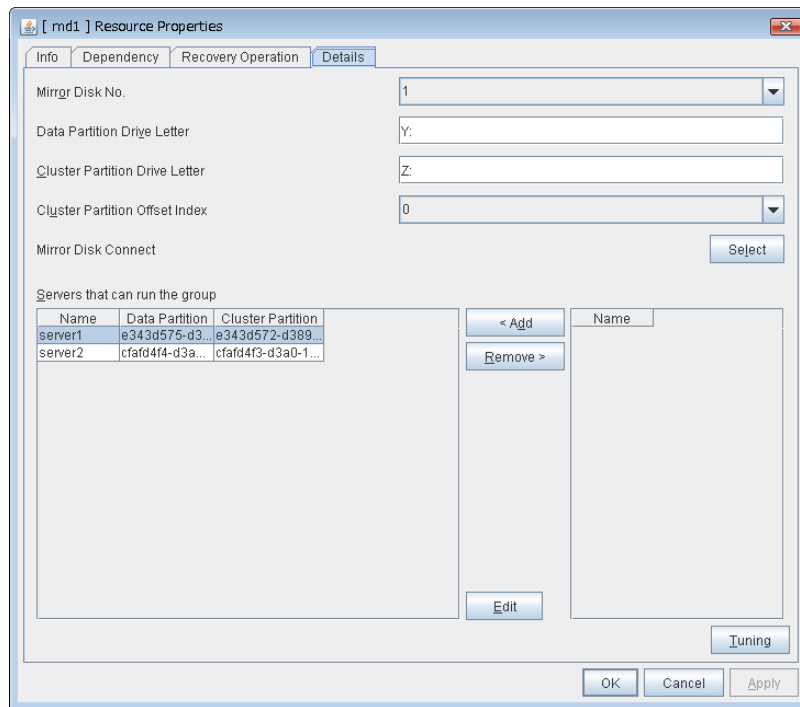

Mirror Disk No. **SuspendResume** **GroupStopRestart**

Select the number to be allocated to the mirror partition.

Data Partition Drive Letter (Within 1023 bytes) **SuspendResume** **GroupStopRestart**

Specify the drive letter (A to Z) of the data partition.

Cluster Partition Drive Letter (Within 1023 bytes) **SuspendResume** **GroupStopRestart**

Specify the drive letter (A to Z) to the cluster partition.

Cluster Partition Offset Index **SuspendResume** **GroupStopRestart**

Select an index number for the area used in the cluster partition. When using the multiple mirror disks, assign different numbers for each mirror disk so that the areas to be used in the cluster partition are not overlapped.

Select ShutdownReboot

Select the communication path for the data mirroring communication (mirror disk connect). Click **Select** to display the **Selection of Mirror Disk Connect** dialog box.

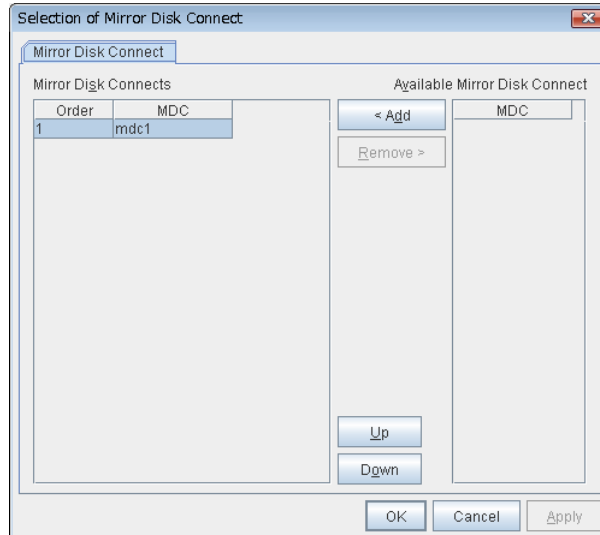

- ◆ **Add**
Use **Add** to add mirror disk connects. Select the mirror disk connect you want to add from **Available Mirror Disk Connect** and then click **Add**. The selected mirror disk connect is added to the **Mirror Disk Connects**.
- ◆ **Remove**
Use **Remove** to remove mirror disk connects to be used. Select the mirror disk connect you want to remove from the **Mirror Disk Connects** and then click **Remove**. The selected mirror disk connect is added to **Available Mirror Disk Connect**.
- ◆ **Up, Down**
Use **Up** and **Down** to change the priority of mirror disk connects to be used. Select the mirror disk connect whose priority you want to change, and then click **Up** or **Down**. The selected row moves accordingly.

For mirror disk connect settings, see “Cluster properties Interconnect tab” in Chapter 2, “Functions of the Builder” in this guide.

Add `ShutdownReboot`

Click this button to add the selected server to **Servers that can run the group**. When this button is clicked, the dialog box that allows for selection of a partition of the selected server is displayed.

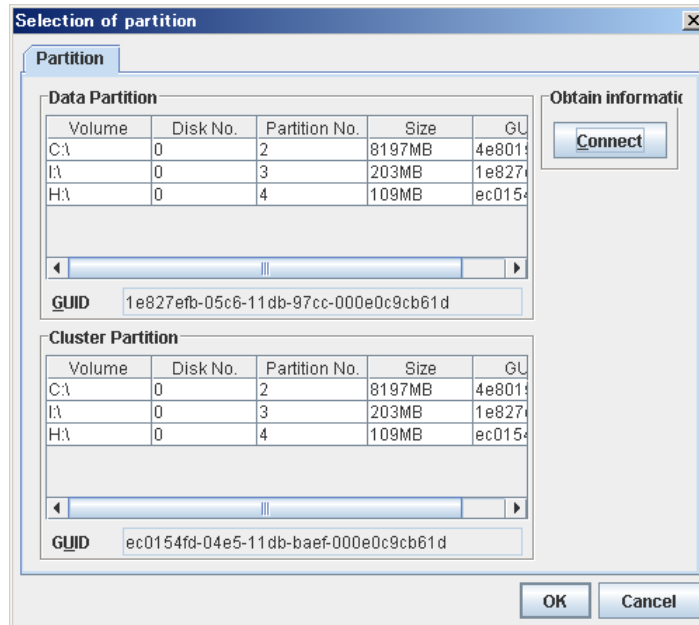

- ◆ **Data Partition**
Select a partition to be used as a data partition from the list. The GUID of the selected data partition is displayed.
- ◆ **Cluster Partition**
Select a partition to be used as a cluster partition from the list. The GUID of the selected cluster partition is displayed.
- ◆ **Connect**
Use this button to connect to the server and obtain the list of partitions.

Important:

Specify different partitions for data partition and cluster partition. If the same partition is specified, data on the mirror disk may be corrupted. Make sure not to specify the partition on the shared disk for the data partition and cluster partition.

Remove `ShutdownReboot`

Use this button to delete a server from **Servers that can run the group**.

Edit `SuspendResume` `GroupStopRestart`

Use this button to display the dialog box to select the partition of the selected server.

Tuning

Opens the **Mirror Disk Resource Tuning Properties** dialog box. You make detailed settings for the mirror disk resource there.

Tuning mirror disk resource

1. From the tree view displayed on the left pane of the Builder, click the icon of the group to which the mirror disk resource whose detailed information and settings you want to display and/or change belongs.
2. The group resource list is displayed on the table view in the right pane of the window. Right-click the desired mirror disk resource name, click **Properties** on the shortcut menu. In the properties dialog box, click the **Details** tab.
3. On the **Details** tab, click **Tuning** to display the **Mirror Disk Resource Tuning Properties** dialog box. Display and/or change the detailed settings as described below.

Mirror tab

The advanced settings of mirror are displayed.

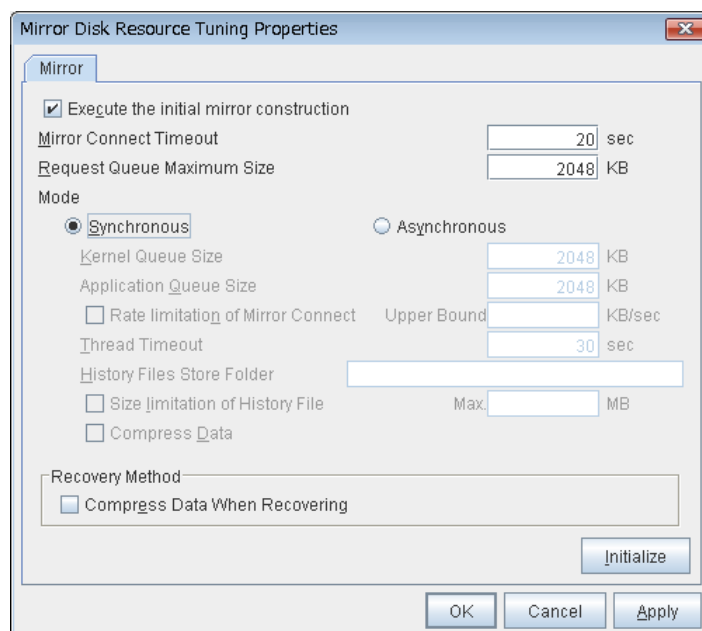

Execute the initial mirror construction **SuspendResume** **GroupStopRestart**

Specify whether to execute an initial mirror construction (full copy of data partition) when configuring a cluster.

- ◆ When the checkbox is selected:
Execute an initial mirror construction. In general, specify this.
- ◆ When the checkbox is not selected:
Handle as it is configured without executing an initial mirror construction. Specify this if the data partition contents are already the same and full copying is not required.

Mirror Connect Timeout (2 to 9999) **SuspendResume** **GroupStopRestart**

Specify the timeout for mirror connect.

Request Queue Maximum Size (512 to 65535) **SuspendResume** **GroupStopRestart**

Specify the size of queue that a mirror disk driver uses to queue I/O requests on the communication among servers.

Mode **SuspendResume** **GroupStopRestart**

Switch the mode of the mirror data synchronization.

- ◆ Synchronous
Write in the local disk and remote disk simultaneously to queue the completion.
- ◆ Asynchronous
After writing in the local disk, write in the remote disk. Queue for the completion of writing in the local disk.

Kernel Queue Size (512 to 65535) **SuspendResume** **GroupStopRestart**

Specify the queue size of the kernel space to save the I/O data of the asynchronous mirror temporarily.

Application Queue Size (512 to 65535) **SuspendResume** **GroupStopRestart**

Specify the queue size of the user space to save the I/O data of the asynchronous mirror temporarily.

Rate limitation of Mirror Connect (0 to 999999999) **SuspendResume** **GroupStopRestart**

Set the upper limit of the communication band used by the mirror connect.

Thread Timeout (2 to 999) **SuspendResume** **GroupStopRestart**

Specify the timeout when it becomes unable to transfer from the kernel queue to the application queue.

History Files Store Folder (Within 256 bytes) **SuspendResume** **GroupStopRestart**

Specify the destination folder to store the file when I/O data is overflowed from the application queue. It is required to specify a folder that has sufficient free space so that the remote disk and the asynchronous I/O data can be kept as a file.

Do not specify any folder in the cluster partition and data partition to the history files store folder. Additionally do not specify a folder that contains two byte characters in the path.

Size limitation of History File (0 to 999999999) **SuspendResume** **GroupStopRestart**

Set the size limit of temporary files stored in the history file store folder. If the upper limit of size is specified, mirroring will stop when the total amount of this temporary file reaches the limit. The configured value is only applied to the limit of the temporary file size for the mirror disk resources, and this value does not set the limit of the amount of the temporary files in the history file store folder.

Compress data **ShutdownReboot**

Specify whether to compress the mirror data flowing through the mirror disk connect.

Compress Data When Recovering **ShutdownReboot**

Specify whether to compress the mirror data flowing through the mirror disk connect for the purpose of mirror recovery.

Initialize

Click **Initialize** to reset the values of all items to their default values.

Displaying the mirror disk resource properties with the WebManager

1. Start the WebManager (http://Management IP address or the IP address of the cluster: port_number (the default value is 29003)).
2. Click an object for a mirror disk resource  in the tree view. The following information is displayed in the list view.

Mirror Disk Name: md1		Details
<div style="display: flex; justify-content: space-between;"> Common server1 server2 </div>		
Properties	Value	
Comment		
Mirror Disk No.	1	
Drive Letter	M:	
Mirror Disk Connect	mdc1	
	mdc2	
Status	Online	
Started Server	server1	

- | | |
|----------------------|--|
| Comment: | Mirror disk resource comment |
| Mirror Disk No.: | Mirror disk number allocated to the mirror partition |
| Drive Letter: | Drive letters of the data partition |
| Mirror Disk Connect: | Mirror disk connect name of the communication path for mirroring |
| Status: | Status of the mirror disk resource |
| Started Server: | The server which the resource has started |

If you click **Details**, the following information is displayed in the pop-up dialog.

Properties	Value
Name	md1
Type	md
Failover Target Server	Stable Server
Failover Threshold	Number of Servers
Retry Count at Activation Failure	3
Final Action at Activation Failure	No operation (not activate next resource)
Execute Script before Final Action	Off
Retry Count at Deactivation Failure	0
Final Action at Deactivation Failure	Stop the cluster service and shutdown OS
Execute Script before Final Action	Off
Dependent Resources	
Retry Interval at Activation Failure	5
Retry Interval at Inactivation Failure	5
Cluster Partition - Drive Letter	L:
Cluster Partition - Offset Index	0
Initial Mirror Construction	On
Mode	Synchronous
Max. Number of Request Queues(KB)	2048
Mirror Connect Timeout(sec)	20
Asynchronous - History Files Store Folder	
Asynchronous - Kernel Queue Size(KB)	2048
Asynchronous - Application Queue Size(KB)	2048
Asynchronous - Thread Timeout(sec)	30
Asynchronous - Max. Size of History File(MB)	Unlimited
Asynchronous - Upper Bound of Communication Band(KB/sec)	Unlimited
Compress Data	No

- | | |
|-------|---------------------------|
| Name: | Mirror disk resource name |
| Type: | Resource type |

Failover Target Server:	Determination method of Failover Target Server
Failover Threshold:	The number of failovers to be made at detection of an error
Retry Count at Activation Failure:	The number of times activation is retried when an activation error is detected
Final Action at Activation Failure:	Final action at an activation error
Execute Script before Final Action:	Whether or not script is executed upon activation failure
Retry Count at Deactivation Failure:	The number of times deactivation is retried when a deactivation error is detected
Final Action at Deactivation Failure:	Final action at deactivation error
Execute Script before Final Action:	Whether or not script is executed upon deactivation failure
Dependent Resources:	Dependent resource
Retry Interval at Activation Failure :	Interval to perform activation retry when an activation error is detected
Retry Interval at Inactivation Failure:	Interval to perform inactivation retry when an activation error is detected.
Cluster Partition:	
Cluster Partition Drive Letter:	Drive letters of the cluster partition
Cluster Partition Offset Index:	Index number for the area to be used for cluster partition
Initial Mirror Construction:	Whether to execute an initial mirror construction when configuring a cluster
Mode:	Synchronization mode of the mirror data
Max. Number of Request Queues (KB):	Size of queue for the mirror disk drive to queue I/O requests on the communication among servers (KB)
Mirror Connect Timeout (Second):	Time until mirror connect is cut when there is no response on the communication among servers and the data synchronization has not completed at the time of mirror recovery and data synchronization (seconds)
Asynchronous:	
History Files Store Folder:	Folder to keep the writing requests to the remote disk in files
Kernel Queue Size (KB):	Size to keep the writing request to the remote disk in the kernel space memory (KB)
Application Queue Size (KB):	Size to keep the writing request to the remote disk in the user space memory (KB)
Thread Timeout:	Timeout when it became unable to transfer data form the kernel queue to the application queue
Max. Size of History File (MB):	Upper limit of amount of files stored in history files store folder (MB)
Upper Bound of Communication Band (KB/sec.):	Upper limit of communication band on Mirror Connect (KB/sec.)
Compress Data:	Whether or not to compress the mirror data flowing through the mirror disk connect

Notes on operating mirror disk resources

If mirror data was synchronized on both servers when the cluster was shut down, use one of the two orders noted below to start the servers.

- Start both servers simultaneously
- Start the first server, and then start the second server after the first server has started

Do not consecutively start and shutdown both servers (*). The servers communicate with each other to determine whether the mirror data stored on each server is up to date. Consecutively starting and shutting down both servers prevents the servers from properly determining whether mirror data is up to date and mirror disk resources will fail to start the next time both servers are started.

(*) In other words, do not start and shut down the first server, and then start and shut down the second server.

Understanding registry synchronization resources

Dependencies of registry synchronization resources

By default, this function depends on the following group resource types.

Group resource type
Floating IP resource
Virtual IP resource
Virtual computer name resource
Disk resource
Mirror disk resource
Hybrid disk resource
Print spooler resource
CIFS resource
NAS resource
AWS elastic ip resource
AWS virtual ip resource
Azure probe port resource

Registry synchronization resources

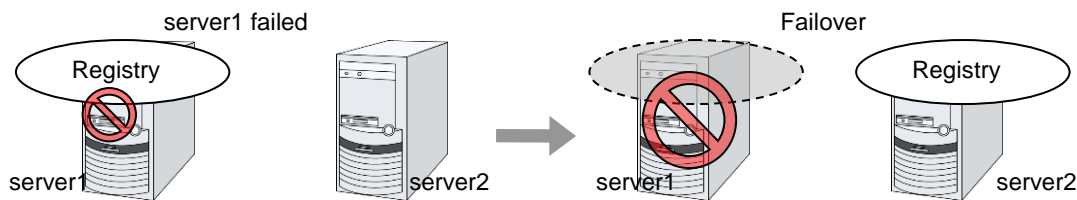

Registry keys to be synchronized at failover can be configured. When the content in a registry key set as synchronization target is updated while registry synchronization resource is active, the updated content is applied to the registry of the Failover Target Server.

The following describes how a registry synchronization resource synchronizes registry:

1. When there is a registry synchronization resource in a failover group, update of a registry key that has been configured is monitored when the registry synchronization resource is activated.
2. When the registry key update is detected, what is in the registry key is saved as a file in the local disk. Then the file is delivered to each Failover Target Server.
3. The servers that received the file keep it in their local disks. If a failover occurs and registry synchronization resource is activated in a server that received the file, the content of the file is restored in the corresponding registry key.

Notes on registry synchronization resources

- ◆ Do not open synchronization target registry keys in the standby server.
 - ◆ If a synchronization target registry key is opened when a failover occurs, restoration of the registry will fail. To start and stop applications that use the synchronization target registry key, use a script resource within a control of EXPRESSCLUSTER.
 - ◆ Minimize the number of synchronization target registry keys. Do not set more than needed. It is not recommended to set a registry key that is frequently updated as a synchronization target registry key.
 - ◆ Saving in a file and delivering the file to other servers is done every time a synchronization target registry key is updated. The number of synchronization target registry keys and frequency of updating them can affect the system performance. Do not change or update a synchronization target registry key.
 - ◆ For the synchronization target registry keys, the following can be set. The registry keys other than those listed below cannot be synchronized.
 - ◆ Any key under the HKEY_USERS
 - ◆ Any key under the HKEY_LOCAL_MACHINE
- Do not set the following keys.
- ◆ Keys under the HKEY_LOCAL_MACHINE/SOFTWARE/NEC/EXPRESSCLUSTER
 - ◆ HKEY_LOCAL_MACHINE/SOFTWARE/NEC
 - ◆ HKEY_LOCAL_MACHINE/SOFTWARE
 - ◆ HKEY_LOCAL_MACHINE
- Do not set the keys that are in parent-child relationship within the same resource.
- ◆ Up to 16 synchronization target registry keys can be set per resource.
 - ◆ The following restrictions apply to names of the synchronization target registry keys:
 - ◆ The characters that can be used for registry key are determined by the OS specifications.
 - ◆ Up to 259 bytes can be used. Do not set the key name of 260 or larger bytes.

Displaying and changing the details of registry synchronization resource

1. From the tree view displayed on the left pane of the Builder, click the icon of the group to which the registry synchronization resource whose detailed information and settings you want to display and/or change belongs.
2. The group resource list is displayed on the table view in the right pane of the window. Right-click the desired registry synchronization name, click **Properties** on the shortcut menu. In the properties dialog box, click the **Details** tab.
3. Display and/or change the detailed settings on the **Details** tab as described below.

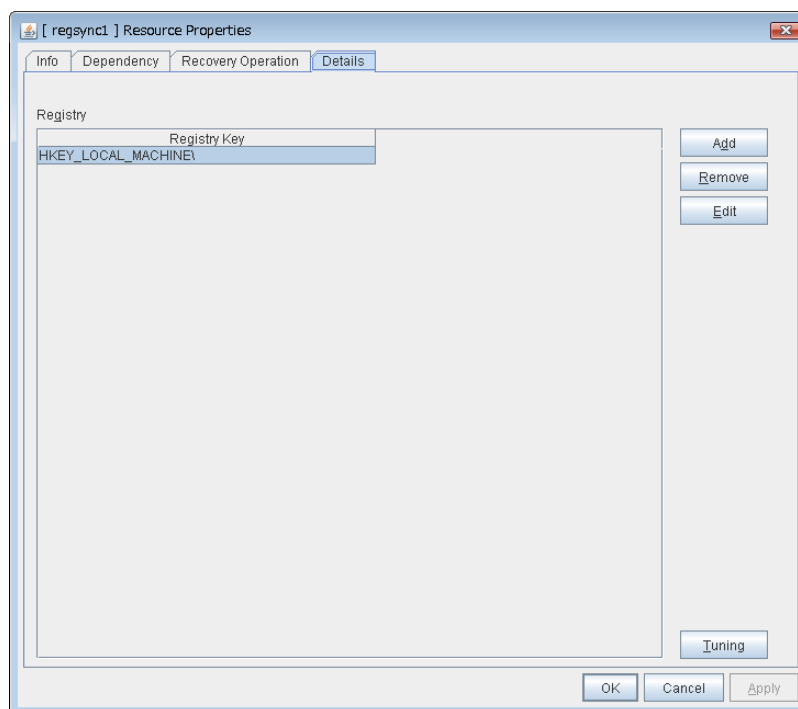

Add **SuspendResume** **GroupStopRestart**

Use this button to add a registry key to monitor. The **Enter registry key** dialog box is displayed.

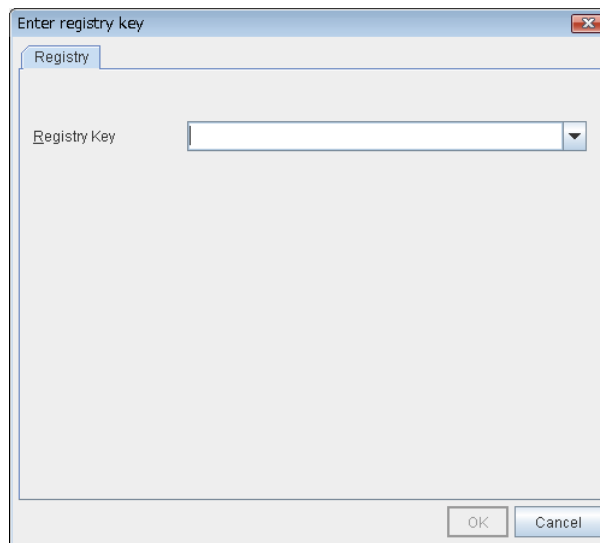

Registry Key

Enter a registry key to synchronize and click **OK**.

Remove **SuspendResume** **GroupStopRestart**

Click this button to delete a registry key from synchronization target listed in **Registry List**.

Edit **SuspendResume** **GroupStopRestart**

The **Enter registry key** dialog box is displayed. The selected registry keys are listed in **Registry List**. Edit a registry key and click **OK**.

Tuning registry synchronization resource

1. From the tree view displayed in the left pane of the window, click the icon of the group to which the registry synchronization resource whose detailed information and settings you want to display and/or change belongs.
2. The group resource list is displayed on the table view in the right pane of the window. Right-click the desired registry synchronization resource name, select **Properties** on the shortcut menu. In the properties dialog box, click the **Details** tab.
3. Clicking **Tuning** on the **Details** tab displays the **VxVM Volume Resource** dialog box. Display and/or change the detailed settings as described below.

Registry Synchronization Resource Tuning Properties

Parameter tab

The detailed setting for registry synchronization resource is displayed.

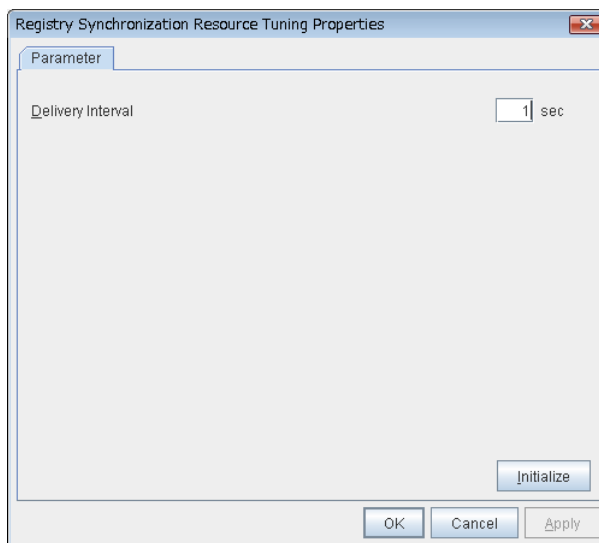

Delivery Interval (1 to 99) **SuspendResume**

Specify the interval to deliver the updated registry key information to other servers.

When short-time interval is set

- Updated information is immediately delivered to other servers.
- The system may get heavily loaded by frequently updating a registry key.

When long-time interval is set

- A delay in delivering updated information to other servers may occur. If a failover occurs before delivery of the updated information is not completed, it will not be delivered to the Failover Target Server.
- Increase in system load due to synchronization can be reduced when a registry key is frequently updated.

Initialize

Click **Initialize** to reset the values of all items to their default values.

Displaying the registry synchronization resource properties with the WebManager

1. Start the WebManager (*http:// Management IP address or the IP address of the cluster: port_number* (the default value is 29003)).
2. Click an object for registry synchronization resource  in the tree view. The following information is displayed in the list view.

Registry Synchronization Name: regsync1		Details
<div style="display: flex; justify-content: space-between;"> Common server1 server2 </div>		
Properties	Value	
Comment		
Registry Key	HKEY_LOCAL_MACHINE\SOFTWARE\	
Status	Online	
Started Server	server1	

Comment: Registry synchronization comment
Registry Key: Registry key to be synchronized
Status: Status of the registry synchronization resource
Started Server: The server which the resource has started

Clicking **Details** also displays the following information in the popup dialog box:

Properties	Value
Name	regsync1
Type	regsync
Failover Target Server	Stable Server
Failover Threshold	Number of Servers
Retry Count at Activation Failure	0
Final Action at Activation Failure	No operation (not activate next resource)
Execute Script before Final Action	Off
Retry Count at Deactivation Failure	0
Final Action at Deactivation Failure	No operation (not deactivate next resource)
Execute Script before Final Action	Off
Dependent Resources	fip1,vip1,vcom1,md1,cifs1
Retry Interval at Activation Failure	5
Retry Interval at Inactivation Failure	5

Name: Registry synchronization resource name
Type: Resource type
Failover Target Server: Determination method of Failover Target Server
Failover Threshold: The number of failovers to be made at detection of an error
Retry Count at Activation Failure: The number of times activation is retried when an activation error is detected
Final Action at Activation Failure: Final action at an activation error
Execute Script before Final Action: Whether or not script is executed upon activation failure
Retry Count at Deactivation Failure: The number of times deactivation is retried when a deactivation error is detected
Final Action at Deactivation Failure: Final action at an deactivation error
Execute Script before Final Action: Whether or not script is executed upon deactivation failure
Dependent Resources: Dependent resource
Retry Interval at Activation Failure: Retry interval when activation failure is detected
Retry Interval at Inactivation Failure: Retry interval when deactivation failure is detected

Understanding script resources

You can register scripts managed by EXPRESSCLUSTER and run when starting, stopping, failing over, or moving a group in EXPRESSCLUSTER. It is also possible to register your own scripts for script resources.

Note:

The same version of the application to be run from script resources must be installed on all servers in failover policy.

Dependencies of script resources

By default, this function depends on the following group resource types.

Group resource type
Floating IP resource
Virtual IP resource
Virtual computer name resource
Disk resource
Mirror disk resource
Hybrid disk resource
Print spooler resource
Registry synchronization resource
CIFS resource
NAS resource
AWS elastic ip resource
AWS virtual ip resource
Azure probe port resource

Scripts in script resources

Types of scripts

Start script and stop script are provided in script resources. EXPRESSCLUSTER runs a script for each script resource when the cluster needs to change its status. You have to write procedures in these scripts about how you want applications to be started, stopped, and restored in your cluster environment.

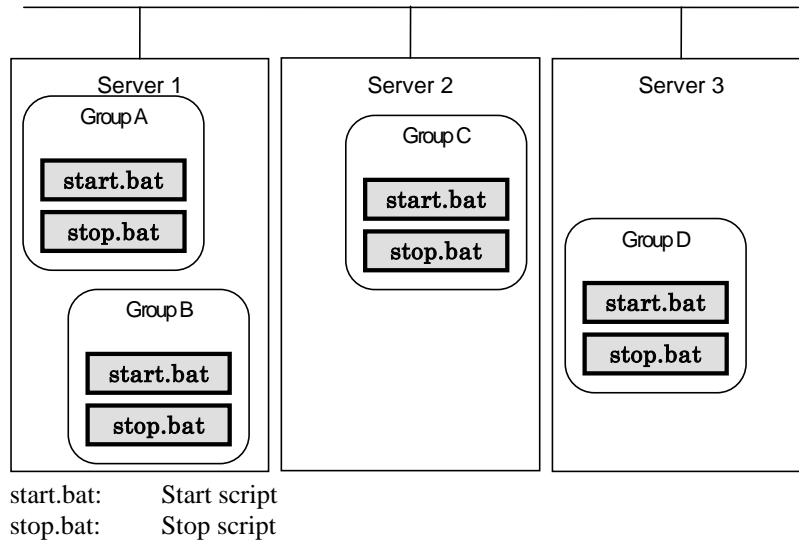

Environment variables in script of script resource

When EXPRESSCLUSTER runs a script, it records information such as the condition when the script is run (script starting factor) in environment variables.

You can use the environment variables on the table below as branching condition to write code for your system operation.

The environment variable of a stop script returns the content of the start script that was run immediately before as a value. Start script does not set environment variables of CLP_FACTOR.

The environment variable of CLP_LASTACTION is set only when the environment variable CLP_FACTOR is CLUSTERSHUTDOWN or SERVERSHUTDOWN.

Environment Variable	Value of environment variable	Meaning
CLP_EVENT ...script starting factor	START	The script was run: - by starting a cluster; - by starting a group; - on the destination server by moving a group; - on the same server by restarting a group due to the detection of a monitor resource error; or - on the same server by restarting a group resource due to the detection of a monitor resource/ARMLoad command error.
	FAILOVER	The script was run on the Failover Target Server: - by the server's failing; - due to the detection of a monitor resource/ARMLoad command error; or - because activation of group resources failed.
	RECOVER	- The server is recovered; - due to detection of a monitor resource/ARMLoad command error; or - because activation of group resources failed.
CLP_FACTOR ...group stopping factor	CLUSTERSHUTDOWN	The group was stopped by stopping the cluster.
	SERVERSHUTDOWN	The group was stopped by stopping the server.
	GROUPSTOP	The group was stopped by stopping the group.
	GROUPMOVE	The group was moved by moving the group.
	GROUPFAILOVER	The group failed over because an error was detected in monitor resource; or the group failed over because of activation failure in group resources.
	GROUPRESTART	The group was restarted because an error was detected in monitor resource.
	RESOURCESTART	The group resource was restarted because an error was detected in monitor resource.

Environment Variable	Value of environment variable	Meaning
CLP_LASTACTION ...process after cluster shutdown	REBOOT	In case of rebooting OS
	HALT	In case of halting OS
	NONE	No action was taken.
CLP_SERVER ...server where the script was run	HOME	The script was run on the primary server of the group.
	OTHER	The script was run on a server other than the primary server of the group.
CLP_DISK ...partition connection information on shared or mirror disks	SUCCESS	There was no partition with connection failure.
	FAILURE	There was one or more partition with connection failure.
CLP_PRIORITY ... the order in failover policy of the server where the script is run	1 to the number of servers in the cluster	Represents the priority of the server where the script is run. This number starts from 1 (The smaller the number, the higher the server's priority). If CLP_PRIORITY is 1, it means that the script is run on the primary server.
CLP_GROUPNAME ...Group name	Group name	Represents the name of the group to which the script belongs.
CLP_RESOURCENAME ...Resource name	Resource name	Represents the name of the resource to which the script belongs.
CLP_VERSION_FULL ...EXPRESSCLUSTER full version	EXPRESSCLUSTER full version	Represents the EXPRESSCLUSTER full version. (Example) 11.30
CLP_VERSION_MAJOR ...EXPRESSCLUSTER major version	EXPRESSCLUSTER major version	Represents the EXPRESSCLUSTER major version. (Example) 11
CLP_PATH ...EXPRESSCLUSTER install path	EXPRESSCLUSTER install path	Represents the path where EXPRESSCLUSTER is installed. (Example) C:\Program Files\EXPRESSCLUSTER
CLP_OSNAME ...Server OS name	Server OS name	Represents the OS name of the server where the script was executed. (Example) Windows Server 2008 R2 Datacenter SP1
CLP_OSVER ...Server OS version	Server OS version	Represents the OS version of the server where the script was executed. (Example) 6.1.1.0.128.3

Note:

On Windows Server 2012 R2 or later, CLP_OSNAME, CLP_OSVER is set the same information as on Windows Server 2012.

Execution timing of script resource scripts

This section describes the relationships between the execution timings of start and stop scripts and environment variables according to cluster status transition diagram.

- ◆ To simplify the explanations, a 2-server cluster configuration is used as an example. See the supplements for the relations between possible execution timings and environment variables in 3 or more server configurations.
- ◆ O and X in the diagrams represent the server status.

Server	Server status
O	Normal (properly working as a cluster)
X	Stopped (cluster is stopped)

(Example) OA: Group A is working on a normally running server.

- ◆ Each group is started on the top priority server among active servers.
- ◆ Three Group A, B and C are defined in the cluster, and they have their own failover policies as follows:

Group	First priority server	Second priority server
A	server1	server2
B	server2	server1
C	server1	server2

- ◆ The upper server is referred to as server1 and the lower one as server2.

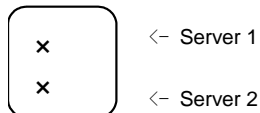

Cluster status transition diagram

This diagram illustrates a typical status transition of cluster.

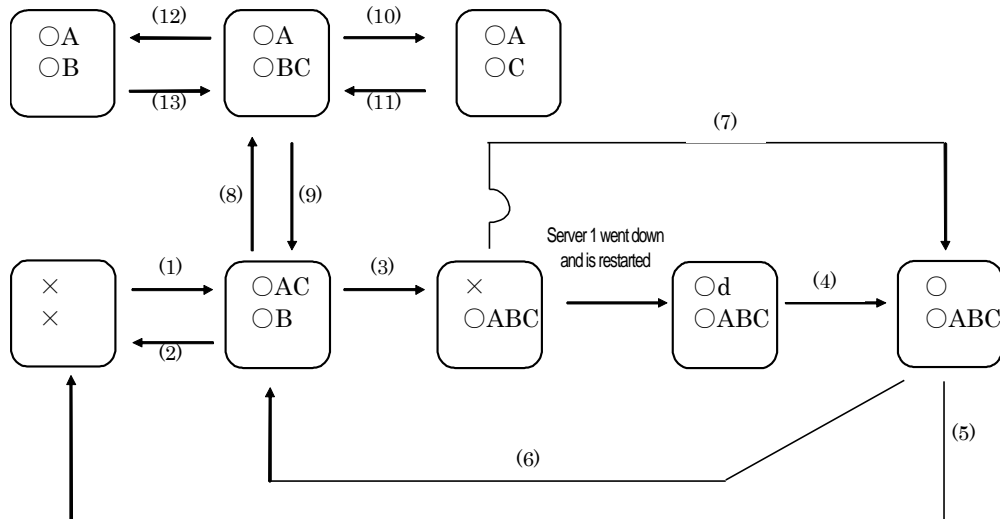

Numbers (1) to (13) in the diagram correspond to descriptions as follows.

(1) Normal startup

Normal startup here refers to that the start script has been run properly on the primary server.

Each group is started on the server with the highest priority among the active servers.

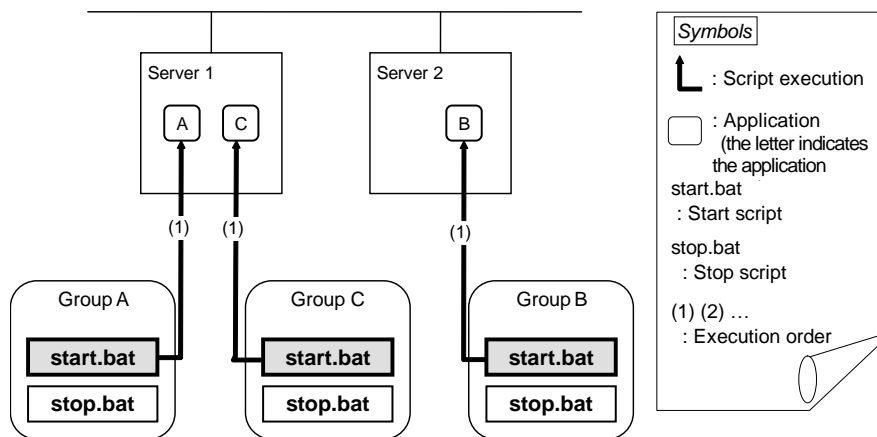

Environment variables for start.bat

Group	Environment variable	Value
A	(1) CLP_EVENT	START
	CLP_SERVER	HOME
B	(1) CLP_EVENT	START
	CLP_SERVER	HOME
C	(1) CLP_EVENT	START
	CLP_SERVER	HOME

(2) Normal shutdown

Normal shutdown here refers to a cluster shutdown immediately after the start script corresponding to a stop script was run by performing normal startup or by moving a group (online failback).

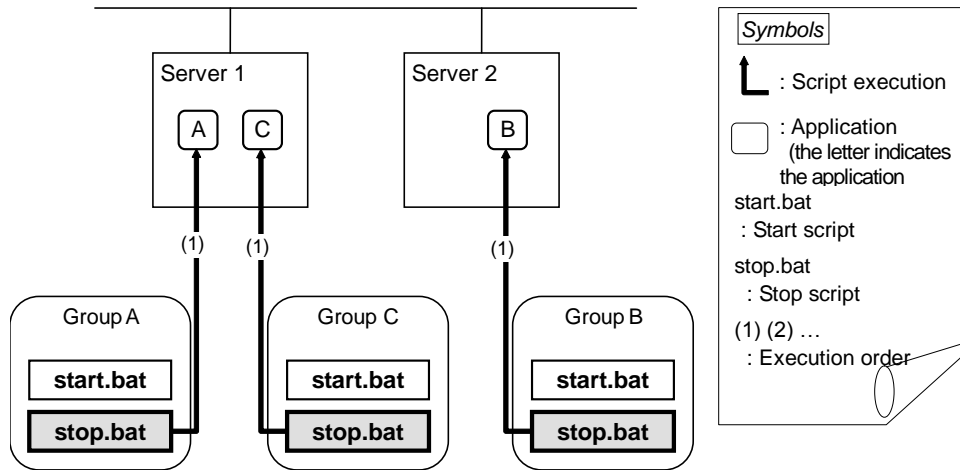

Environment variables for stop.bat

Group		Environment variable	Value
A	(1)	CLP_EVENT	START
		CLP_SERVER	HOME
B	(1)	CLP_EVENT	START
		CLP_SERVER	HOME
C	(1)	CLP_EVENT	START
		CLP_SERVER	HOME

(3) Failover at the failed server1

The start script of a group that has server1 as its primary server will be run on a lower priority server (server2) if an error occurs. You need to write CLP_EVENT(=FAILOVER) as a branching condition for triggering application startup and recovery processes (such as database rollback process) in the start script in advance.

For the process to be performed only on a server other than the primary server, specify CLP_SERVER(=OTHER) as a branching condition and describe the process in the script.

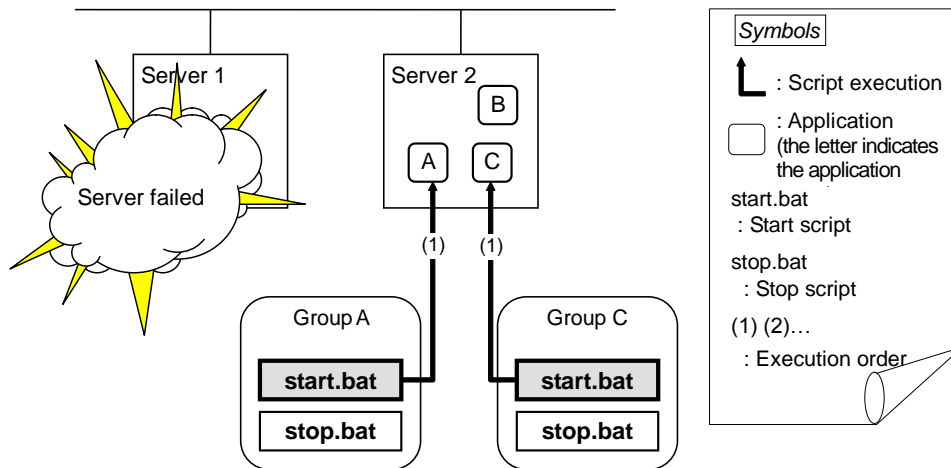

Environment variables for start.bat

Group		Environment variable	Value
A	(1)	CLP_EVENT	FAILOVER
		CLP_SERVER	OTHER
C	(1)	CLP_EVENT	FAILOVER
		CLP_SERVER	OTHER

(4) Recovering server1 to cluster

When server1 that has been rebooted (operating as non-cluster) returns to a cluster, the start script of the failover group that was running when a failover occurred is run in server1. This means recovery is executed in the server where the failover has occurred.

To execute a recovery (for example, recovering database information in a local disk), you need to write CLP_EVENT(=RECOVER) as a branching condition. Even if recovery is not required, you need to write the script not to start the operation.

For data mirroring operation, data is restored (reconfiguration of mirror set) at cluster recovery.

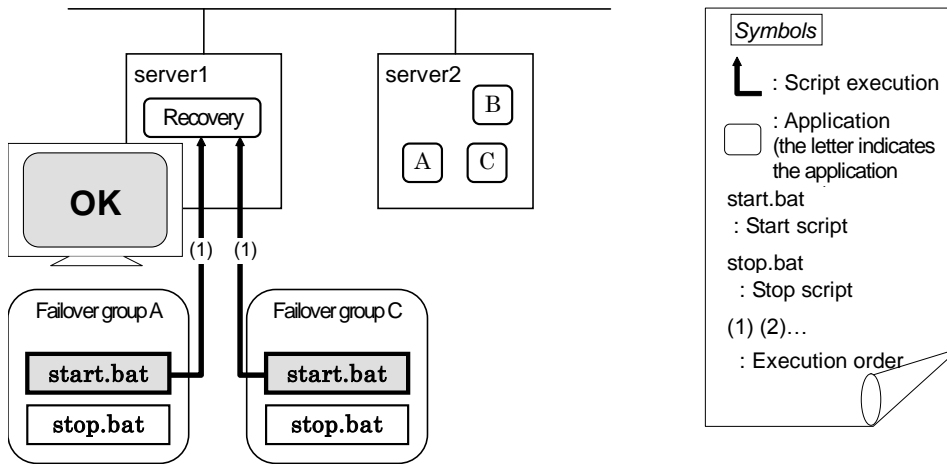

Environment variables for start.bat

Group		Environment variable	Value
A	(1)	CLP_EVENT	RECOVER
		CLP_SERVER	HOME
C	(1)	CLP_EVENT	RECOVER
		CLP_SERVER	HOME

(5) Cluster shutdown after failover of server1

The stop scripts of the Group A and C are run on server2 to which the groups failed over (the stop script of Group B is run by a normal shutdown).

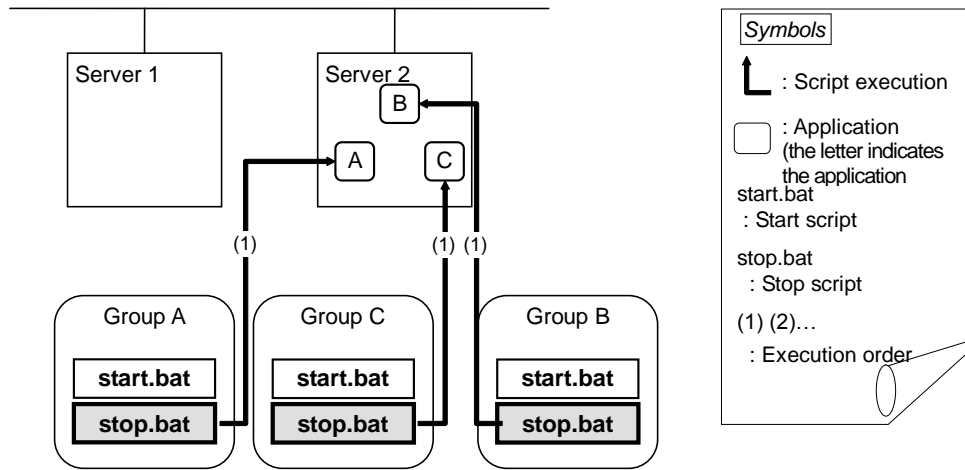

Environment variables for stop.bat

Group	Environment variable	Value
A	(1) CLP_EVENT	FAILOVER
	CLP_SERVER	OTHER
B	(1) CLP_EVENT	START
	CLP_SERVER	HOME
C	(1) CLP_EVENT	FAILOVER
	CLP_SERVER	OTHER

(6) Moving of Group A and C

After the stop scripts of Group A and C are run on server2 to which the groups failed over, their start scripts are run on server1.

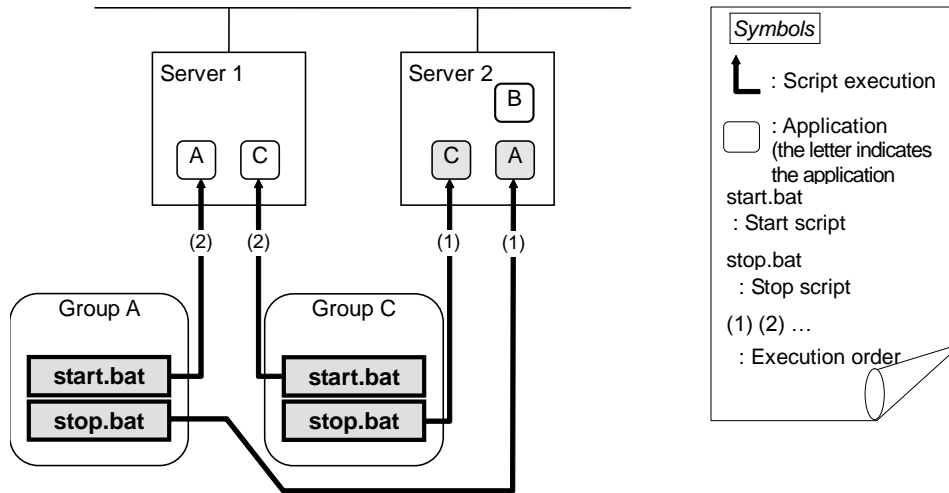

Environment variables for stop.bat

Group	Environment variable	Value
A (1)	CLP_EVENT	FAILOVER ²
	CLP_SERVER	OTHER
C (1)	CLP_EVENT	FAILOVER
	CLP_SERVER	OTHER

Environment variables for start.bat

Group	Environment variable	Value
A (2)	CLP_EVENT	START
	CLP_SERVER	HOME
C (2)	CLP_EVENT	START
	CLP_SERVER	HOME

² Environment variables in a stop script take those in the previous start script.

For moving in “(6) Moving of Group A and C” because it is not preceded by a cluster shutdown, the environment variable used here is FAILOVER. However, if a cluster shutdown is executed before moving in “(6) Moving of Group A and C”, the environment variable is START.

(7) server1 startup (Auto recovery mode)

Auto recovery of server1 is executed. The start script of the failover group operated when a failover occurred is run in server1. This means, recovery is executed in the server where the failover occurred. Note what is stated in “(4) Recovering server1 to cluster” on page 624. For data mirroring operation, data is restored (reconfiguration of mirror set) at cluster recovery.

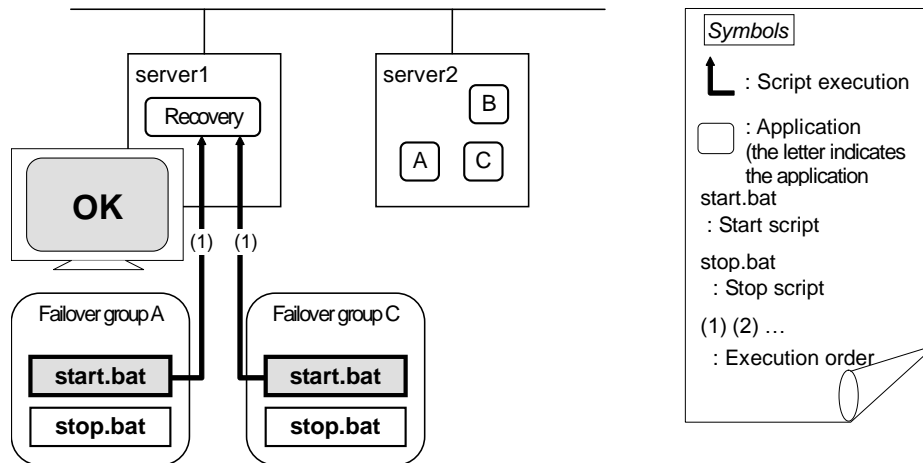

Environment variables for start.bat

Group		Environment variable	Value
A	(1)	CLP_EVENT	RECOVER
		CLP_SERVER	HOME
C	(1)	CLP_EVENT	RECOVER
		CLP_SERVER	HOME

(8) Error in Group C and failover

When an error occurs in Group C, its stop script is run on server1 and start script is run on server2.

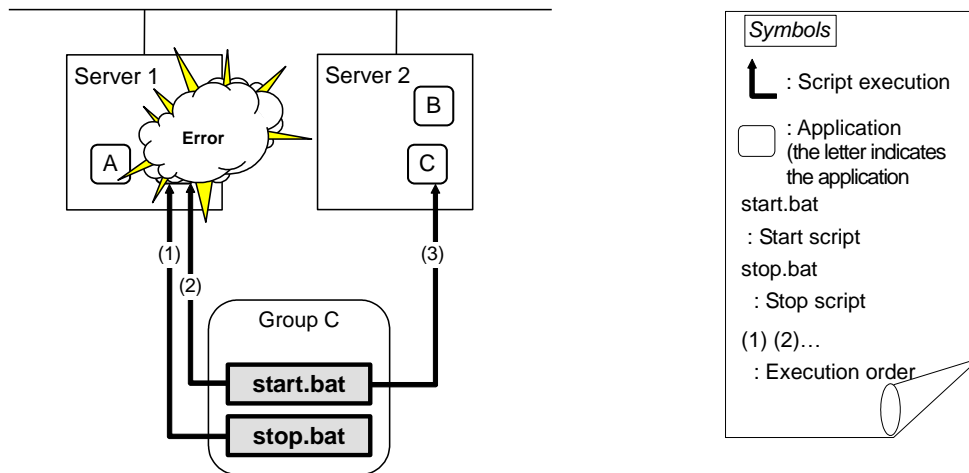

The environment variables of Server1 for stop.bat

Group	Environment variable	Value
C	(1) CLP_EVENT	START
	CLP_SERVER	HOME

Environment variables of Server 1 for start.bat

Group	Environment variable	Value
C	(2) CLP_EVENT	RECOVER

The environment variables of Server2 for start.bat

Group	Environment variable	Value
C	(3) CLP_EVENT	FAILOVER
	CLP_SERVER	OTHER

(9) Moving of Group C

Move the Group C that failed over to server2 in (8) from server2 to server1. Run the stop script on server2, and then run the start script on server1.

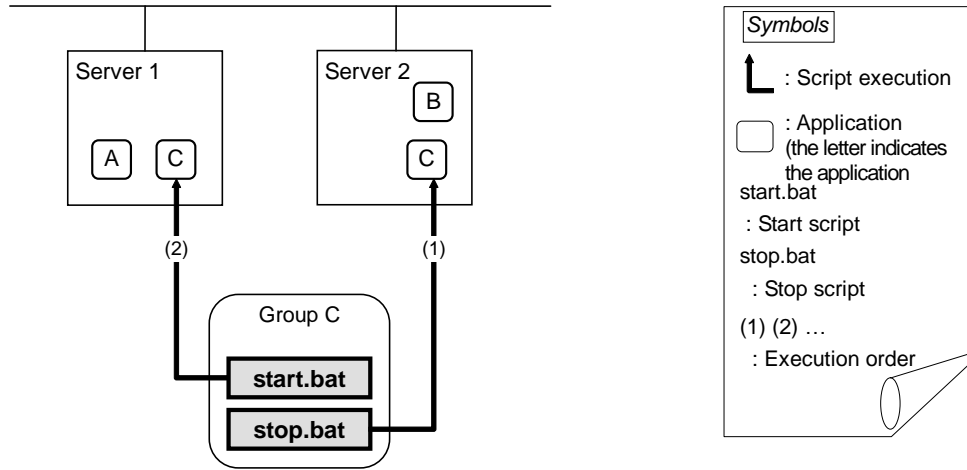

The environment variables for stop.bat (because of failover from (8))

Group	Environment variable	Value
C	(1) CLP_EVENT	FAILOVER
	CLP_SERVER	OTHER

The environment variables for start.bat

Group	Environment variable	Value
C	(2) CLP_EVENT	START
	CLP_SERVER	HOME

(10) Stopping Group B

The stop script of Group B is run on server2.

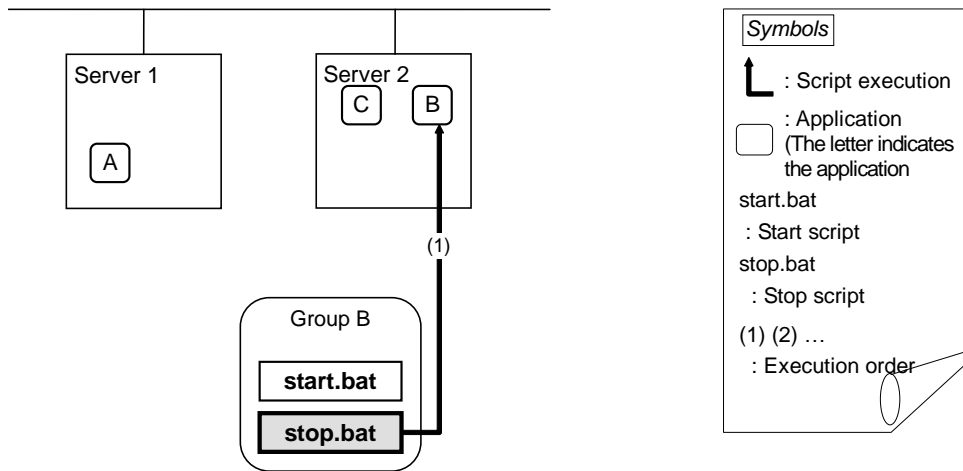

The environment variables for stop.bat

Group		Environment variable	Value
B	(1)	CLP_EVENT	START
		CLP_SERVER	HOME

(11) Starting Group B

The start script of Group B is run on server2.

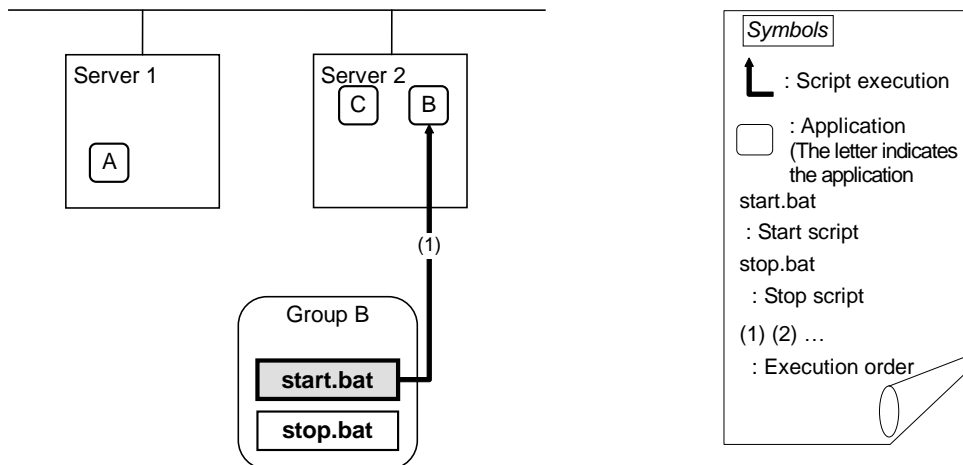

The environment variables for start.bat

Group		Environment variable	Value
B	(1)	CLP_EVENT	START
		CLP_SERVER	HOME

(12) Stopping Group C

The stop script of Group C is run on server2.

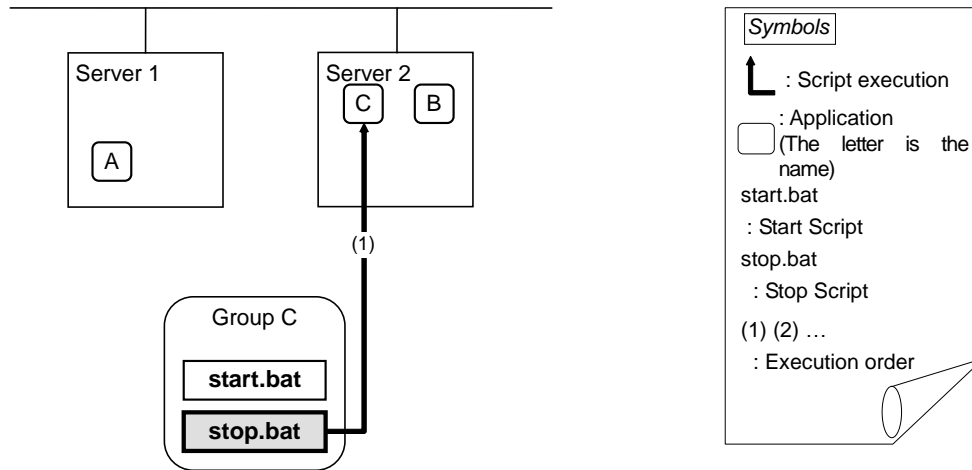

The environment variables for stop.bat

Group		Environment variable	Value
C	(1)	CLP_EVENT	FAILOVER
		CLP_SERVER	OTHER

(13) Starting Group C

The start script of Group C is run on server2.

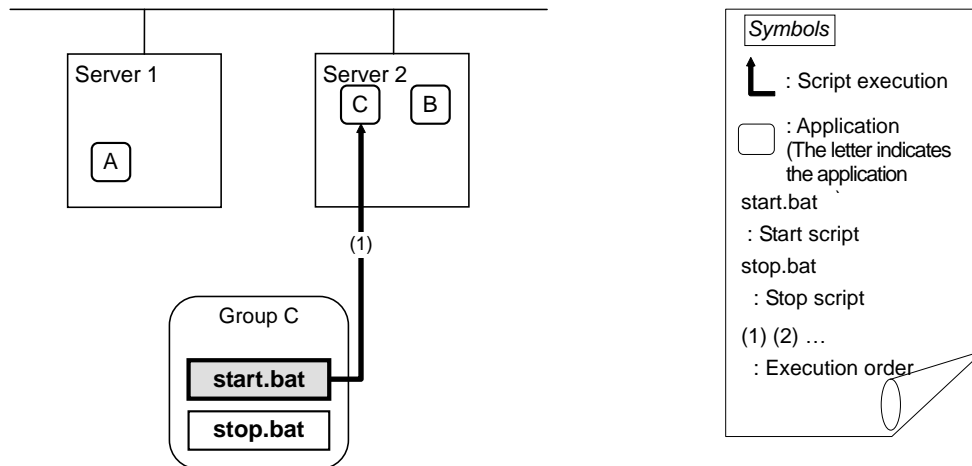

The environment variables for start.bat

Group		Environment variable	Value
C	(1)	CLP_EVENT	START
		CLP_SERVER	OTHER

Additional information 1

For a group that has three or more servers specified in the failover policy to behave differently on servers other than the primary server, use CLP_PRIORITY instead of CLP_SERVER (HOME/OTHER).

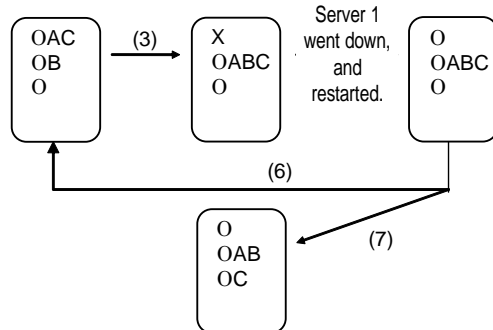

Example 1: “(3) Failover at the failed server1” in the cluster status transition diagram

A group has server1 as its primary server. If an error occurs on server1, the group’s start script is run on server2 that has next highest priority failover policy. You need to write CLP_EVENT(=FAILOVER) as the branching condition for triggering applications’ startup and recovery processes (such as database rollback) in the start script in advance.

For a process to be performed only on the server that has the second highest priority failover policy, you need to write CLP_PRIORITY(=2) as the branching condition.

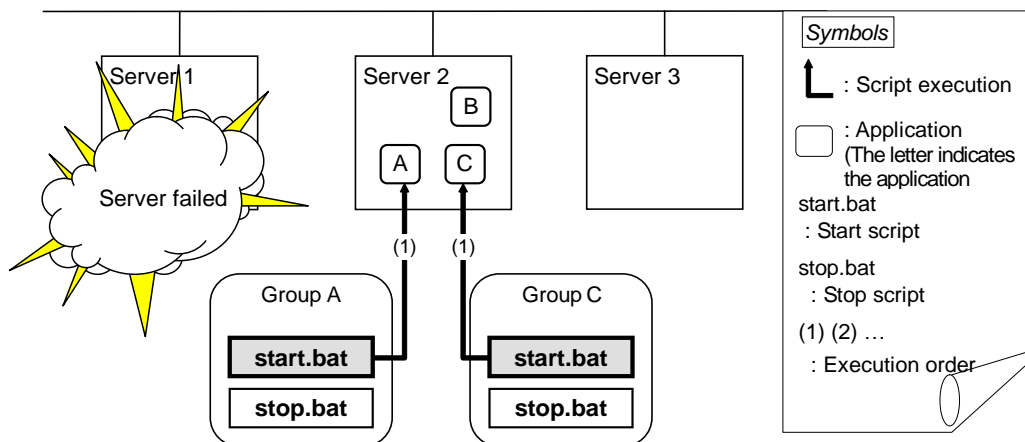

Environment variables for start.bat

Group	Environment variable	Value
A	(1) CLP_EVENT	FAILOVER
	CLP_SERVER	OTHER
	CLP_PRIORITY	2
C	(1) CLP_EVENT	FAILOVER
	CLP_SERVER	OTHER
	CLP_PRIORITY	2

Example 2: “(6) Moving of Group A and C” in the cluster status transition diagram

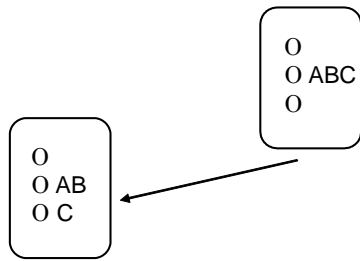

After the stop scrip of Group C is run on server2 from which the group failed over, the start scrip is run on server3.

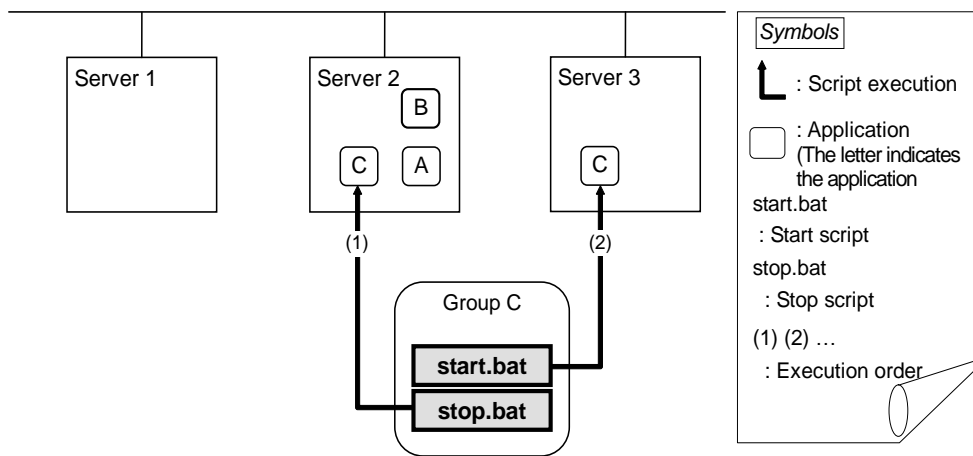

Environment variables for stop.bat

Group	Environment variable	Value
C	(1) CLP_EVENT	FAILOVER
	CLP_SERVER	OTHER
	CLP_PRIORITY	2

Environment variables for start.bat

Group	Environment variable	Value
C	(1) CLP_EVENT	START
	CLP_SERVER	OTHER
	CLP_PRIORITY	3

Additional information 2

When a monitor resource or ARMLOAD command starts or restarts a script:

The environment variables to run a start script when a monitor resource or ARMLOAD command detected an error in application are as follows:

Example 1: a monitor resource or ARMLOAD command detected an error and restarts Group A on the server1.

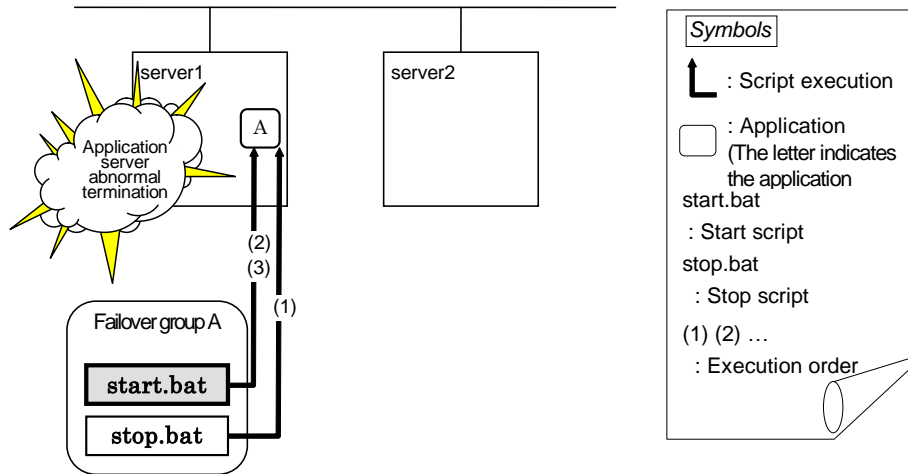

Environment variable for stop.bat

Group	Environment variable	Value
A (1)	CLP_EVENT	The same value as when the start script is run

Environment variable for start.bat

Group	Environment variable	Value	
A	(2)	CLP_EVENT	RECOVER
	(3)	CLP_EVENT	START

* start.bat is executed twice.

Example2: a monitor resource or ARMLoad command detected an error and restarts Group A on server2 through failover to server2.

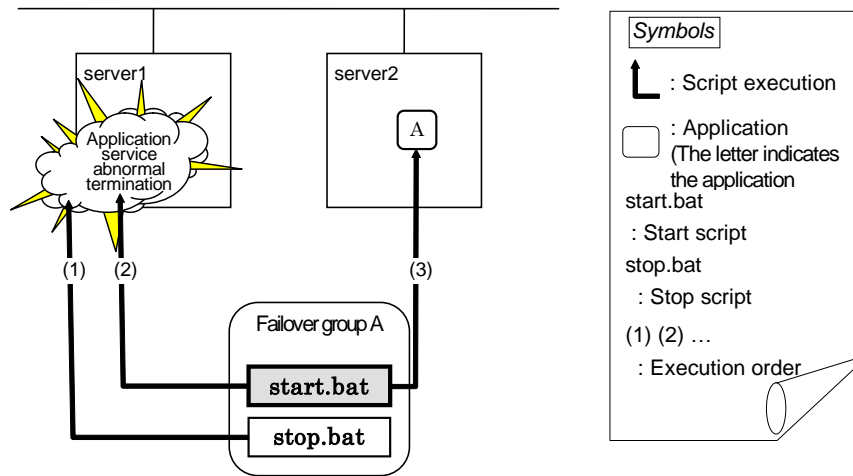

Environment variable for stop.bat

Group		Environment variable	Value
A	(1)	CLP_EVENT	The same value as when the start script is run

Environment variable for start.bat

Group		Environment variable	Value
A	(2)	CLP_EVENT	RECOVER
	(3)	CLP_EVENT	FAILOVER

Writing scripts

This section describes how you actually write script codes in association with timing to run scripts as mentioned in the previous topic.

Numbers in brackets “(number)” in the following example script code represent the actions described in “Execution timing of script resource scripts” on page 620.

A. Group A start script: a sample of **start.bat**

```

rem *****
rem *          START.BAT          *
rem *****

IF "%CLP_EVENT%" == "START" GOTO NORMAL
IF "%CLP_EVENT%" == "FAILOVER" GOTO FAILOVER
IF "%CLP_EVENT%" == "RECOVER" GOTO RECOVER

GOTO no_arm

:NORMAL
IF "%CLP_DISK%" == "FAILURE" GOTO ERROR_DISK

IF "%CLP_SERVER%" == "OTHER" GOTO ON_OTHER1

GOTO EXIT

:ON_OTHER1

GOTO EXIT

:FAILOVER
IF "%CLP_DISK%" == "FAILURE" GOTO ERROR_DISK
    
```

Refer to the environment variable of script executing factor and divide the processes.

ExpressCluster is not operating.

Overview of processing:
 Application's normal startup processing
When to start this process:
 (1) Normal startup
 (6) Moving failover group (online fallback)

Refer to the environment variable of executing server and divide the processes.

Overview of processing:
 A process to be executed only when the application is normally started on the primary server.
When to start this process:
 (1) Normal startup
 (6) Moving failover group (online fallback)

Overview of processing:
 A process to be executed only when the application is normally started on the server other than the primary server.
When to start this process:

Refer to the DISK connection information environment variable and handle the error.

Overview of processing:
 Application's normal startup processing
When to start this process:
 (3) Failing over due to server1 down

```

IF "%CLP_SERVER%" == "OTHER" GOTO ON_OTHER2

```

Refer to the environment variable of script executing factor and divide the processes.

Overview of processing:
 A process to be executed only when the application is started on the primary server after failover
When to start this process:

```

GOTO EXIT

:ON_OTHER2

```

Overview of processing:
 A process to be executed only when the application is terminated on the non-primary server after failover.
When to start this process:
 (3) Failing over due to server1 down

```

GOTO EXIT

:RECOVER

```

Overview of processing:
 Recovery processing after cluster recovery
When to start this process:
 (4) Cluster recovery

```

GOTO EXIT

:ERROR_DISK

```

Disk-related error handling

```

:no_arm

:EXIT
exit

```

B. Group A stop script: a sample of stop.bat

```

rem *****
rem *          STOP.BAT          *
rem *****

IF "%CLP_EVENT%" == "START" GOTO NORMAL
IF "%CLP_EVENT%" == "FAILOVER" GOTO FAILOVER

GOTO NO_ARM

:NORMAL
IF "%CLP_DISK%" == "FAILURE" GOTO ERROR_DISK

IF "%CLP_SERVER%" == "OTHER" GOTO ON_OTHER1

GOTO EXIT

:ON_OTHER1

GOTO EXIT

:FAILOVER

IF "%CLP_DISK%" == "FAILURE" GOTO ERROR_DISK
    
```

Refer to the environment variable of script executing factor and divide the processes.

ExpressCluster is not operating.

Refer to the DISK connection information environment variable and handle the error.

Overview of processing:
Application's normal startup process
When to start this process:
(2) Normal shutdown

Refer to the environment variable of executing server and divide the processes.

Overview of processing:
A process to be executed only when the application is normally processed on the primary server.
When to start this process:
(2) Normal shutdown

Overview of processing:
A process to be executed only when the application is normally terminated on the server other than the primary server.
When to start this process:

Refer to the DISK connection information environment variable and handle the error.

Overview of processing:
Normal termination process after failover.
When to start this process:
(5) Cluster shutdown after failover of Server 1
(6) Moving of failover group A and C

IF "%CLP_SERVER%" == "OTHER" GOTO ON_OTEHR2

Refer to the environment variable of executing server and divide the processes.

Overview of processing:
 A process to be executed only when the application is terminated on the primary server after failover
When to start this process:

GOTO EXIT

:ON_OTHER2

Overview of processing:
 A process to be executed only when the application is terminated on the non-primary server after failover.
When to start this process:
 (5) Cluster shutdown after failover of Server 1
 (6) Moving of Group A and C

GOTO EXIT

:ERROR_DISK

Disk-related error handling

:NO_ARM

:EXIT
 exit

Tips for creating scripts

- ◆ The `clplogcmd` command can send alert messages to WebManager. Please use the command to notify the result of the script.

Notes on script resource

There are no specific notes with the resource.

Displaying and changing the settings of the script resource details

You can display and change the settings of the detail information of the script resources by using **Resource Properties** of the Builder.

Displaying and changing the script resource details

1. In the tree view shown on the left pane of the Builder, click the icon of the group to which the script resource whose detailed information you want to display or change belongs.
2. The list of group resources is displayed in the table view on the right pane of the screen. Right-click the name of the script resource that you want to display or change. Click **Properties**, and then click **Details** tab.
3. Display and/or change the settings by following the description below.

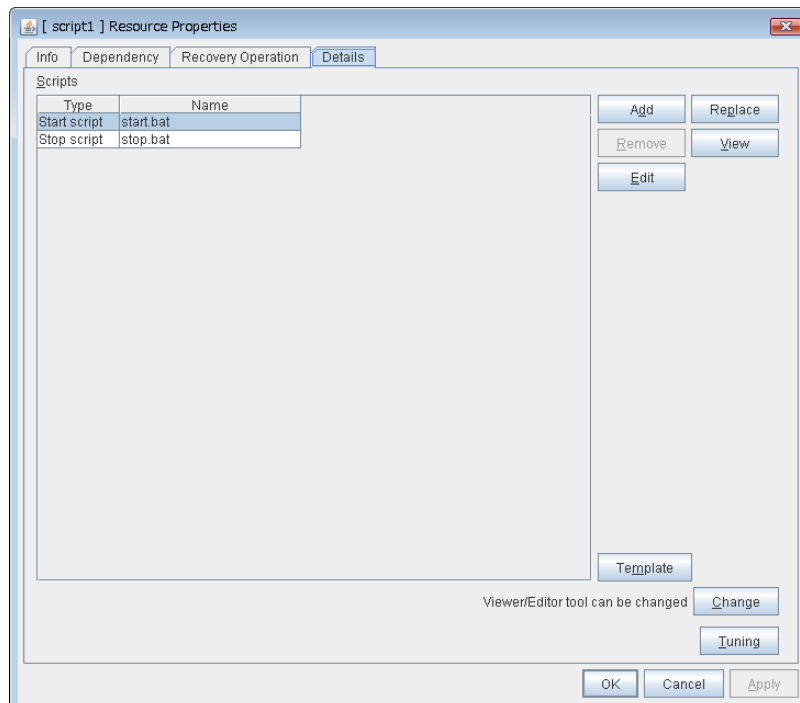

Change

Open a dialog box for changing script editor. You can change the script editor for viewing and editing scripts to any editor.

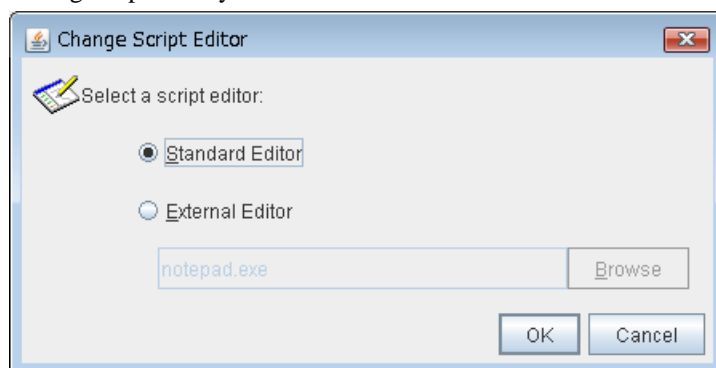

Standard Editor

Select this option to use the standard editor for editing scripts.

- ◆ Windows: Notepad (notepad.exe which is detected by the user's search path)

External Editor

Select this option to specify a script editor. Click **Browse** and specify the editor to be used.

Tuning

Open the **Script Resource Tuning Properties** dialog box. You can make advanced settings for the script resource.

Displaying and/or changing the script resource script created by the Builder

1. From the tree view in the left pane of the Builder, click the icon of the group to which script resource whose detail information you want to display and change belongs.
2. Group resource list is displayed on the table view in the right pane of the window. Right-click the script resource name. Then click **Properties** and select the **Details** tab.
3. Display and/or change the settings by following the description below.

The default script file names, start.bat and stop.bat, are listed on **Scripts**.

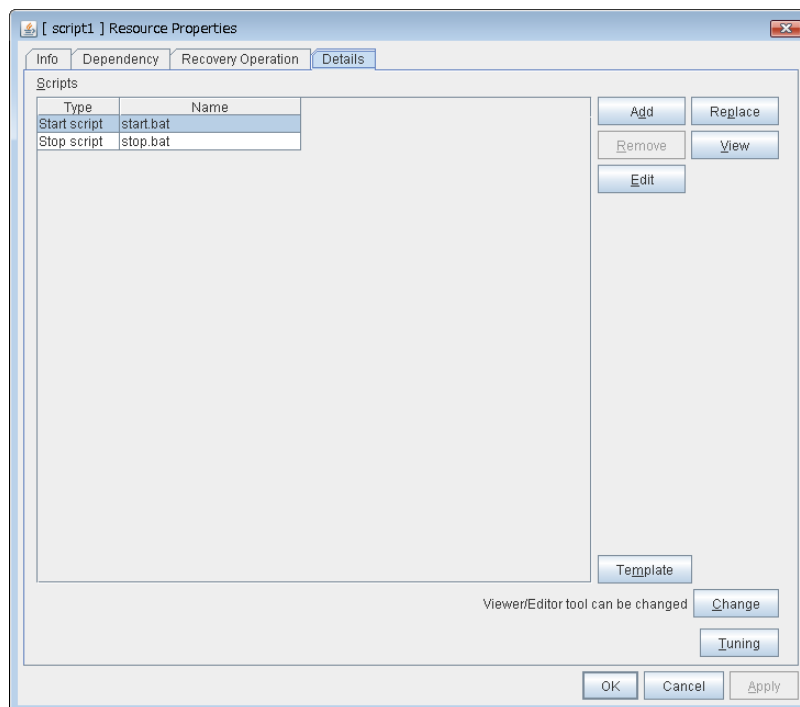

Add

Use this button to add a script other than start.bat script and stop.bat script.

Note: Do not use 2-byte characters for the name of a script to be added.

Remove

Use this button to delete a script. The start.bat script and stop.bat script cannot be deleted.

View

Use this button to display the selected script file on the script editor. Changes made and saved by the editor are not applied.

If the selected script file is being viewed or edited, you cannot see it.

Edit

Use this button to edit the selected script file on the script editor. To apply changes, overwrite the file. If the selected script file is being viewed or edited, you cannot edit it. You cannot rename the script file

Replace

Opens the **Open** dialog box, where you can select a file.

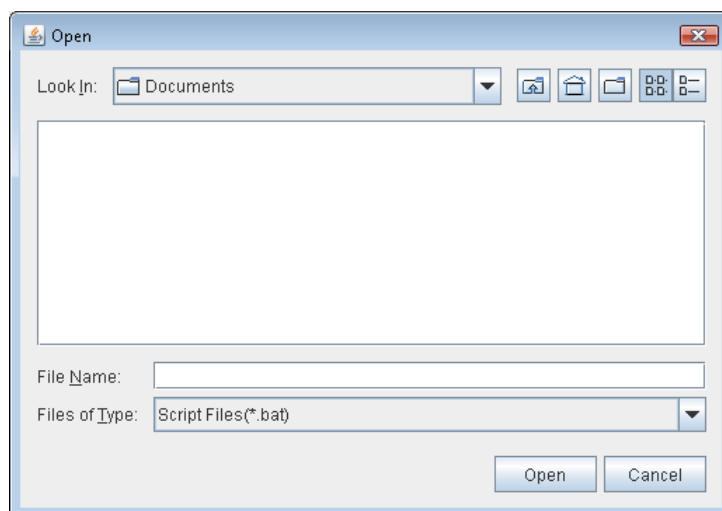

Note:

The file will not be deleted even if you delete a script file from the Builder. If the cluster configuration data is reloaded by restarting the Builder after deleting the script file, the deleted script file will be displayed in the **Scripts**.

The content of the script file selected in the **Resource Property** is replaced with the one selected in the **Open** dialog box. If the selected script file is being viewed or edited, replacement cannot be achieved. Select a script file, not a binary file such as an application program.

Using the simple selection function of a script template

Selecting an application from the script resource enables you to automatically replace the necessary script template. You can simply create a script by editing the template script.

Note:

To use this function, you must install the script template in advance.

1. From the tree view displayed in the left pane of the Builder, click the icon of the group to which the script resource whose script template to be replaced belongs.
2. A group resource list is displayed in the table view to the right of the window. Right-click the target script resource name and then click the **Details** tab of **Properties**.

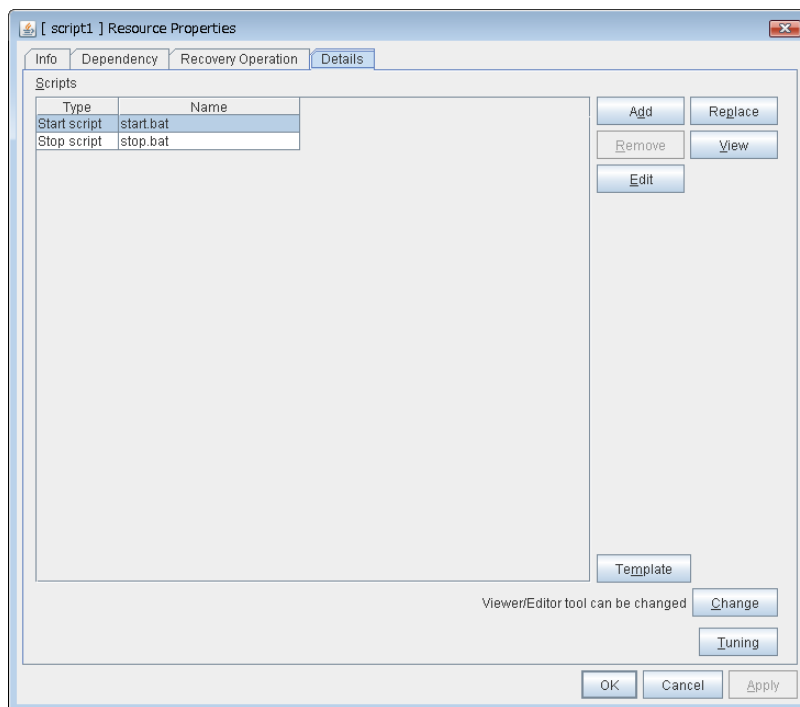

3. Click **Template**.
4. The **Script Template** dialog box is displayed.

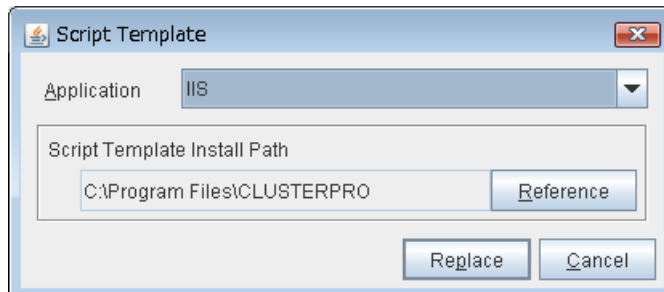

Application

Clicking **Application** displays the replaceable script template applications in a list box.

Note:

If the script template is not installed, nothing is displayed in the application list.

Reference

Clicking **Reference** displays the folder path where the script template is installed.

Note:

If the script template is not installed in the default folder path, a warning message appears. If the script template is installed, specify the correct install path.

Replace

Clicking **Replace** displays the **Script Replacement Confirmation** dialog box.

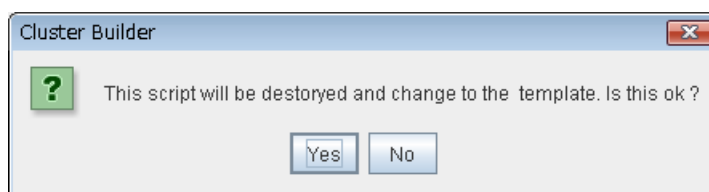

Clicking **OK** replaces the script.

Note:

You must edit the replaced script to suit your environment. For how to edit the script, see “Displaying and changing the script resource script created by the Builder.”

Tuning script resource

1. From the tree view displayed on the left pane of the Builder, click the icon of the group to which the script resource whose detail information you want to display and change belongs.
2. Group resource list is displayed on the table view in the right pane of the window. Right-click the script resource name. Then click **Properties** and select the **Details** tab.
3. On the **Details** tab, click **Tuning** to display **Script Resource Tuning Properties** dialog box.
4. Display and/or change the settings by following the description below.

Parameter tab

Common to all start scripts and stop scripts

Synchronous

Select this button to wait for a script to end when it is run.

Asynchronous

This cannot be selected.

Normal Return Value (Within 1023 bytes)

Configure what error code from the script is normal.

- ◆ When there is no value

The return value is ignored. This is the same operation as the X 2.1 and earlier.

- ◆ When there is a value

Observe the following input rules.

- Values can be separated by commas (for example, 0, 2, 3).
- Values can be specified using a hyphen (for example, 0-3).

Note:

When specifying a value to **Normal Return Value**, set the same value to start script and stop script.

An error cannot be detected when 1 is specified as **Normal Return Value** because 1 is returned when an error occurs with cmd.exe which executes the script.

Timeout 1 to 9999

When you want to wait for a script to end (when selecting **Synchronous**), specify how many seconds you want to wait before a timeout. This box is enabled when **Synchronous** is selected. If the script does not complete within the specified time, it is determined as an error.

Target VCOM Resource Name

Configure this to use a virtual computer name as a computer name used for script resources. Virtual computer names and resource names that exist in a failover group to which script resources belong are listed.

When you specify this parameter, add the following environment variables and then start the script:

```
COMPUTERNAME=<virtual computer name>
_CLUSTER_NETWORK_FQDN_=<virtual computer name>
_CLUSTER_NETWORK_HOSTNAME_=<virtual computer name>
_CLUSTER_NETWORK_NAME_=<virtual computer name>
```

Note: When **Target VCOM Resource Name** is specified, the EXPRESSCLUSTER commands cannot be used in a script.

Allow to Interact with Desktop

Specify whether to allow the script to be run to communicate with desktop. If this is selected, progress status of the script can be checked on the screen. (Windows Server 2003 only). It is effective if used when debugging the script.

Initialize

Click **Initialize** to reset the values of all items to their default values.

Displaying the script resource properties with the WebManager

1. Start the WebManager (*http://Management IP address or the IP address of the cluster server: port_number* (the default value is 29003)).
2. Click an object for script resource  in the tree view. The following information is displayed in the list view.

EXEC Name: script1		Details
<div style="display: flex; border-bottom: 1px solid black;"> Common server1 server2 </div>		
Properties	Value	
Comment		
Start Path	start.bat	
[Start]Normal Return Value		
Stop Path	stop.bat	
[Stop]Normal Return Value		
Status	Online	
Started Server	server1	

Comment: Script resource comment
Start Path: Path of the start script for script resource
[Start] Normal Return Value: The return value from the start script when it normally ended
Stop Path: Path of the stop script for script resource
[Stop] Normal Return Value: The return value from the stop script when it normally ended
Status: Status of script resource
Started Server: The server which the resource has started

If you click **Details**, the following information is displayed in the pop-up dialog.

Properties	Value
Name	script1
Type	script
Failover Target Server	Stable Server
Failover Threshold	Number of Servers
Retry Count at Activation Failure	0
Final Action at Activation Failure	No operation (not activate next resource)
Execute Script before Final Action	Off
Retry Count at Deactivation Failure	0
Final Action at Deactivation Failure	No operation (not deactivate next resource)
Execute Script before Final Action	Off
Dependent Resources	fip1,vip1,vcom1,md1,cifs1,regsync1
Retry Interval at Activation Failure	5
Retry Interval at Inactivation Failure	5
Target VCOM Name	
[Start]Type	Synchronous
[Start]Timeout (seconds)	1800
[Start]Allow To Interact With Desktop	Off
[Stop]Type	Synchronous
[Stop]Timeout (seconds)	1800
[Stop]Allow To Interact With Desktop	Off

Name: Script resource name
Type: Resource type
Failover Target Server: Determination method of Failover Target Server
Failover Threshold: The number of failovers to be made at detection of an error
Retry Count at Activation Failure: The number of times activation is retried when an activation error is detected
Final Action at Activation Failure: Final action at an activation error
Execute Script before Final Action: Whether or not script is executed upon activation failure

Retry Count at Deactivation Failure:	The number of times deactivation is retried when a deactivation error is detected
Final Action at Deactivation Failure:	Final action at a deactivation error
Execute Script before Final Action:	Whether or not script is executed upon deactivation failure
Dependent Resources:	Dependent resources
Retry Interval at Activation Failure:	Activation retry interval
Retry Interval at Inactivation Failure:	Deactivation retry interval
Target VCOM Name:	VCOM name that the script uses
[Start]Type:	Type of start application
[Start]Timeout (seconds):	Timeout for start application (seconds)
[Start]Allow to Interact with Desktop:	Allow start application to communicate with desktop
[Stop]Type:	Type of stop application
[Stop]Timeout (seconds):	Timeout for stop application (seconds)
[Stop]Allow to Interact with Desktop:	Allow stop application to communicate with desktop

Understanding disk resources

Dependencies of disk resources

By default, this function does not depend on any group resource type.

Disk resources

A disk resource refers to a switching partition on a shared disk accessed by more than one server that constitutes a cluster.

◆ Switching partitions

A switching partition refers to a partition on a shared disk connected to more than one server in a cluster.

Switching is done on a failover group basis according to the failover policy. By storing data required for applications on a switching partition, the data can be automatically inherited when failover takes place or a failover group is moved.

A switching partition should be accessible with the same drive letter in the same area on all servers.

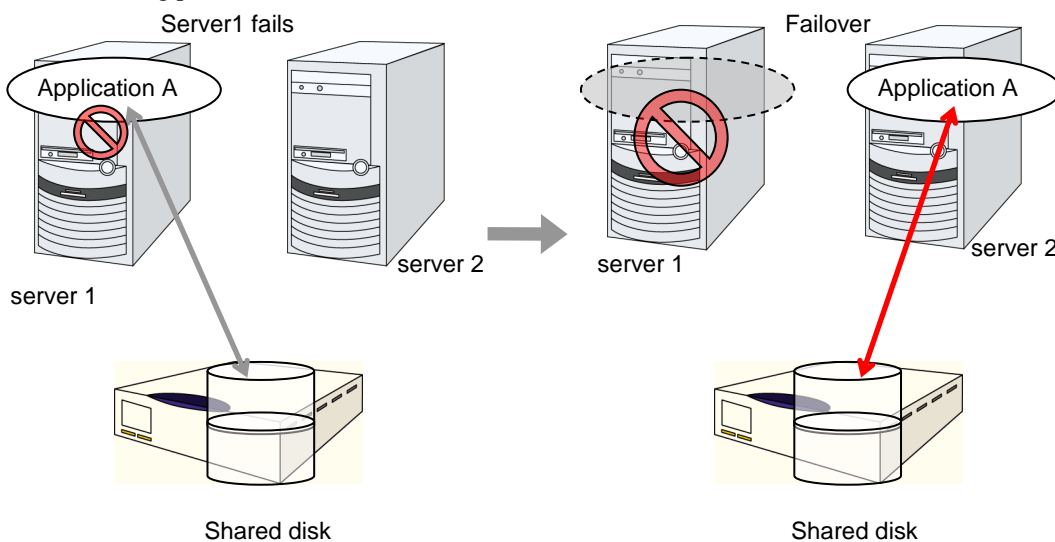

◆ Size of switching partitions

There is no restriction on partition size. Allocate any size for partition.

◆ File system

Format partitions with NTFS. FAT and FAT32 are not supported.

◆ Access control

EXPRESSCLUSTER controls access to file system.

- ◆ **Configuring Host Bus Adapters (HBAs)**

When more than one server is connected to a shared disk, simultaneous access from servers to the file system can corrupt the data. It is necessary to control accesses to a partition on a shared disk.

In EXPRESSCLUSTER, accesses to a shared disk are controlled by HBA (Host Bus Adapter) settings. Configure HBAs that connect a shared disk to control accesses.

For details, see “Server properties HBA tab” in Chapter 2, “Functions of the Builder” in this guide.
- ◆ **Configuring DISK network partition solution resource**

When a disk resource is used, it is recommended to use DISK network partition solution resource.

For the DISK network partition resolution resources, see “Understanding network partition resolution by DISK method” on page 1071.

Notes on disk resources

- ◆ Make settings so that the same partition is accessible with the same drive letter on all servers. Even if the drive letter automatically assigned by the OS is the same as the one that you want to assign, be sure to manually assign the drive letter explicitly; for example, by deleting the OS assigned drive letter and then assigning the desired drive letter.
- ◆ If a drive letter different from the one used on partition is set, the drive letter will be changed when the disk resource is started up. If the drive letter is used on other partitions, starting up the disk resource will fail.
- ◆ Dynamic disk is not supported. If a partition on dynamic disk is used for disk resource, starting up the disk resource will fail.
- ◆ Configure HBAs for a partition used for disk resource. If a partition without HBA configuration is used for disk resource, starting up resource will fail.

When HBA configuration is changed, OS reboot is required to apply the changes. If OS is not rebooted after changing HBA configuration, starting up disk resource will fail.

For details on HBA configuration, see “Server properties HBA tab” in Chapter 2, “Functions of the Builder” in this guide.
- ◆ If you try to change or delete a drive character after configuring the HBA when OS is Windows Server 2008 R2 or later, the operation may fail. If the operation fails, configure the HBA according to the troubleshooting procedure.

<Target OS>

- Each edition of Windows Server 2008 R2 and later

<Troubleshooting>

1. Run the following command at the command prompt to remove the drive character:

```
#mountvol drive_character (of_change_target):/P
```
2. Check that the drive character is removed from the change target drive by using (**Control Panel > Administrative Tools > Computer Management > Disk Management**).
3. Add the drive character from **Disk Management**.

Displaying and changing the details of disk resources

1. From the tree view displayed on the left pane of the Builder, click the icon of the group to which the disk resource whose detailed information you want to display and/or change belongs.
2. The group resource list is displayed in the table view in the right pane of the window. Right-click the desired disk resource name, click **Properties**, and then click **Details** tab.
3. In the **Details** tab, you can display and/or change the settings by following the description below.

Disk Resource Properties: Details tab

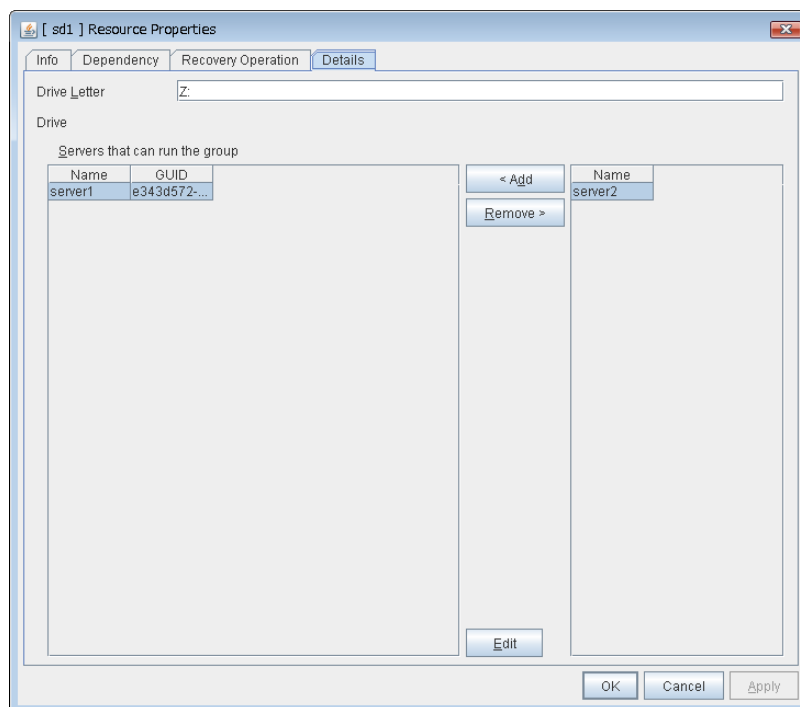

Drive Letter Within 1023 bytes **SuspendResume** **GroupStopRestart**

Specify the drive letter (A to Z) for the disk to be used.

Add **SuspendResume** **GroupStopRestart**

Use this button to add a server to **Servers that can run the group**. The list of added server partitions is displayed in the **Selection of Partition** dialog box.

Remove **SuspendResume** **GroupStopRestart**

Use this button to delete a server from **Servers that can run the group**.

Edit **SuspendResume** **GroupStopRestart**

The **Selection of Partition** dialog box of the selected server is displayed.

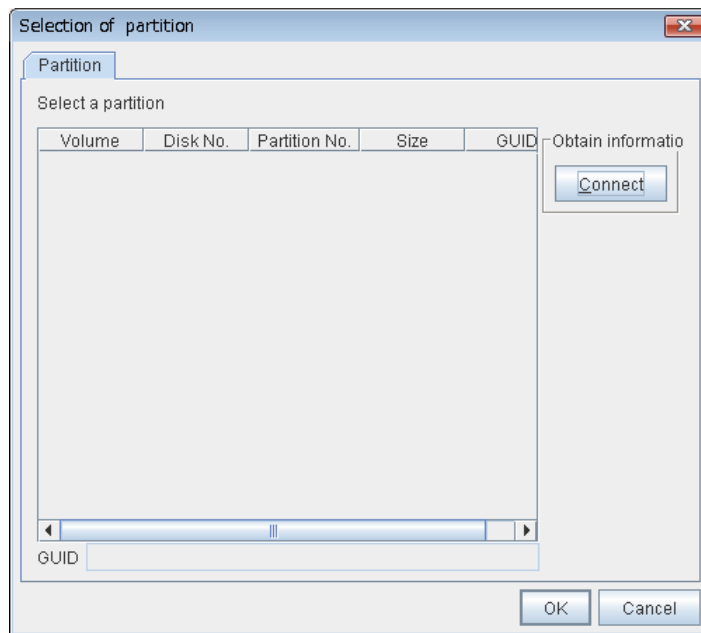

- ◆ **Selection of Partition**
Select the partition to be used as switching partition from the list. GUID of the selected switching partition is displayed. GUID is an identifier used to uniquely identify partitions.
- ◆ **Connect**
Connects to the server and obtain the list of partitions.

Important:

For a partition specified by disk resource, specify the partition on the shared disk that is connected to the filtering configured HBA.

Make sure not to specify a partition specified by disk resource to partition for disk heartbeat resource, or cluster partition or data partition for mirror disk resource. Data on the shared disk may be corrupted.

Displaying the disk resource properties with the WebManager

1. Start the WebManager (*http://Management IP address or the IP address of the cluster server: port_number* (the default value is 29003)).
2. Click an object for a disk resource  in the tree view. The following information is displayed in the list view.

Disk Name: sd1		Details
<div style="display: flex; justify-content: space-between;"> Common server1 server2 </div>		
Properties	Value	
Comment		
Drive Letter	X:	
Status	Offline	
Started Server		

Comment:	Comment
Drive Letter:	Drive letter of switching partition
Status:	Status of disk resource
Started Server:	The server which the resource has started

If you click **Details**, the following information is displayed.

Properties	Value
Name	sd1
Type	sd
Failover Target Server	Stable Server
Failover Threshold	Number of Servers
Retry Count at Activation Failure	3
Final Action at Activation Failure	No operation (not activate next resource)
Execute Script before Final Action	Off
Retry Count at Deactivation Failure	0
Final Action at Deactivation Failure	No operation (not deactivate next resource)
Execute Script before Final Action	Off
Dependent Resources	
Retry Interval at Activation Failure	5
Retry Interval at Inactivation Failure	5

Name:	Disk resource name
Type:	Resource type
Failover Target Server:	Determination method of failover target server
Failover Threshold:	The number of failovers to be made at detection of an error
Retry Count at Activation Failure:	The number of times activation is retried when an activation error is detected
Final Action at Activation Failure:	Final action at an activation error
Execute Script before Final Action:	Whether or not script is executed upon activation failure
Retry Count at Deactivation Failure:	The number of times deactivation is retried when a deactivation error is detected
Final Action at Deactivation Failure:	Final action at a deactivation error
Execute Script before Final Action:	Whether or not script is executed upon deactivation failure
Dependent Resources:	Dependent resource
Retry Interval at Activation Failure:	Activation retry interval
Retry Interval at Inactivation Failure:	Deactivation retry interval

Understanding service resources

You can register services managed by EXPRESSCLUSTER and run when starting, stopping, failing over, or moving groups in EXPRESSCLUSTER. It is also possible to register your own services to service resources.

Dependencies of service resources

By default, this function depends on the following group resource types.

Group resource type
Floating IP resource
Virtual IP resource
Virtual computer name resource
Disk resource
Mirror disk resource
Hybrid disk resource
Print spooler resource
Registry synchronization resource
CIFS resource
NAS resource
AWS elastic ip resource
AWS virtual ip resource
Azure probe port resource

Service resources

A service resource refers to a service managed by the OS service control manager.

Notes on service resources

- Service executed in service resource must be installed on all servers in failover policy.
- Generally, the service executed by the service resource is set to manual start. In case of the service which is executed by automatic start or the service which may be executed by other than the service resource, it is necessary to check on **Do not assume it as an error when the service is already started** which is described below in **Service** tab of **Service resource tuning properties**. If this check box is off, activation fails when executing service start processing by the service resource to the service which has already been executed.
- The service executed by the service resource is not controlled by applications other than EXPRESSCLUSTER. Therefore, it is recommended to set the recovery operation not to be performed by the service control manager.
If a service is set to restart upon the recovery operation by the service control manager, an unexpected action might be performed due to duplication with the recovery operation by EXPRESSCLUSTER.

Displaying and changing the details of service resource

1. From the tree view displayed on the left pane of the Builder, click the icon of the group to which the service resource whose detailed information you want to display and/or change belongs.
2. The group resource list is displayed in the table view in the right pane of the window. Right-click the desired service resource name, click **Properties**, and then click **Details** tab.
3. On **Details** tab, you can display and/or change the settings by following the description below.

Service resource details tab

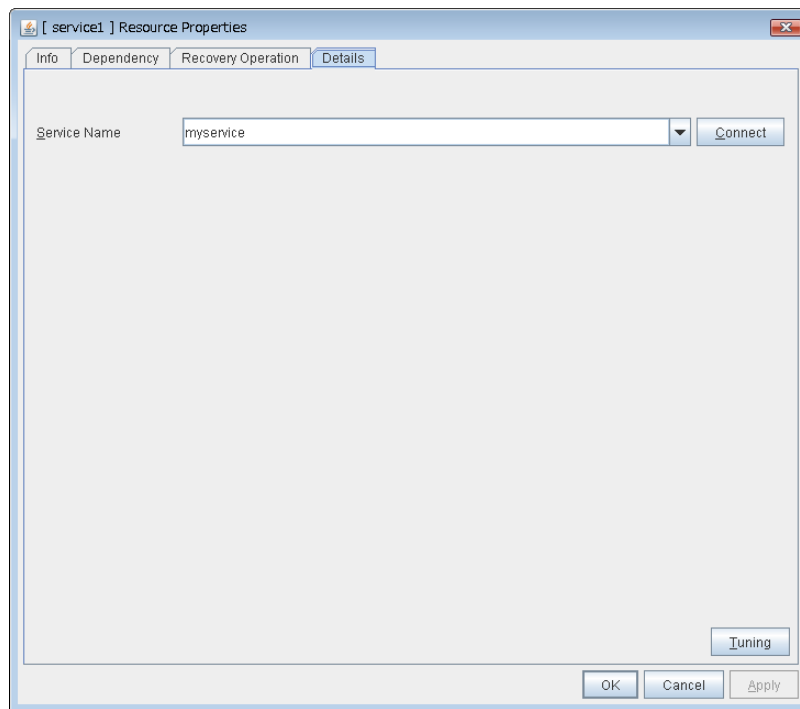

Service Name Within 1023 bytes **GroupStopRestart**

Specify the service name or service display name used in the service resource.

Combo box options display the list of the service display names of the services collected from the server.

Connect

Collects the service list from all the servers and updates the service display name list to be displayed in the **Service Name** combo box.

Tuning

Use this button to display the **Service Resource Tuning Properties** dialog box. You can make advanced settings for the service resource.

Service resource tuning properties

Parameter tab

The detailed setting for parameters is displayed.

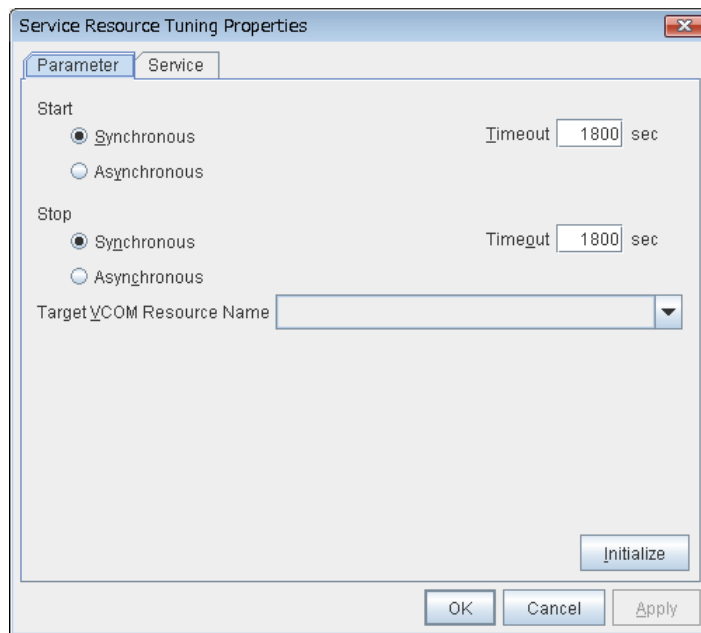

Synchronous

When the service is started up, it waits for “Started.” Typically, the status changes from “Stopping” to “Started” when the service is started.

When stopping the service, it waits for that the status of service becomes “Stopped.” Typically, the status changes from “Stopping” to “Stopped” when the service is stopped.

Asynchronous

No synchronization is performed.

Timeout (1 to 9999) **SuspendResume**

Specify the timeout for the status of the service to become “Started” at the time starting the service. The timeout can be specified only when **Synchronous** is selected. If the status of the service does not change to “Started” within the timeout, it is determined as an error.

Specify the timeout for the stats of the service to become “Stopped” at the time stopping the service. The timeout can be specified only when **Synchronous** is selected. If the status of the service does not change to “Stopped” within the timeout, it is determined as an error.

Target VCOM Resource Name **GroupStopRestart**

Configure this to use a virtual computer name as a computer name used for the service resource. The virtual computer name and resource name that exist in a failover group which the service resource belongs to are listed.

When you specify this parameter, add the following registry and then start the service:

Key name

```
HKEY_LOCAL_MACHINE\SYSTEM\CurrentControlSet\Services\

```

Value

```
Name : Environment
```

```
Type : REG_MULTI_SZ
```

```
Data : COMPUTERNAME=<virtual computer name>
```

```

_CLUSTER_NETWORK_FQDN_=<virtual computer name>
_CLUSTER_NETWORK_HOSTNAME_=<virtual computer name>
_CLUSTER_NETWORK_NAME_=<virtual computer name>

```

Initialize

Click **Initialize** to reset the values of all items to their default values.

Service tab

The settings for the service are displayed.

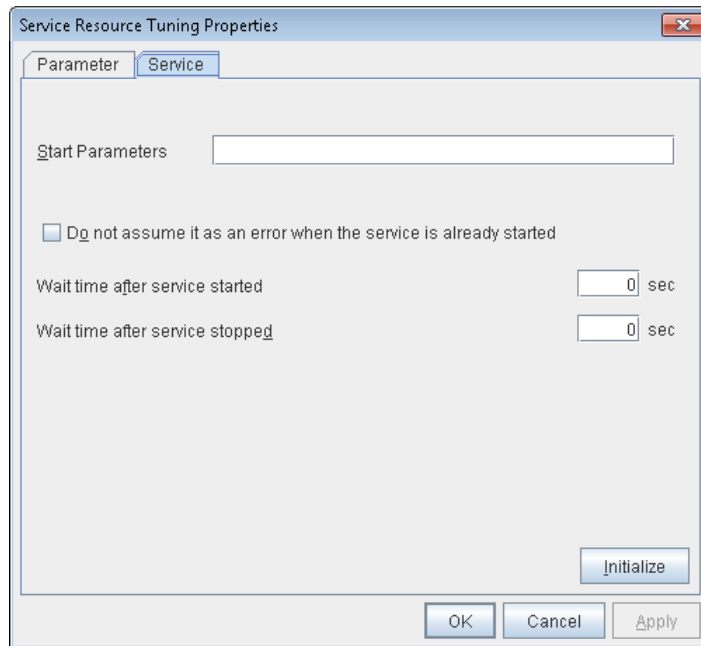

Start Parameters Within 1023 bytes **GroupStopRestart**

Specify a parameter for the service. When there are multiple parameters, leave a space between parameters. For a parameter that includes a space, enclose the parameter by double quotation marks. Note that backslash \ cannot be used.

Example: “param 1” param2

Do not assume it as an error when the service is already started **GroupStopRestart**

- When the checkbox is selected:
When the service is started, if the service is already started up, activation status is kept.
- When the checkbox is not selected:
When the service is started, if the service is already started up, it is considered as activation error.

Wait time after service started (0 to 9999)

Specify the time to wait after the service is started.
The service resource activation will be completed after waiting for the specified time.

Wait time after service stopped (0 to 9999)

Specify the time to wait after the service is stopped.
The service resource deactivation will be completed after waiting for the specified time.

Initialize

Click **Initialize** to reset the values of all items to their default values.

Note:

When **Do not assume it as an error when the service is already started** is selected, service resources that have the same service name can be registered to multiple groups. In this case, do not configure Target VCOM Resource Name. If it is configured, status of service resources becomes abnormal when multiple groups are started on one server.

However, if service resources with the same name are specified for multiple groups and the following operation is performed, the service monitor resource detects an error and a failover may occur.

- When multiple failover groups to which service resources controlling the same service are registered have been activated on the same server and the failover group that started the service first is stopped or moved to another server.

Displaying the service resource properties with the WebManager

1. Start the WebManager (*http://Management IP address or the IP address of the cluster server: port_number* (the default value is 29003)).
2. Click an object for service resource  in the tree view. The following information is displayed in the list view.

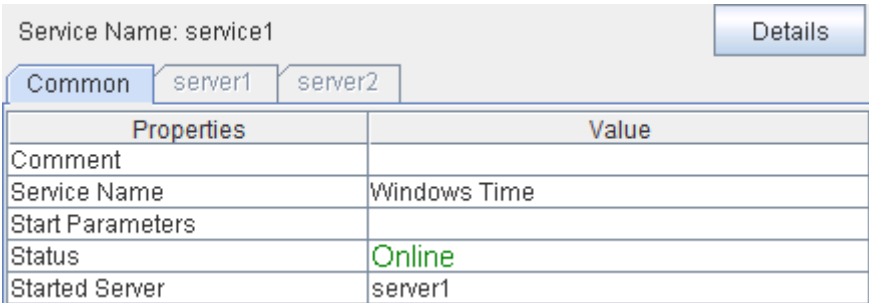

The screenshot shows a web interface for service resource management. At the top, it says 'Service Name: service1' with a 'Details' button. Below that are tabs for 'Common', 'server1', and 'server2'. A table displays the properties and values for the selected service resource.

Properties	Value
Comment	
Service Name	Windows Time
Start Parameters	
Status	Online
Started Server	server1

- Comment: Service resource comment
- Service Name: Service name for the service resource
- Start Parameters: Start parameter of the service
- Status: Status of the service resource
- Started Server: The server which the resource has started

If you click **Details**, the following information is displayed in the pop-up dialog.

Properties	Value
Name	service1
Type	service
Failover Target Server	Stable Server
Failover Threshold	Number of Servers
Retry Count at Activation Failure	0
Final Action at Activation Failure	No operation (not activate next resource)
Execute Script before Final Action	Off
Retry Count at Deactivation Failure	0
Final Action at Deactivation Failure	No operation (not deactivate next resource)
Execute Script before Final Action	Off
Dependent Resources	
Retry Interval at Activation Failure	5
Retry Interval at Inactivation Failure	5
When service has already started, the error is not caus...	No
Target VCOM Name	
[Start]Type	Synchronous
[Start]Timeout (seconds)	1800
[Stop]Type	Synchronous
[Stop]Timeout (seconds)	1800
[Start]Wait Time(seconds)	0
[Stop]Wait Time(seconds)	0

Name:	Service resource name
Type:	Resource type
Failover Target Server:	Determination method of Failover Target Server
Failover Threshold:	The number of failovers to be made at detection of an error
Retry Count at Activation Failure:	The number of times activation is retried when an activation error is detected
Final Action at Activation Failure:	Final action at an activation error
Execute Script before Final Action:	Whether or not script is executed upon activation failure
Retry Count at Deactivation Failure:	The number of times deactivation is retried when a deactivation error is detected
Final Action at Deactivation Failure:	Final action when a deactivation error is detected
Execute Script before Final Action:	Whether or not script is executed upon deactivation failure
Dependent Resources:	Dependent resources
Retry Interval at Activation Failure:	Activation retry interval
Retry Interval at Inactivation Failure:	Deactivation retry interval
When service has already started, the error is not caused:	Check the status of the service when starting the service.
Target VCOM Name:	VCOM name that the service uses
[Start]Type:	Type of execution when the service is started
[Start]Timeout (seconds):	Timeout for the service start (seconds)
[Stop]Type:	Type of execution when stopping the service
[Stop]Timeout (seconds):	Timeout for the service stop (seconds)
[Start]Wait Time (seconds):	Wait time when the service is started (seconds)
[Stop]Wait Time (seconds):	Wait time when the service is stopped (seconds)

Understanding print spooler resources

Dependencies of print spooler resources

By default, this function depends on the following group resource types.

Group resource type
Disk resource
Mirror disk resource
Hybrid disk resource

Print spooler resources

Print spooler resources make the printer functions failover by creating a spool directory on the partition of the disk resource or mirror disk resource.

Notes on print spooler resources

- All servers should use the same printer name, same port and same shared name in their printer definitions and configure the settings for local printer.
- Set the spool directory on a partition of a disk resource or mirror disk resource because the printer spool directory should fail over.
- In case that fail over occurred, because the spooler service is stopped on the waiting server, not printed data may remain in the printer device depending on the stop timing of the spooler service. If printing is continued from the fail over destination, data printing may be invalid because of the not printed data remain in the printer device. Use the fail over target printer device only from the operating server.
- In case using the printer device directly connected to the basic processing device as the fail over target printer device, set the status of the printer device connected to the waiting server "not in use."
- In case that using the fail over target printer device from the waiting server is necessary, create a new printer and use the printer as a different printer name from the fail over target printer. Printing operation is not guaranteed when using the fail over target printer. Configure and operate the printer referring to the following chart.

	Configured automatically printing out to the printer device.		Not configured automatically printing out to the printer device.
	printer directly connected to the basic processing device	printer directly connected to the network (*)	printer directly connected to the basic processing device
Printing only from the operating server	Auto switching enabled. (1)	Auto switching enabled. (2)	Auto switching enabled. (1)
Printing also from the waiting server	Auto switching enabled. (3)	Auto switching enabled. (3)	Auto switching not enabled. (4)

Notes: * Automatic printing out should be enabled because automatic printing out setting is enabled with printer devices which can be connected to the network.

- ✧ **Auto switching enabled. (1)**
Automatic printing at fail over is enabled.
 - ✧ **Auto switching enabled. (2)**
Configuring automatic printing out to the printer device, resuming printing after automatic printing out from the printer device and automatic printing at fail over are enabled.
 - ✧ **Auto switching enabled by scripts. (3)**
Resuming printing after automatic printing out from the printer device and automatic printing at fail over are enabled.
 - ✧ **Auto switching not enabled. (4)**
Automatic printing cannot be executed at fail over because not printed data may remain in the printer device and the characters may be invalid. Reset the printer device manually at fail over and start the spooler service on command prompt or control panel.
- ◆ After the error is deleted from the operating server, by re-combining the server to the cluster and restarting the cluster, the status of the documents which are the print share target of the waiting server before fail over and have been output to the printer spool become as follows.

	Printing from the server AP	Printing from the client AP
Windows 2003	Stop printing at failover, restart printing when the cluster returns.	Stop printing at failover, restart printing when the cluster returns.
Windows 2008		
Windows 2012		

- ◆ The documents which were being printed on the operating server are printed on the waiting server by fail over occurrence. This time, the pages which have already been printed on the operating server are printed again because the printing starts from the top page of the documents on the waiting server. Also, the printing of the documents which were being printed to the printer which is not registered to the cluster on the waiting server starts from the top of the document at fail over.
- ◆ The maximum number of printers which can be registered to one cluster system is 128.
- ◆ If the printer is not recognized, resource activation may fail. The printer is recognized by using the Print Spooler service. Therefore, make sure that the Print Spooler service has started and then specify Auto for the startup type.
- ◆ When the cluster is started by starting the OS, the print spooler resource starts before the printer is recognized, depending on the OS and cluster processing timing. This may lead to a resource activation failure. Should this event occur, set a value of 1 or more for Retry Count at Activation Failure.

Displaying and changing the details of print spooler resources

1. From the tree view displayed on the left pane of the Builder, click the icon of the group to which the print spooler resource whose detailed information you want to display and/or change belongs.
2. The group resource list is displayed in the table view in the right pane of the window. Right-click the desired print spooler resource name, click **Properties**, and then click **Details** tab.
3. On **Details** tab, you can display and/or change the settings by following the description below.

Spool resource properties: Details tab

Printer Name Within 220 bytes **Suspend/Resume**

Specify the printer name to be used.

Partition Within 7 bytes **Suspend/Resume**

Select a drive letter for the spool directory. Select a drive letter on disk resource or mirror disk resource.

Spool Directory Within 244 bytes **Suspend/Resume**

Specify a path for the spool directory. Specify a path after the drive letter starting with a back slash \.

Example: \PRINTER\SPOOL

Displaying the print spooler resource properties with the WebManager

1. Start the WebManager (*http://Management IP address or the IP address of the cluster server: port_number* (the default value is 29003)).
2. Click an object for print spooler resource  in the tree view. The following information is displayed in the list view.

Print Spooler Name: spool1		Details
Common server1 server2		
Properties	Value	
Comment		
Printer Name	printer1	
Partition	M:	
Spool Directory	\spool	
Status	Online	
Started Server	server1	

Comment: Print spooler resource comment
Printer Name: Printer name used for the print spooler resource
Partition: Partition for the spooler directory
Spool Directory: Spooler directory
Status: Status of the print spooler resource
Started Server: The server which the resource has started

If you click **Details**, the following information is displayed in the pop-up dialog.

Properties	Value
Name	spool1
Type	spool
Failover Target Server	Stable Server
Failover Threshold	Number of Servers
Retry Count at Activation Failure	0
Final Action at Activation Failure	No operation (not activate next resource)
Execute Script before Final Action	Off
Retry Count at Deactivation Failure	0
Final Action at Deactivation Failure	No operation (not deactivate next resource)
Execute Script before Final Action	Off
Dependent Resources	md1
Retry Interval at Activation Failure	5
Retry Interval at Inactivation Failure	5

Name: Print spooler resource name
Type: Resource type
Failover Target Server: Determination method of Failover Target Server
Failover Threshold: The number of failovers to be made at detection of an error
Retry Count at Activation Failure: The number of times activation is retried when an activation error is detected
Final Action at Activation Failure: Final action at an activation error
Execute Script before Final Action: Whether or not script is executed upon activation failure
Retry Count at Deactivation Failure: The number of times deactivation is retried when a deactivation error is detected
Final Action at Deactivation Failure: Final action when a deactivation error is detected

Execute Script before Final Action:	Whether or not script is executed upon deactivation failure
Dependent Resources:	Dependent resources
Retry Interval at Activation Failure:	Activation retry interval
Retry Interval at Inactivation Failure:	Deactivation retry interval

Understanding virtual computer name resources

Dependencies of virtual computer name resources

By default, this function depends on the following group resource types.

Group resource type
Floating IP resource
Virtual IP resource
AWS elastic ip resource
AWS virtual ip resource
Azure probe port resource

Virtual computer name resources

Client applications can be connected to a cluster server by using a virtual computer name. The servers can be connected to each other by using a virtual computer name. By using a virtual computer name, switching from one server to the other to which a client is connecting remains transparent even if failover or moving of a failover group occurs.

Only client applications on Windows machine can connect to the cluster server by a virtual computer name.

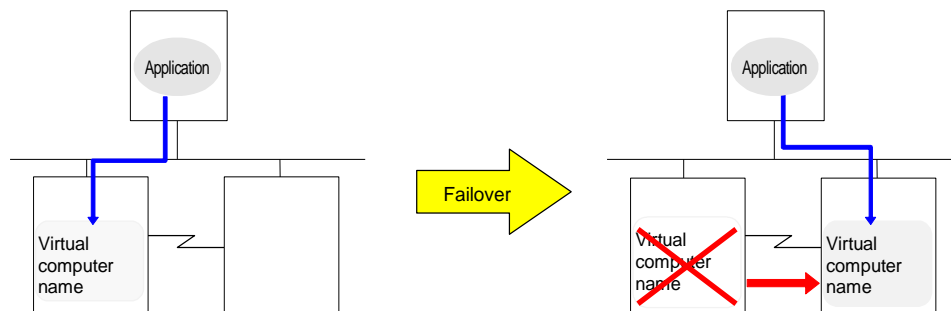

Determining virtual computer name

A computer name used as a virtual computer name should satisfy the following conditions:

- ◆ The name should be different from cluster server names.
- ◆ The name should be different from any computer names of machines connected to the same network segment.
- ◆ The name should be within 15 characters.
- ◆ The name should consist of letters from alphabet, numbers, and/or hyphen.
- ◆ The name is not case-sensitive.

Linking virtual computer name and floating IP address

Once a virtual computer name is linked with a floating IP address, the combination of the virtual computer name and floating IP address can be written to the client's LMHOSTS file. To configure this, use the Builder. Select **Virtual Computer Name Resource Properties**, and click **Details** tab, and then click **Target FIP Resource Name**. This configuration allows using the virtual computer name from a remote LAN.

If the virtual computer name and floating IP address are not linked, the virtual computer name cannot be used from a remote LAN by using LMHOSTS file. In this case, virtual computer name needs to be registered to DNS dynamically, or WINS needs to be set to use virtual computer names from a remote LAN. For information on how to configure WINS, refer to the next section "Configuring WINS server."

Configuring WINS server

To use a virtual computer name from a remote LAN without linking the virtual computer name to a floating IP address, set the WINS server as follows:

- ◆ When installing the WINS server to cluster servers
 1. Install the WINS server on all servers in a cluster. If you are prompted to reboot the servers after installation, click **No**.
 2. Configure the settings described from step 3 to 6 on all cluster servers.
 3. Open Control Panel and double-click Network Connections. Double-click Local Area Connection and open Local Area Connection Properties.
 4. Click Internet Protocol (TCP/IP) and click Properties.
 5. Click **Advanced** and click **WINS** tab.
 6. Add the IP addresses of public LAN in all servers in a cluster to the WINS address (The order of usage does not matter.)
 7. Shut down and reboot the cluster.
 8. Install the WINS server on the client on a remote LAN by following the same steps.
- ◆ When setting the WINS server on a server other than a cluster server
 1. Install WINS server on a server other than a cluster server.
 2. Open Control Panel and double-click Network Connections. Double-click Local Area Connection and open Local Area Connection Properties.
 3. Click Internet Protocol (TCP/IP) and click Properties.
 4. Click **Advanced** and click **WINS** tab.
 5. In **WINS addresses**, add the IP addresses of WINS server.
 6. Repeat the steps above for all servers in the cluster.
 7. Shut down and reboot the cluster.
 8. Install the WINS server to the client on a remote LAN by following the same steps.

Appropriate use of virtual computer name resources and dynamic DNS resources

Virtual computer name resources use an old protocol. Dynamic DNS resources are recommended for the latest OS.

When you use one of the following OSs and if a DDNS server is available, use dynamic DNS resources. In other cases, use virtual computer name resources.

Virtual computer name resources cannot be used together with dynamic DNS resources.

- Windows Server 2008 R2(x86_64 version)
- Windows Server 2012(x86_64 version)
- Windows Server 2012 R2(x86_64 version)
- Windows Server 2016(x86_64 version)

Services available to the virtual computer name

The following services are available to the virtual computer name:

Service	FIP linked		FIP not linked	
	In x32	In x64	In x32	In x64
TCP/IP name resolution (from computer name to IP address)	Yes	Yes	Yes	No
Network drive connection	Yes	Yes	Yes	Yes
Network printer connection	Yes	Yes	Yes	Yes
Pipe with the name	Yes	Yes	Yes	Yes
RPC (pipe with the name)	Yes	Yes	Yes	Yes
RPC (TCP/IP)	Yes	Yes	Yes	No

Notes on virtual computer name resources

- Create a virtual computer name control process (clpvcomp.exe) per virtual computer name resource to be activated. Make sure not to stop the process by mistake. An error of process disappearance can be detected by virtual computer name monitoring resources.
- The following services are not available to the virtual computer name:
 1. Mail slot
 2. RPC (NetBIOS)
- When the virtual computer name and floating IP address are not linked, the following needs to be considered:
 1. In the x64 environment, the following services cannot be used.
 - TCP/IP name resolution (from computer name to IP address)
 - RPC (TCP/IP)
 2. It may take a few minutes to reconnect to the cluster after failover due to a failure of the server.
 3. It may take a few minutes to display the virtual computer name in the network computer after the cluster is started.

4. The virtual computer name cannot be written to LMHOSTS.
 5. When you have the settings to use a DNS server and the DNS server is associated with WINS, switching by failover cannot be done while cache information of the virtual computer name remaining on the DNS server. Configure the time to retain cache for WINS to approximately 1 second on the DNS server.
- If the virtual computer name and floating IP address are linked, the following need to be considered:
 1. The NetBEUI protocol cannot be used. To use the NetBEUI protocol, cancel the linkage.
 2. The virtual computer name is valid with the network address of the linked floating IP. To use the virtual computer name from a network address other than that of the linked floating IP, perform one of the following operations:
 - Register the name with DNS dynamically.
 - Enter a combination of the virtual computer name and floating IP address in LMHOSTS.
 - Configure the WINS server.
 3. Multiple virtual computer names cannot be linked to the same floating IP.
 4. When different floating IPs exist on one or more public LAN, for using the same virtual computer name on each LAN, activation and deactivation processing needs to be executed sequentially by creating virtual computer name resource corresponding to each floating IP and setting dependency relation between these resources.
 - To register a virtual computer name with the WINS server on a remote network, configure the following settings in cluster servers:
 1. Open **Control Panel**, and double-click **Network Connections**
 2. From the menu, click **Advanced**, and then click **Advanced Settings**. Select **Adapters and Bindings** tab.
 3. Change the order of the BindPath. The public LAN (the network adapter with which the WINS server address is registered) should be on the top. **Adapters and Bindings** tab should look similar to the following:

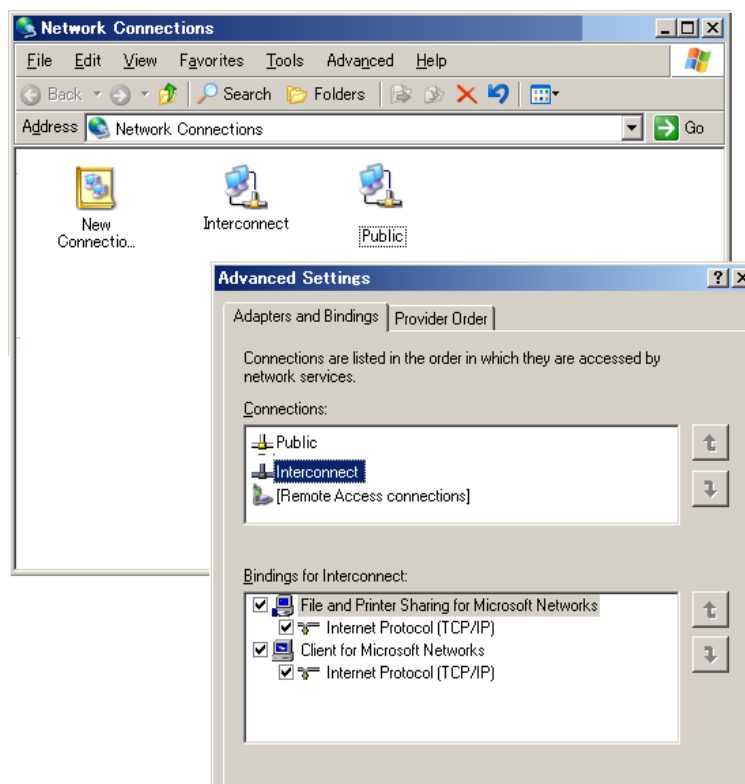

- The communication by file sharing protocol (SMB/CIFS) using a virtual computer name owned by an activated group on the active server may fail due to an authentication error.

(Example 1)

The Explorer is started in the server where the group is active and the following address is entered in the address bar. However it results in causing an authentication error and cannot open the shared folder.

<Virtual computer name>/shared name

(Example 2)

In a server where the group was active, started the registry editor and specified the virtual computer name in “Connect Network Registry,” but failed due to authentication error.

<**Troubleshooting**>

1. Verify that the all servers are properly working from the WebManager.
2. Execute Steps 3 to 7 below in each server in the cluster.
3. From the **Start** menu, select **Run**, and run regedit.exe and add the following registry value:
 HKEY_LOCAL_MACHINE\SYSTEM\CurrentControlSet\Services\lanmanserver\parameters
 Name (Type):
 DisableStrictNameChecking (DWORD type)
 Value:
 0x1
4. If the following value exists in the following key, delete it:
 Key:
 HKEY_LOCAL_MACHINE\SYSTEM\CurrentControlSet\Control\Lsa\MSV1_0
 Name (Type):
 BackConnectionHostNames (DWORD type)
5. Create a new multi-line string value for the same the name in Step 4 (BackConnectionHostNames), and set a virtual computer name.
 (Example) when there are two virtual computer names: vcom1 and vcom2

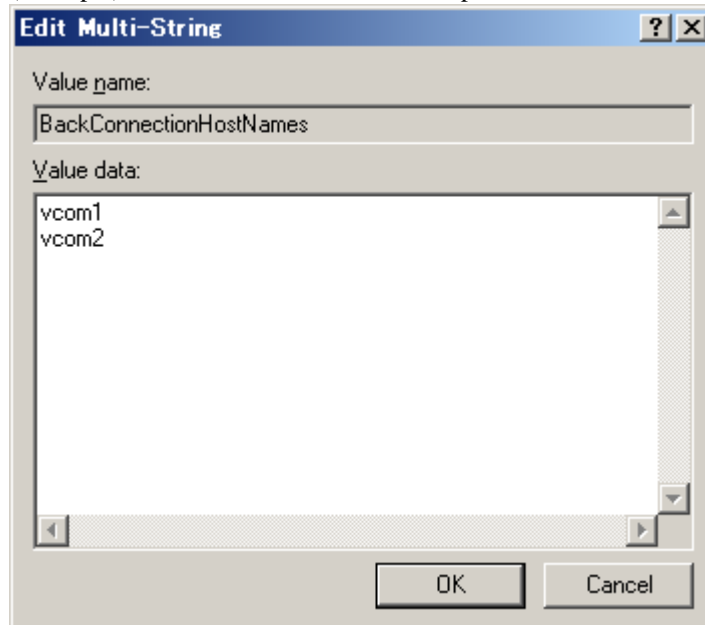

6. Close the registry editor.

7. (applicable only when the virtual computer name and the floating IP address are linked)
In the system drive: \Windows\system32\drivers\etc\hosts, add an entry of the virtual computer name (not FQDN name but computer name only) and the linked floating IP address. When there are multiple virtual computer names linked with floating IP address, add entries for all of them.

(Example) when the virtual computer name is “vcom1” and the linked floating IP address is “10.1.1.11”:

Add the following to the hosts file: 10.1.1.11 vcom1

8. Execute Steps 3 to 7 above in all servers. Then shut down the cluster and reboot all servers.

- Notes on registering a virtual computer name with DNS dynamically
 1. Cluster server must be assigned in the domain.
 2. DNS must be configured for the public LAN. EXPRESSCLUSTER registers virtual computer name specified by public LAN with DNS.
 3. DNS registration is performed when virtual computer name resource is activated. Failure of registration will not be recognized as an error.
 4. A virtual computer name is deleted from DNS when virtual computer name resource is deactivated. Failure of deletion will not be recognized as an error.
- On Windows Server 2008/2012/2016, virtual computer name resource cannot be activated on the NIC that LAN cable is not connected.
- When Server service of OS is stopped, virtual computer name resource cannot be activated. If you want to use virtual computer name resource, do not disable/stop Server service.
- If **Secure only** is specified for DNS Dynamic Updates, the **write** and the **delete subtree** permissions must be applied to computer objects in the zone to be updated by a virtual computer name resource. Apply the permissions to **This object and all descendant objects**. For how to apply the permissions, refer to the setting method for the DNS server. The settings above are not required if **Nonsecure and secure** is specified for DNS Dynamic Updates.

Displaying and changing the details of virtual computer name resource

1. From the tree view on the left pane of the Builder, click the group icon where the virtual computer name resource whose details you want to display and/or change belongs.
2. The group resource list is displayed in the table view in the right pane of the window. Right-click the desired virtual computer resource name, click **Properties**, and then click **Details** tab.
3. On **Details** tab, you can display and/or change the settings by following the description below.

Virtual computer name resource details tab

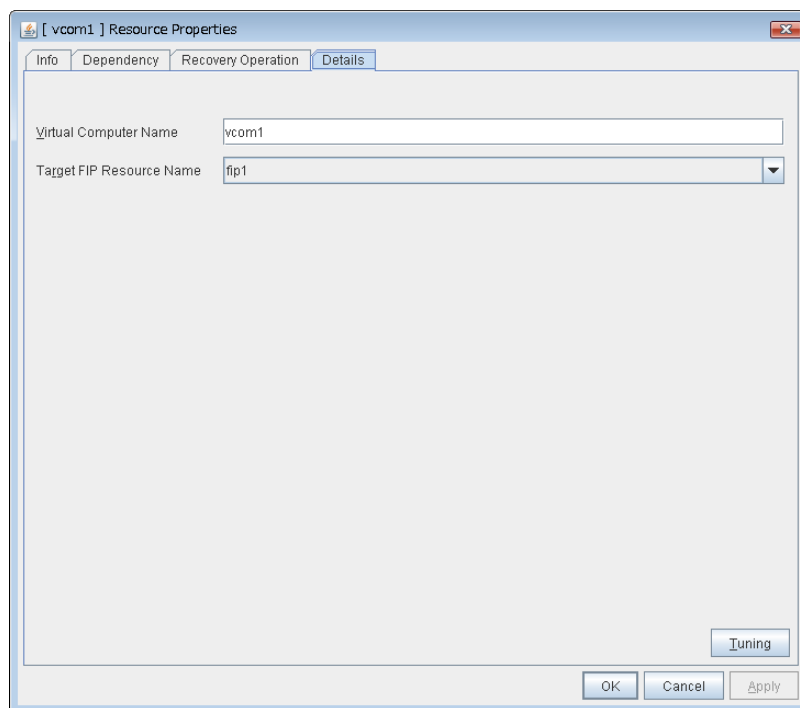

Virtual Computer Name Within 15 bytes **SuspendResume** **GroupStopRestart**

Specify the virtual computer name.

Target FIP Resource Name **SuspendResume** **GroupStopRestart**

Select the floating IP resource name to be linked to the virtual computer name.

Tuning

Display the **VCOM Resource Tuning Properties** dialog box to configure the details of virtual computer name resource.

Virtual Computer Resource Tuning Properties

Parameter tab

Display the details of setting the parameter.

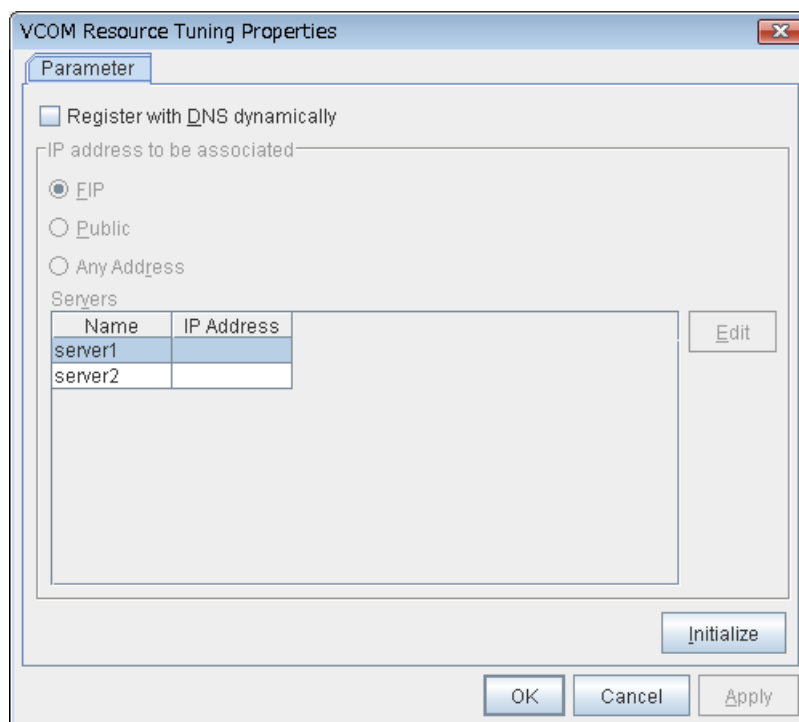

Register with DNS dynamically **SuspendResume** **GroupStopRestart**

Specify whether or not to register with DNS dynamically during activation of resource.

IP address to be associated **SuspendResume** **GroupStopRestart**

Select one of the followings as IP address for registration with DNS dynamically to associate with virtual computer name.

- **FIP**
Associates the floating IP address in selected in the target FIP resources name.
- **Public**
Associates the public LAN address of a server to activate resources.
- **Any Address**
Associates any IP address you want on a server basis.

Edit **SuspendResume** **GroupStopRestart**

When **Any Address** is selected for IP address to be associated, select your target server in **Servers**. Click **Edit** to specify an IP address on a server..

Initialize

Click this button to configure default values for all options.

Displaying the virtual computer name resource properties with the WebManager

1. Start the WebManager (http:// Management IP address or the IP address of the cluster server: port_number (the default value is 29003)).
2. Click an object for virtual computer name resource  in the tree view. The following information is displayed in the list view.

Virtual Computer Name Name: vcom1		Details
Common server1 server2		
Properties	Value	
Comment		
Virtual Computer Name	vcom1	
Target FIP Name	fip1	
Status	Online	
Started Server	server1	

Comment: Comment for the virtual computer name resource
 Virtual Computer Name: Virtual computer name
 Target FIP Name: Floating IP resource to be linked to the virtual computer name
 Status: Status of the virtual computer name resource
 Started Server: The server which the resource has started

If you click **Details**, the following information is displayed in the pop-up dialog.

Properties	Value
Name	vcom1
Type	vcom
Failover Target Server	Stable Server
Failover Threshold	Number of Servers
Retry Count at Activation Failure	5
Final Action at Activation Failure	No operation (not activate next resource)
Execute Script before Final Action	Off
Retry Count at Deactivation Failure	0
Final Action at Deactivation Failure	No operation (not deactivate next resource)
Execute Script before Final Action	Off
Dependent Resources	fip1,vip1
Retry Interval at Activation Failure	5
Retry Interval at Inactivation Failure	5

Name: Virtual computer name resource
 Type: Resource type
 Failover Target Server: Determination method of Failover Target Server
 Failover Threshold: The number of failovers to be made at detection of an error
 Retry Count at Activation Failure: The number of times activation is retried when an activation error is detected
 Final Action at Activation Failure: Final action at an activation error
 Execute Script before Final Action: Whether or not script is executed upon activation failure
 Retry Count at Deactivation Failure: The number of times deactivation is retried when a deactivation error is detected
 Final Action at Deactivation Failure: Final action when a deactivation error is detected
 Execute Script before Final Action: Whether or not script is executed upon deactivation failure
 Dependent Resources: Dependent resources
 Retry Interval at Activation Failure: Activation retry interval
 Retry Interval at Inactivation Failure: Deactivation retry interval

Understanding dynamic DNS resources

Dependency of dynamic DNS resources

By default, dynamic DNS resources depend on the following types of group resources.

Group resource type
Virtual IP resource
Floating IP resource
AWS elastic ip resource
AWS virtual ip resource
Azure probe port resource

Dynamic DNS resources

- ◆ A dynamic DNS resource registers a virtual host name and the IP address of an activated server with the dynamic DNS server (hereafter, DDNS server). A client application can use a virtual host name to access the cluster server. Use of virtual host names allows clients to transparently switch connection from one server to another when a group is “failed over” or “moved”.

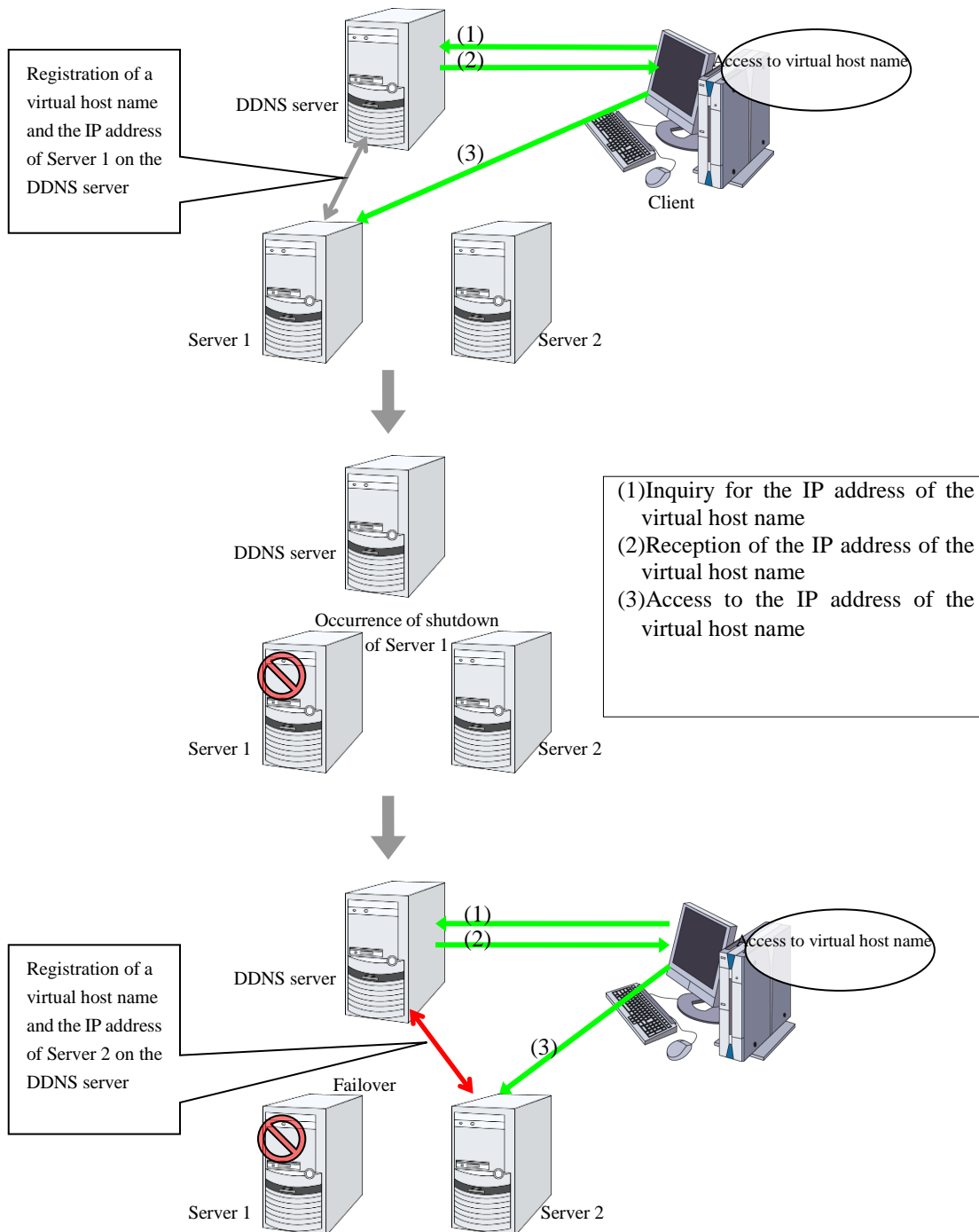

Appropriate use of virtual computer name resources and dynamic DNS resources

Virtual computer name resources use an old protocol. Dynamic DNS resources are recommended for the latest OS.

When you use one of the following OSs and if a DDNS server is available, use dynamic DNS resources. In other cases, use virtual computer name resources.

Virtual computer name resources cannot be used together with dynamic DNS resources.

- Windows Server 2008 R2(x86_64 version)
- Windows Server 2012(x86_64 version)
- Windows Server 2012 R2(x86_64 version)
- Windows Server 2016(x86_64 version)

Preparation for use of dynamic DNS resources

To use dynamic DNS resources, you need to establish a DDNS server in advance. DDNS servers support only active directories.

If using the Kerberos authentication function, you need to make the following setting for the Active Directory domain to be updated by the dynamic DNS resource.

Please give the following permissions to each cluster server.

- **Create All Child Objects**
- **Delete All Child Objects**

Permissions will be applied to, please choose **This object and all child objects**.

If **Secure only** is specified for DNS Dynamic Updates, the write permissions must be applied to cluster servers in the zone to be updated by a virtual computer name resource. Apply the **write** permissions to **This object and all child objects (This object and all descendant objects)** for Windows Vista or later and Windows Server 2008 or later). For how to apply the write permissions, refer to the setting method for the DNS server.

Notes on dynamic DNS resources

- ◆ If **Execute Dynamic Update Periodically** is enabled, a dynamic DNS monitor resource periodically registers a virtual host name to the DDNS server.
- ◆ Create a DDNS control process (clpddnsp.exe) per dynamic DNS resource to be activated. Make sure not to stop the process by mistake. An error of process disappearance can be detected by dynamic DNS monitor resources.
- ◆ When the IP addresses of servers exist in different segments, FIP addresses cannot be specified as the IP addresses of dynamic DNS resources.
- ◆ To register the IP addresses of servers with the DDNS server, make the setting of each IP address separately for each server. Enter the IP address of any server in the **IP Address** box on the **Common** tab and then specify the IP addresses of other servers individually on each server tab.
- ◆ Regarding the settings for each server, if the same virtual host name already exists at

activation, the duplicate virtual host name is temporarily deleted from the primary DNS server and the relevant virtual host name and IP address of the activated server are registered. The setting of the **Delete the Registered IP Address** option, which is a setting applied at deactivation, does not affect this behavior.

- ◆ In client access using a virtual host name, if a group having dynamic DNS resources is failed over, reconnection (e.g. restart of the browser) may be required.
- ◆ Behavior in WebManager connection using a virtual host name
 - When the IP address of each server is separately specified for dynamic DNS resources
In client access using a virtual host name via WebManager connection, if a group having dynamic DNS resources is failed over, the WebManager connection will not be automatically switched. You need to restart the browser and to establish WebManager connection again.
 - When FIP addresses are specified for dynamic DNS resources
In client access using a virtual host name via WebManager connection, if a group having dynamic DNS resources is failed over, the WebManager connection will be automatically switched.

Displaying and changing the details of dynamic DNS resources

1. In the tree view displayed on the left pane of the Builder, click the icon of the group that contains the dynamic DNS resource with detailed information to be displayed and/or changed.
2. The table view in the right pane of the window displays the group resource list. Right-click the desired dynamic DNS resource name, and click the [Details] tab in [Properties].
3. On the [Details] tab, follow the description below to display and/or change the settings.

Dynamic DNS Resource Properties: Details tab

Virtual Host Name (within 253 bytes) **GroupStopRestart**

Specify the virtual host name to be registered in the DDNS service.

IP Address (within 79 bytes) **GroupStopRestart**

Specify the IP address corresponding to the virtual host name.

To use an FIP resource in parallel, specify the IP address of the FIP resource in the [Source IP Address] tab. To use the IP addresses of servers, specify each IP address in the tab of each server.

DDNS Server (within 255 bytes) **GroupStopRestart**

Specify the IP address of the DDNS server. When specifying secondary DNS servers, use a comma (,) for the separator. First, specify the primary DNS server, and then specify secondary DNS servers.

Examples:

To specify only the primary DNS server: 192.168.10.180

To specify two secondary DNS servers:

192.168.10.180,192.168.10.181,192.168.10.182

Port No. (1 to 65535) **GroupStopRestart**

Specify the port number of the DDNS server. Its default value is 53.

Cache TTL (0 to 2147483647) **GroupStopRestart**

Specify the time to live (TTL) of the cache. Its default value is 0 seconds.

Execute Dynamic Update Periodically **GroupStopRestart**

- When the check box is selected (default):
The virtual host name and the IP address of the active server are periodically registered to the DDNS server.
- When the check box is not selected:
The virtual host name and the IP address of the active server are not periodically registered to the DDNS server.

Update Interval (1 to 9999) **GroupStopRestart**

Specify the interval for periodic registration of the virtual host name and the IP address of the activated server with the DDNS server. The default value is 60 minutes. For an internal version of 11.31 or earlier, the unit is seconds and the default value is 60 seconds. Be sure to specify a time shorter than the update interval of the DDNS server.

Delete the Registered IP Address **GroupStopRestart**

- When the check box is selected (default):
When the dynamic DNS resource is deactivated, the virtual host names and the IP addresses of the active servers that were registered to the DNS server are deleted.
- When the check box is not selected:
When the dynamic DNS resource is deactivated, the virtual host names and the IP addresses of the active servers that were registered to the DNS server are not deleted. In this case, a client may be able to access one of these undeleted virtual host names.

Kerberos Authentication **GroupStopRestart**

Specify whether to enable Kerberos authentication in Active Directory. No password need to be specified because a password is automatically generated when a dynamic DNS resource registers a virtual host name in the Active Directory domain. The default is cleared.

- When the check box is selected:
Select the check box to enable Kerberos authentication in Active Directory.
- When the check box is not selected (default):
Clear the check box to disable Kerberos authentication inActive Directory.

Displaying dynamic DNS resource properties with the WebManager

1. Start the WebManager (http://Management IP address or the IP address of the cluster server:port_number (Default value: 29003)).
2. Click a dynamic DNS resource object, [], in the tree view. The following information is displayed in a list view.

Dynamic DNS: ddns1		Details
Common		
server1		
server2		
Properties	Value	
Comment		
Virtual Host Name	ddns1.example.com	
IP Address	192.168.68.10	
Status	Online	
Started Server		

- Comment: Dynamic DNS resource comment
 Virtual Host Name: Virtual host name used by the dynamic DNS resource
 IP Address: IP address used by the dynamic DNS resource
 Status: Status of the dynamic DNS resource
 Started Server: Server that the resource has started

Clicking the [Details] button will allow the following information to be displayed in a pop-up dialog box.

Properties	Value
Name	ddns1
Type	ddns
Failover Target Server	Stable Server
Failover Threshold	0
Retry Count at Activation Failure	1
Final Action at Activation Failure	No operation (not activate next resource)
Execute Script before Final Action	Off
Retry Count at Deactivation Failure	1
Final Action at Deactivation Failure	Stop the cluster service and shutdown OS
Execute Script before Final Action	Off
Dependent Resources	
Retry Interval at Activation Failure	5
Retry Interval at Inactivation Failure	5
DDNS Server	192.168.10.180
Port No.	53
Cache TTL (sec)	0
DNS update interval (sec)	3600
DNS dynamic update	On
DNS registered IP delete	Off
Enable Kerberos Authentication	Off

Name:	Dynamic DNS resource name
Type:	Resource type
Failover Target Server:	Determination method of Failover Target Server
Failover Threshold:	The number of failovers to be made at detection of an error
Retry Count at Activation Failure:	The number of times activation is retried when an activation error is detected
Final Action at Activation Failure:	Final action at an activation error
Execute Script before Final Action:	Whether or not script is executed upon activation failure
Retry Count at Deactivation Failure:	The number of times deactivation is retried when a deactivation error is detected
Final Action at Deactivation Failure:	Final action when a deactivation error is detected
Execute Script before Final Action:	Whether script is executed upon deactivation failure
Dependent Resources:	Dependent resources
Retry Interval at Activation Failure:	Activation retry interval
Retry Interval at Inactivation Failure:	Deactivation retry interval
DDNS Server:	IP address of DDNS server
Port No.:	Port number of DDNS server
Cache TTL (sec):	Cache TTL
DNS update interval (sec):	Update interval for registration with DDNS server
DNS dynamic update:	Whether to update the DDNS server
DNS registered IP delete:	Whether to delete the registered IP addresses when the dynamic DNS resource is deactivated
Enable Kerberos Authentication:	Enable/disable Kerberos authentication

Understanding virtual IP resources

Dependencies of virtual IP resources

By default, this function does not depend on any group resource type.

Virtual IP resources

Client applications can be connected to a cluster server by using a virtual IP address. The servers can be connected to each other by using a virtual IP address. By using a virtual IP address, switching from one server to the other to which a client is connecting remains transparent even if failover or moving of a failover group occurs. The graphic in the next page shows how virtual IP resources work in the cluster system.

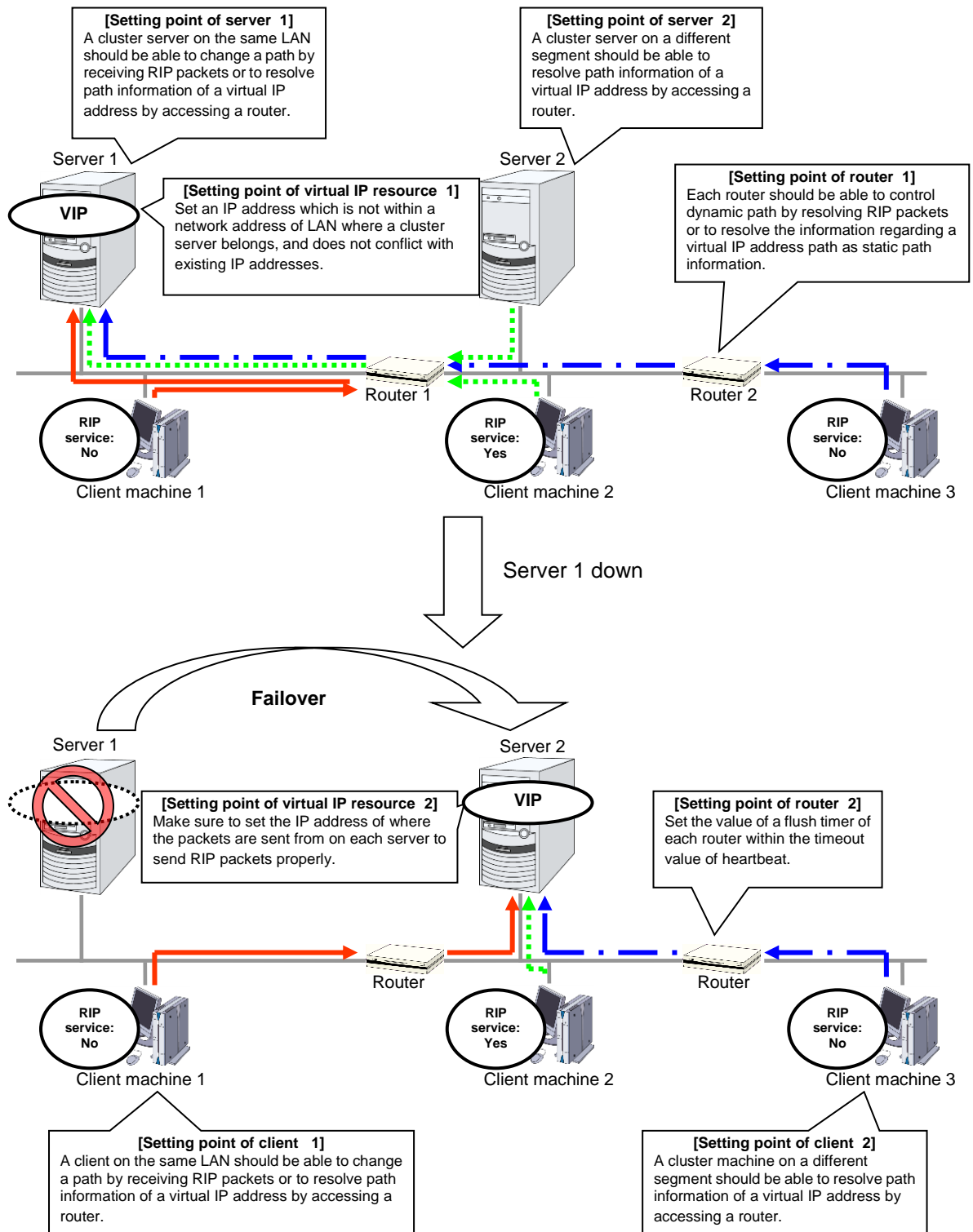

Determining virtual IP address

An IP address used as a virtual IP address should satisfy the following conditions:

- The IP address should not be within the network address of the LAN to which the cluster belongs.
- The IP address should not conflict with existing network addresses.

Select one of the following allocation methods to meet the requirements above:

- Obtain a new network IP address for virtual IP address and allocate virtual IP address.
- Determine a network IP address from private IP address space and allocate virtual IP address. The following procedures are given as an example.
- Select one network address from 192.168.0 to 192.168.255 for virtual IP address.
- Allocate up to 64 host IP addresses for virtual IP address from the network address you have selected. (For example, select the network address 192.168.10 and allocate two host IP addresses: 192.168.10.1 and 192.168.10.254)
- Specify 255.255.255.0 to net mask of the virtual IP address.
- Private IP addresses are addresses for a closed network and they cannot be accessed using virtual IP address from outside of the network through internet providers.
- Do not disclose path information of private IP addresses outside the organization.
- Adjust the private IP addresses to avoid conflict with other address.

Controlling path

To access to a virtual IP address from a remote LAN, path information of the virtual IP address must be effective to all routers on the path from the remote LAN to the LAN for cluster server. To be specific, the following condition must be satisfied:

- Routers on the cluster servers LAN interpret host RIP.
- Routers on the path from a cluster server to the remote server have the dynamic routing settings or information on the virtual IP address routes has configured as static routing settings.

Requirement to use virtual IP address

Environments where virtual IP address can be used

Virtual IP addresses can be accessed from the machines listed below. Virtual IP address mechanism functions properly even in a LAN where switching hubs are used. However, when a server goes down, TCP/IP that has been connected will be disconnected.

When using virtual IP addresses with a switching HUB that cannot be configured to create a host routing table by receiving host RIP, you need to reserve one new network address and configure virtual IP addresses so that the IP address of each server belongs to a different network address.

- **Cluster servers that belong to the same LAN that the server the virtual IP activates belongs to**

Virtual IP addresses can be used if the following conditions are satisfied:

- Machines that can change the path by receiving RIP packets.
- Machines that can resolve the path information of a virtual IP address by accessing a router.

- **Cluster servers that belong to a different LAN that the server the virtual IP activates belongs to**

Virtual IP addresses can be used if the following condition is satisfied:

- Machines that can resolve path information of the virtual IP address by accessing a router.

- **Clients that belong to the same LAN that cluster servers belong to**

Virtual IP addresses can be used if the following conditions are satisfied:

- Machines that can change the path by receiving RIP packets.
- Machines that can resolve the path information of a virtual IP address by accessing a router.

- **Clients on the remote LAN**

Virtual IP addresses can be used if the following condition is satisfied:

- Machines that can resolve path information of the virtual IP address by accessing a router.

Notes on virtual IP resources

Virtual IP addresses do not support NetBIOS protocol.

- Even if you map a virtual IP address to a host name using LMHOSTS, it cannot be used for accessing and user authentication for Windows browsing, networks, and printer resources.
- Use a virtual computer name to automatically switch the connection destination with the NetBIOS protocol.

The following rule applies to virtual IP addresses.

- The number of a virtual IP resource to be registered on one cluster system is up to 64.
- To use a virtual IP resource, the names of a cluster, server and group need to be set according to the naming rules of Ver8.0 or earlier.

Adjust the value of the flush timer of the router within the value for heartbeat timeout. For the heartbeat timeout, see “Cluster properties Timeout tab” in Chapter 2, “Functions of the Builder” in this guide.

For Windows Server 2008, it is necessary to add the Routing and Remote Access service to each cluster server to enable the LAN routing. This is not required when the interconnect LAN with the highest priority is common to public LAN.

When an IPv6 address is used as a virtual IP address in Windows Server 2003, it is necessary to specify public LAN as the interconnect with the highest priority.

If the routing protocol is set to “RIPver2,” the subnet mask for transmitted RIP packets is “255.255.255.255.”

Displaying and changing the details of virtual IP resource

1. From the tree view on the left pane of the Builder, click the group icon where the virtual IP resources whose details you want to display and/or change belong.
2. The group resource list is displayed in the table view in the right pane of the window. Right-click the desired virtual IP resource name, click **Properties**, and then click **Details** tab.
3. On **Details** tab, you can display and/or change the settings by following the description below.

Virtual IP resource details tab

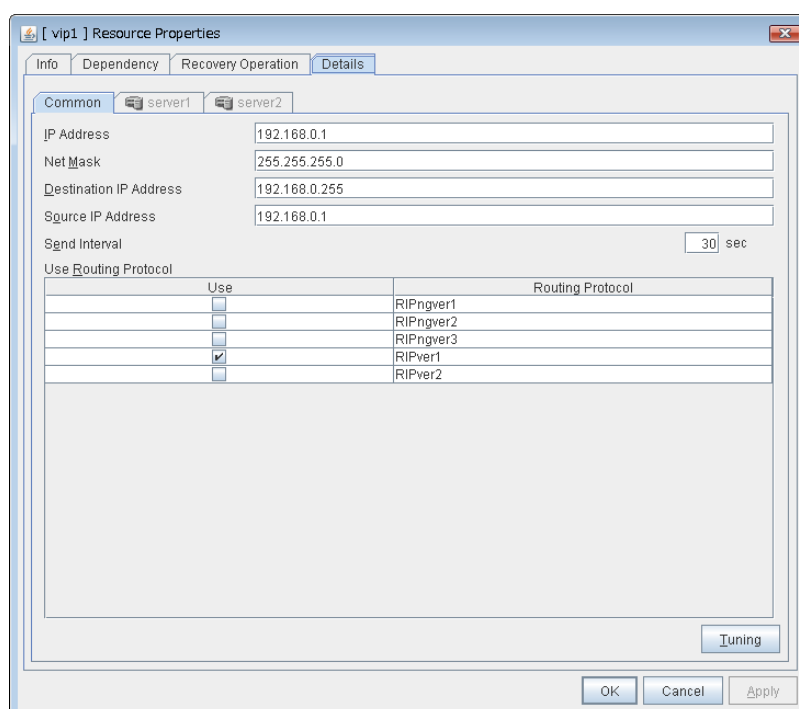

IP Address (within 45 bytes) **GroupStopRestart**

Enter the virtual IP address to use.

Net Mask (within 45 bytes) **GroupStopRestart**

Specify the net mask of the virtual IP address to use. It is not necessary to specify it when the IPv6 address is specified as a virtual IP address.

Destination IP Address (within 45 bytes) **GroupStopRestart**

Enter the destination IP address of RIP packets. The broadcast address of the LAN where the cluster server belongs is specified for IPv4 and the IPv6 address of the router of the LAN where the cluster server belongs is specified for IPv6.

Source IP Address (within 45 bytes) **GroupStopRestart**

Enter the IP address to bind for sending RIP packets. Specify the actual IP address activated on NIC which activates the virtual IP address.

When using an IPv6 address, specify a link local address as the source IP address.

Note: The source IP address should be set on a server basis, and set the actual IP address of each server. Virtual IP resources do not operate properly if a source address is invalid.

In the [common] tab, described the Source IP Address of any of the server, the other server, please to perform the individual settings.

Send Interval (1 to 30) ~~GroupStopRestart~~

Specify the send interval of RIP packets.

Use Routing Protocol ~~GroupStopRestart~~

Specify the RIP version to use. For IPv4 environment, select RIPver1 or RIPver2. For IPv6 environment, select RIPngver1 or RIPngver2 or RIPngver3. You can select one or more routing protocol.

Tuning

Use this button to display the **Virtual IP Resource Tuning Properties** dialog box. You can make advanced settings for the virtual IP resource.

Virtual IP Resource Tuning Properties

Parameter tab

Detailed setting for parameter is displayed.

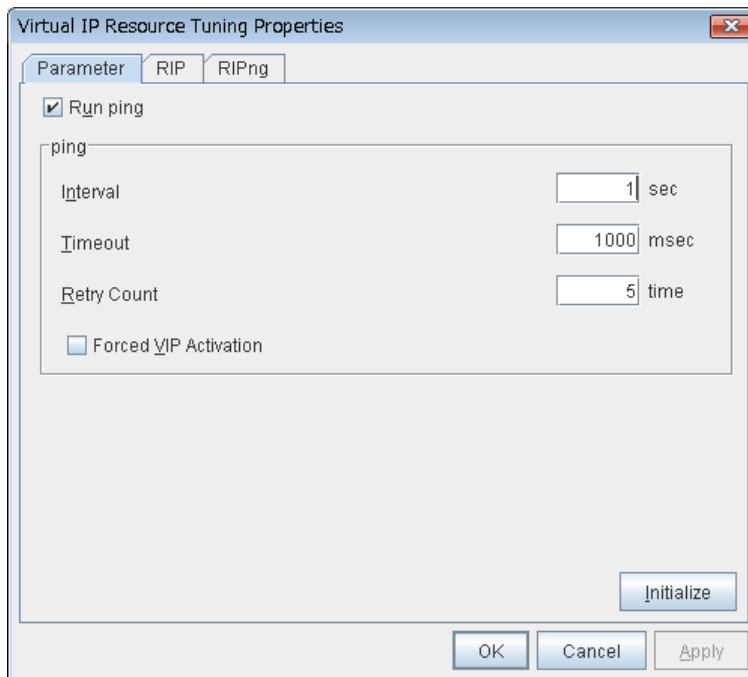

Run ping

Use this button to configure whether or not to check if there is any overlapped IP address by the ping command before activating the virtual IP resource.

- When the checkbox is selected:
Check by using the ping command.
- When the checkbox is not selected:
Do not check by using the ping command.

ping

In this box, make detailed settings of the ping command used to check for any overlapped IP address before activating the virtual IP resource.

- **Interval (0 to 999)**
Specify the interval to issue the ping command in seconds.
- **Timeout (1 to 999999)**
Specify the timeout for the ping command in milliseconds.
- **Retry Count (0 to 999)**
Specify how many retries of issuing the ping command are attempted.
- **Forced VIP Activation**
Use this button to configure whether to forcibly activate the virtual IP address when an overlapped IP address is found using the ping command.
- **When the checkbox is selected:**
Forcefully activate the virtual IP address.
- **When the checkbox is not selected:**
Do not forcefully activate the virtual IP address.

NIC Link Down is treated as error

Specify whether to check for an NIC Link Down before the floating IP resource is activated.

- **When the checkbox is selected:**
In the case of an NIC Link Down, the floating IP resource is not activated.
- **When the checkbox is not selected:**
Even in the case of an NIC Link Down, the floating IP resource is activated. This operation is the same as before.

Initialize

Clicking **Initialize** sets the values of all the items to the defaults.

RIP tab

Detailed settings on RIP of virtual IP resource are displayed.

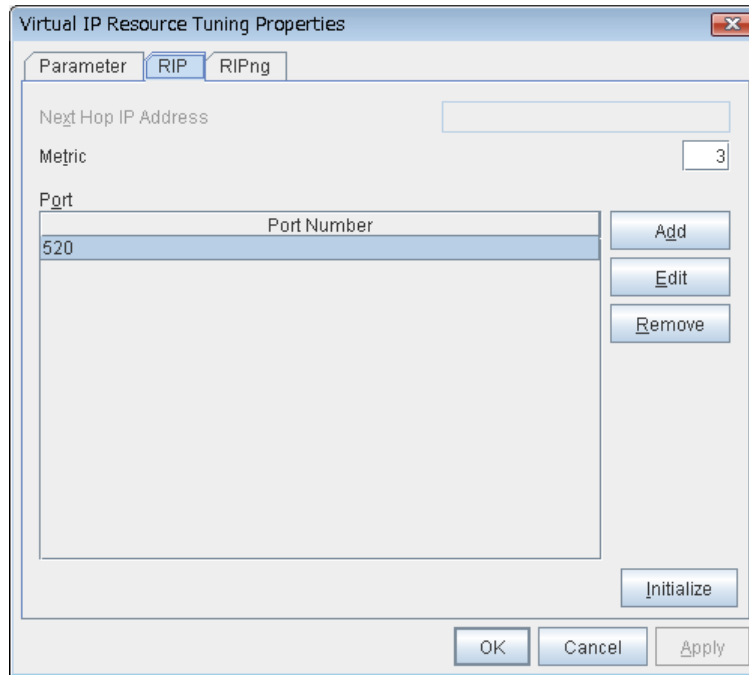

Next Hop IP Address **GroupStopRestart**

Enter the next hop address (address of the next router). Next hop IP address can be omitted. It can be specified for RIPver2 only. You cannot specify a netmask or prefix.

Metric (1 to 15) **GroupStopRestart**

Enter a metric value of RIP. A metric is a hop count to reach the destination address.

Port **GroupStopRestart**

On **Port Number**, a list of communication ports used for sending RIP is displayed.

Add

Add a port number used for sending RIP. Click this button to display the dialog box to enter a port number.

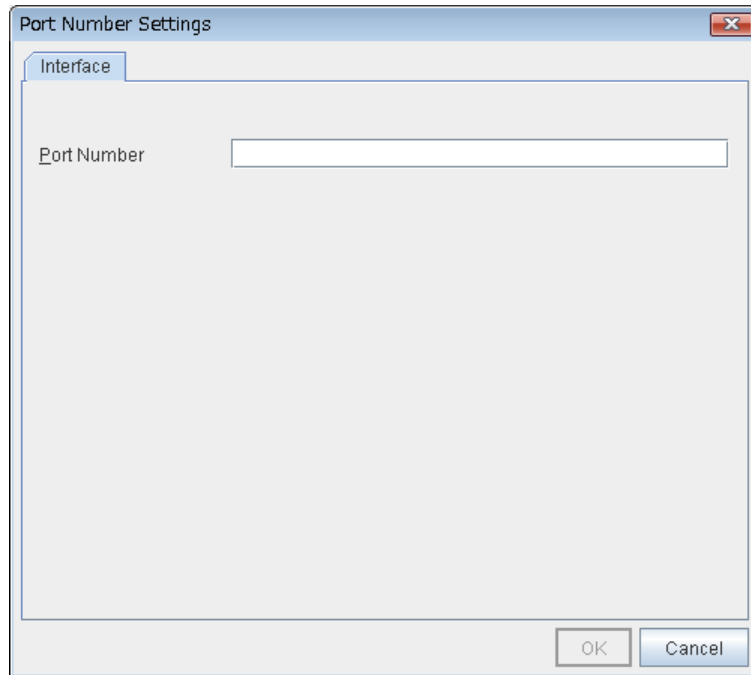
**Port Number**

Enter a port number to be used for sending RIP, and click **OK**.

Remove

Click **Remove** to delete the selected port on the **Port Number**.

Edit

A dialog box to enter a port number is displayed. The port selected in the **Port Number** is displayed. Edit it and click **OK**.

Initialize

Clicking **Initialize** sets the values of all the items to the defaults.

RIPng tab

Detailed settings of RIPng of virtual IP resource are displayed.

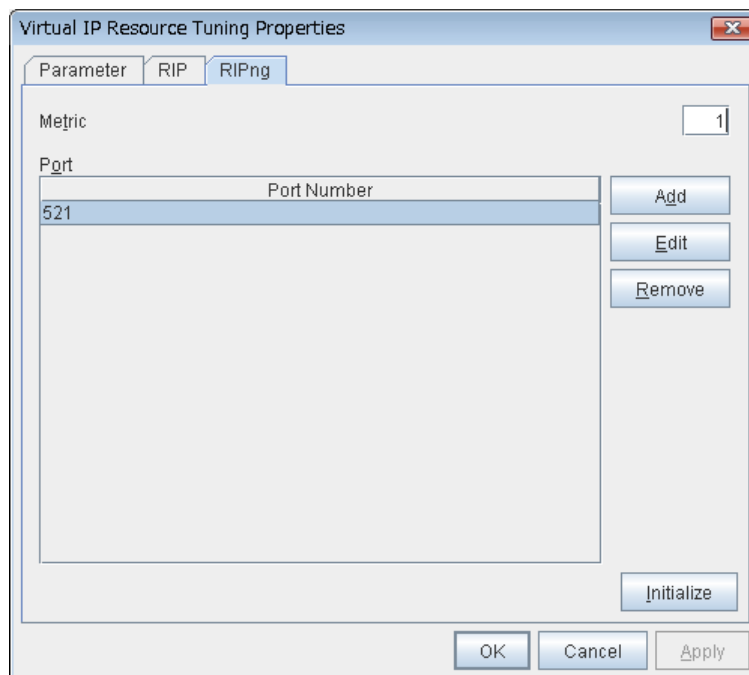

Metric (1 to 15) **GroupStopRestart**

Enter a metric value of RIPng. A metric is a hop count of RIPng to reach the destination address.

Port **GroupStopRestart**

On **Port Number**, a list of ports used for sending RIPng is displayed.

Initialize

Clicking **Initialize** sets the values of all the items to the defaults.

Add

Add a port number used for sending RIPng. Click this button to display the dialog box to enter a port number.

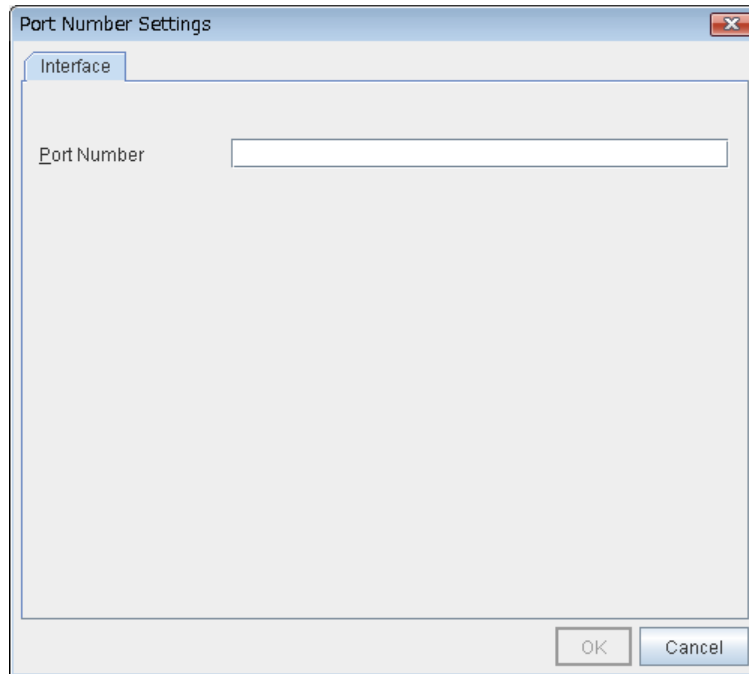
**Port Number**

Enter a port number to be used for sending RIPng, and click **OK**.

Remove

Click **Remove** to delete the selected port on the **Port Number**.

Edit

A dialog box to enter a port number is displayed. The port selected in the **Port Number** is displayed. Edit it and click **OK**.

Displaying the virtual IP resource properties with the WebManager

1. Start the WebManager (*http:// Management IP address or the IP address of the cluster server: port_number* (the default value is 29003)).
2. Click an object for virtual IP resource  in the tree view. The following information is displayed in the list view.

Virtual IP Name: vip1		Details
Common server1 server2		
Properties	Value	
Comment		
IP Address	192.168.0.1	
Subnet Mask	255.255.255.0	
Destination IP Address	192.168.17.255	
Source IP Address	192.168.17.1	
Send Interval	30	
Routing Protocol	RIPver1	
Status	Online	
Started Server	server1	

Comment:	Comment for the virtual IP resource
IP Address:	IP address of the virtual IP resource
Subnet Mask:	Subnet mask of the virtual IP resource
Destination IP Address:	Destination IP Address of RIP for virtual IP resource
Source IP Address:	Source IP Address of RIP for virtual IP resource
Send Interval:	Interval of RIP sending for virtual IP resource
Routing Protocol:	RIP version for virtual IP resource
Status:	Status of the virtual IP resource
Started Server:	The server which the resource has started

If you click **Details**, the following information is displayed in the pop-up dialog.

Properties	Value
Name	vip1
Type	vip
Failover Target Server	Stable Server
Failover Threshold	Number of Servers
Retry Count at Activation Failure	5
Final Action at Activation Failure	No operation (not activate next resource)
Execute Script before Final Action	Off
Retry Count at Deactivation Failure	0
Final Action at Deactivation Failure	No operation (not deactivate next resource)
Execute Script before Final Action	Off
Dependent Resources	
Retry Interval at Activation Failure	5
Retry Interval at Inactivation Failure	5
Ping Execute	On
Ping Timeout (milliseconds)	1000
Ping Retry Threshold	5
Ping Retry Interval (seconds)	1
VIP Force Activation	Off
RIP Next Hop IP Address	
RIP Metric	3
RIP Port Number	520
RIPng Metric	1
RIPng Port Number	521

Name:	Virtual IP resource name
Type:	Resource type
Failover Target Server:	Determination method of Failover Target Server
Failover Threshold:	The number of failovers to be made at detection of an error
Retry Count at Activation Failure:	The number of times activation is retried when an activation error is detected
Final Action at Activation Failure:	Final action at an activation error
Execute Script before Final Action:	Whether or not script is executed upon activation failure
Retry Count at Deactivation Failure:	The number of times deactivation is retried when a deactivation error is detected
Final Action at Deactivation Failure:	Final action when a deactivation error is detected
Execute Script before Final Action:	Whether or not script is executed upon deactivation failure
Dependent Resources:	Dependent resources
Retry Interval at Activation Failure:	Activation retry interval
Retry Interval at Inactivation Failure:	Deactivation retry interval
Ping Execute:	Issue the ping command to verify overlapped IP address
Ping Timeout (milliseconds):	Timeout for the ping command (millisecond)
Ping Retry Threshold:	Threshold value for retrying the ping command
Ping Retry Interval (seconds):	Retry interval for the ping command
VIP Force Activation:	Forcibly activate the virtual IP resource
RIP Next Hop IP Address:	Next hop address of RIP
RIP Metric:	RIP metric
RIP Port Number:	RIP port number
RIPng Metric:	RIPng metric
RIPng Port Number:	RIPng port number

Understanding CIFS resources

Dependencies of CIFS resources

By default, CIFS resources depend on the following group resources type:

Group resource type
Disk resource
Mirror disk resource
Hybrid disk resource

CIFS resources

CIFS resources control publicizing and removal of shared folders. By using CIFS resources, the folders on shared disks and mirror disks are publicized as a shared file.

There are two ways of publicizing as follows:

Specify shared configuration individually

Specify shared folder configuration in advance in configuration items of CIFS resources, and then publicize shared folder with the configuration specified at resource activation. You need to create CIFS resource per shared folder to be publicized.

Auto-save shared configuration of drive

When a specified folder on shared disk/mirror disk is shared and publicized, acquire the shared configuration and save it in the configuration file of shared disk/mirror disk. The shared configuration is once released when shared disk/mirror disk is deactivated, but the shared folder is publicized again with the saved configuration.

This section describes the operation when you have checked the [**Auto-save shared configuration of drive**].

CIFS resources will automatically get the information of the shared folder on the drive, and then save it to the [**Shared Configuration File**]. Because it does not exist shared settings file during the initial start-up of CIFS resources, it scans all of the shared folder information on the drive, and then save it to the [**Shared Configuration File**].

Then you can update the shared settings file from the CIFS resources each time the set of shared folder is changed.

When CIFS resources becomes deactivation I will remove all share. However, since the rest is shared information in the [**Shared Configuration File**], and then automatically recover the shared information at the time of activity.

The following table shows the advantage and disadvantage of the two methods.

	Advantage	Disadvantage
Specify shared configuration individually	Inconsistency does not occur in the shared configuration.	When the shared configuration is changed, it is necessary to change the CIFS resource.
Auto-save shared configuration of drive	Changes made for the shared configuration are automatically saved.	When the shared configuration file is corrupted, inconsistency occurs in the shared information.

Notes on CIFS resources

- When files on the shared disks or the mirror disks are publicized, the sharing settings, which are configured by right-click, will be cleared by deactivation of disk resource or mirror disk resource, which will result in no inheritance to another server at a failover. In this case, publicize and delete the shared folders by using the ARMNSADD and ARMNSDEL commands from scrip resource, or use CIFS resources.
- When shared configuration of drive is automatically saved, shared configuration file configured as the saving destination is created as a hidden file. For the back up when the shared configuration file is corrupted, a file with ".bak" at the end of the specified file name is created in the same folder. Ensure not to use the same file name with the currently existing file.
- A folder that the shared configuration file is to be created must have access permission to create/update a file for the local system account (SYSTEM). Without proper access permission, creation/updating of the shared configuration file fails. If both the shared configuration file and the backup file are deleted mistakenly, configuration data may be lost. It is recommended that these files should not be deleted by other account.
- If any of the conditions mentioned below arises when publicizing and removal of shared folders on the shared disk is controlled with CIFS resources, the activation of CIFS resources fails. Perform troubleshooting procedure 1 or 2. When the internal version of EXPRESSCLUSTER is 11.21 or later, troubleshooting procedure 1 is recommended.

<Conditions>

- In Windows Server 2012 or later, the failback of the CIFS resources is executed after the server is restarted for a reason other than cluster shutdown and reboot.
- CIFS resources are activated for the first time after a deactivation error.
- In Windows Server 2012 or later, a shared disk or mirror disk cluster is configured and folders on the shared disk or mirror disk are controlled with CIFS resources.

<Troubleshooting procedure 1>

Select the **When folder is shared not as activity failure** check box.

<Troubleshooting procedure 2>

It is necessary to delete the shared name by using a script resource before activating CIFS resources. Add a script resource and change the settings, as follows.

1. Add a script resource, and open **Properties**. In the **Dependency** tab, clear **Follow the default dependence**, and add the corresponding disk resource to **Dependent Resources**.
2. Open the **Details** tab of the script resource added in 1, and add the following lines of code (*) to start.bat.

```
:NORMAL
net share <CIFS_resource_controlled_shared_name>
/delete (*Add)
(Omitted)
:FAILOVER
net share <CIFS_resource_controlled_shared_name>
/delete (*Add)
```

To use **Auto-save shared configuration of drive** for CIFS resources, it is necessary to add all the shared names controlled with CIFS resources.
3. Open **Properties** of CIFS resources. In the **Dependency** tab, clear **Follow the default dependence**, and add the corresponding disk resource and the script resource added in 1 to **Dependent Resources**.

- Sharing access Please set a reference that can be user/groups from all cluster nodes. It does not set NTFS Permissions in CIFS resource
- When migrating the Active Directory server, if you configure the accounts of the migration source and destination server domains to share a shared folder with the SID history function enabled, the share setting for the accounts of the source server cannot be maintained.
- If the access permissions applied to the shared folder are either of the following, activating a CIFS resource fails. Apply the proper access permissions.
 - Among the SYSTEM access permissions, the **Read** permission is denied.
 - Among the SYSTEM access permissions, the **List of Folder Contents** permission is denied.
- When **When folder is shared not as activity failure** is enabled (selected), activating the CIFS resource fails if a user saved in the Shared Configuration File is deleted. To delete a user who is set in Permissions for the shared folder, perform either of the following:
 - Disable (clear) **When folder is shared not as activity failure**.
 - To delete a use who is set in Permissions for the shared folder, also delete the corresponding group from **Advanced Sharing > Permissions** on the **Sharing** tab of the properties of the shared folder on the drive set to the CIFS resource.
- If the Shared Configuration File is damaged, recover it by performing either of the following:
 - Among the SYSTEM access permissions, the **Read** permission is denied. Stop the CIFS resource and replace the damaged file with the backed up Shared Configuration File. Then, start the CIFS resource. This method is effective when there are many folders or there are many sharing settings required to change.
 - Stop the CIFS resource and delete the damaged Shared Configuration File. Then, start the CIFS resource and make the sharing settings again from Explorer.
- If a failover occurred, the shared folder disappears temporarily. This might disable to browse the file open before the failover occurrence or to browse files from Explorer. Therefore, it is recommended to use the shared folder offline as follows:
 - When **Execute the automatic saving of shared configuration of drive** is enabled (selected), select **All files and programs that users open from the share are automatically available offline** for the **Cache** settings of the shared folder.
 - When **Execute the automatic saving of shared configuration of drive** is disabled (not selected), select **Automatic Caching** on the **Cache** tab of the CIFS resource tuning properties.

Displaying and changing the details of CIFS resources

From the tree view displayed on the left pane of the Builder, click the icon of the group to which the CIFS resource whose detailed information and settings you want to display and/or change belongs.

1. The group resources list is displayed on the table view in the right of the window.
2. Right-click the desired CIFS resource name, and click **Properties**. In the properties dialog box, click the **Details** tab.
3. Display and/or change the detailed settings on the **Details** tab as shown below.

CIFS resource Details tab

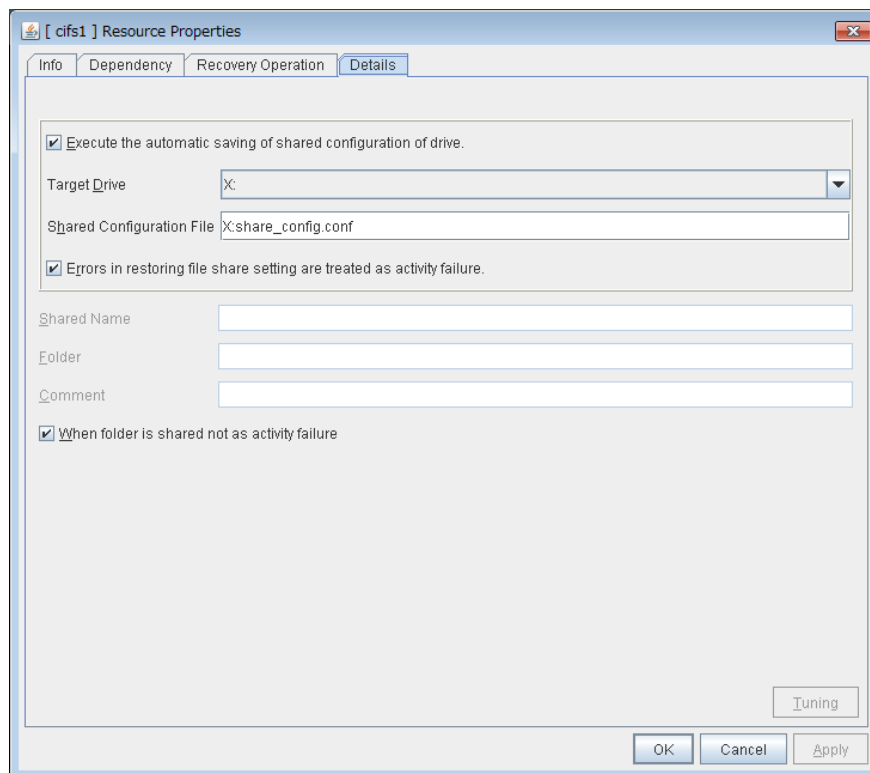

Execute the automatic saving of shared configuration of drive **GroupStopRestart**

Configure whether to save shared configuration of drive automatically. Check this when you want to set the auto-saving.

Target Drive **GroupStopRestart**

Specify the drive letter of the target disk when you want to execute auto saving of shared configuration of drive.

Shared Configuration File (within 225 bytes) **GroupStopRestart**

Specify the file that saves shared configuration of drive with full path. You need to specify a path of shard disk/mirror disk/hybrid disk within the same group.

This is the file that CIFS resource creates. There is no need for you to prepare before CIFS resource activation.

Errors in restoring file share setting are treated as activity failure **GroupStopRestart**

When this option is selected (default): Activating CIFS resources fails in cases where users saved in shared configuration file does not exist or user information cannot be obtained from domain environment. When the shared folder configuration is changed, if no user is set in **Permissions** for the shared folder or if user information cannot be obtained from the domain environment, a warning message appears.

When this option is not selected: Activating CIFS resources is successful in above cases. The file sharing access permission is not granted to a user whose information could not be acquired. The warning message does not appear.

The following configurations are executed when specifying shared configuration individually.

Shared name (within 80 bytes) **GroupStopRestart**

Specify the name of the shared folder, which is publicized by using CIFS resource. The following can not be used.

:

Folder (within 255 bytes) **GroupStopRestart**

Specify the full path to the shared folder, which is publicized by CIFS resources.

Comment (within 256 bytes) **GroupStopRestart**

Specify the comment of the shared folder, which is publicized by using CIFS resource.

When folder is shared not as activity failure **GroupStopRestart**

When this option is not selected: The activation of CIFS resources fails when folders are already shared. In Windows Server 2012 or later, this condition always arises because of the change in the OS specifications. It is therefore recommended to check this option.

When this option is selected (default): The activation of CIFS resources succeeds in the above case. The warning message is not output.

Tuning

Display CIFS resource tuning properties dialog box. You can change the settings of the detail information of the CIFS resource.

CIFS resource tuning properties

Cache tab

Display the details of cache

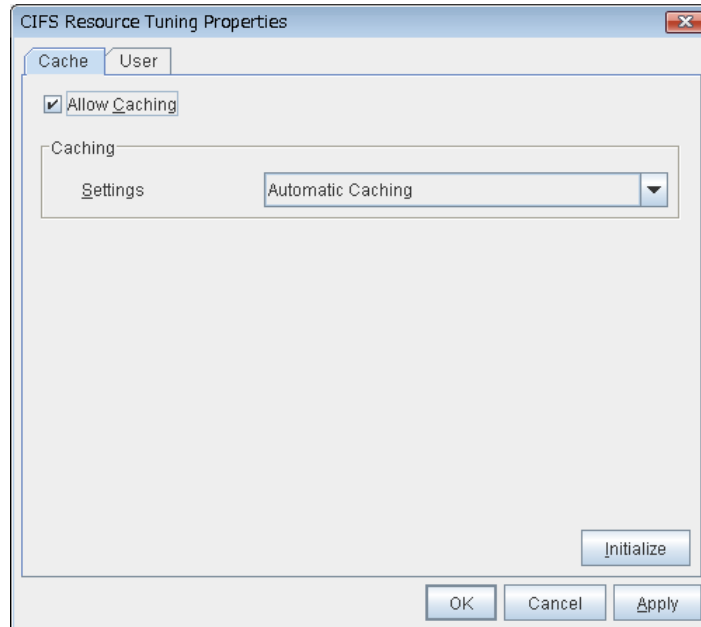

Allow Caching **GroupStopRestart**

Set to enable the caching of shared folders. By enabling this function, the files in the shared folders can be referenced in the offline status when specifying shared configuration individually, and those files can still be referenced after a failover. This function is not used when **Auto-save shared configuration of drive** method is selected.

Settings **GroupStopRestart**

Select the caching settings if you choose to allow caching.

Choose one of the following settings. Manual Caching (**Enable BranchCache**) that is added for Windows Server 2008 R2 or later is not supported.

- Automatic Caching
This setting is equivalent to the following setting in the Windows OS. The message corresponding to this setting may be different depending on the version of Windows.
All files and programs that users open from the share will be automatically available offline.
- Manual Caching
This setting is equivalent to the following setting in the Windows OS. The message corresponding to this setting may be different depending on the version of Windows.
Only the files and programs that users specify will be available offline.
- Automatic Caching (Optimized for the performance)
This setting is equivalent to the following setting in the Windows OS. The message corresponding to this setting may be different depending on the version of Windows.
Optimize for performance

Initialize

Click **Initialize** to initialize all the items to the default value.

User tab

Display the detailed settings of restriction of the number of users and permission of access.

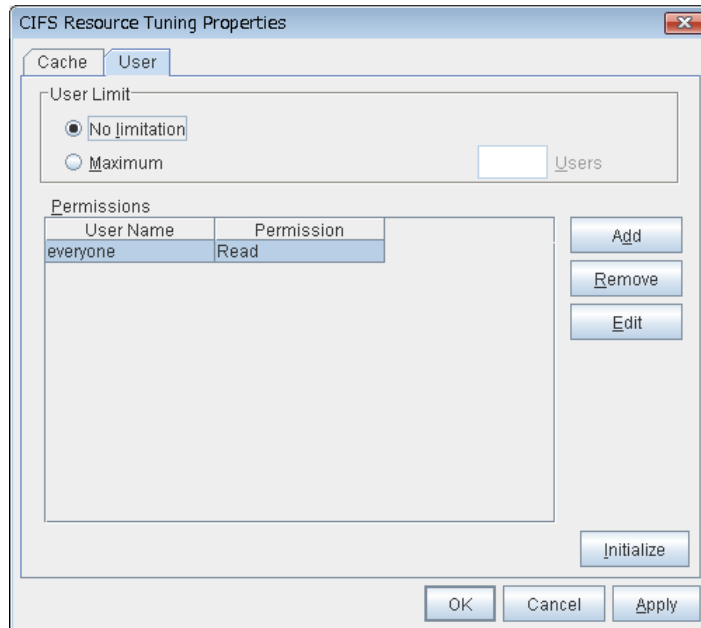

User Limit (1 to 9999) **GroupStopRestart**

Set the maximum number of users who can access the shared folder at a time.

Add **GroupStopRestart**

Add the settings of access permission for user account or user group to **Access Permission**. When you click this button, the **Enter user** dialog box is displayed. Specify the user name and the permission.

Remove **GroupStopRestart**

Delete the access permission selected in **Permissions**.

Edit **GroupStopRestart**

Modify the access permission specified in **Permissions**. The **Enter user** dialog box is displayed. The specified access permission displayed in the **Enter user** allows you to modify permission.

Initialize

Click **Initialize** to initialize all the items to the default values.

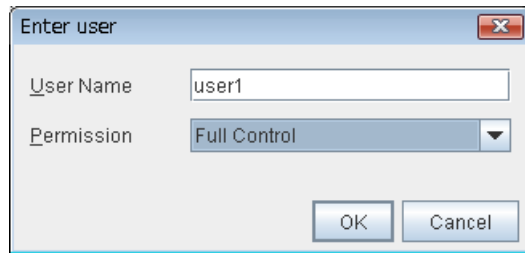

User Name (Within 256 bytes)

Enter the Windows user name or a group name. When using a domain account, enter in the format of “*Domain_name\User_name*”. No two-byte characters can be registered for **User Name**. A name containing a one-byte space can be registered. (Example: Domain Admins). If you want to use the double-byte characters in the Windows user name or group name, please check the [Auto-save shared configuration of drive].

Permission

Select one of following settings for access permission of the entered user/group.

- Full control
- Change
- Read
- None

When **None** is selected, access is denied.

Displaying CIFS resource properties with the WebManager

1. Start the WebManager (*http://Management IP address or the IP address of the cluster server:port_number* (Default value is 29003)).
2. Click the object for CIFS resource  in the tree view. The following information is displayed in the list view.

CIFS: cifs1	
Details	
Common server1 server2	
Properties	Value
Comment	
Share Name	
Path	
Drive Administration	On
Drive	X:
Config File Path	X:share_config.conf
Error Check for Restoring Config File	On
Ignoring Duplicated Share Name	On
Status	Online
Started Server	server1

- | | |
|-----------------------|---|
| Comment: | CIFS resource comment |
| Share Name: | Name of the shared folder publicized by CIFS resource |
| Path: | Path to the shared folder publicized by CIFS resource |
| Drive Administration: | Execute auto-saving of shared configuration |
| Drive: | Target drive to execute auto-saving of shared configuration |

Config File paths: File path to save share configuration
 File share setting restoration error check: Errors in restoring file share setting are treated as activity failure
 Do not treat shared file name overlap as error: Do not treat as activation failure when folders are already shared
 Status: Status of CIFS resource
 Started Server: The server which the resource has started

If you click **Details**, the following information is displayed in the pop-up dialogue.

Properties	Value
Name	cifs1
Type	cifs
Failover Target Server	Stable Server
Failover Threshold	Number of Servers
Retry Count at Activation Failure	0
Final Action at Activation Failure	No operation (not activate next resource)
Execute Script before Final Action	Off
Retry Count at Deactivation Failure	0
Final Action at Deactivation Failure	Stop the cluster service and shutdown OS
Execute Script before Final Action	Off
Dependent Resources	md1
Retry Interval at Activation Failure	5
Retry Interval at Inactivation Failure	5
Comment	
User Limit	Maximum Allowed
Client-side Cache	Off
CSC Method	Automatic Caching

Name: CIFS resource name
 Type: Resource type
 Failover Target Server: Determination method of Failover Target Server
 Failover Threshold: The number of failovers to be made at detection of an error
 Retry Count at Activation Failure: The number of times activation is retried when an activation error is detected
 Final Action at Activation Failure: Final action at an activation error
 Execute Script before Final Action: Whether or not script is executed upon activation failure
 Retry Count at Deactivation Failure: The number of times deactivation is retried when a deactivation error is detected
 Final Action at Deactivation Failure: Final action when a deactivation error is detected
 Execute Script before Final Action: Whether script is executed upon deactivation failure
 Dependent Resources: Dependent resources
 Retry Interval at Activation Failure: Activation retry interval
 Retry Interval at Inactivation Failure: Deactivation retry interval
 Comment: Comment of the shared folder publicized by CIFS resource
 User Limit: Maximum number of users that can simultaneously connect to the shared folder publicized by CIFS resource
 Client -side Cache: Whether or not to cache of the shared folder publicized by CIFS resource
 CSC Method: Cache method of the shared folder publicized in CIFS resource

Understanding NAS resources

Dependencies of NAS resources

By default, NAS resources depend on the following group resources types:

Group resource type
Floating IP resource
Virtual IP resource
AWS elastic ip resource
AWS virtual ip resource
Azure probe port resource

NAS resources

NAS resources control mounts / unmounts of a network drive. By storing data required for business operation on the network drive mounted by NAS resources, the data is taken over to the other servers in the case of failover or transfer of fail groups.

Notes on NAS resources

- NAS resources mount a network drive by local system account. Because applications and scripts activated by the application resources or script resources are executed in the local system unless otherwise specified, they can access this network drive. However applications with no permission to access the shared folder mounted as the network drive cannot access the network drive mounted by NAS resources.
- When multiple NAS resources mount the shared folders on the same file server, the same name should be configured as the account to access the file server.
- For the applications (databases) for which orders for the orders to disks and completion of writing should be assured the network drive may not be used as storage for data files.
- The network drive mounted by NAS resource is displayed as **Disconnected Network Drive** in **My computer** on explorer. The connection account information configured by NAS resources is not taken over to the logon session except local system account. When the login account has no right to the target shared folders, you cannot access this network drive from explorer unless you explicitly specify the connecting account to the server that has the shared folders.

Displaying and changing NAS resources

1. From the tree view displayed on the table view in the right of the window. Click the icon of the group to which the NAS resources whose detailed information and settings you want to display and/ or change belong.
2. The group resources list is displayed on the table view in the right of the window. Right-click the desired NAS resource name, and click **Properties**. In the properties dialog box, click the **Details** tab.
3. Display and/or change the detailed settings on the **Details** tab as shown below.

NAS resource details tab

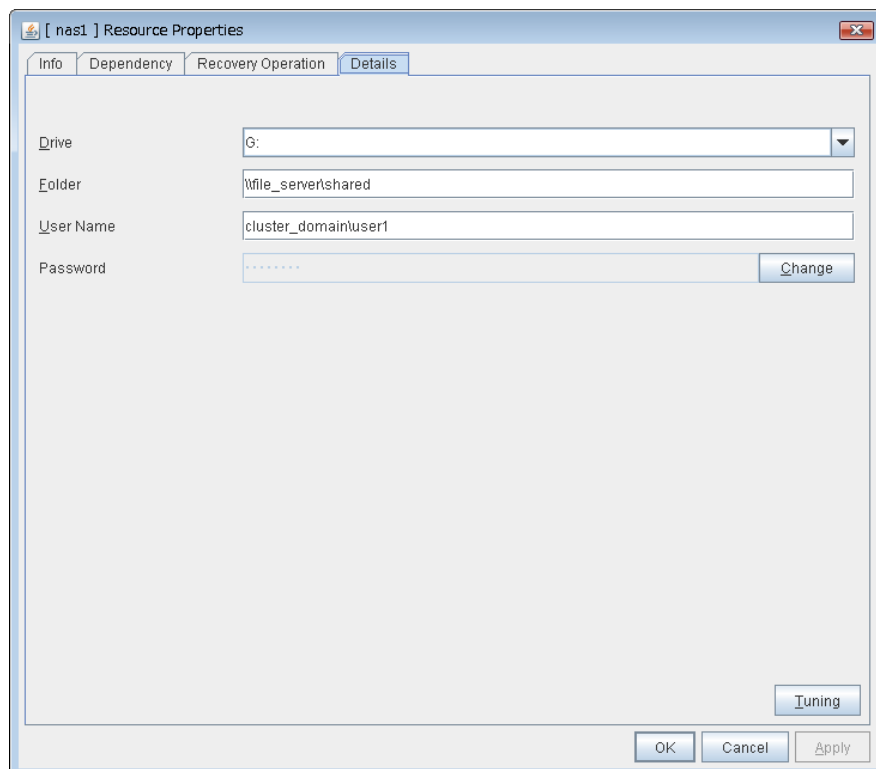

Drive **GroupStopRestart**

Specify the drive letter of the network to be mounted by NAS resource.

Folder (Within 259 bytes) **GroupStopRestart**

Specify the shared folder mounted by NAS resource in the UNC format.

User Name (Within 95 bytes) **GroupStopRestart**

Specify the user name of the account required to mount shared folders by NAS resources. No two-byte characters can be registered for **User Name**. A name containing a one-byte space can be registered. (Example: Domain Admins).

Enter it as a file_server_name\user_name or a domain_name\user_name. (Example: SERVER1\user)

Password (Within 40 bytes) **GroupStopRestart**

Specify the account password required to mount shared folders by NAS resource.

Tuning

Display the **NAS Resource Tuning Properties** dialog to set the details of NAS resource.

NAS resource tuning properties

Disconnect

Display the details about mounting of network drive.

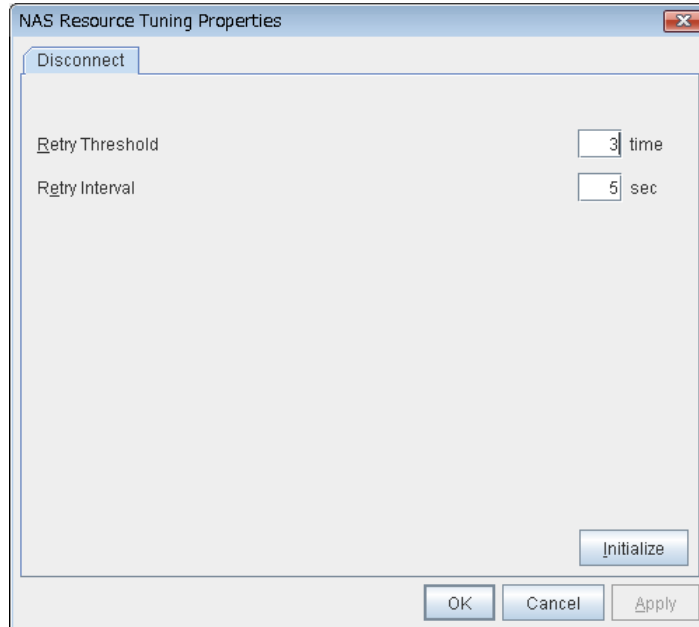

Retry Threshold (0 to 999) **GroupStopRestart**

Specify the number of times to retry when failed to unmount.

Retry Interval (0 to 999) **GroupStopRestart**

Specify the retry intervals when failed to unmount.

Initialize

Click **Initialize** to initialize all the items to the default values.

Displaying NAS resource properties with the WebManager

1. Start the WebManager (http://Management IP address or the IP address of the cluster server:port_number (Default value is 29003)).
2. Click the object for NAS resource,  in the tree view. the following information is displayed in the list view.

NAS Name: nas1		Details	
Common		server1	server2
Properties	Value		
Comment			
Drive	Z:		
Network Resouse	\c\lg200\nas_test		
Status	Online		
Started Server	server1		

Comment:

Comment of NAS resource

Drive:

Drive letters for network drive mounted by NAS resource

Network Resource: Shared folders mounted by NAS resource
 Status: Status of NAS resource
 Started Server: The server which the resource has started

If you click **Details**, the following information is displayed in the pop-up dialogue.

Properties	Value
Name	nas1
Type	nas
Failover Target Server	Stable Server
Failover Threshold	Number of Servers
Retry Count at Activation Failure	0
Final Action at Activation Failure	No operation (not activate next resource)
Execute Script before Final Action	Off
Retry Count at Deactivation Failure	0
Final Action at Deactivation Failure	No operation (not deactivate next resource)
Execute Script before Final Action	Off
Dependent Resources	fip1,vip1
Retry Interval at Activation Failure	5
Retry Interval at Inactivation Failure	5
User Name	clg200\administrator
Disconnect Retry Threshold	3
Disconnect Retry Interval (seconds)	5

Name: NAS resource name
 Type: Resource type
 Failover Target Server: Determination method of failover server
 Failover Threshold: The number of failovers to be made at detection of an error
 Retry Count at Activation Failure: The number of times activation is retried when an activation error is detected
 Final Action at Activation Failure: Final action at an activation error
 Execute Script before Final Action: Whether or not script is executed upon activation failure
 Retry Count at Deactivation Failure: The number of times deactivation is retried when a deactivation error is detected
 Final Action at Deactivation Failure: Final action when a deactivation error is detected
 Execute Script before Final Action: Whether or not script is executed upon deactivation failure
 Dependent Resources: Dependent resources
 Retry Interval at Activation Failure: Activation retry interval
 Retry Interval at Inactivation Failure: Deactivation retry interval
 User name: Account user name to mount shared folders in NAS resource
 Disconnect Retry Threshold: The number of retries to be performed when unmounting fails
 Disconnect Retry Interval (seconds): Interval between retries that are performed when unmounting fails (seconds)

Understanding hybrid disk resources

Dependencies of hybrid disk resources

By default, hybrid disk resources do not depend on any group resource type.

Hybrid disk

A hybrid disk resource is a resource in which disk resource and mirror disk resource are combined. When you use a disk resource, a failover group can perform failover only to the cluster server connected to the same shared disk. On the other hand, in hybrid disk, by mirroring the data in the shared disk, failover can be performed to a server which is not connected to the shared disk. This enables configuring a remote cluster as in the following figure, where failover is performed in the active site upon normal failure, while failover can be performed to the stand-by site when a disaster occurs.

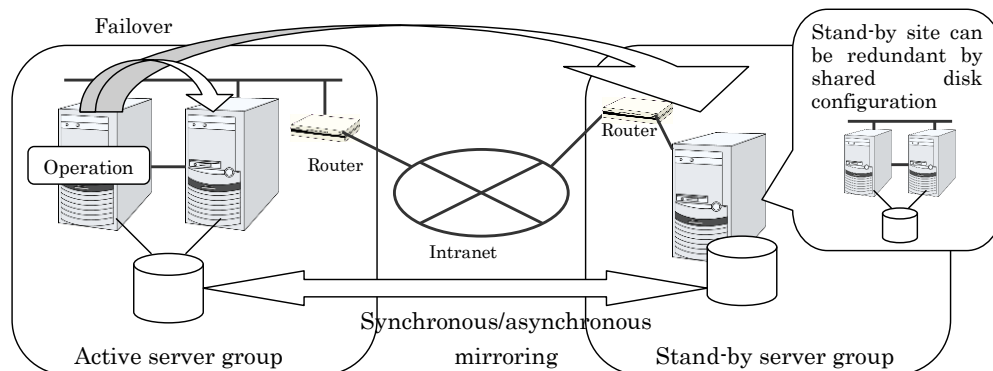

In hybrid disk, a group of servers that is connected to the shared disk is referred to as a server group. Disk mirroring is performed between two server groups. A server which does not use the shared disk is a server group in which there is only one server.

Like mirror disk resources, mirroring takes place in each partition, where RAW partition (cluster partition) to record management information is required as well as data partition which is the mirroring target. It is necessary that each server using hybrid disk resource has a license for EXPRESSCLUSTER X Replicator DR 3.3 for Windows.

Notes on hybrid disk resources

- **Data partition size**

The sizes of data partitions to be mirrored need to be exactly the same by byte.

If the type or geometry of the disks differs, you may fail to configure the same size for partitions. If this happens, check the precise size of data partitions of the servers by the `clpvolsz` command before configuring hybrid disk resource. If the sizes are not consistent, run the `clpvolsz` command again to contract the larger partition.

For details on the `clpvolsz` command, see “Tuning partition size (`clpvolsz` command) in Chapter 3, “EXPRESSCLUSTER command reference” in this guide.

There is no limit for data partition size.
- **Time required for data partition copying**

When a file is copied at initial configuration or disk replacement, the required amount of time increases in proportion to the size of the volume use area. If the volume use area cannot be specified, the required amount of time increases in proportion to the data partition size because the entire area of the volume is copied.
- **Cluster partition size**

Reserve at least 17MB. In some disk geometry it may be 17MB or larger, which is not a problem.
- **Partition drive letter**

Specify the same drive letters in each server for data partition and cluster partition.

Do not change the drive letter until deleting resources after configuring hybrid disk resources. If a drive letter has been changed, restore the drive letter when hybrid disk resource is started. When the original drive letter is used by other partition, starting mirror disk resource fails.
- **Partition allocation**

When a data partition on the shared disk is mirrored, the data partition and the cluster partition need to be allocated on the same shared disk (they do not have to be allocated on the same logical disk).

Allocate the data partition and the cluster partition on a basic disk. Dynamic disk is not supported.

When making data partitions as logical partitions on the extended partition, make sure the data partitions are logical partition on both servers. The actual size may be slightly different even the same size is specified on both basic partition and logical partition.
- **Partition format**

Format a data partition by NTFS. FAT/FAT32 is not supported.

It is not necessary to construct a file system in a cluster partition. Do not format it.
- **Access control of a data partition**

The data partition to be mirrored by a hybrid disk resource can be accessed only from the active server where a hybrid disk resource is activated. Access from other servers is restricted by EXPRESSCLUSTER.

Access to the cluster partition is also restricted by EXPRESSCLUSTER.
- **Partition deletion**

When you delete a data partition or cluster partition on the hybrid disk resource, delete the hybrid disk resource in Builder in advance.
- **Server group settings**

In a failover group having hybrid disk resource, it is necessary to register two server groups which are mirrored by the hybrid disk resource in the **Server Groups** tab of **Group Properties**. Configure the settings for these server groups in **Server Groups** in the tree view in Builder.

- Changing the configuration between the mirror disk and hybrid disk
To change the configuration so that the disk mirrored using a mirror disk resource will be mirrored using a hybrid disk resource, first delete the existing mirror disk resource from the configuration data, and then upload the data. Next, add a hybrid disk resource to the configuration data, and then upload it again.
- Changing the configuration between the mirror disk and hybrid disk
- Disk devices that configure hybrid disks
 - For the data partition and the cluster partition of hybrid disk resources, use disk devices with the same logical sector size on all servers. If you use devices with different logical sector sizes, they do not operate normally. They can operate even if they have different sizes for the data partition and the cluster partition.
- Examples)

Combinationi	Logical sector size of the partition				Description
	Server 1		Server 2		
	Data partition	Cluster partition	Data partition	Cluster partition	
OK	512B	512B	512B	512B	The logical sector sizes are uniform.
OK	4KB	512B	4KB	512B	The data partitions have a uniform size of 4 KB, and the cluster partitions have a uniform size of 512 bytes.
NG	4KB	512B	512B	512B	The logical sector sizes for the data partitions are not uniform.
NG	4KB	4KB	4KB	512B	The logical sector sizes for the cluster partitions are not uniform.

- **Auto Mirror Initial Construction** is set not to be performed
When you use the hybrid disk resource after disabling **Auto Mirror Initial Construction** on the **Mirror Disk** tab in the **Cluster Properties**, change the icon color of the source server group to green by using Mirror Disk Helper before starting hybrid disk resources for the first time.

Displaying and changing the details of hybrid disk resource

1. From the tree view displayed in the left pane of the Builder, click the icon of the group to which the hybrid disk resource whose detailed information display/setting to be changed belongs.
2. The list of group resources is displayed in the table view in the right pane of the screen. Click the desired hybrid disk resource name, and then the **Details** tab in **Properties**.
3. In the **Details** tab, display or change the details settings according to the following description.

Hybrid disk resource details tab

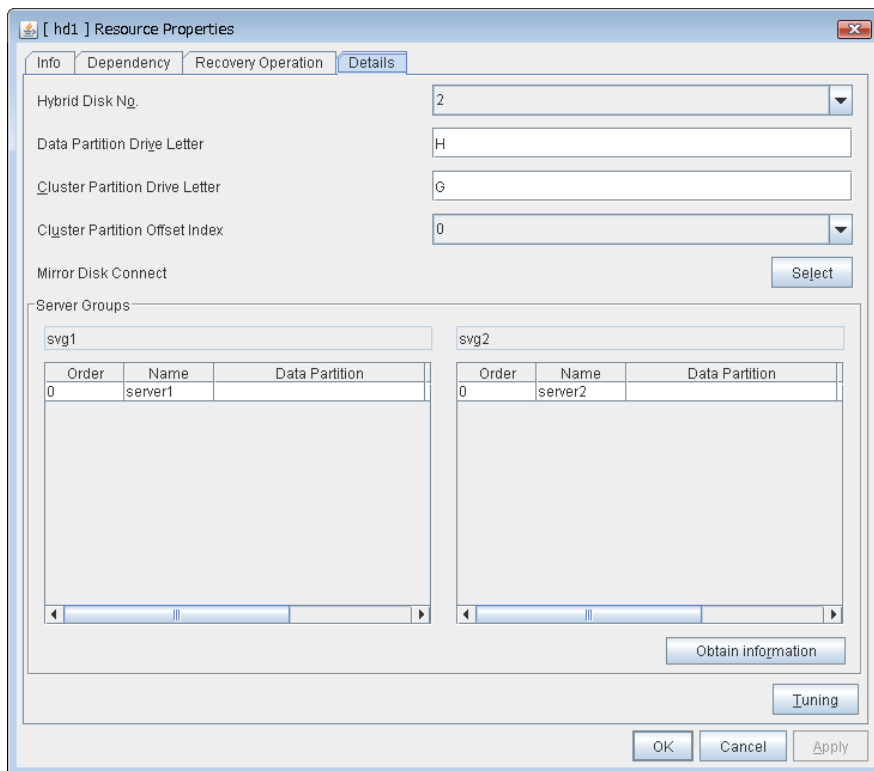

Hybrid Disk No. **SuspendResume GroupStopRestart**

Select a disk number to be allocated to a hybrid disk resource. This number must be different from the ones for other hybrid disk resources and mirror disk resources.

Data Partition Drive Letter (within 1023 bytes) **SuspendResume GroupStopRestart**

Specify the drive letter (A to Z) for the data partition.

Cluster Partition Drive Letter (within 1023 bytes) **SuspendResume GroupStopRestart**

Specify the drive letter (A to Z) for the cluster partition. Multiple hybrid disks can use the same cluster partition, but it cannot be the cluster partition of the mirror disk resource.

Cluster Partition Offset Index SuspendResume GroupStopRestart

Select an index number for the area used in the cluster partition. When using the multiple hybrid disks, assign different numbers for hybrid disk so that the areas to be used in the cluster partition do not overlap.

Select ShutdownReboot

Select the communication path for the data mirroring communication (mirror disk connect). Click **Selection of Mirror Disk Connect** dialog box.

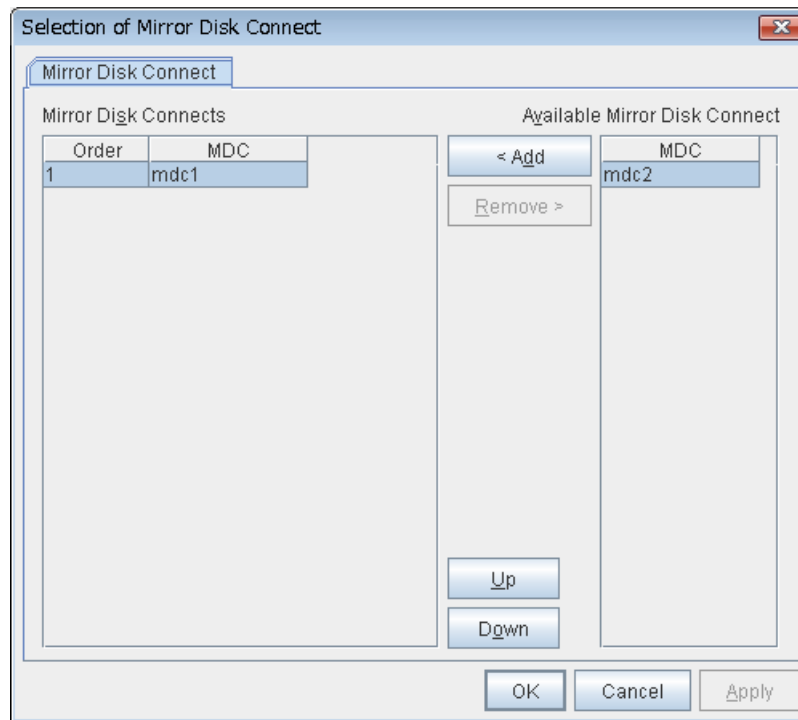

- **Add**
Use **Add** to add mirror disk connects. Select the mirror disk connect you want to add from **Available Mirror Disk Connect** and then click **Add**. The selected mirror disk connect is added to the **Mirror Disk Connects**.
- **Remove**
Use **Remove** to remove mirror disk connects to be used. Select the mirror disk connect you want to remove from the **Mirror Disk Connects** and then click **Remove**. The selected mirror disk connect is added to **Available Mirror Disk Connect**.
- **Up,Down**
Use **Up** and **Down** to change the priority of mirror disk connects to be used. Select the mirror disk connect whose priority you want to change, and then click **Up** or **Down**. The selected row moves accordingly.

For mirror disk connect settings, see “Cluster properties Interconnect tab” in Chapter 2, “Functions of the Builder” in this guide.

Server groups

Information on each member server of the two server groups selected in the **Server Groups** tab in **Properties** of failover groups is displayed.

If Builder is online, clicking **Obtain information** enables you to get GUID information for the data and cluster partitions of each server.

Tuning

The **Hybrid Disk Resource Tuning Properties** dialog box is displayed. You can configure the details on hybrid disk resources.

Tuning hybrid disk resources

In the tree view in the left pane of Builder, click the icon of the group to which the hybrid disk resource you want to display the detailed information or change the settings belongs.

1. The list of group resources is displayed on the table view in the right pane of the screen. Click the desired hybrid disk resource name, and then the **Details** tab in **Properties**.
2. In the **Details** tab, click **Tuning**.
3. The **Hybrid Disk Resource Tuning Properties** is displayed. Display / change the detailed settings according to the following description.

Mirror tab

Detailed settings on mirror are displayed.

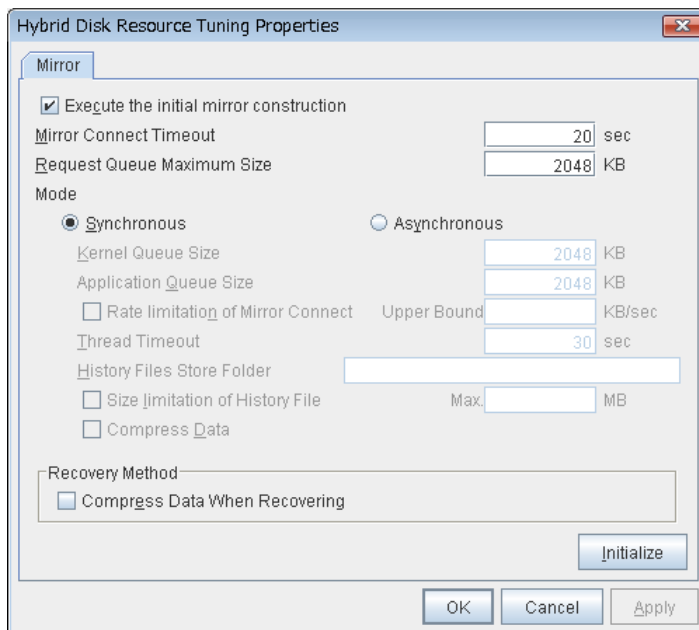

Parameters on this configuration window are the same as those of mirror disk resources.

For the meaning and setting method of each parameter, see “Understanding mirror disk resources” on page 592.

Displaying hybrid disk resource properties with the WebManager

1. Start the WebManager (<http://Management IP address or the IP address of the cluster server:port number> (default value 29003)).
2. Click the object  of hybrid disk resource in the tree view. The following is displayed in the list view:

Hybrid Disk Name: hd1		Details	
Common		server1	server2
Properties	Value		
Comment			
Hybrid Disk No.	2		
Drive Letter	Y		
Mirror Disk Connect	mdc1		
	mdc2		
Status	Offline		
Started Server			

Comment:	Hybrid disk resource comment
Hybrid Disk No.:	Hybrid disk number
Drive Letter:	Drive letters of the data partition
Status:	Status of the hybrid disk resource
Started Server:	The server which the resource has started

Notes on operating hybrid disk resources

If mirror data was synchronized on both server groups when the cluster was shut down, use one of the two orders noted below to start the servers.

- Simultaneously start servers belonging to both server groups at least one at a time
- Start the first server (which belongs to server group 1), and then start the second server (which belongs to server group 2) after the first server has started

Do not consecutively start and shutdown both servers (*).The servers communicate with each other to determine whether the mirror data stored in each server group is up to date. Consecutively starting and shutting down both servers prevents the servers from properly determining whether mirror data is up to date and hybrid disk resources will fail to start the next time both server groups are started.

(*) In other words, do not start and shut down the first server, and then start and shut down the second server.

If you click **Details**, the following is displayed.

Properties	Value
Name	hd1
Type	hd
Failover Target Server	Stable Server
Failover Threshold	Number of Servers
Retry Count at Activation Failure	3
Final Action at Activation Failure	No operation (not activate next resource)
Execute Script before Final Action	Off
Retry Count at Deactivation Failure	0
Final Action at Deactivation Failure	No operation (not deactivate next resource)
Execute Script before Final Action	Off
Dependent Resources	
Retry Interval at Activation Failure	5
Retry Interval at Inactivation Failure	5
Cluster Partition - Drive Letter	X
Cluster Partition - Offset Index	0
Initial Mirror Construction	On
Mode	Synchronous
Max. Number of Request Queues(KB)	2048
Mirror Connect Timeout(sec)	20
Asynchronous - History Files Store Folder	
Asynchronous - Kernel Queue Size (KB)	2048
Asynchronous - Application Queue Size (KB)	2048
Asynchronous - Thread Timeout (sec)	30
Asynchronous - Max. Size of History File(MB)	Unlimited
Asynchronous - Upper Bound of Communication Band...	Unlimited
Compress Data	No

Name:	Hybrid disk resource name
Type:	Resource type
Failover Target Server:	Determination method of Failover Target Server
Failover Threshold:	The number of failovers to be made at detection of an error
Retry Count at Activation Failure:	The number of times activation is retried when an activation error is detected
Final Action at Activation Failure:	Final action at an activation error
Execute Script before Final Action:	Whether or not script is executed upon activation failure
Retry Count at Deactivation Failure:	The number of times deactivation is retried when a deactivation error is detected
Final Action at Deactivation Failure:	Final action at a deactivation error
Execute Script before Final Action:	Whether or not script is executed upon deactivation failure
Dependent Resources:	Dependent resources
Retry Interval at Activation Failure:	Activation retry interval upon activation failure detection
Retry Interval at Inactivation Failure:	Deactivation retry interval upon inactivation failure detection
Cluster Partition:	
Cluster Partition Drive Letter:	Drive letters of the cluster partition
Cluster Partition Offset Index:	Index number for the area to be used for cluster partition
Execute the initial mirror construction:	Whether to execute an initial mirror construction when configuring a cluster
Mode:	Synchronization mode of the mirror data
Max. Number of Request Queues(KB):	Size of queue for the mirror disk drive to queue I/O requests on the communication among servers (KB).

Mirror Connect Timeout (sec):	Time until mirror connect is cut when there is no response on the communication among servers and the data synchronization has not completed at the time of mirror recovery and data synchronization (seconds).
Asynchronous:	
History Files Store Folder:	Folder to keep the writing requests to the remote disk in files
Kernel Queue Size (KB):	Size to keep the writing request to the remote disk in the kernel space memory (KB)
Application Queue Size (KB):	Size to keep the writing request to the remote disk in the user space memory (KB)
Thread Timeout (sec):	Timeout when it became unable to transfer data from the kernel queue to the application queue (seconds)
Max. Size of History File (MB):	Upper limit of amount of files stored in history files store folder (MB).
Upper Bound of Communication Band (KB/sec.):	Upper limit of communication bandwidth used by mirror connect (KB/sec.)
Compress Data:	Whether or not to compress the mirror data flowing through the mirror disk connect

Understanding VM resources

Dependencies of VM resources

By default, this function depends on the following group resource type:

Group resource type

Disk resource

Mirror disk resource

Hybrid disk resource

NAS resource

VM resources

VM resources control virtual machines (guest OSs) from the host OS in the virtualization infrastructure.

VM resources start, stop or migrate virtual machines.

Notes on VM resources

A VM resource can be registered with a group for which the group type is virtual machine.

Only one VM resource can be registered per group.

VM resources are effective when EXPRESSCLUSTER is installed on host OS of virtual infrastructure (Hyper-V).

Displaying and changing the details of VM resources

1. In the tree view displayed in the left pane of the Builder, click the icon of the group to which the VM resource whose details you want to display, specify, or change belong.
2. The list of group resources is displayed on the table view in the right pane of the screen. Right-click the target VM resource name, and then click the **Details** tab in **Property**.
3. On the **Details** tab, display or change the detailed settings according to the following description.

VM resources Details tab

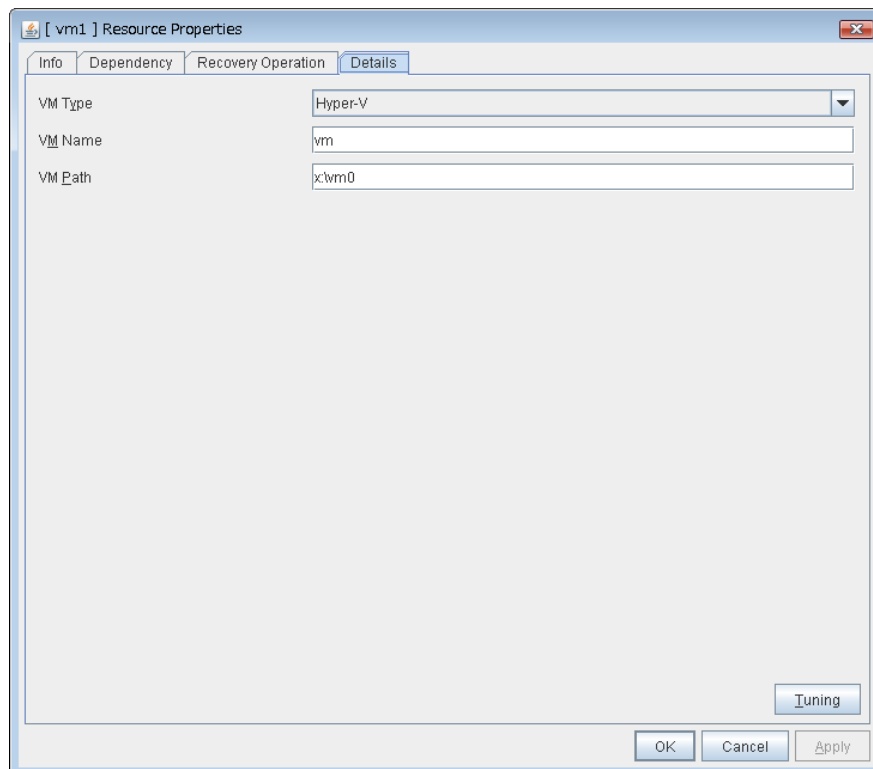

VM Type **GroupStopRestart**

Specify the virtualization infrastructure in which the virtual machine is set up. In this version, Hyper-V is the only option for this.

VM Name **GroupStopRestart**

Enter the virtual machine name displayed in the Hyper-V Manager.

VM Path **GroupStopRestart**

Enter the path of the virtual machine configuration file.

Tuning

This displays the **Virtual Machine Resource Tuning Properties** dialog box. Specify detailed settings for the VM resource.

VM Resource Tuning Properties

Parameter tab

Detailed setting for parameter is displayed.

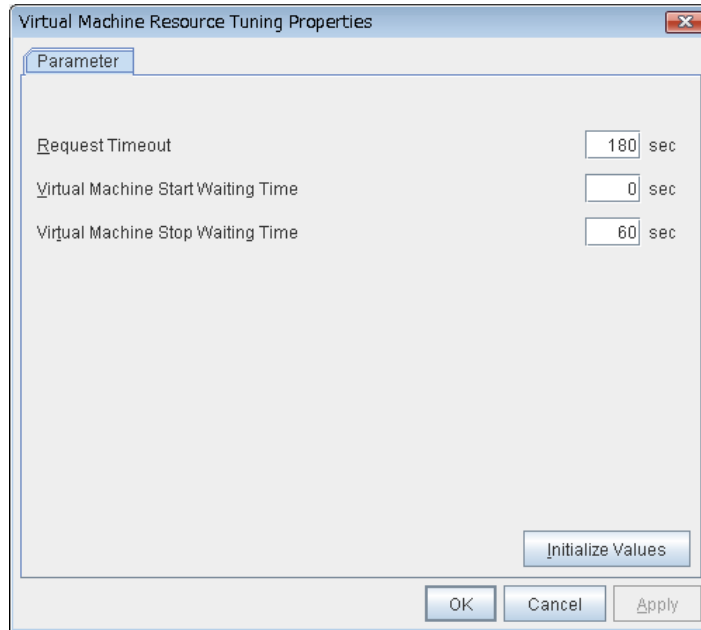

Request Timeout

Specify how long the system waits for completion of a request such as to start or stop a virtual machine

If the request is not completed within this time, a timeout occurs and resource activation or deactivation fails.

Virtual Machine Start Waiting Time

Specify the wait time to wait for the startup completion of the guest OS on the virtual machine and the application after the request to the virtual machine to start up completes and the status of the virtual machine becomes running at the resource activation.

Virtual Machine Stop Waiting Time

Specify the wait time for the shutdown of the guest OS on the virtual machine at the resource deactivation.

Initialize

Clicking **Initialize** sets the values of all the items to the defaults.

Displaying the VM resource properties with the WebManager

1. Start the WebManager (http://Management IP address or the IP address of the cluster server:port_number (the default value is 29003)).
2. Click the object for VM resource,  in the tree view. the following information is displayed in the list view.

Virtual Machine Name: vm1		Details
<div style="display: flex; border-bottom: 1px solid black;"> <div style="border-right: 1px solid black; padding: 2px 5px;">Common</div> <div style="border-right: 1px solid black; padding: 2px 5px;">server1</div> <div style="padding: 2px 5px;">server2</div> </div>		
Properties	Value	
Comment		
VM Type	hyper-v	
VM Name	vm1	
Status	Online	
Started Server	server1	

Comment: Comment on the VM resource
 VM Type: Virtual machine virtualization infrastructure
 VM Name: Virtual machine name
 Status: Status of VM resources
 Started Server: The server which the resource has started

When you click **Details**, the following information is displayed.

Properties	Value
Name	vm1
Type	vm
Failover Target Server	Stable Server
Failover Threshold	Number of Servers
Retry Count at Activation Failure	5
Final Action at Activation Failure	No operation (not activate next resource)
Execute Script before Final Action	Off
Retry Count at Deactivation Failure	0
Final Action at Deactivation Failure	No operation (not deactivate next resource)
Execute Script before Final Action	Off
Dependent Resources	
Retry Interval at Activation Failure	5
Retry Interval at Inactivation Failure	5
VM Config File Path	X:\wm0
Timeout Of Request (seconds)	180
Timeout Of Start (seconds)	0
Timeout Of Stop (seconds)	60

Name: Virtual machine resource name
 Type: Resource type
 Failover Target Server: Failover destination determination method
 Failover Threshold: Maximum number of times failing over is performed when an activation error is detected
 Retry Count at Activation Failure: Maximum number of times activation is retried when an activation error is detected
 Final Action at Activation Failure: Final action when an activation error occurs
 Execute Script before Final Action : Whether to execute scripts when an activation error occurs
 Retry Count at Deactivation Failure: Maximum number of times deactivation is retried when a deactivation error is detected
 Final Action at Deactivation Failure: Final action at a deactivation error
 Execute Script before Final Action: Whether to execute scripts when a deactivation error occurs

Dependent Resources:	Dependent resource
Retry Interval at Activation Failure:	Activation retry interval upon activation failure detection
Retry Interval at Inactivation Failure:	Deactivation retry interval upon inactivation failure detection
VM Config File Path:	The path of the configuration file of the virtual machine
Timeout Of Request (seconds):	Time out of the virtual machine control processing
Timeout Of Start (seconds):	Wait time for the guest OS to start
Timeout Of Stop (seconds):	Wait time for the guest OS to stop

Understanding AWS elastic ip resources

Dependencies of AWS elastic ip resources

By default, this function does not depend on any group resource type.

What is an AWS elastic ip resource?

By using this resource, an HA cluster can be configured with EXPRESSCLUSTER using the Amazon Virtual Private Cloud (referred to as the VPC) in the Amazon Web Services (referred to as AWS) environment.

This makes it possible to perform more important business operations in the same environment, increasing the number of choices for the system configuration in the AWS environment. AWS is configured robustly in multiple Availability Zones (referred to as AZs) in each area (region), enabling the user to select an AZ according to his or her needs. EXPRESSCLUSTER enables an HA cluster among multiple AZs (referred to as multi-AZ), achieving high availability of business operations.

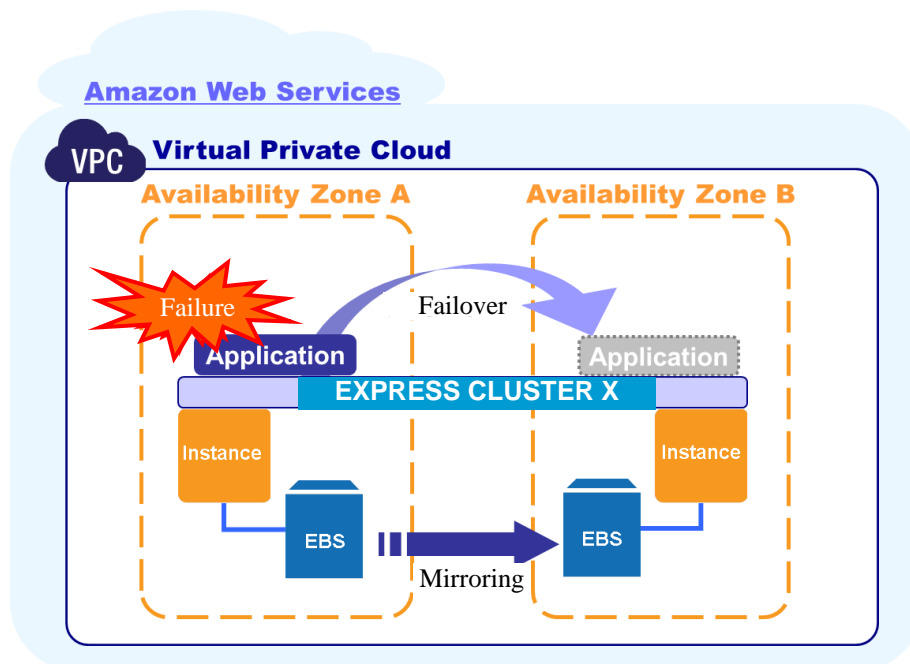

Fig. 1 Mirror type HA cluster in a multi-AZ configuration

Two types of HA clusters with the data mirror method are assumed, "HA cluster with VIP control" and "HA cluster with EIP control". This section describes AWS elastic ip resources that are used for "HA cluster with EIP control".

HA cluster with EIP control

This is used to place instances on public subnets (release business operations inside the VPC).

A configuration such as the following is assumed: Instances to be clustered are placed on public subnets in each AZ, and each instance can access the Internet via the Internet gateway.

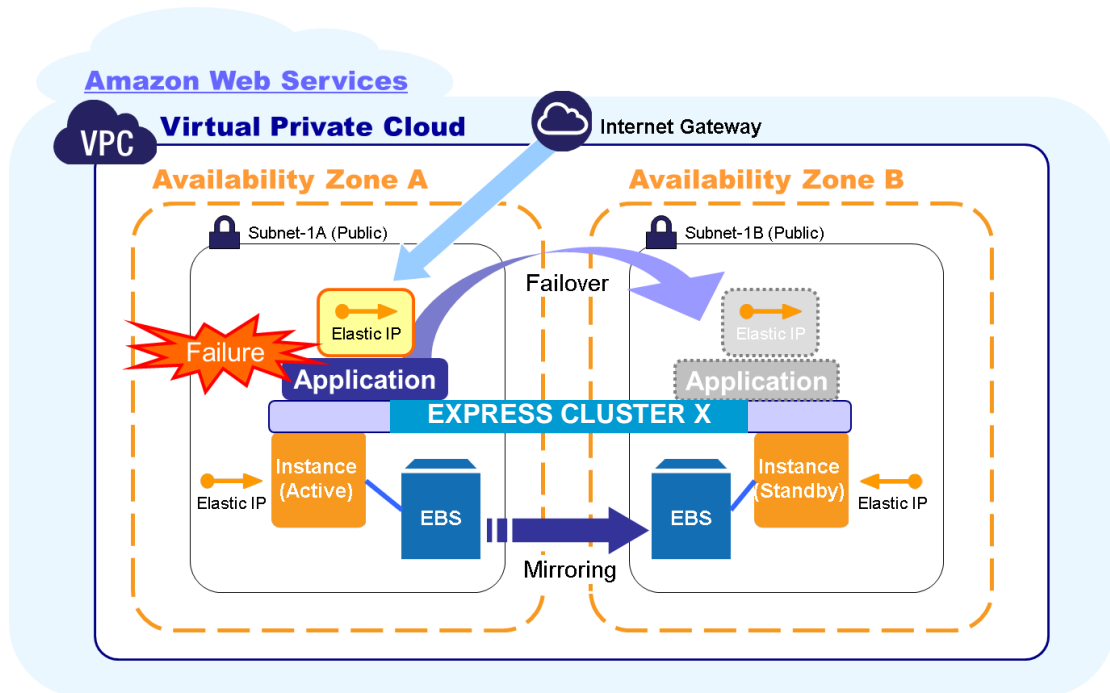

Fig. 2 HA cluster with EIP control

Notes on AWS elastic ip resources

- ◆ See "Setting up AWS elastic ip resources" in "Notes when creating the cluster configuration data" in Chapter 5, "Notes and Restrictions" in the *Getting Started Guide*.

Applying environment variables to AWS CLI run from the AWS elastic ip resource

Specify environment variables in the environment variable configuration file to apply environment variables to the AWS CLI run from the AWS Elastic ip resource, AWS virtual ip resource, AWS Elastic ip monitor resource and AWS AZ monitor resource.

This feature is useful when using a proxy server in an AWS environment.

The environment variable file is stored in the following location.

When the internal version is 11.33 or earlier, or the version is updated to 11.34, an environment configuration setting file does not exist. Create this file in such cases.

<EXPRESSCLUSTER Installation path>\cloud\aws\clpaws_setting.conf

The format of the environment variable configuration file is as follows:

Environment variable name = Value

(Example)

[ENVIRONMENT]

HTTP_PROXY = http://10.0.0.1:3128

HTTPS_PROXY = http://10.0.0.1:3128

The specifications of the environment variable file are as follows:

- ◆ Write [ENVIRONMENT] on the first line. If this is not set, the environment variables will not be set.
- ◆ If the environment variable configuration file does not exist or you do not have read permission for the file, the variables are ignored. This does not cause an activation failure or a monitor error.
- ◆ If the same environment variables already exists in the file, the values are overwritten.
- ◆ More than one variable can be set. Set one variable on each line.
- ◆ The settings are valid regardless of whether there are spaces before and after “=” or not.
- ◆ The settings are invalid if there is a space or tab in front of the environment variable name or if there are tabs before and after “=”.
- ◆ Environment variable names are case sensitive.
- ◆ If a value contains spaces, you do not have to enclose the spaces in “” (double quotation marks).

Displaying and changing AWS elastic ip resources details

1. In the tree view in the left pane of the Builder, click the icon of the group to which the AWS elastic ip resource whose detailed information you can to display and change belongs.
2. A list of group resources is shown on the table view in the right pane of the screen. Right-click the target AWS elastic ip resource name and then click the **Details** tab of **Properties**.
3. Display and/or change the detailed settings on the **Details** tab as described below.

AWS elastic ip Resource Properties: Details tab

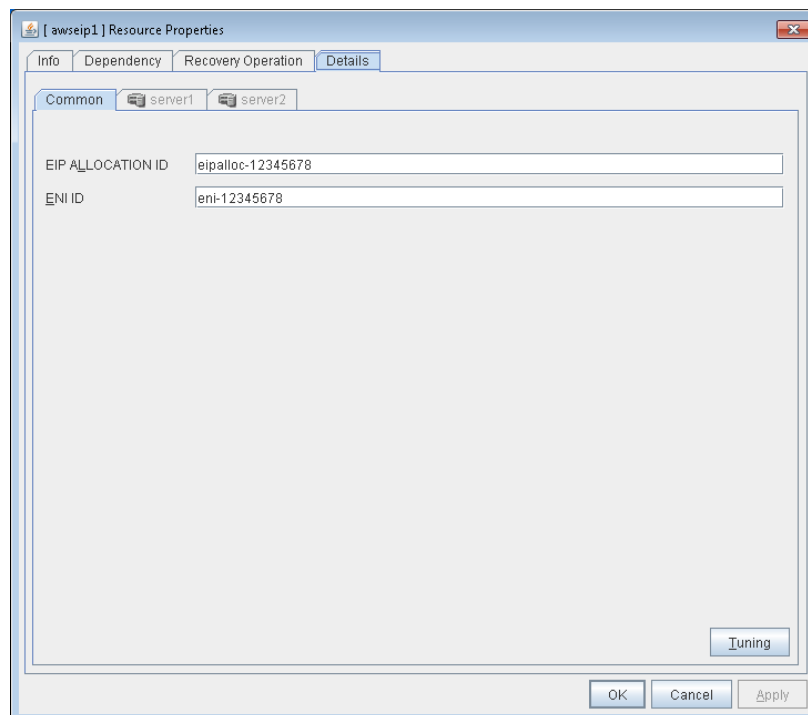

EIP ALLOCATION ID (Within 45 bytes) `GroupStopRestart`

For EIP control, specify the ID of the EIP to replace.

ENI ID (Within 45 bytes) `GroupStopRestart`

For EIP control, specify the ENI ID to which to allocate an EIP.

In the [common] tab, described the ENI ID of any of the server, the other server, please to perform the individual settings.

Tuning AWS elastic ip resource

1. In the tree view shown on the left pane of the Builder, click the icon of the group to which the AWS elastic ip resource whose detailed information you want to display and change belongs.
2. The group resource list is shown on the table view in the right pane of the screen. Right-click the desired AWS elastic ip resource name. Then click **Properties** and select the **Details** tab.
3. Click **Tuning** on the **Details** tab. The **AWS elastic ip Resource Tuning Properties** dialog box is displayed.
4. On the **Details** tab, you can see and/or change the settings of monitor resource by following the description below.

Parameter tab

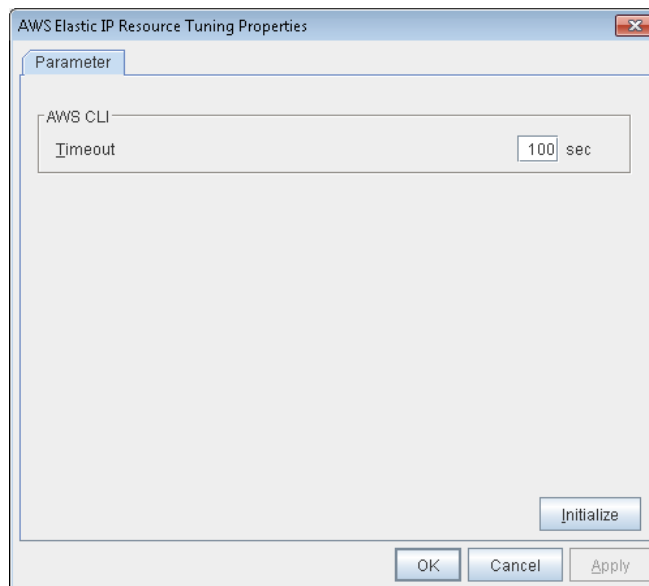

Timeout (1 to 999) `GroupStopRestart`

Make the setting of the timeout of AWS CLI command executed for the activation and/or deactivation of the AWS elastic ip resource and AWS elastic ip monitor resource.

Displaying the AWS elastic ip resource properties with the WebManager

1. Start the WebManager. (http://Management IP address or the IP address of the cluster server: port_number (the default value is 29003))
2. When you click an object for the AWS elastic ip resources  in the tree view, the following information is displayed in the list view.

AWS Elastic IP: awseip1		Details
Common server1 server2		
Properties	Value	
Comment		
EIP ALLOCATION ID	eipalloc-12345678	
ENI ID	eni-12345678	
Status	Offline	
Started Server		

Comment:	Comment for the AWS elastic ip resource
EIP ALLOCATION ID	EIP ALLOCATION ID
ENI ID	EIP ENI ID
Status:	Status of the AWS elastic ip resource
Started Server	The server which the resource has started.

When you click **Details**, the following information is displayed in the pop-up dialog box.

Properties	Value
Name	awseip1
Type	awseip
Failover Target Server	Stable Server
Failover Threshold	Number of Servers
Retry Count at Activation Failure	5
Final Action at Activation Failure	No operation (not activate next resource)
Execute Script before Final Action	Off
Retry Count at Deactivation Failure	0
Final Action at Deactivation Failure	Stop the cluster service and shutdown OS
Execute Script before Final Action	Off
Dependent Resources	
Retry Interval at Activation Failure	5
Retry Interval at Inactivation Failure	5
AWS CLI Timeout (sec)	100

Name:	AWS elastic ip resource name
Type:	Resource type
Failover Target Server:	Determination method of Failover Target Server
Failover Threshold:	Failover count at activation failures
Retry Count at Activation Failure:	Activation retry count at activation failures
Final Action at Activation Failure:	Final action at activation failures
Execute Script before Final Action:	Whether or not a script is executed upon activation failure
Retry Count at Deactivation Failure:	Deactivation retry countat deactivation failures
Final Action at Deactivation Failure:	Final action at deactivation failures
Execute Script before Final Action:	Whether or not a script is executed upon deactivation failure
Dependent Resources:	Dependent resources

Retry Interval at Activation Failure:	Activation retry interval upon activation failure detection
Retry Interval at Inactivation Failure:	Deactivation retry interval upon inactivation failure detection
AWS CLI Timeout (sec)	AWS CLI timeout

Understanding AWS virtual ip resources

Dependencies of AWS virtual ip resources

By default, this function does not depend on any group resource type.

What is an AWS virtual ip resource?

By using this resource, an HA cluster can be configured with ExpressCluster using the Amazon Virtual Private Cloud (referred to as the VPC) in the Amazon Web Services (referred to as AWS) environment.

This makes it possible to perform more important business operations in the same environment, increasing the number of choices for the system configuration in the AWS environment. AWS is configured robustly in multiple Availability Zones (referred to as AZs) in each area (region), enabling the user to select an AZ according to his or her needs. ExpressCluster enables an HA cluster among multiple AZs (referred to as multi-AZ), achieving high availability of business operations.

AWS CLI command is executed for AWS virtual ip resource when it is activated to update the route table information.

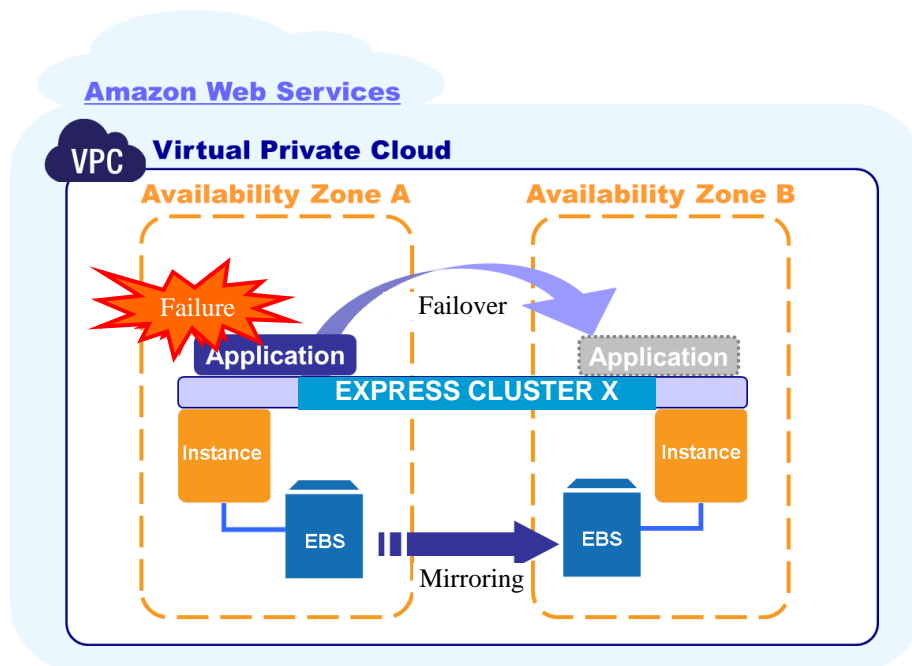

Fig. 1 Mirror type HA cluster in a multi-AZ configuration

Two types of HA clusters with the data mirror method are assumed, "HA cluster with VIP control" and "HA cluster with EIP control". This section describes AWS virtual ip resources that are used for "HA cluster with VIP control"

HA cluster with VIP control

This is used to place instances on private subnets (release business operations inside the VPC).

A configuration such as the following is assumed: Instances to be clustered, as well as the instance group accessing the instances, are placed on private subnets in each AZ, and each instance can access the Internet via the NAT instance placed on the public subnet.

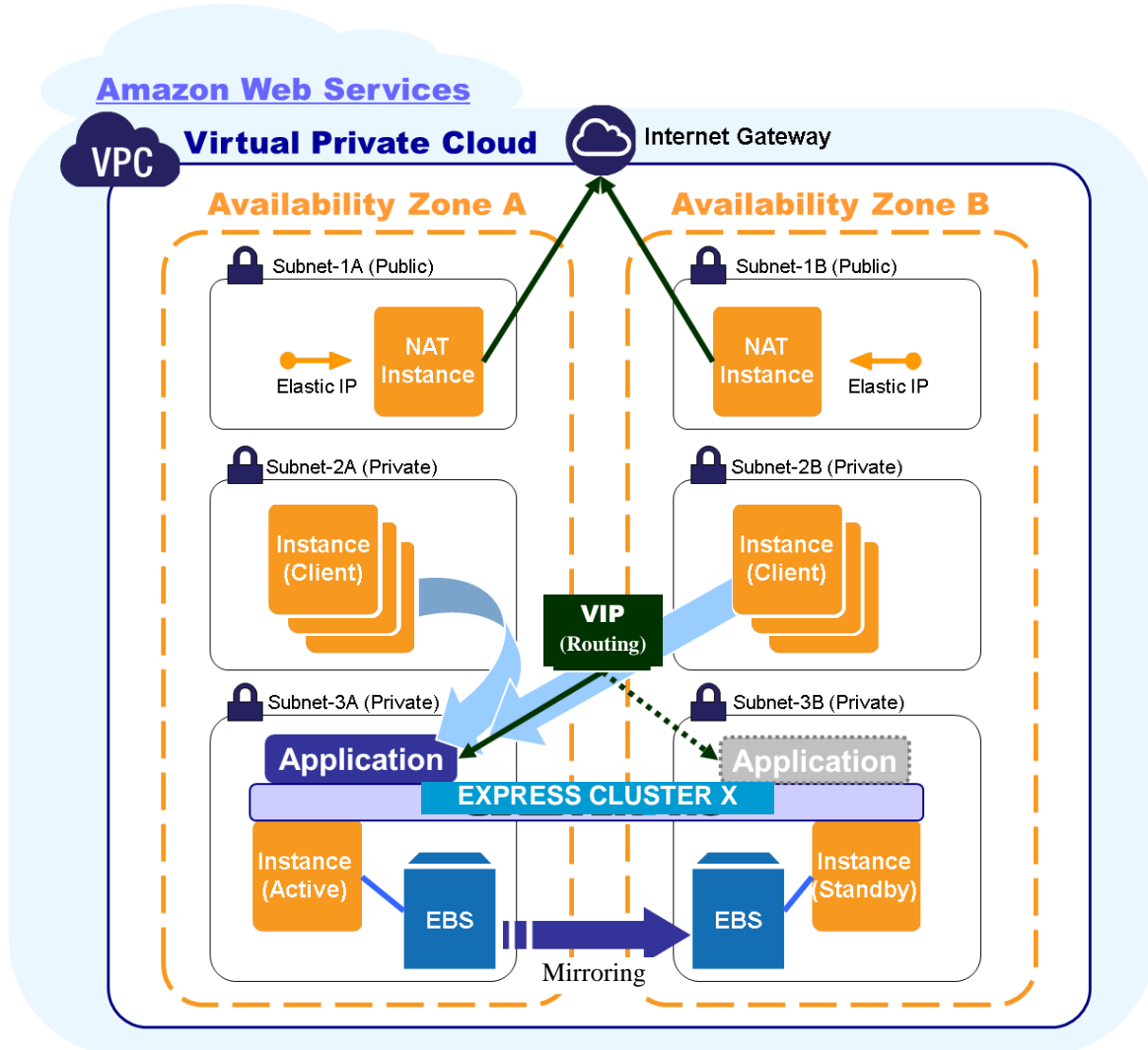

Fig. 2 HA cluster with VIP control

Notes on AWS virtual ip resources

- ◆ See "Setting up AWS virtual ip resources" in "Notes when creating the cluster configuration data" in Chapter 5, "Notes and Restrictions" in the *Getting Started Guide*.

Applying environment variables to AWS CLI run from the AWS virtual ip resource

Specify environment variables in the environment variable configuration file to apply environment variables to the AWS CLI run from the AWS Elastic ip resource, AWS virtual ip resource, AWS Elastic ip monitor resource and AWS AZ monitor resource.

This feature is useful when using a proxy server in an AWS environment.

The environment variable file is stored in the following location.

When the internal version is 11.33 or earlier, or the version is updated to 11.34, an environment configuration setting file does not exist. Create this file in such cases.

<EXPRESSCLUSTER Installation path>\cloud\aws\clpaws_setting.conf

The format of the environment variable configuration file is as follows:

Environment variable name = Value

(Example)

[ENVIRONMENT]

HTTP_PROXY = http://10.0.0.1:3128

HTTPS_PROXY = http://10.0.0.1:3128

The specifications of the environment variable file are as follows:

- ◆ Write [ENVIRONMENT] on the first line. If this is not set, the environment variables will not be set.
- ◆ If the environment variable configuration file does not exist or you do not have read permission for the file, the variables are ignored. This does not cause an activation failure or a monitor error.
- ◆ If the same environment variables already exists in the file, the values are overwritten.
- ◆ More than one variable can be set. Set one variable on each line.
- ◆ The settings are valid regardless of whether there are spaces before and after “=” or not.
- ◆ The settings are invalid if there is a space or tab in front of the environment variable name or if there are tabs before and after “=”.
- ◆ Environment variable names are case sensitive.
- ◆ If a value contains spaces, you do not have to enclose the spaces in “” (double quotation marks).

Displaying and changing AWS virtual ip resources details

1. In the tree view in the left pane of the Builder, click the icon of the group to which the AWS virtual ip resource whose detailed information you can to display and change belongs.
2. A list of group resources is shown on the table view in the right pane of the screen. Right-click the target AWS virtual ip resource name and then click the **Details** tab of **Properties**.
3. Display and/or change the detailed settings on the **Details** tab as described below.

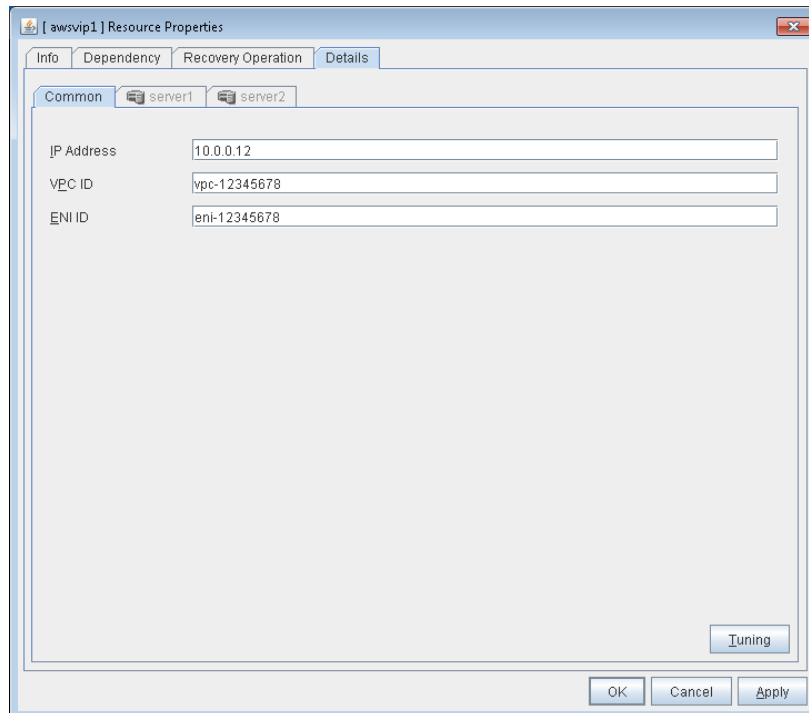
AWS virtual ip Resource Properties: Details tab**IP Address (Within 45 bytes) `GroupStopRestar`**

For VIP control, specify the VIP address to use.

VPC ID (Within 45 bytes) `GroupStopRestar`

For VIP control, specify the VPC ID to which the server belongs. To specify an individual VPC ID to servers, enter a VPC ID of any server on the Common tab and specify a VPC ID for other servers individually. For how to set routing, see AWS elastic ip resources, AWS virtual ip resources, AWS elastic ip monitor resources, AWS virtual ip monitor resources, AWS AZ monitor resources in Chapter 9, "Information on other setting".

ENI ID (Within 45 bytes) `GroupStopRestar`

For VIP control, specify the ENI ID of VIP routing destination. For the ENI ID to specify, Source/Dest. Check must be disabled beforehand. This must be set for each server. On the Common tab, enter the ENI ID of any server, and specify an ENI ID for the other servers individually.

Tuning

Opens the **AWS virtual ip resource tuning properties** dialog box where the detailed settings for the AWS virtual ip resource tuning properties can be configured.

Server Individual Setup

Opens the Server Individual Setup dialog box. Set the ENI ID and VPC ID which are different depending on a server.

Tuning AWS virtual ip resource

1. In the tree view shown on the left pane of the Builder, click the icon of the group to which the AWS virtual ip resource whose detailed information you want to display and change belongs.
2. The list of group resources is shown in the table view on the right side of the screen. Right-click the desired AWS virtual ip resource name. Then click **Properties** and select the **Details** tab.
3. Click Tuning on the **Details** tab. The **AWS virtual ip Resource Tuning Properties** dialog box is displayed.
4. On the **Details** tab, you can see and/or change the settings by following the description below.

Parameter tab

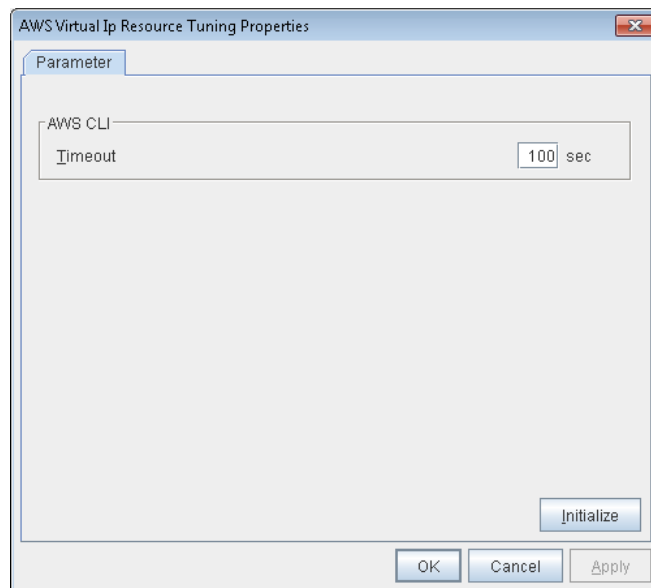

Timeout (1 to 999) **GroupStopRestart**

Set the timeout of the AWS CLI command to be executed for AWS virtual ip resource activation/deactivation.

Displaying the property of the AWS virtual ip resource with the WebManager

1. Start the WebManager. (http://Management IP address or the IP address of the cluster server: port_number (the default value is 29003))
2. When you click an object for the AWS virtual ip resources  in the tree view, the following information is displayed in the list view.

AWS Virtual IP: awsvip1		Details
Common server1 server2		
Properties	Value	
Comment		
IP Address	10.0.0.12	
VPC ID	vpc-12345678	
ENI ID	eni-12345678	
Status	Offline	
Started Server		

Comment: Comment for the AWS virtual ip resource
IP Address: VIP IP address
VPC ID: VIP VPC ID
ENI ID: VIP ENI ID
Status: Status of the AWS virtual ip resource
Started Server: The server which the resource has started.

When you click **Details**, the following information is displayed in the pop-up dialog box.

Properties	Value
Name	awsvip1
Type	awsvip
Failover Target Server	Stable Server
Failover Threshold	Number of Servers
Retry Count at Activation Failure	5
Final Action at Activation Failure	No operation (not activate next resource)
Execute Script before Final Action	Off
Retry Count at Deactivation Failure	0
Final Action at Deactivation Failure	Stop the cluster service and shutdown OS
Execute Script before Final Action	Off
Dependent Resources	
Retry Interval at Activation Failure	5
Retry Interval at Inactivation Failure	5
AWS CLI Timeout (sec)	100

Name: AWS virtual ip resource name
Type: Resource type
Failover Target Server: Determination method of Failover Target Server
Failover Threshold: Failover count at activation failures
Retry Count at Activation Failure: Activation retry count at activation failures
Final Action at Activation Failure: Final action at activation failures
Execute Script before Final Action: Whether or not a script is executed upon activation failure
Retry Count at Deactivation Failure: Deactivation retry count at deactivation failures
Final Action at Deactivation Failure: Final action at deactivation failures
Execute Script before Final Action: Whether or not a script is executed upon deactivation failure
Dependent Resources: Dependent resources
Retry Interval at Activation Failure: Activation retry interval upon activation failure detection
Retry Interval at Inactivation Failure: Deactivation retry interval upon inactivation failure detection
AWS CLI Timeout (sec): AWS CLI timeout

Understanding Azure probe port resources

Dependencies of Azure probe port resources

By default, this function does not depend on any group resource type.

What is an Azure probe port resource?

By using this resource, you can create an HA cluster using virtual machines on a cloud service in the Microsoft Azure environment.

By making the virtual machines placed in different fault domains of Microsoft Azure into a cluster, even higher availability of applications is achieved.

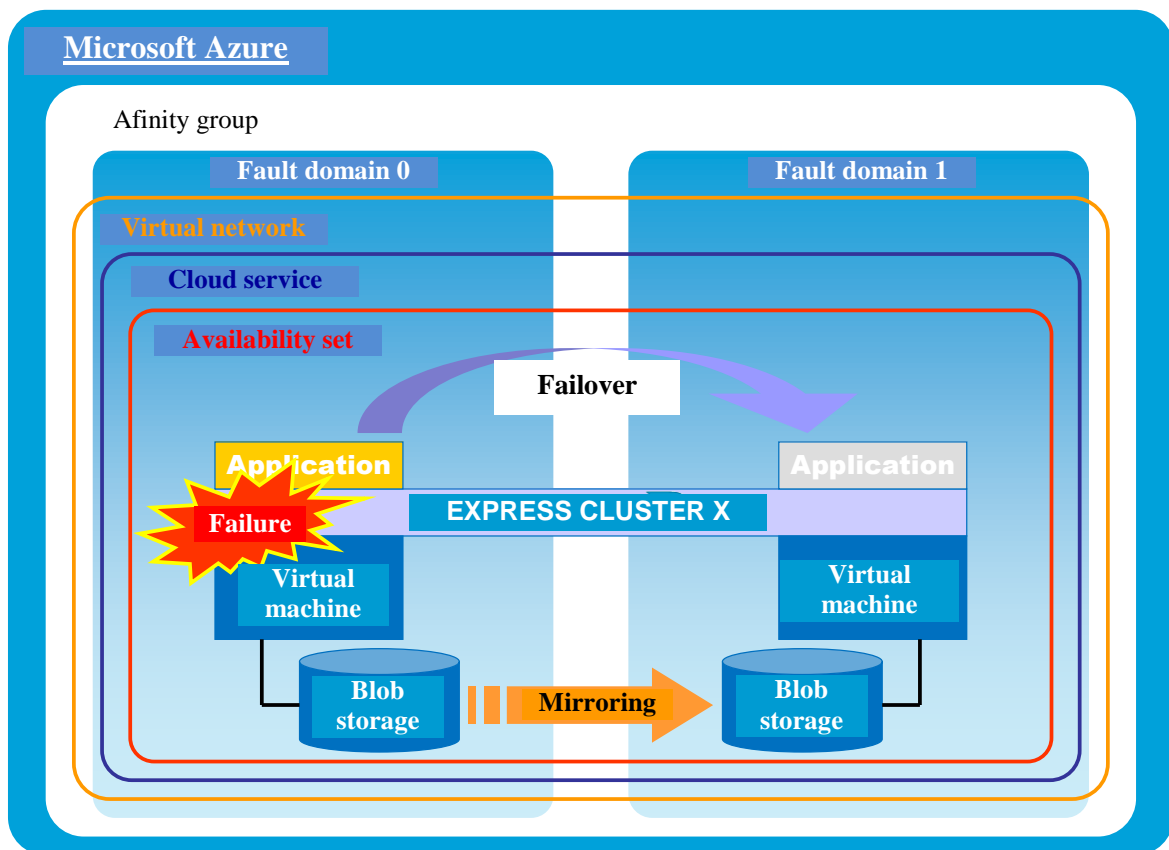

Fig. 1 Mirror type HA cluster on a cloud service

An HA cluster with the data mirror method is assumed.

In this configuration, an availability set is used, and the two virtual machines to make into a cluster are placed on the racks physically separated in the data center. For this reason, even if an error occurs on one physical server, it is possible to prevent the two virtual machines from being shut down simultaneously. They belong to the same cloud service to gain access to the cluster with the same DNS name.

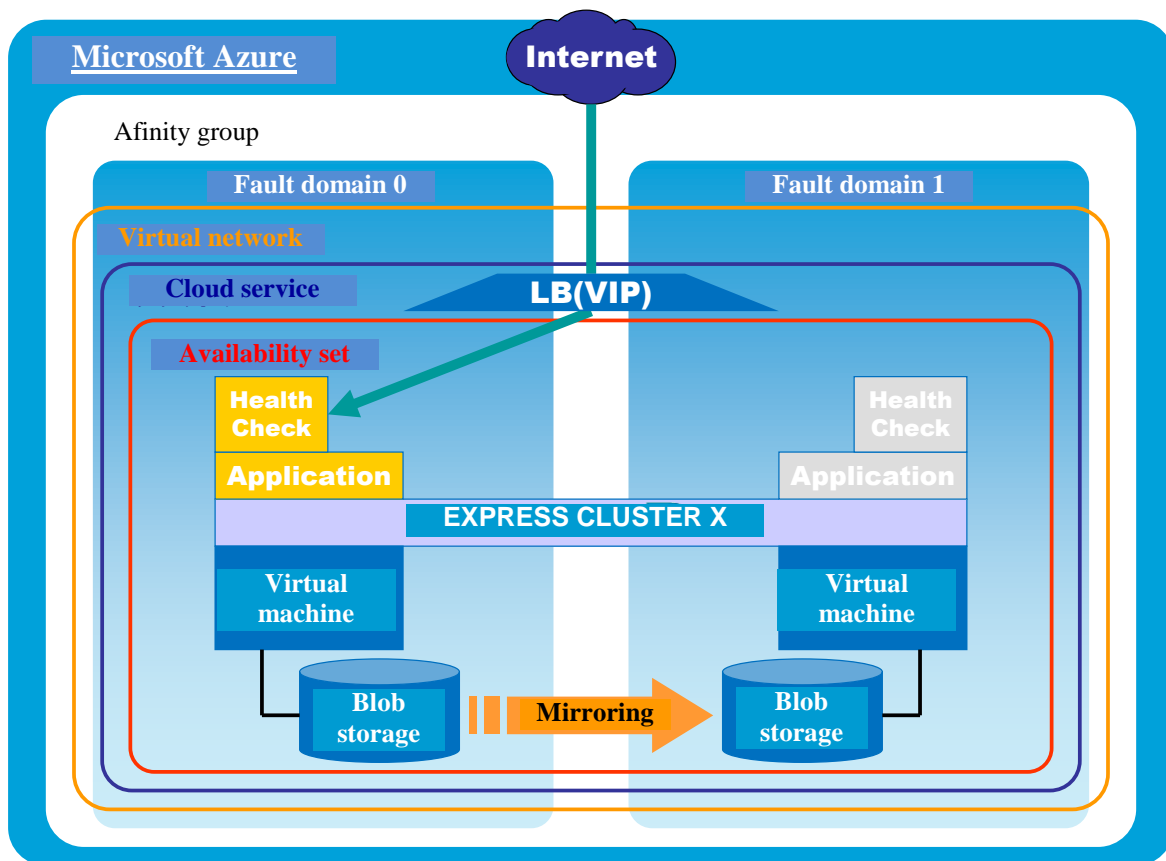

Fig. 2 HA cluster with load balance switching to an end point

To access the cluster created on the Microsoft Azure environment in the figure above, specify the end point for communicating from the outside with the global IP address called a public virtual IP (VIP) address (referred to as a VIP in the remainder of this document) or the end point for communicating from the outside with the DNS name. The active and standby nodes of the cluster are switched by controlling the Microsoft Azure load balancer (LB in the figure above) from EXPRESSCLUSTER. For control, Health Check in the figure above is used.

At activation, start the probe port control process for waiting for alive monitoring (access to the probe port) from the Azure load balancer.

At deactivation, stop the probe port control process for waiting for alive monitoring (access to the probe port).

Azure probe port resources also support the Internal Load Balancing of Microsoft Azure. For Internal Load Balancing, the VIP is the private IP address of Azure.

Notes on Azure probe port resources

- If the private port and the probe port are the same, you need not add Azure probe port resources or Azure probe port monitor resources.
- See “Setting up Azure probe port resources” on “Notes when creating the cluster configuration data” in Chapter 5 “Notes and Restrictions” of the *Getting Started Guide*.

Displaying and changing the details of Azure probe port resources

1. In the tree view shown on the left pane of the Builder, click the icon of the group to which the Azure probe port resource whose detailed information you want to display and change belongs.
2. The list of group resources is shown in the table view on the right side of the screen. Right-click the desired Azure probe port resource name. Then click **Properties** and select the **Details** tab.
3. On the **Details** tab, you can display and/or change the settings by following the description below.

Azure probe port Resource Properties: Details tab

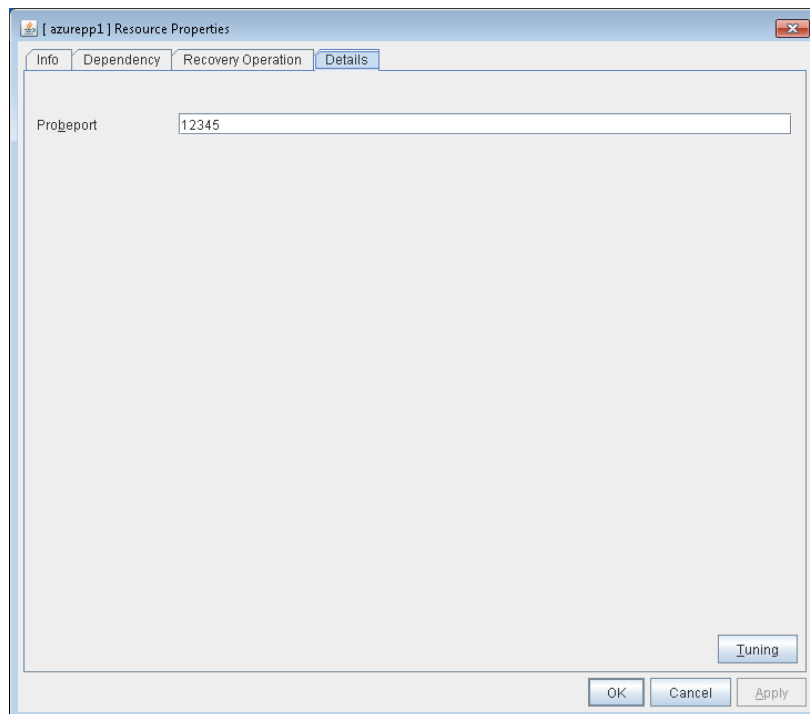

Probe port (1 to 65535) **GroupStopRestart**

Specify the port number used by the Azure load balancer for the alive monitoring of each server. Specify the value specified for Probe Port when creating an end point. For Probe Protocol, specify TCP.

Tuning

Display the **Azure probe port Resource Tuning Properties** dialog box. Specify detailed settings for the Azure probe port resources.

Tuning Azure probe port resource

1. In the tree view shown on the left pane of the Builder, click the icon of the group to which the Azure probe port resource whose detailed information you want to display and change belongs.
2. The list of group resources is shown in the table view on the right side of the screen. Right-click the desired Azure probe port resource name. Then click **Properties** and select the **Details** tab.
3. Click **Tuning** on the **Details** tab. The **Azure probe port Resource Tuning Properties** dialog box is displayed.
4. On the **Details** tab, you can display and/or change the settings by following the description below.

Parameter tab

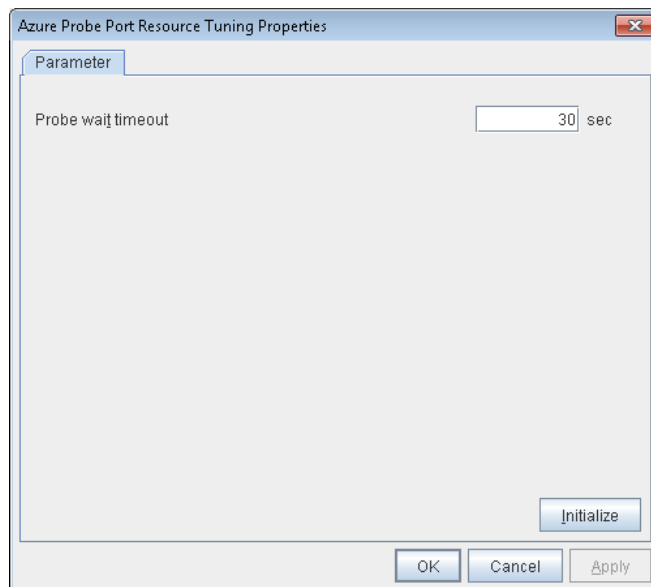

Probe wait timeout (5 to 999999999) **GroupStopRestart**

Specify the timeout time for waiting alive monitoring from the Azure load balancer. Check if alive monitoring is performed periodically from the Azure load balancer.

Displaying the Azure probe port resource properties with the WebManager

1. Start the WebManager. (http://Management IP address or the IP address of the cluster server: port_number (the default value is 29003))
2. When you click an Azure probe port resource object  in the tree view, the following information is displayed in the list view.

Azure probe port: azurepp1		Details
Common server1 server2		
Properties	Value	
Comment		
Probe Port	12345	
Status	Offline	
Started Server		

Comment Azure probe port resource comment
Probe Port Port number used for the alive monitoring of each server
Status Status of the Azure probe port resource
Started Server The server which the resource has started

When you click **Details**, the following information is displayed in the pop-up dialog box:

Properties	Value
Name	azurepp1
Type	azurepp
Failover Target Server	Stable Server
Failover Threshold	Number of Servers
Retry Count at Activation Failure	5
Final Action at Activation Failure	No operation (not activate next resource)
Execute Script before Final Action	Off
Retry Count at Deactivation Failure	0
Final Action at Deactivation Failure	Stop the cluster service and shutdown OS
Execute Script before Final Action	Off
Dependent Resources	
Retry Interval at Activation Failure	5
Retry Interval at Inactivation Failure	5
Probe Timeout (sec)	30

Name: Azure probe port resource name
Type: Resource type
Failover Target Server: Determination method of Failover Target Server
Failover Threshold: The number of failovers to be made at detection of an error
Retry Count at Activation Failure: The number of times activation is retried when an activation error is detected
Final Action at Activation Failure: Final action at an activation error
Execute Script before Final Action: Whether or not script is executed at an activation error
Retry Count at Deactivation Failure: The number of times deactivation is retried when a deactivation error is detected
Final Action at Deactivation Failure: Final action at a deactivation error
Execute Script before Final Action: Whether or not script is executed at a deactivation error
Dependent Resources: Dependent resources
Retry Interval at Activation Failure: Activation retry interval when an activation error is detected
Retry Interval at Deactivation Failure: Deactivation retry interval when a deactivation error is detected
Probe Timeout (sec): Timeout time for waiting alive monitoring

Chapter 6 Monitor resource details

This chapter provides detailed information on monitor resources. Monitor resource is a unit to perform monitoring.

This chapter covers:

- Monitor resources 743
- Displaying and changing the settings of a monitor resource (common to monitor resources) 792
- Understanding application monitor resources 804
- Understanding disk RW monitor resources 806
- Understanding floating IP monitor resources 811
- Understanding IP monitor resources 815
- Understanding mirror connect monitor resources 820
- Understanding mirror disk monitor resources 824
- Understanding NIC link up/down monitor resources 828
- Understanding multi target monitor resources 832
- Understanding registry synchronization monitor resources 837
- Understanding disk TUR monitor resources 839
- Understanding service monitor resources 843
- Understanding print spooler monitor resources 846
- Understanding virtual computer name monitor resources 848
- Understanding dynamic DNS monitor resources 851
- Understanding virtual IP monitor resources 855
- Understanding CIFS monitor resources 857
- Understanding NAS monitor resources 862
- Understanding hybrid disk monitor resources 865
- Understanding hybrid disk TUR monitor resources 869
- Understanding custom monitor resources 873
- Understanding message receive monitor resources 878
- Understanding VM monitor resources 884
- Understanding process name monitor resources 886
- Understanding DB2 monitor resources 891
- Understanding FTP monitor resources 896
- Understanding HTTP monitor resources 900
- Understanding IMAP4 monitor resources 904
- Understanding ODBC monitor resources 908
- Understanding Oracle monitor resources 913
- Understanding OracleAS monitor resources 922
- Understanding OfficeScan CL monitor resource 927
- Understanding OfficeScan SV monitor resource 930
- Understanding POP3 monitor resources 932
- Understanding PostgreSQL monitor resources 936
- Understanding SMTP monitor resources 943
- Understanding SQL Server monitor resources 948
- Understanding Tuxedo monitor resources 954
- Understanding Websphere monitor resources 958
- Understanding Weblogic monitor resources 963
- Understanding WebOTX monitor resources 968
- Understanding JVM monitor resources 972

- Understanding system monitor resources.....1019
- Understanding user space monitor resources1035
- Understanding AWS elastic ip monitor resources.....1040
- Understanding AWS virtual ip monitor resources1044
- Understanding AWS AZ monitor resources.....1048
- Understanding Azure probe port monitor resources.....1052
- Understanding Azure load balance monitor resources1056

Monitor resources

A monitor resource refers to a resource that monitors a specified target to be monitored. When detecting an error in a target to be monitored, a monitor resource restarts a group resource and/or executes failover.

Currently supported monitor resource are as follows:

Monitor resource name	Abbreviation	Functional overview
Application monitor resources	appliw	Refer to "Understanding application monitor resources" on page 804.
Disk RW monitor resources	diskw	Refer to "Understanding disk RW monitor resources" on page 806.
Floating IP monitor resources	fipw	Refer to "Understanding floating IP monitor resources" on page 811.
IP monitor resources	ipw	Refer to "Understanding IP monitor resources" on page 815.
Mirror connect monitor resources	mdnw	Refer to "Understanding mirror connect monitor resources" on page 820.
Mirror disk monitor resources	mdw	Refer to "Understanding mirror disk monitor resources" on page 824.
NIC Link Up/Down monitor resources	miiw	Refer to "Understanding NIC link up/down monitor resources" on page 828.
Multi target monitor resources	mtw	Refer to "Understanding multi target monitor resources" on page 832.
Registry synchronization monitor resources	regsyncw	Refer to "Understanding registry synchronization monitor resources" on page 837.
Disk TUR monitor resources	sdw	Refer to "Understanding disk TUR monitor resources" on page 839.
Service monitor resources	servicew	Refer to "Understanding service monitor resources" on page 843.
Print spooler monitor resources	spoolw	Refer to "Understanding print spooler monitor resources" on page 846.
Virtual computer name monitor resources	vcomw	Refer to "Understanding virtual computer name monitor resources" on page 848.
Dynamic DNS monitor resources	ddnsw	Refer to "Understanding dynamic DNS monitor resources" on page 851.
Virtual IP monitor resources	vipw	Refer to "Understanding virtual IP monitor resources" on page 855.
CIFS monitor resources	cifsw	Refer to "Understanding CIFS monitor resources" on page 857.
NAS monitor resources	nasw	Refer to "Understanding NAS monitor resources" on page 862.
Hybrid disk monitor resources	hdw	Refer to "Understanding hybrid disk monitor resources" on page 865.
Hybrid disk TUR monitor resources	hdtw	Refer to "Understanding hybrid disk TUR monitor resources" on page 869.
Custom monitor resources	genw	Refer to "Understanding custom monitor resources" on page 873.

Monitor resource name	Abbreviation	Functional overview
VM monitor resources	vmw	Refer to “Understanding VM monitor resources” on page 884
Message receive monitor resources	mrw	Refer to “Understanding message receive monitor resources” on page 878.
Process name monitor resources	psw	Refer to “Understanding process name monitor resources” on page 886.
DB2 monitor resources	db2w	Refer to “Understanding DB2 monitor resources” on page 891.
FTP monitor resources	ftpw	Refer to “Understanding FTP monitor resources” on page 896.
HTTP monitor resources	httpw	Refer to “Understanding HTTP monitor resources” on page 900.
IMAP4 monitor resources	imap4w	Refer to “Understanding IMAP4 monitor resources” on page 904.
ODBC monitor resources	odbcw	Refer to “Understanding ODBC monitor resources” on page 908.
Oracle monitor resources	oraclew	Refer to “Understanding Oracle monitor resources” on page 913.
OracleAS monitor resources	oracleasw	Refer to “Understanding OracleAS monitor resources on page 922.
OfficeScan CL monitor	oscw	Refer to “Understanding OfficeScan CL monitor resource” on page 927.
OfficeScan SV monitor	ossw	Refer to “Understanding OfficeScan SV monitor resource” on page 930.
POP3 monitor resources	pop3w	Refer to “Understanding POP3 monitor resources” on page 931.
PostgreSQL monitor resources	psqlw	Refer to “Understanding PostgreSQL monitor resources” on page 936.
SMTP monitor resources	smtpw	Refer to “Understanding SMTP monitor resources” on page 943.
SQL Server monitor resources	sqlserverw	Refer to “Understanding SQL Server monitor resources” on page 948.
Tuxedo monitor resources	tuxw	Refer to “Understanding Tuxedo monitor resources on page 954.
Websphere monitor resources	wasw	Refer to “Understanding Websphere monitor resources” on page 958.
Weblogic monitor resources	wls	Refer to “Understanding Weblogic monitor resources” on page 963.
WebOTX monitor resources	otw	Refer to “Understanding WebOTX monitor resources” on page 968.
JVM monitor resources	jrw	Refer to “Understanding JVM monitor resources” on page 972.
System monitor resources	srw	Refer to “Understanding system monitor resources” on page 1019.
User space monitor resources	usrw	Refer to “Understanding user space monitor resources” on page 1035.

Monitor resource name	Abbreviation	Functional overview
AWS elastic ip monitor resources	awseipw	Refer to “Understanding AWS elastic ip monitor resources” on page 1040.
AWS virtual ip monitor resources	awsvipw	Refer to “Understanding AWS virtual ip monitor resources” on page 1044.
AWS AZ monitor resources	awsazw	Refer to “Understanding AWS AZ monitor resources” on page 1048.
Azure probe port monitor resources	azureppw	Refer to “Understanding Azure probe port monitor resources” on page 1052.
Azure load balance monitor resources	azurelbw	Refer to “Understanding Azure load balance monitor resources” on page 1056.

Monitoring by monitor resources are done in one of two ways: monitoring the target all the time or monitoring the target when it is activated.

The initial settings for monitoring timings of each monitor resource are shown below.

The default settings are as follows.

- Always monitor (From the cluster startup to the cluster stop)
 - IP monitor resources
 - Mirror connect monitor resources
 - Mirror disk monitor resources
 - Hybrid disk monitor resources
 - Hybrid disk TUR monitor resources
 - NIC Link Up/Down monitor resources
 - Disk TUR monitor resources
 - Custom monitor resources
 - Message receive monitor resources
 - Process name monitor resources
 - OfficeScan CL monitor resource
 - System monitor resources
 - User space monitor resources
 - AWS AZ monitor resources
 - Azure load balance monitor resources
- Monitor while a group is activated (from activation to deactivation of the group)
 - Application monitor resources
 - Disk RW monitor resources
 - Floating IP monitor resources
 - Multi target monitor resources
 - Registry synchronization monitor resources

- Service monitor resources
- Print spooler monitor resources
- Virtual computer name monitor resources
- Dynamic DNS monitor resources
- Virtual IP monitor resources
- CIFS monitor resources
- NAS monitor resources
- VM monitor resources
- DB2 monitor resources
- FTP monitor resources
- HTTP monitor resources
- IMAP4 monitor resources
- ODBC monitor resources
- Oracle monitor resources
- OracleAS monitor resources
- OfficeScan SV monitor resource
- POP3 monitor resources
- PostgreSQL monitor resources
- SMTP monitor resources
- SQL Server monitor resources
- Tuxedo monitor resources
- Websphere monitor resources
- Weblogic monitor resources
- WebOTX monitor resources
- JVM monitor resources
- AWS elastic ip monitor resources
- AWS virtual ip monitor resources
- Azure probe port monitor resources

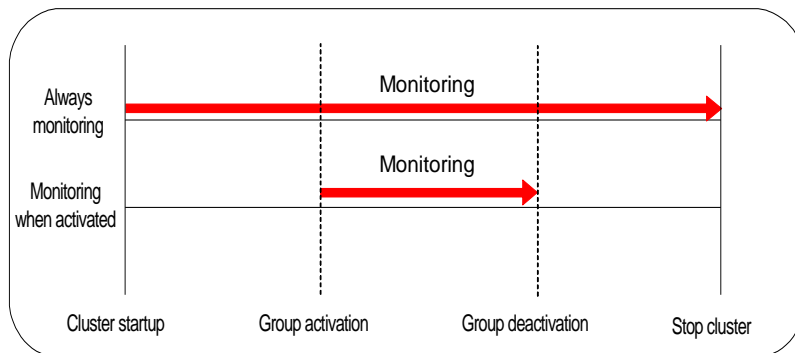

Monitor timing of monitor resources

Monitor resource	Monitor timing	Target resource
Application monitor resources	When activated (Fixed)	appli
Disk RW monitor resources	Always or when activated	All resources
Floating IP monitor resources	When activated (Fixed)	fip
IP monitor resources	Always or when activated	All resources
Mirror connect monitor resources	Always (Fixed)	-
Mirror disk monitor resources	Always (Fixed)	-
NIC link up/down monitor resources	Always or when activated	All resources
Multi target monitor resources	Always or when activated	All resources
Registry synchronization monitor resources	When activated (Fixed)	regsync
Disk TUR monitor resources	Always or when activated	sd
Service monitor resources	When activated (Fixed)	service
Print spooler monitor resources	When activated (Fixed)	spool
Virtual computer name monitor resources	When activated (Fixed)	vcom
Dynamic DNS monitor resources	When activated (Fixed)	ddns
Virtual IP monitor resources	When activated (Fixed)	vip
CIFS monitor resources	When activated (Fixed)	cifs
NAS monitor resources	When activated (Fixed)	Nas
Hybrid disk monitor resources	Always (Fixed)	-
Hybrid disk TUR monitor resources	Always or when activated	Hd
Custom monitor resources	Always or when activated	All resources
Message receive monitor resources	Always (Fixed)	-
VM monitor resources	When activated (Fixed)	vm
Process name monitor resources	Always or when activated	All resources
DB2 monitor resources	When activated (Fixed)	All resources
FTP monitor resources	When activated (Fixed)	All resources
HTTP monitor resources	When activated (Fixed)	All resources
IMAP4 monitor resources	When activated (Fixed)	All resources
ODBC monitor resources	When activated (Fixed)	All resources
Oracle monitor resources	When activated (Fixed)	All resources
OracleAS monitor resources	When activated (Fixed)	All resources
OfficeScan CL monitor	Always (Fixed)	-
OfficeScan SV monitor	When activated (Fixed)	All resources
POP3 monitor resources	When activated (Fixed)	All resources
PostgreSQL monitor resources	When activated (Fixed)	All resources
SMTP monitor resources	When activated (Fixed)	All resources
SQL Server monitor resources	When activated (Fixed)	All resources

Monitor resource	Monitor timing	Target resource
Tuxedo monitor resources	When activated (Fixed)	All resources
Websphere monitor resources	When activated (Fixed)	All resources
Weblogic monitor resources	When activated (Fixed)	All resources
WebOTX monitor resources	When activated (Fixed)	All resources
JVM monitor resources	Always or when activated	All resources
System monitor resources	Always (Fixed)	All resources
User space monitor resources	Always (Fixed)	-
AWS elastic ip monitor resources	When activated (Fixed)	awseip
AWS virtual ip monitor resources	When activated (Fixed)	awsvip
AWS AZ monitor resources	Always (Fixed)	-
Azure probe port monitor resources	When activated (Fixed)	azurepp
Azure load balance monitor resources	Always (Fixed)	azurepp

Enabling and disabling Dummy failure of monitor resources

You can enable and disable dummy failure of monitor resources.

Use one of the following methods to enable or disable dummy failure.

- ◆ Operation on WebManager (verification mode)
On the WebManager(Verification mode), shortcut menus of the monitor resources which cannot control monitoring are disabled.
- ◆ Operation by using the clpmonctrl command
The clpmonctrl command can control only monitor resources on the server where this command is run. When the clpmonctrl command is executed on monitor resource which cannot be controlled, dummy failure is not enabled even though the command succeeds.

Some monitor resources can enable and disable dummy failure and others cannot.

For details, see “Controlling monitor resources (clpmonctrl command)” in Chapter 3.

Dummy failure of a monitor resource is disabled if the following operations are performed.

- ◆ Dummy failure was disabled on WebManager (verification mode)
- ◆ “Yes” was selected from the dialog displayed when the WebManager mode changes from verification mode to a different mode.
- ◆ -n was specified to enable dummy failure by using the clpmonctrl command
- ◆ Stop the cluster
- ◆ Suspend the cluster

Monitoring interval for monitor resources

All monitor resources monitor their targets at every monitoring interval.

The following describes the timeline of how a monitor resource monitors its target and finds an error with the monitoring interval settings:

When no error is detected

Examples of behavior when the following values are set:

<Monitor>

Monitor Interval 30 sec

Monitor Timeout 60 sec

Monitor Retry Count 0 time

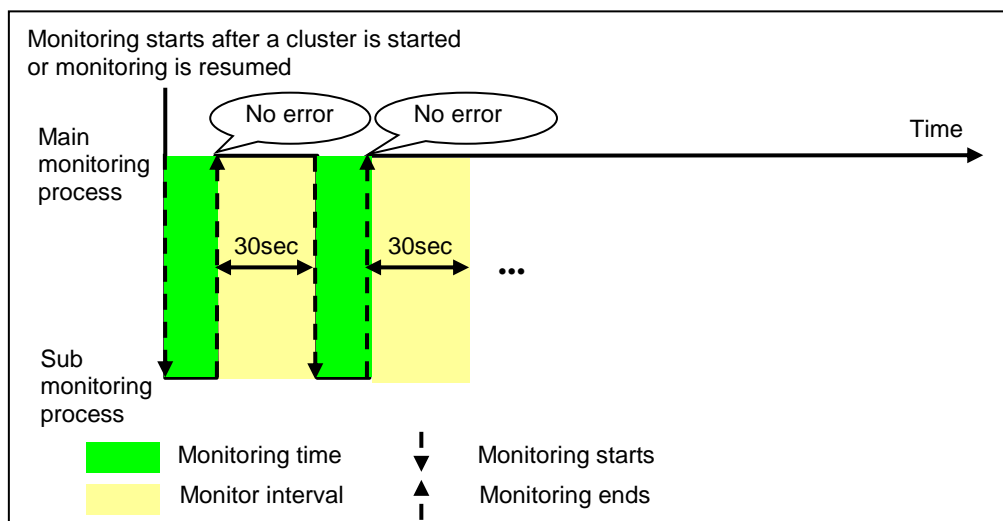

When an error is detected (without monitor retry setting)

Examples of behavior when the following values are set:

<Monitor>

Monitor Interval 30 sec
 Monitor Timeout 60 sec
 Monitor Retry count 0 time

<Error detection>

Recovery Target group
 Recovery Script Execution Count 0 time
 Reactivation Threshold 0 time
 Failover Threshold 1 time
 Final Action None

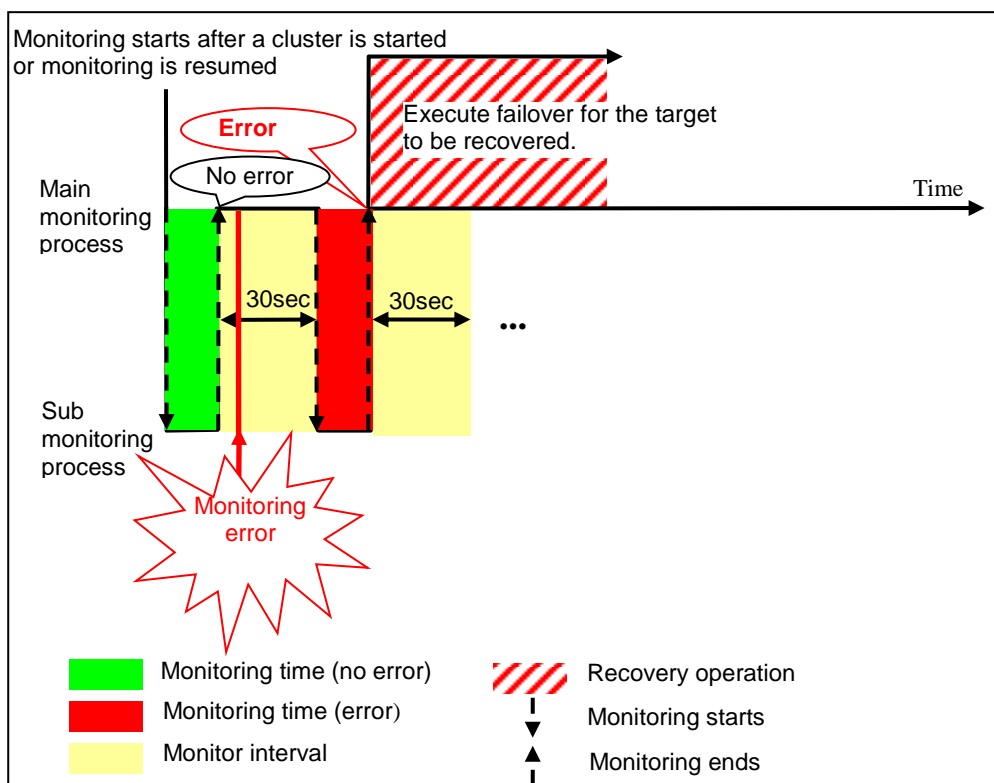

When an error occurs, it is detected at the next monitoring and the recovery operation for the recovery target starts.

When an error is detected (with monitor retry settings)

Examples of behavior when the following values are set:

<Monitor>

Monitor Interval 30 sec
 Monitor Timeout 60 sec
 Monitor Retry Count 2 times

<Error detection>

Recovery Target group
 Recovery Script Execution Count 0 time
 Reactivation Threshold 0 time
 Failover Threshold 1 time
 Final Action None

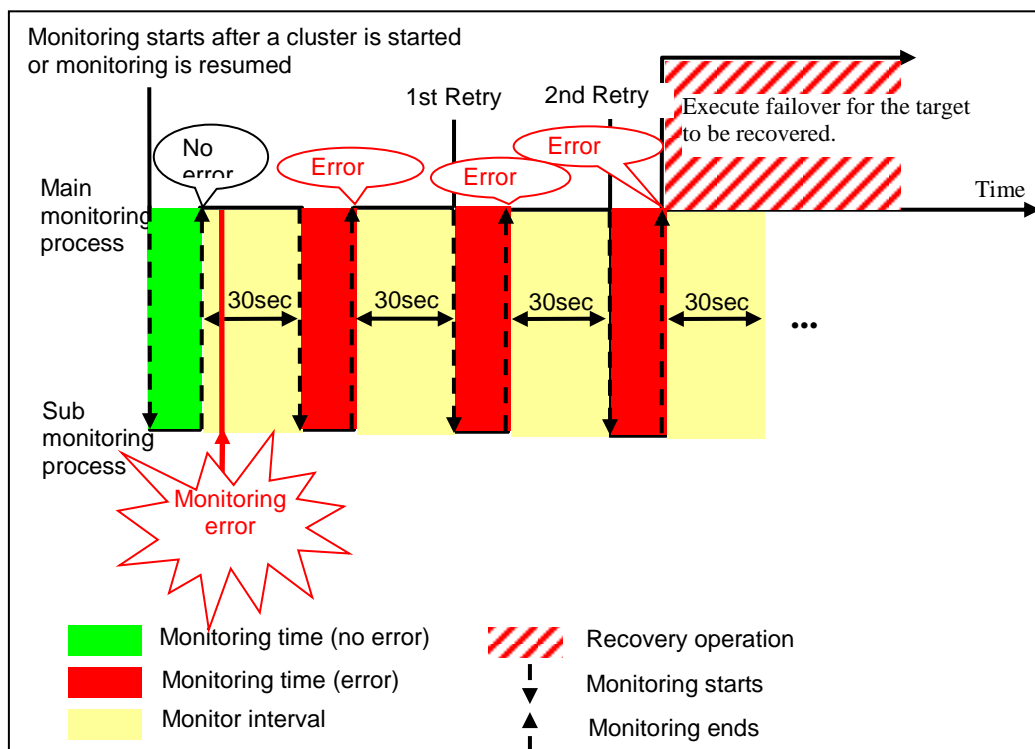

When an error occurs, it is detected at the next monitoring. If recovery cannot be achieved within the monitor retries, the failover is started for the recovery target.

When an error is detected (without monitor retry settings)

Examples of behavior when the following values are set.

<Monitor>
 Monitor Interval 30 sec
 Monitor Timeout 60 sec
 Monitor Retry Count 0 time

<Error detection>
 Recovery Target group
 Recovery Script Execution Count 0 time
 Reactivation Threshold 0 time
 Failover Threshold 1 time
 Final Action None

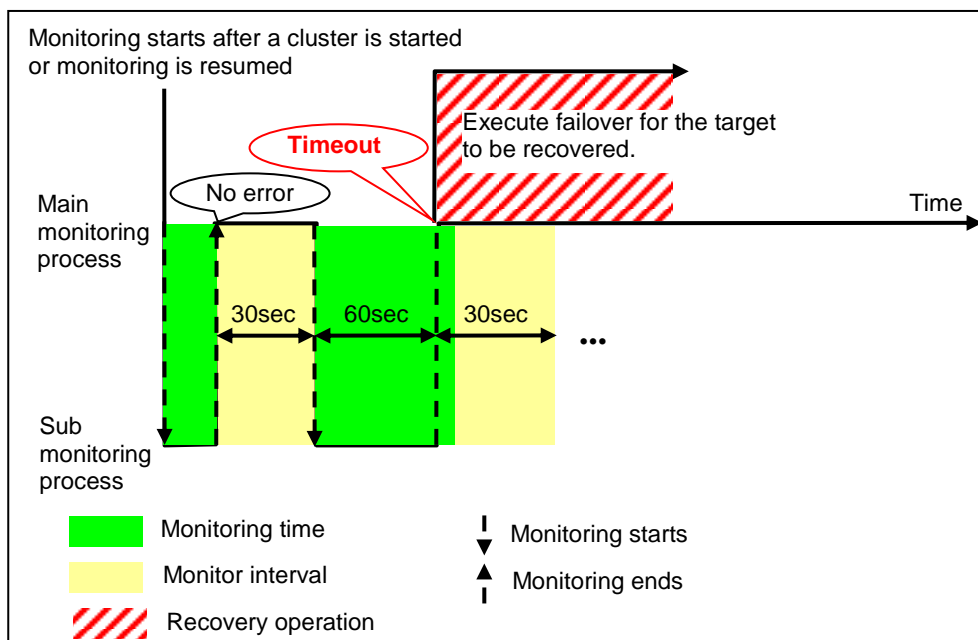

Immediately after an occurrence of a monitoring timeout, the failover for the recovery target starts.

When a monitoring timeout is detected (with monitor retry setting)

Examples of behavior when the following values are set:

<Monitor>
 Monitor Interval 30 sec
 Monitor Timeout 60 sec
 Monitor Retry Count 1 times

<Error detection>
 Recovery Target group
 Recovery Script Execution Count 0 time
 Reactivation Threshold 0 time
 Failover Threshold 1 time
 Final Action none

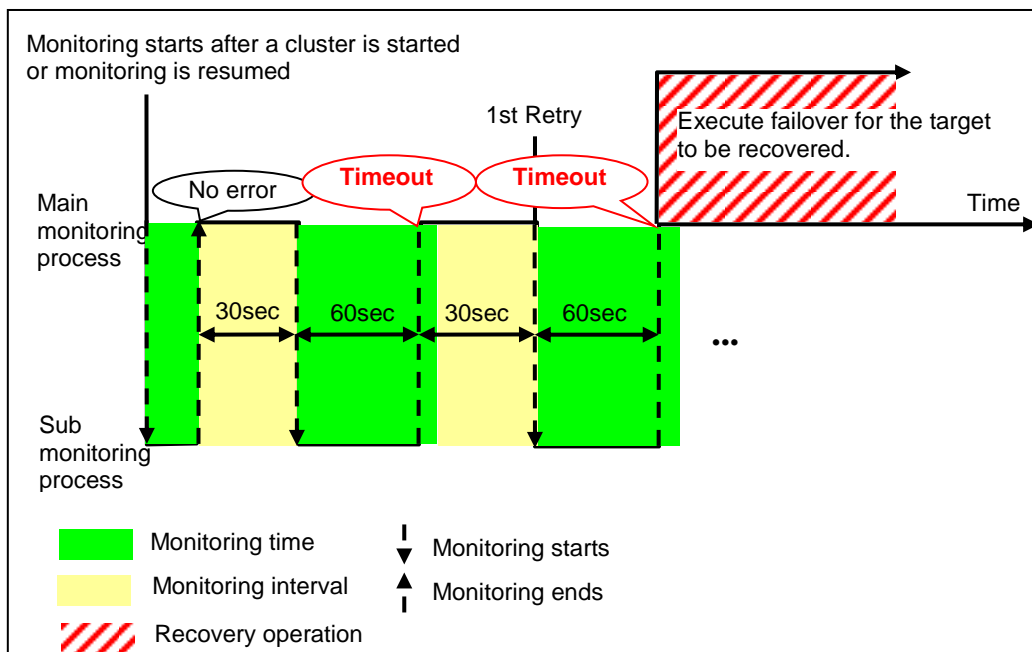

When a monitoring timeout occurs, monitor retry is performed and failover is started for the recovery target.

Behavior when an error is detected by a monitor resource

When an error is detected, the following recovery actions are taken against the recovery target in sequence:

- Execution of the recovery script: this takes place when an error is detected in a monitor target.
- Reactivation of the recovery target: this takes place if the recovery script is executed up to the recovery script execution count. When the execution of a pre-reactivation script is specified, reactivation starts after that script has been executed.
- Failover: this takes place when reactivation fails for the number of times set in the reactivation threshold. When the execution of a pre-failover script is specified, failover starts after that script has been executed.
- Final action: this takes place when the error is detected even after the failover is executed for the number of times set in the failover threshold (When the recovery target is the group resource or the failover group, the number of failover times is shared in the cluster. When the recovery target is All Groups, the number of failover times is counted by each server.). When the execution of a pre-final action script is specified, the final action starts after that script has been executed.

No recovery action is taken if the status of the recovery target is:

Recovery target	Status	Reactivation ³	Failover ⁴	Final action ⁵
Group resource/ Failover group	Already stopped	No	No	No
	Being activated/stopped	No	No	No
	Already activated	Yes	Yes	Yes
	Error	Yes	Yes	Yes
Local Server	-	-	-	Yes

Note:

Do not operate the following by running commands or using the WebManager when a group resource (e.g. disk resource, application resource) is set as a recovery target in the settings of error detection for the monitor resource, and recovery is in progress (reactivation -> failover -> final action) after detection of an error:

- Stopping/suspending the cluster
- Starting/stopping/moving a group

If you perform the above-mentioned operations while recovery caused by detection of an error by a monitor resource is in progress, other group resources of the group with an error may not stop.

However, you can perform them when the final action is completed.

When the status of the monitor resource recovers (becomes normal) from error, the reactivation count, failover count, and if the final action is executed are reset. Note that when group resource or failover group is specified as recovery target, these counters are reset only when the status of all the monitor resources in which the same recovery targets are specified are normal.

An unsuccessful recovery action is also counted into reactivation count or failover count.

³ Effective only when the value for the reactivation threshold is set to 1 (one) or greater.

⁴ Effective only when the value for the failover threshold is set to 1 (one) or greater.

⁵ Effective only when an option other than **No Operation** is selected.

The following is an example of the progress when only one server detects an error while the gateway is specified as an IP address of the IP monitor resource:

Examples of behavior when the following values are set:

<Monitor>

Interval 30 sec
 Timeout 30 sec
 Retry Count 3 times

<Error detection>

Recovery Target Failover Group A
 Recovery Script Execution Count 3 times
 Reactivation Threshold 3 times
 Failover Threshold Set as much as the number of the servers
 (2 times in the following case)
 Final Action No Operation

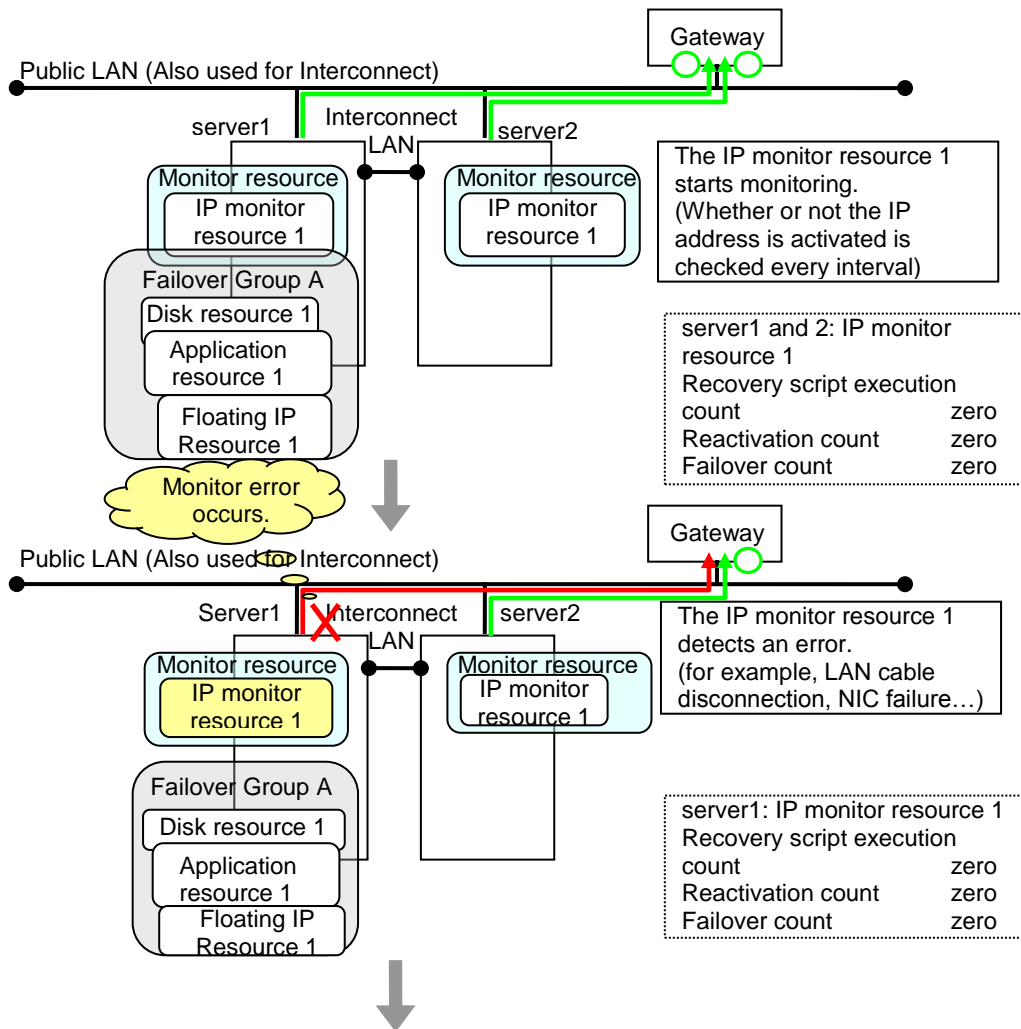

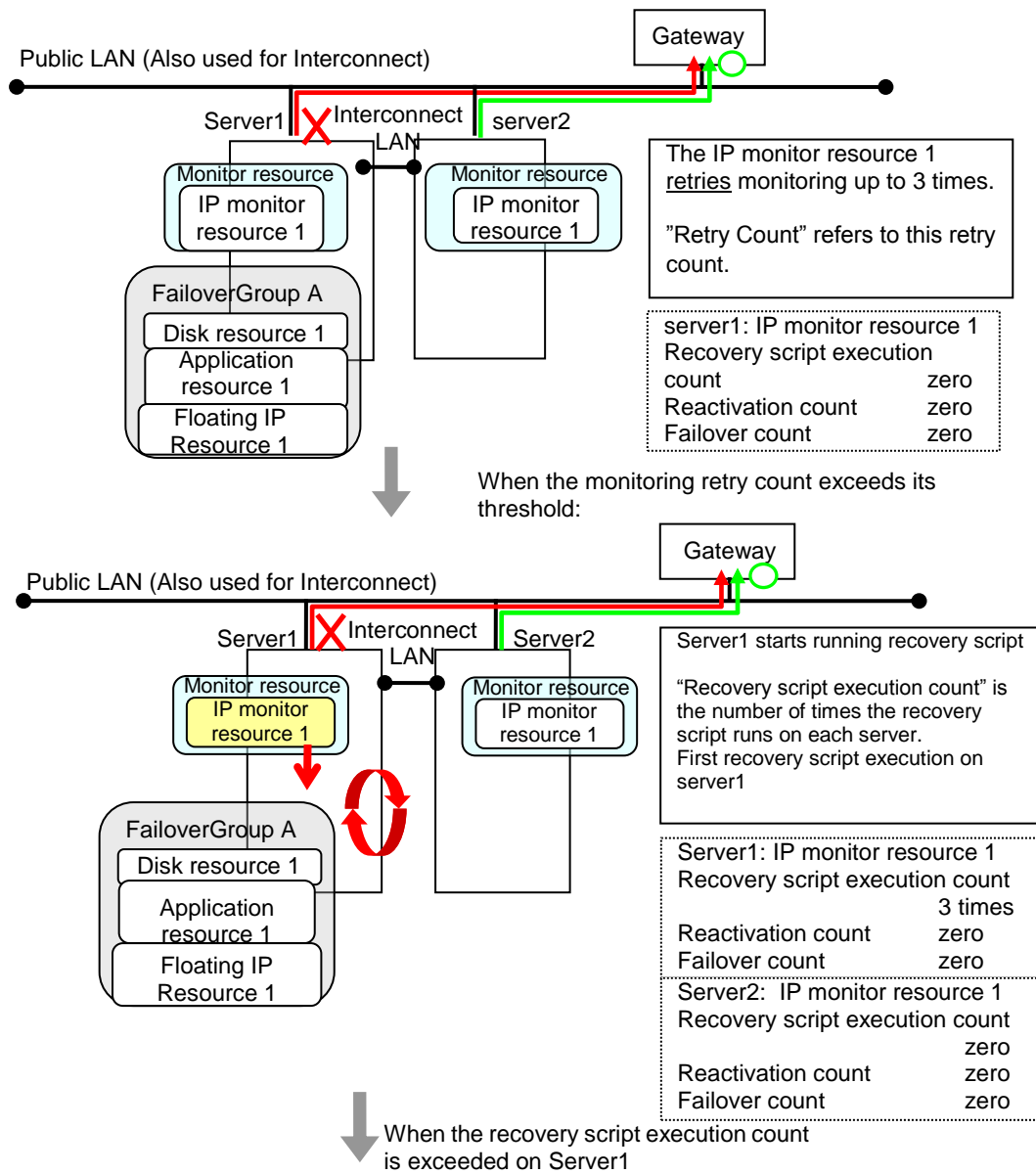

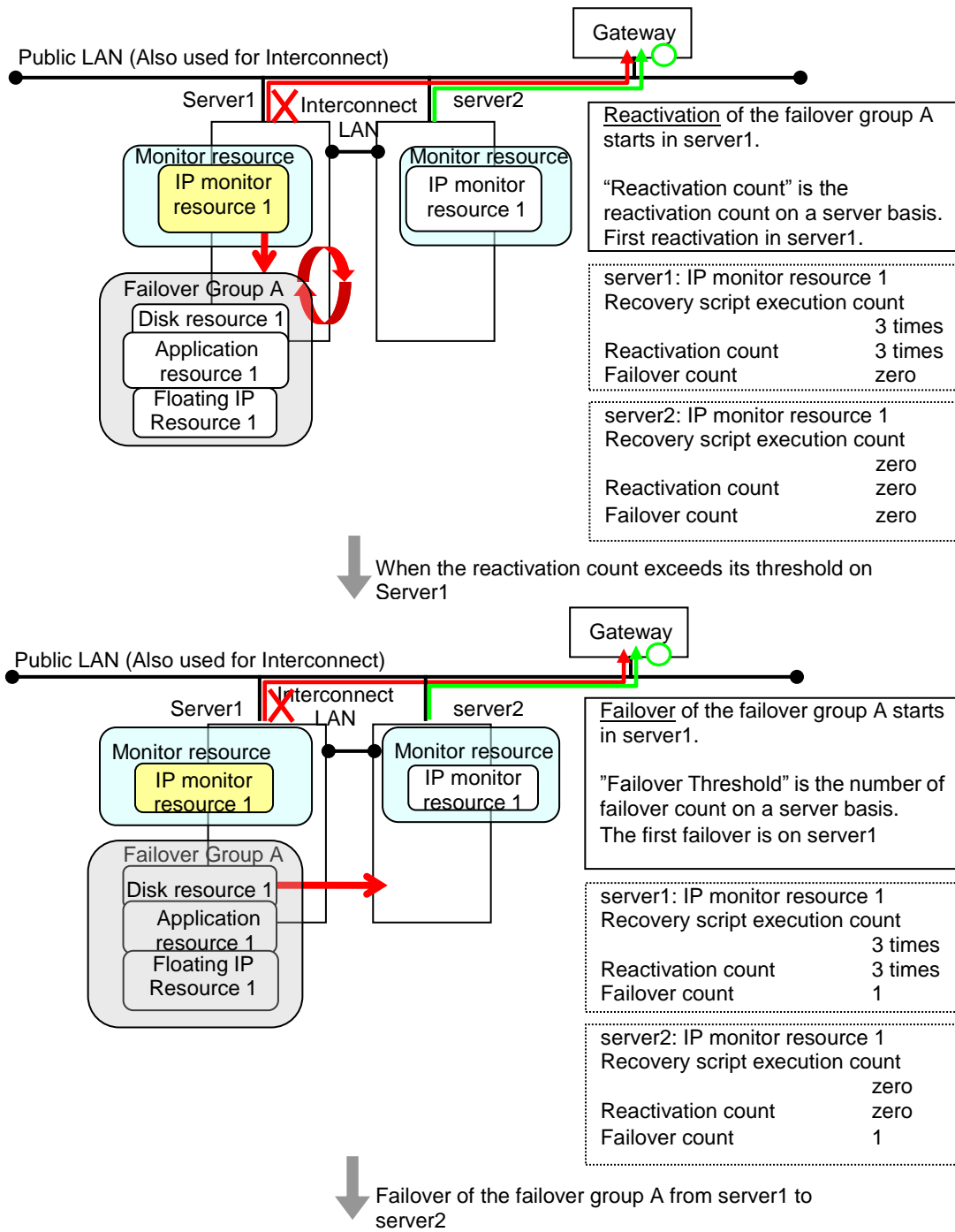

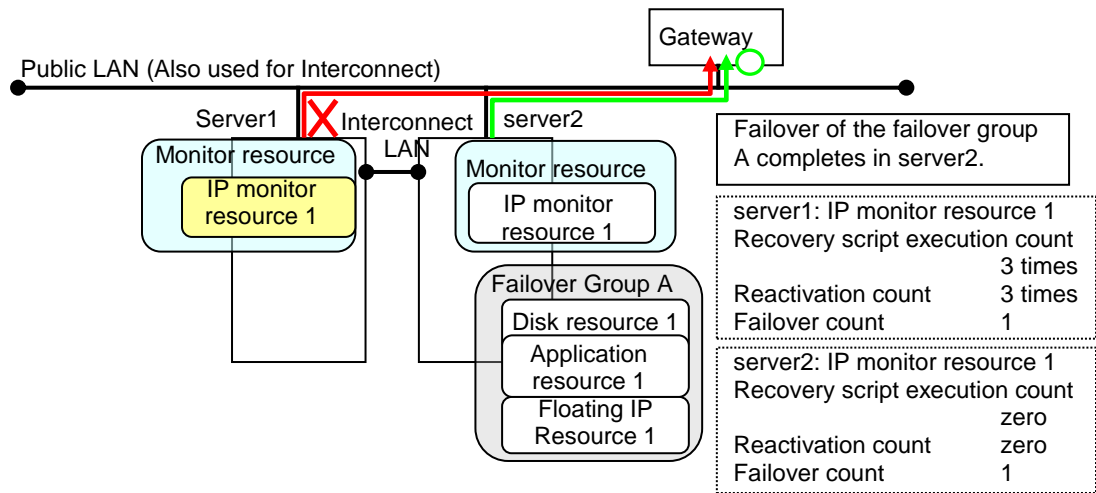

In server2, the operation can continue by failover of the Failover Group A because the IP monitor resource 1 is running properly.

The following is an example of the process when both servers detect an error while the gateway is specified as IP address of the IP monitor resource.

Examples of behavior when the following values are set.

<Monitor>

Interval 30 sec
 Timeout 30 sec
 Retry Count 3 times

<Error detection>

Recovery Target Failover Group A
 Recovery Script Execution Count 3 times
 Reactivation threshold 3 times
 Failover Threshold Set as much as the number of the servers
 (2 times in the following case)
 Final Action No Operation

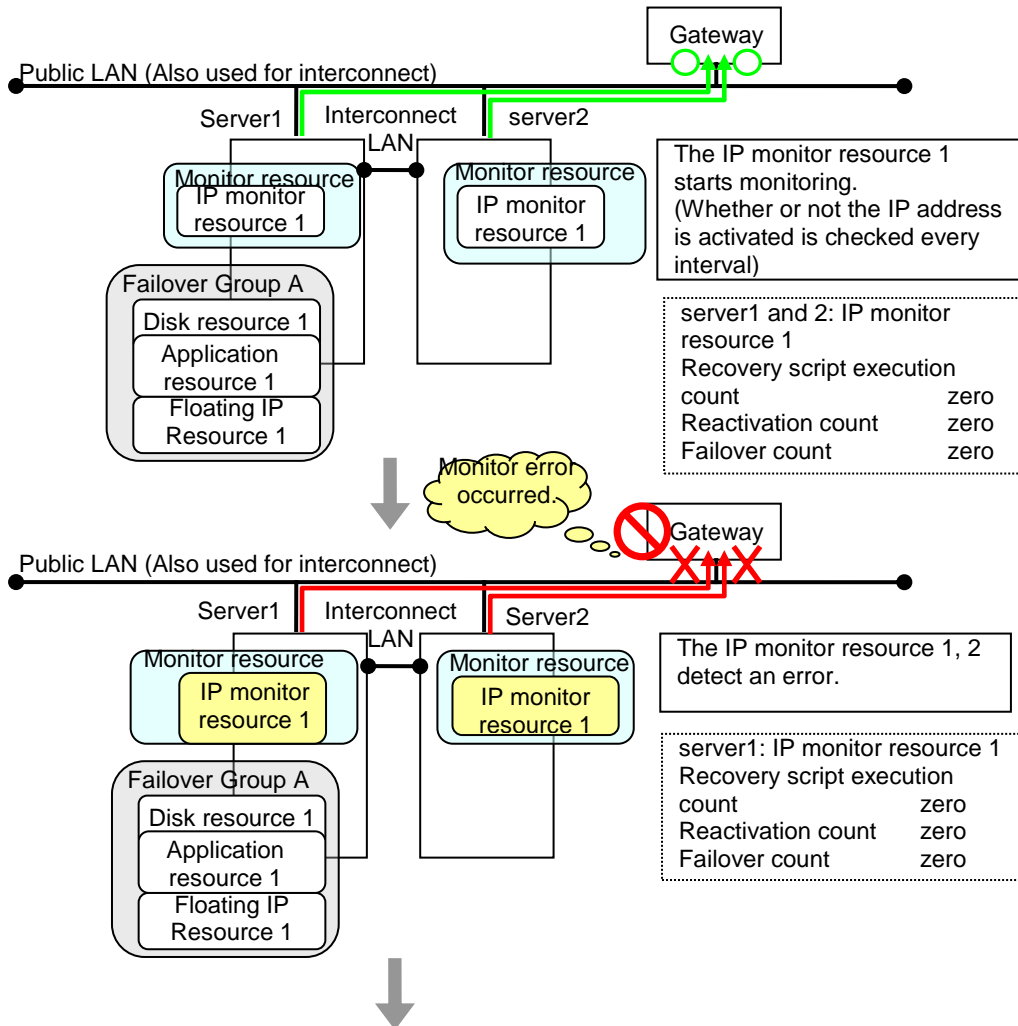

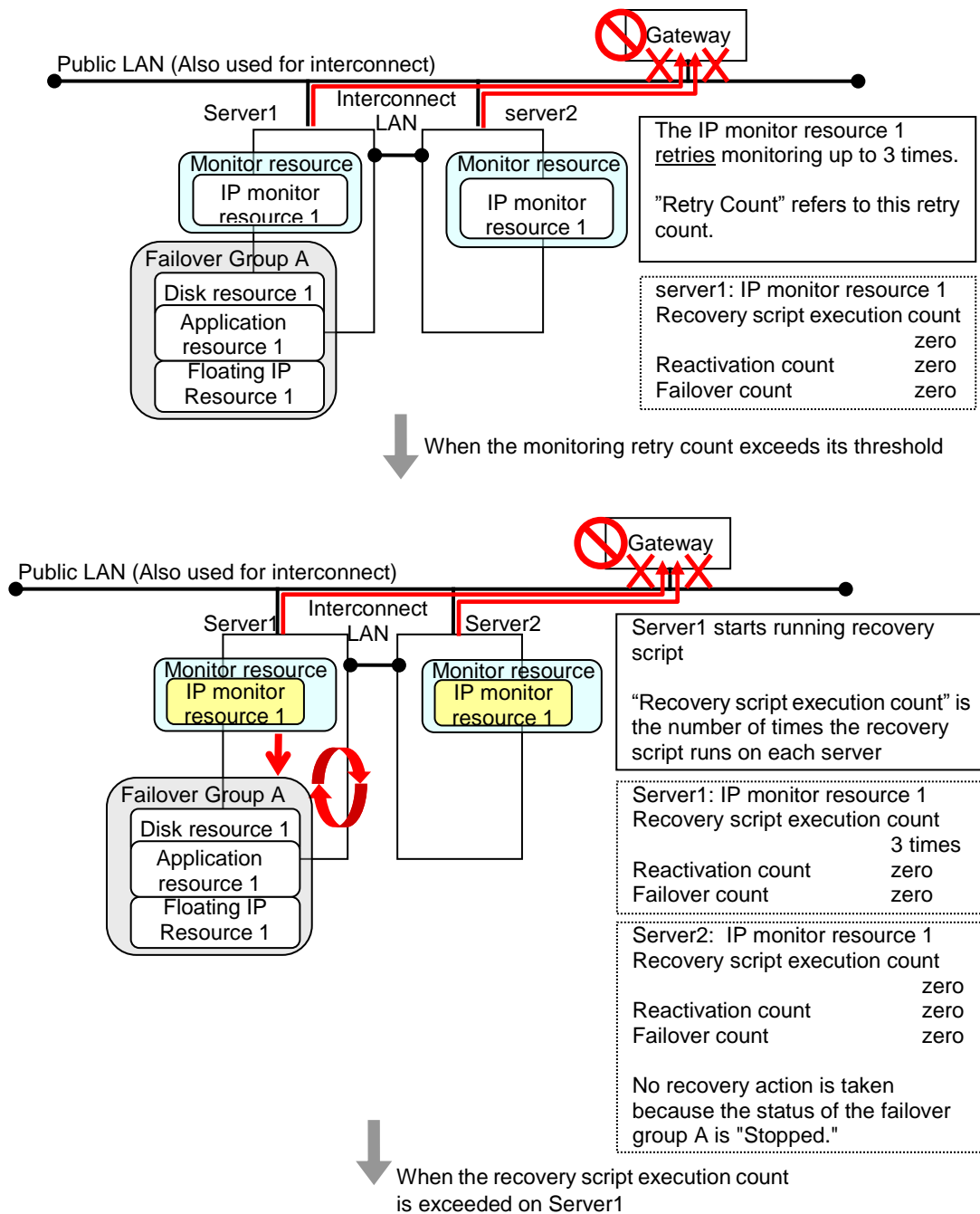

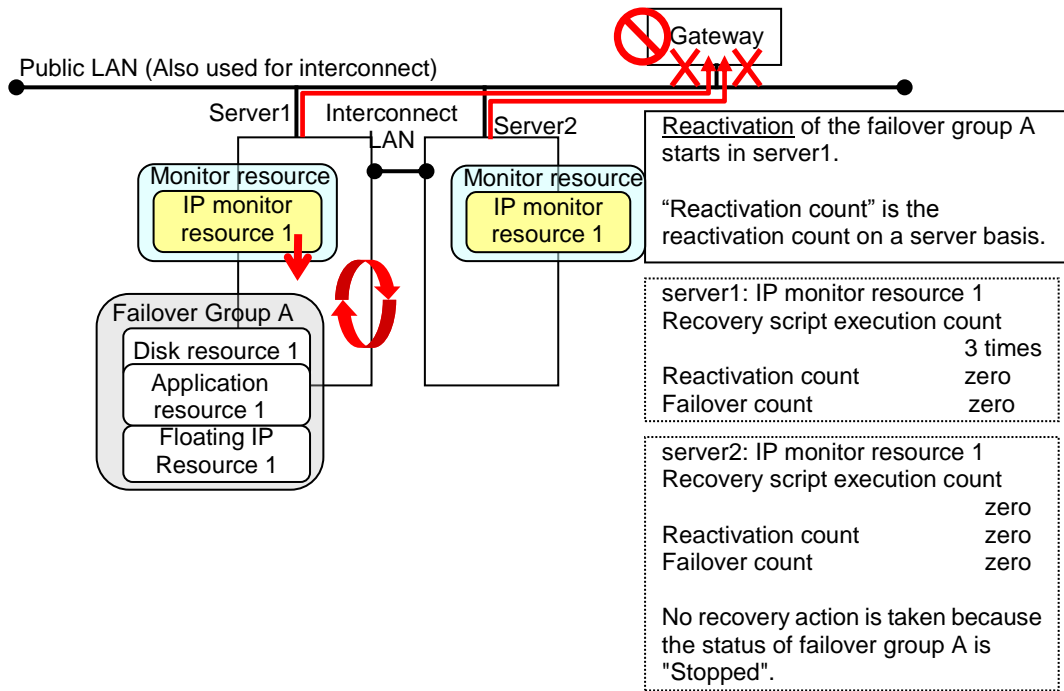

When reactivation count exceeds the threshold in server1

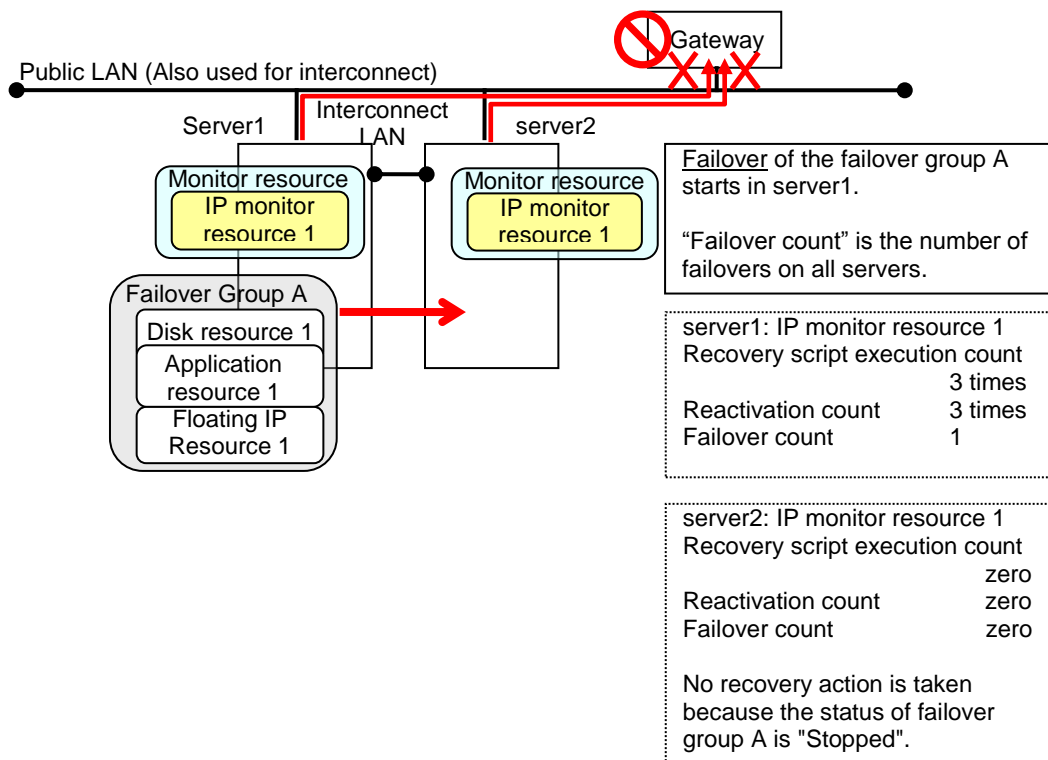

Failover the failover group A from server1 to server2

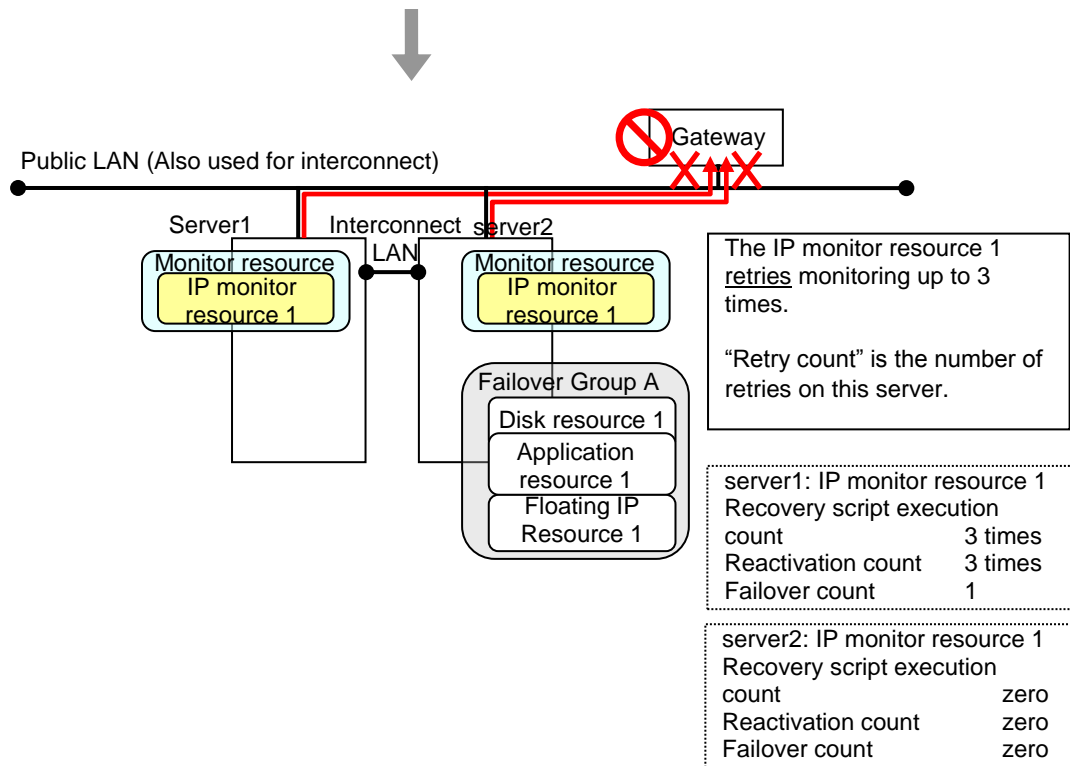
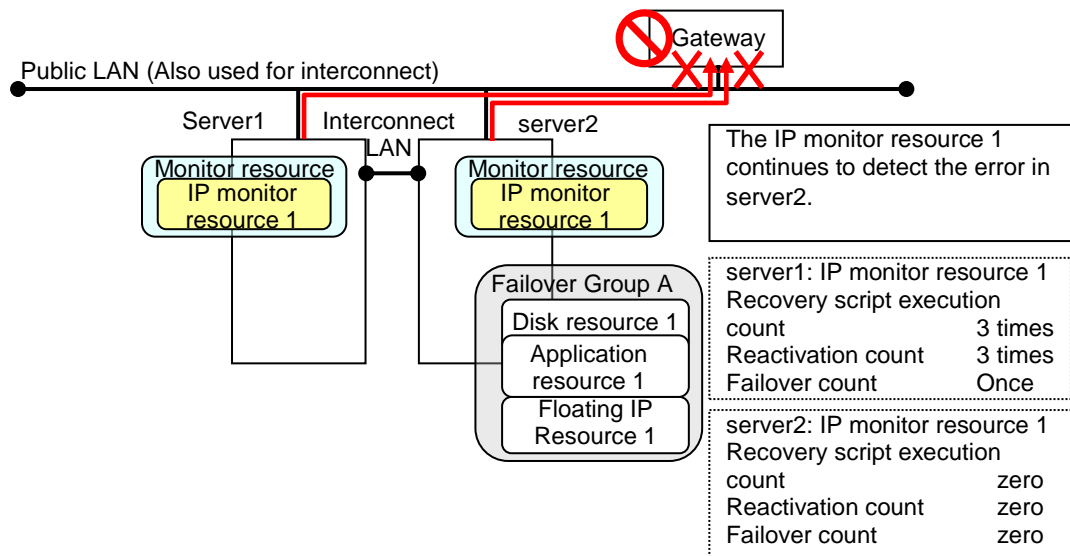

When the monitoring retry count exceeds its threshold

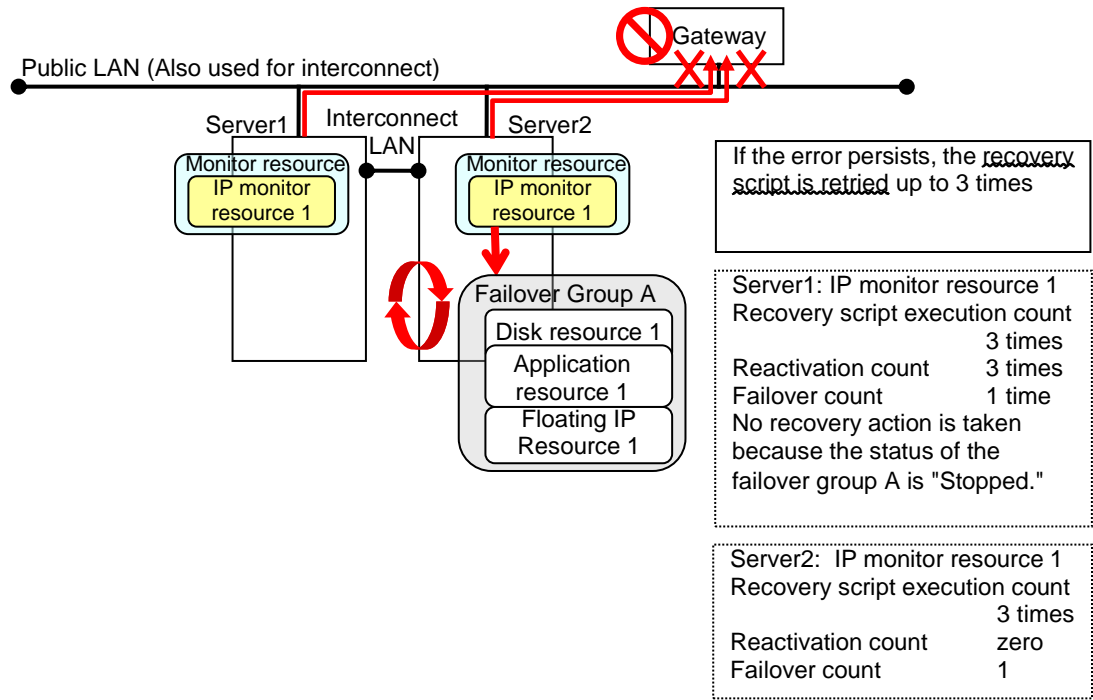

↓ When server2 also fails to retry running of the recovery script

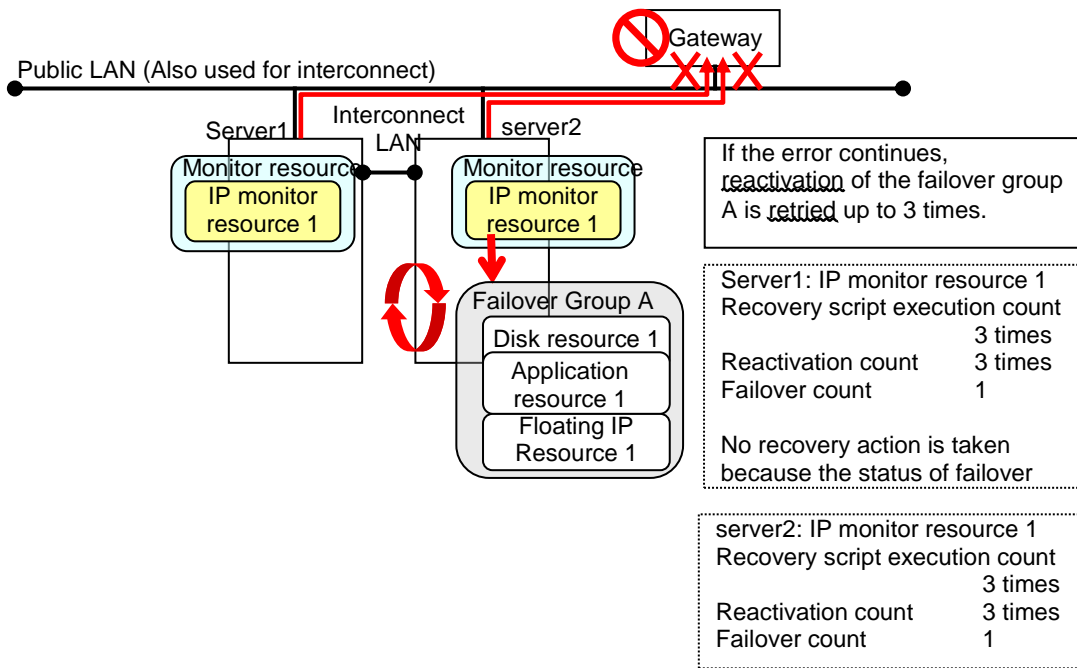

↓ When reactivation count also exceeds its threshold in server2

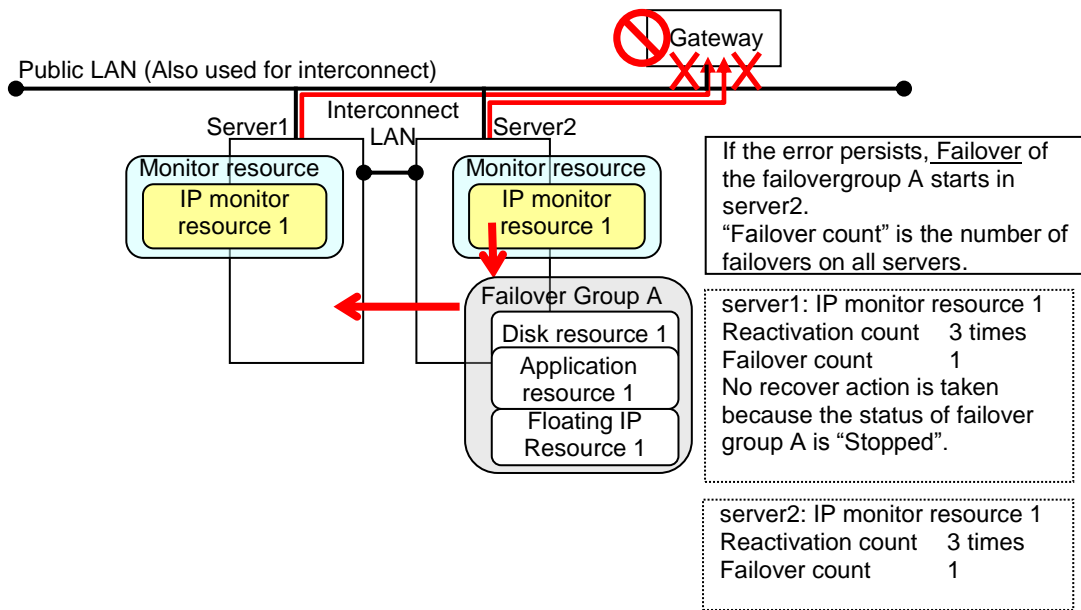

Failover the failover group A from server2 to server1

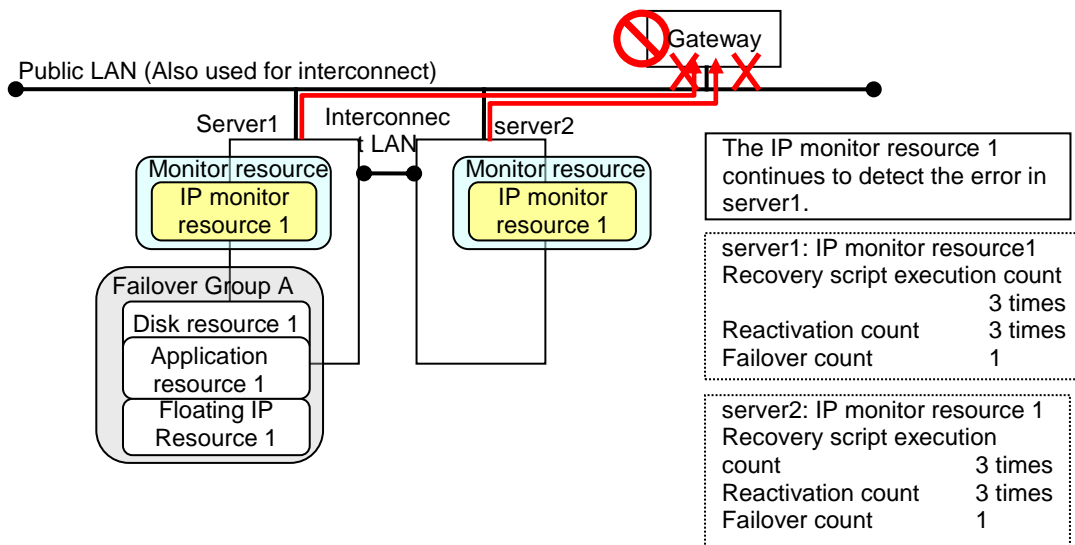

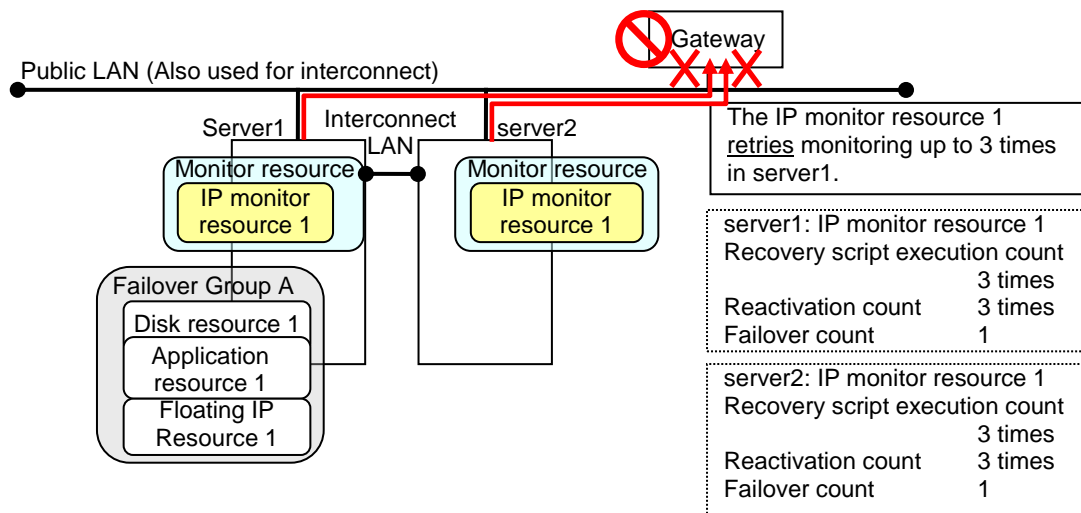

↓ When the monitoring retry count of IP monitor resource 1 exceeds its threshold again in server1:
 No reactivation is attempted because the reactivation threshold is 3.
 No failover is attempted because the failover threshold is 1.
 The final action starts.

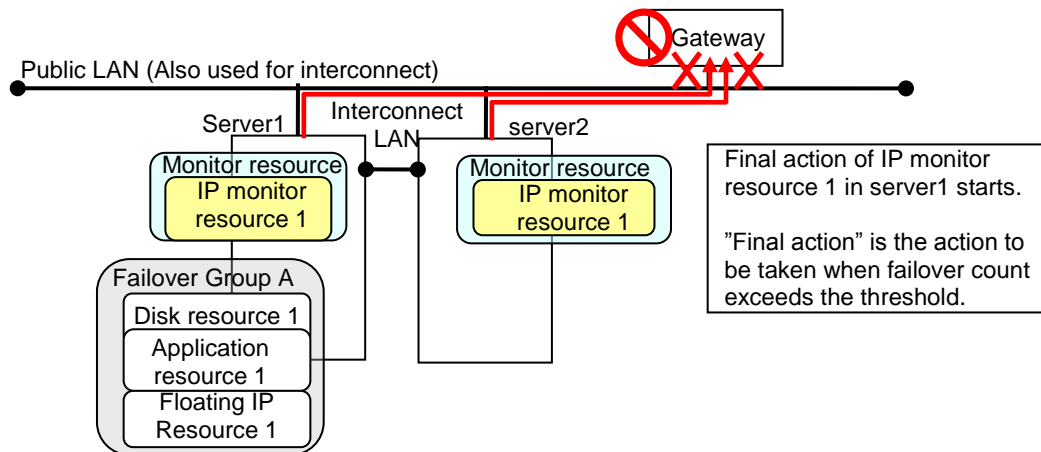

Additional Information

When the status of the monitor resource becomes normal from an error, the reactivation count and failover count are reset to zero (0).

Returning from monitor error (Normal)

When return of the monitor resource is detected during or after recovery actions following the detection of a monitoring error, counts for the following thresholds that the monitor resource keeps are reset. Note that when a group resource or failover group is specified as recovery target, these counters are reset only when the status of all the monitor resources in which the same recovery targets are specified become normal.

- Reactivation Threshold
- Failover Threshold

Whether or not to execute the final action is reset, (execution required).

The following pages describe what will be executed from the point when the final action as described in "Behavior when an error is detected by a monitor resource" on page 755 is executed and another monitoring error occurs after monitoring returns to normal.

Examples of behavior when the following values are set.

Configuration

<Monitor>

Interval	30 sec
Timeout	30 sec
Retry Count	3 times

<Error detection>

Recovery Target	Failover Group A
Recovery Script Execution Count	3 times
Reactivation Threshold	3 times
Failover Threshold	Set as much as the number of the servers (2 times in the following case)
Final Action	No operation

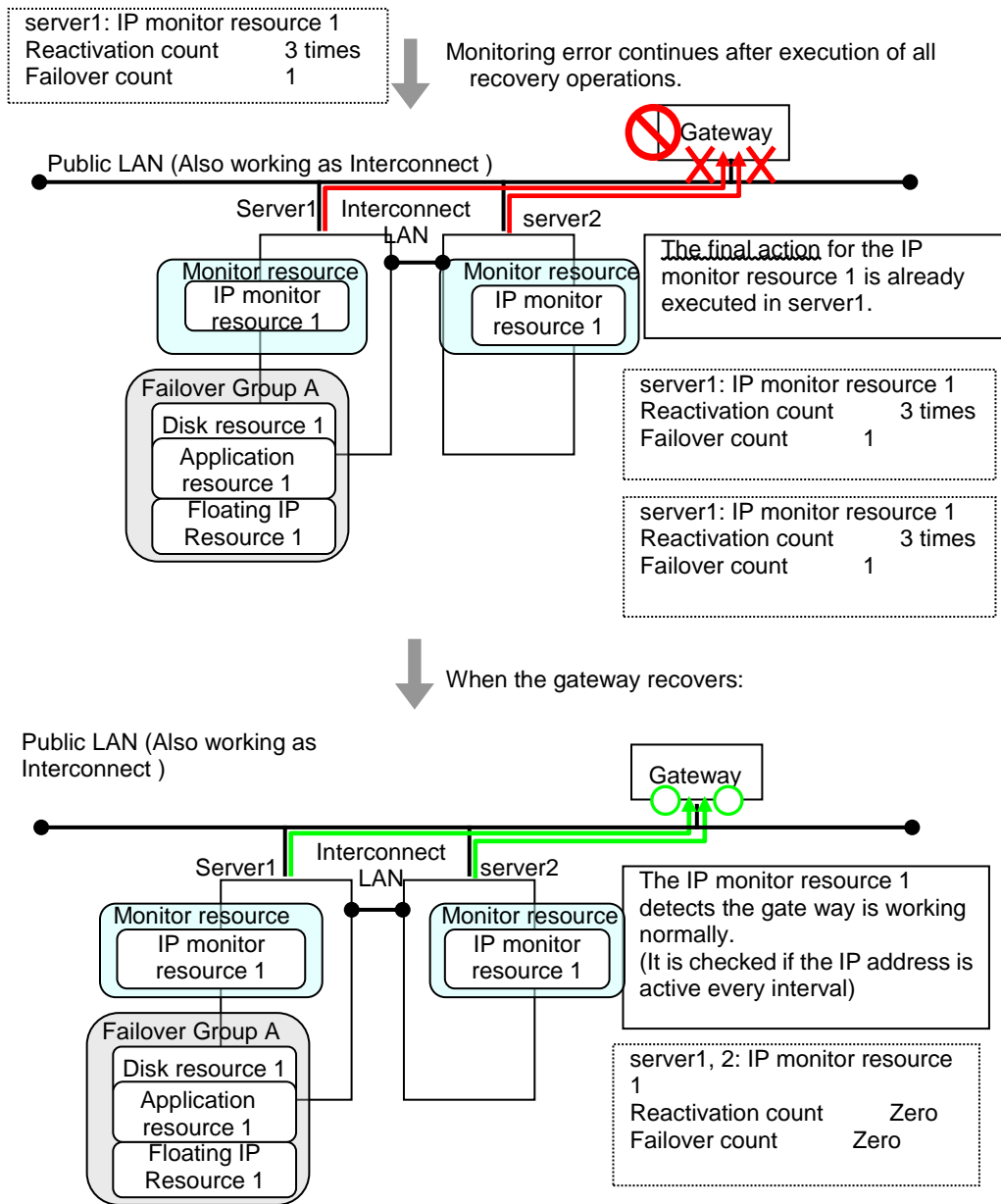

The number of reactivations and failovers are reset because it has been detected that the status of the monitor target resource became normal.

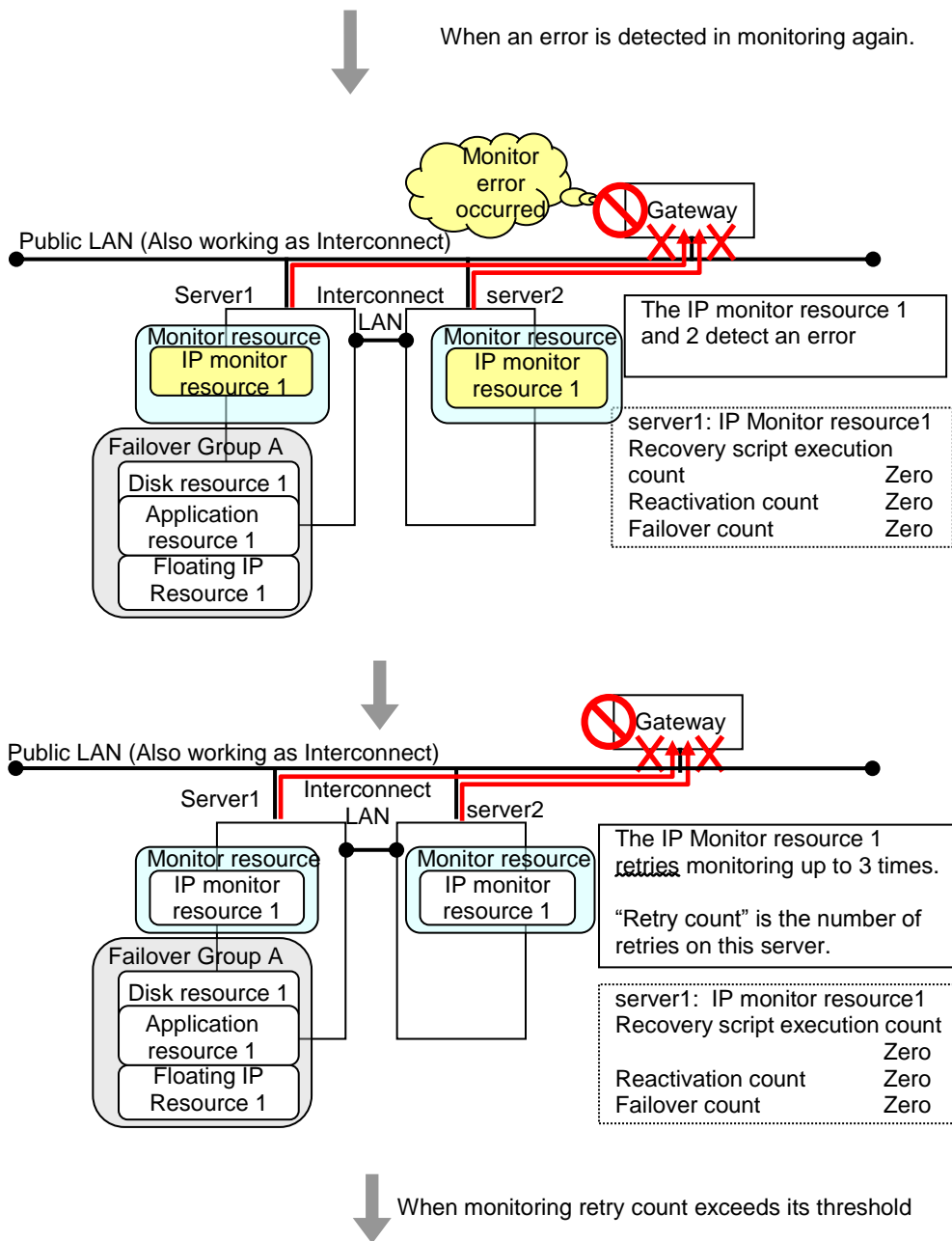

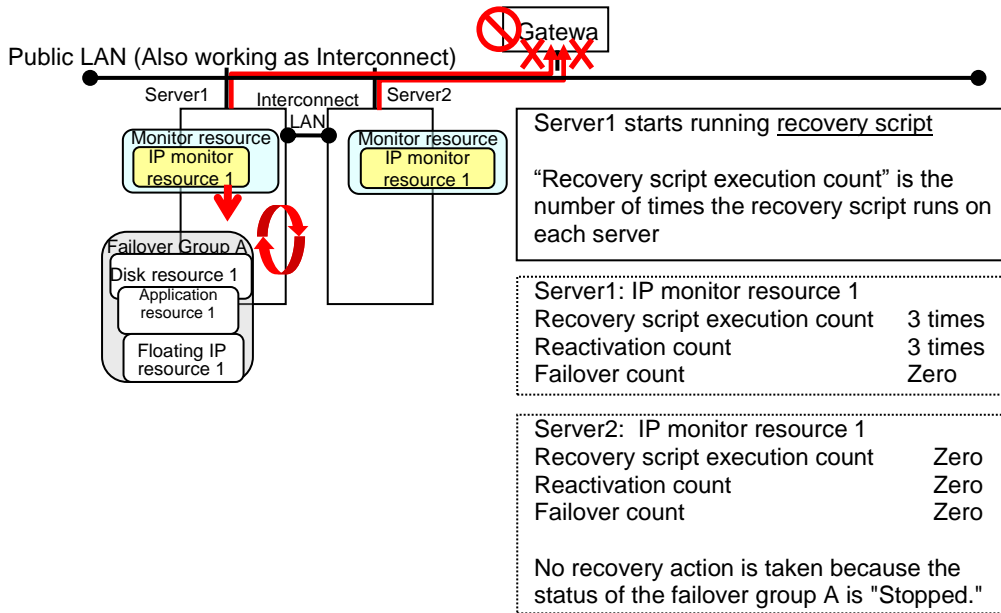

When the reactivation threshold is exceeded on Server1, failover group A is failed over

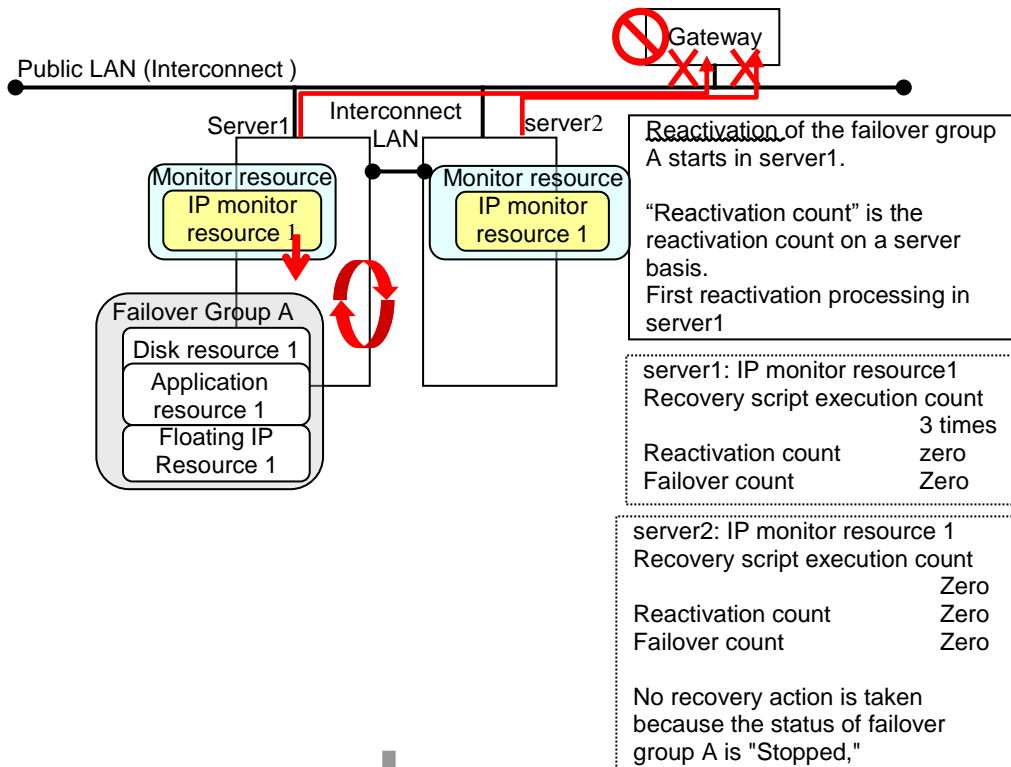

When reactivation count exceeds the threshold on server1, failover of the failover group A takes place

Reactivation is executed again because it has been detected that the status of the monitor target resource became normal and reactivation count has been reset before.

Activation and deactivation error of recovery target when executing recovery operation

When the monitoring target of the monitor resource is the device used for the group resource of the recovery target, an activation/deactivation error of the group resource may be detected during recovery when a monitoring error is detected.

The following is an example of the recovery progress when the same device is specified as the monitor target of the TUR monitor resource and the disk resource of the Failover Group A:

Configuration of the TUR monitor resource

<Monitor>

Interval	60 seconds
Timeout	120 seconds
Retry Count	Zero

<Error detection>

Recovery Target	Failover Group A
Recovery Script Execution Count	Zero
Reactivation Threshold	Zero
Failover Threshold	Set as much as the number of the servers (2 times in the following case)
Final Action	Stop Failover Group

Configuration of the failover group A: disk resource

<Activation error>

Activation retry Threshold	Zero
Failover Threshold	Set as much as the number of the servers (2 times in the following case)
Final Action	No Operation (Next resources are not activated)

<Deactivation abnormality>

Deactivation Retry Threshold	Zero
Final Action	Stop cluster service and shutdown OS

The reactivation threshold of the monitor resource and the activation retry threshold of the group resource are not mentioned in the following diagrams because they are set to zero (0).

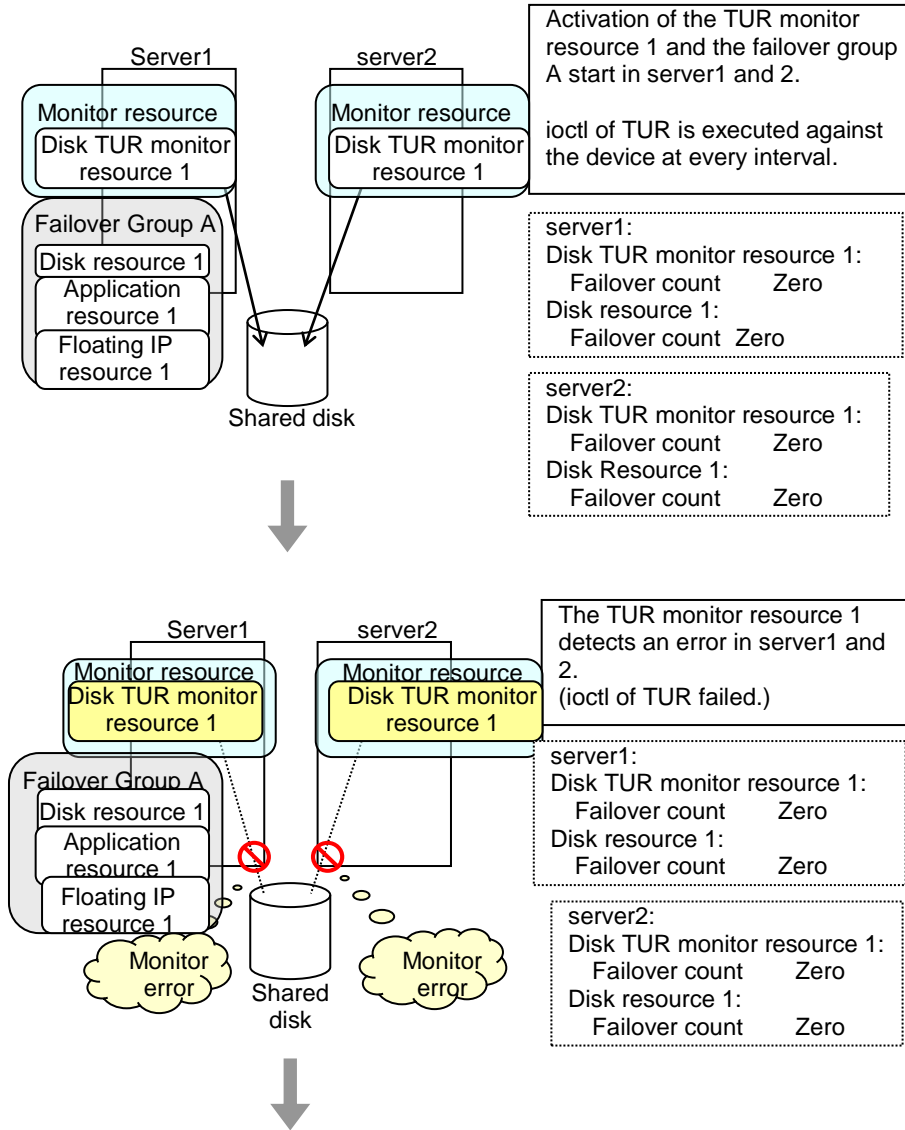

An error can be detected in deactivation of the disk resource depending on the location of the disk device failure.

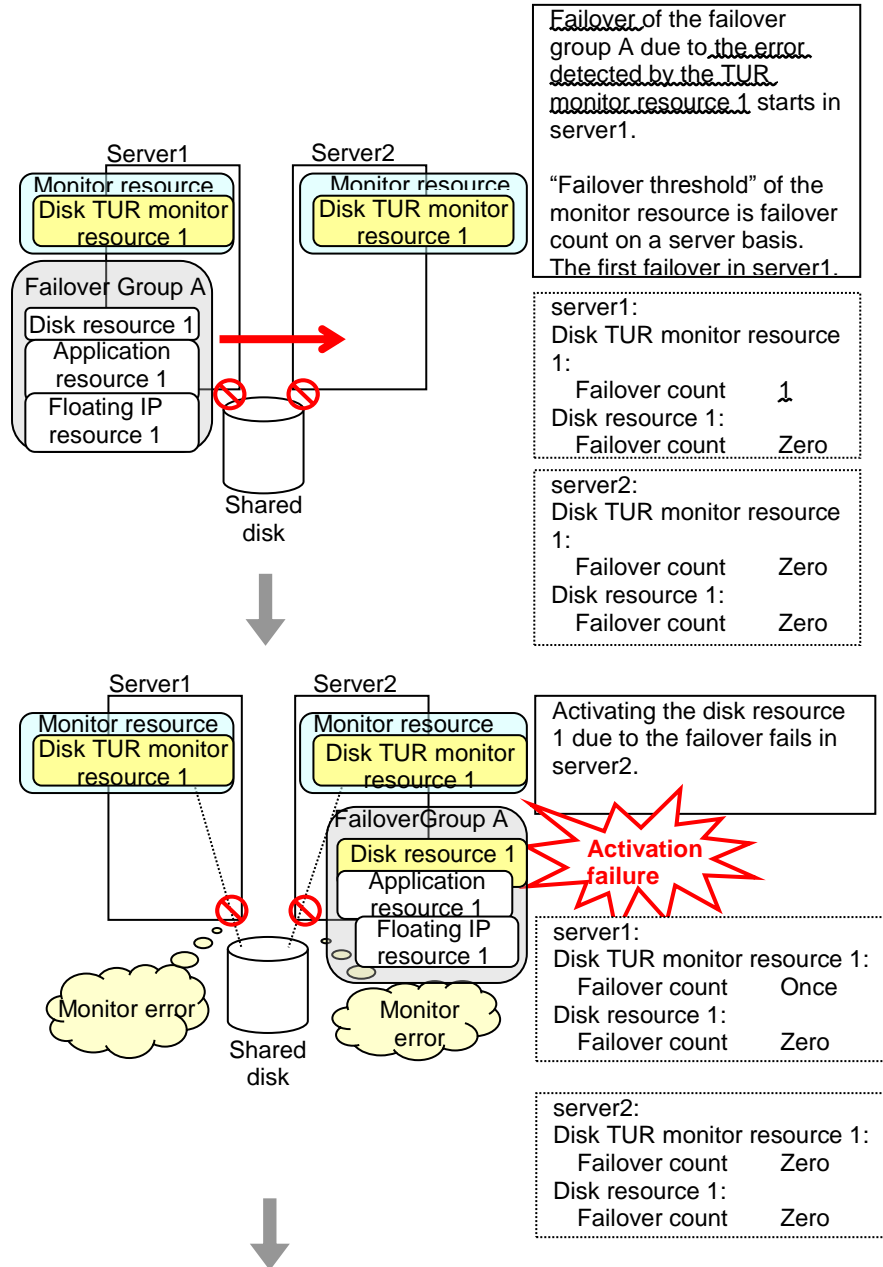

An error can be detected in deactivation of the disk resource depending on the location of the disk device failure.

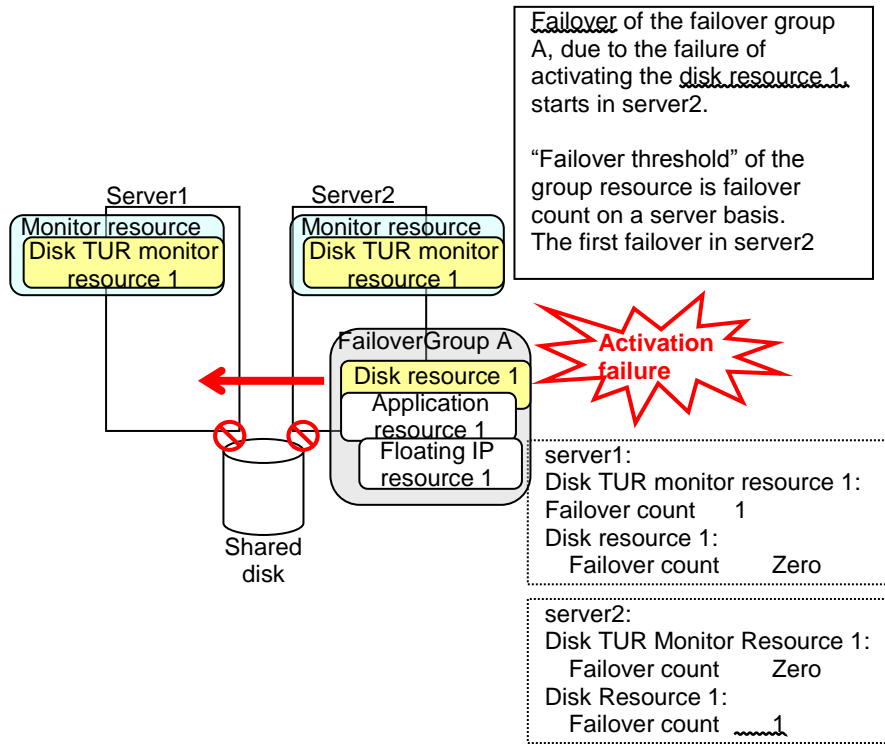

The TUR monitor resource 1 detects an error in server2 as is the case in server1. However, no recovery action is taken because the failover group A, the recovery target, is activated.

For more information on recovery executed by monitor resources against their recovery targets, see “Behavior when an error is detected by a monitor resource” on page 755

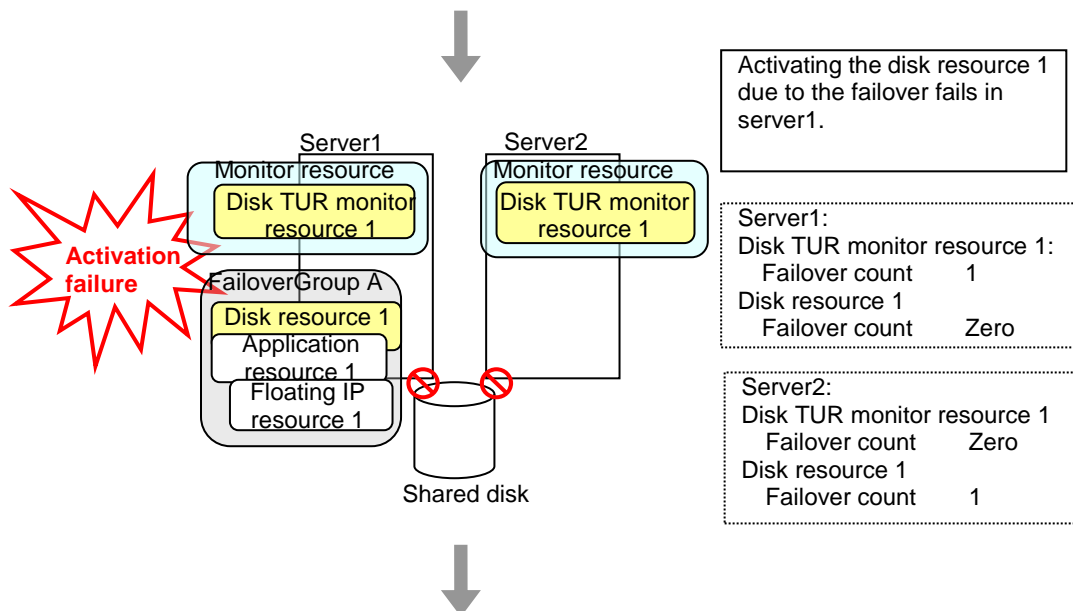

An error can be detected in deactivation of the disk resource depending on the location of the disk device failure.

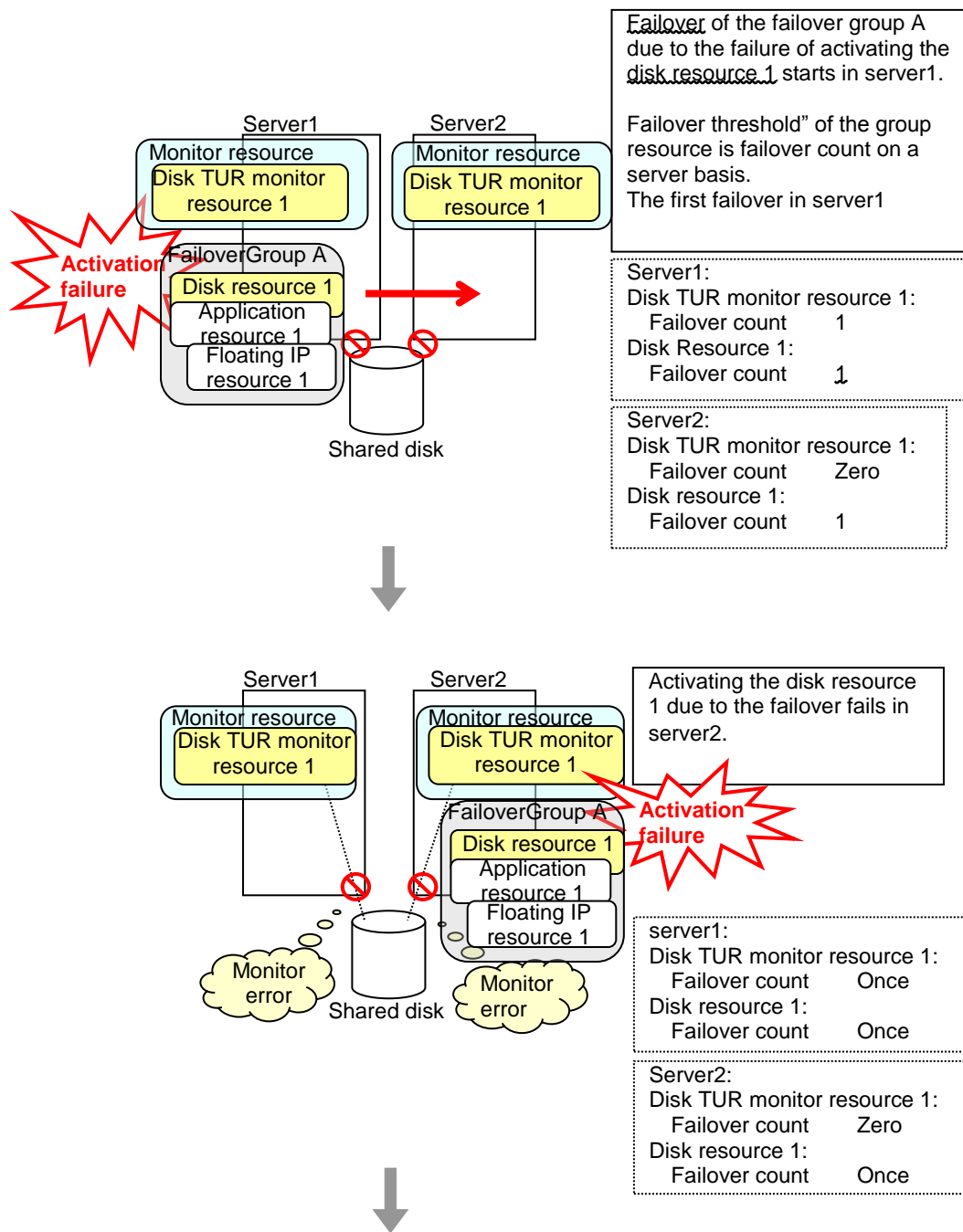

An error can be detected in deactivation of the disk resource depending on the location of the disk device failure.

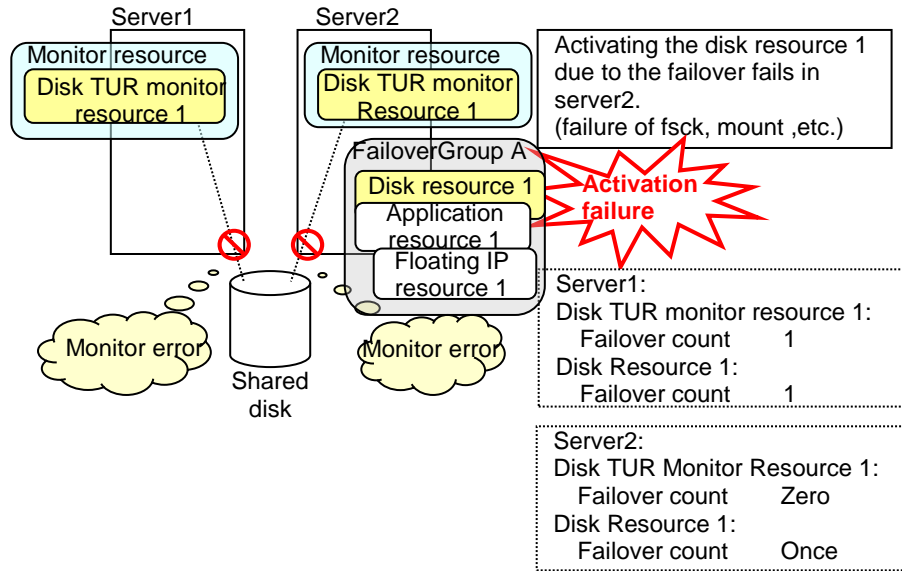

The final action is executed in server2 because the number of failovers due to failure of disk resource activation has exceeded its threshold.

However, note that activation ends abnormally without activating the rest of the group resources in the Failover Group A because “No operation (Next resources are not activated)” is selected as the final action.

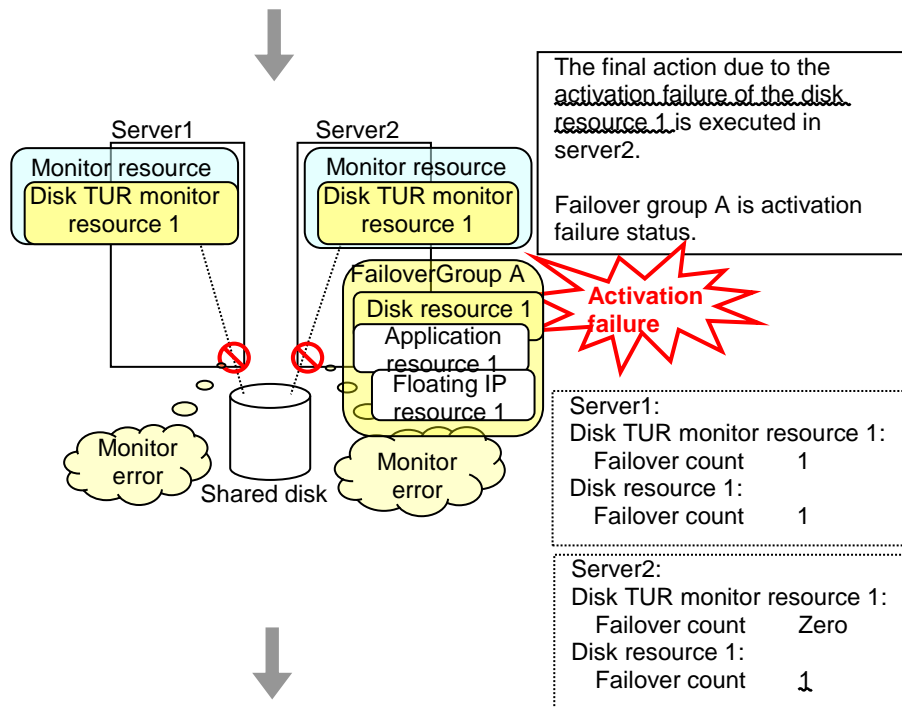

An error can be detected in deactivation of the disk resource depending on the location of the disk device failure.

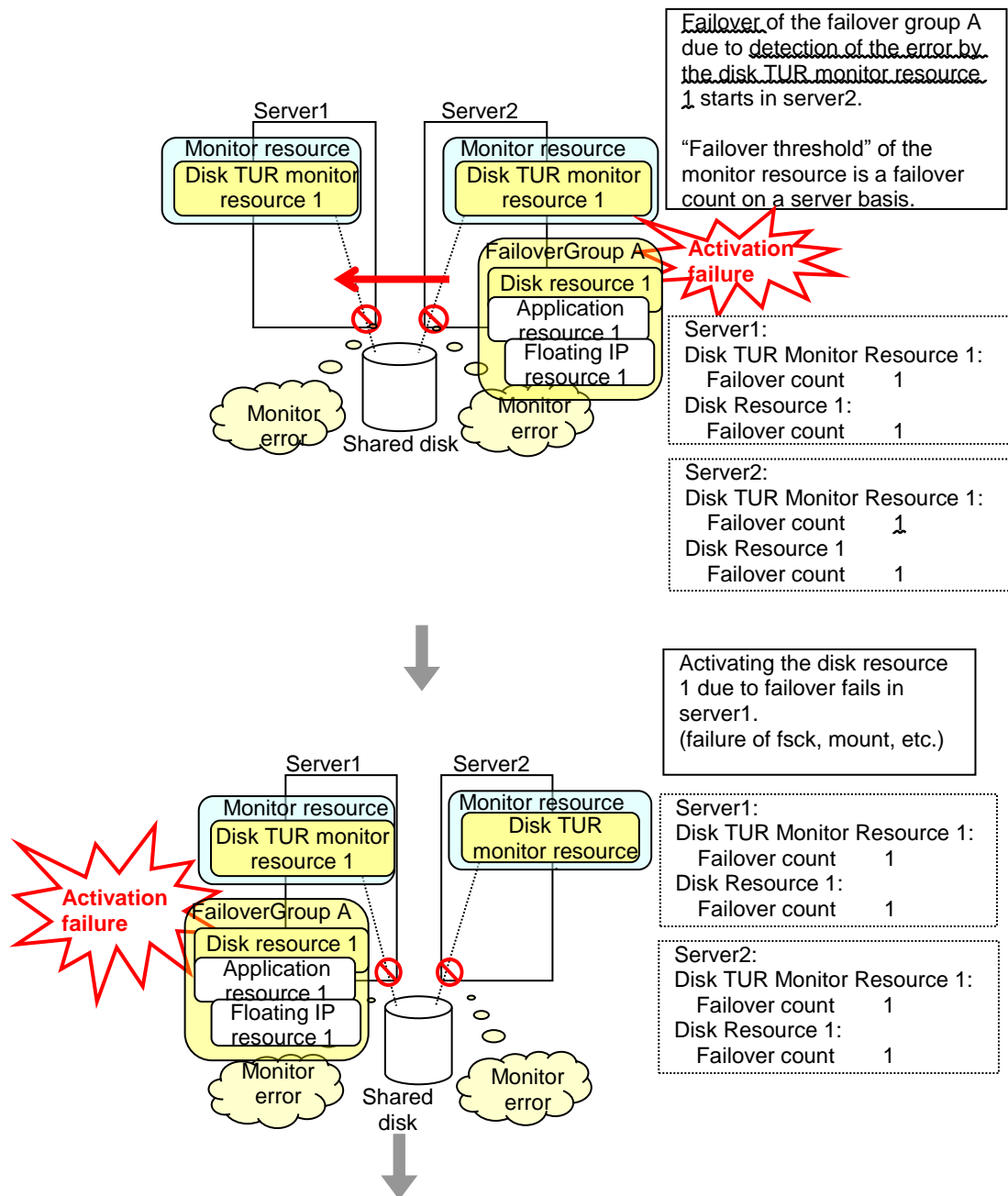

The final action is executed in server1 as is the case in server2 because the number of failovers due to failure of activating the disk resource 1 has exceeded the threshold.

However, note that activation ends abnormally without activating the rest of the group resources in the Failover Group A because “No operation (Next resources are not activated)” is selected as the final action.

An error can be detected in deactivation of the disk resource depending on the location of the disk device failure.

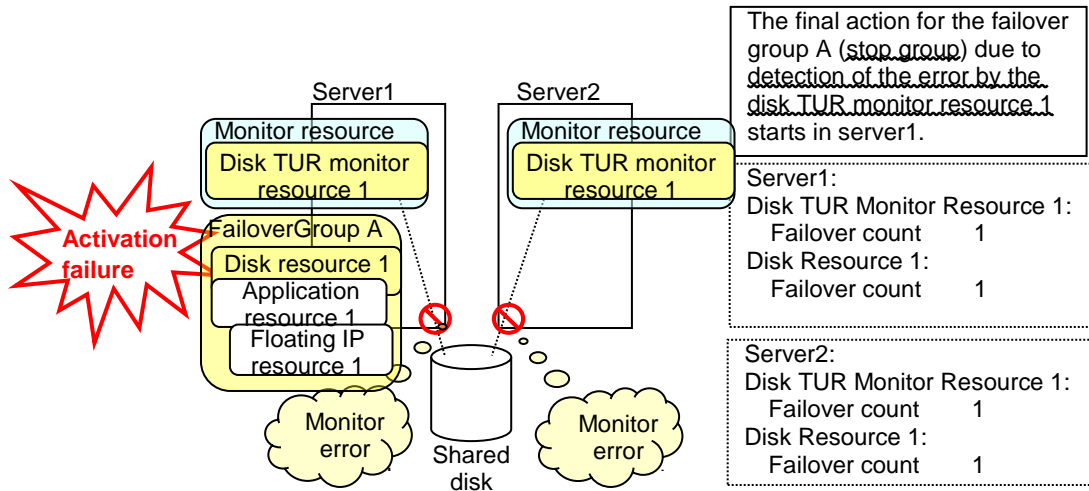

The final action is executed in server1 because the number of failovers due to monitoring error detected by the disk TUR monitor resource 1 has exceeded the threshold.

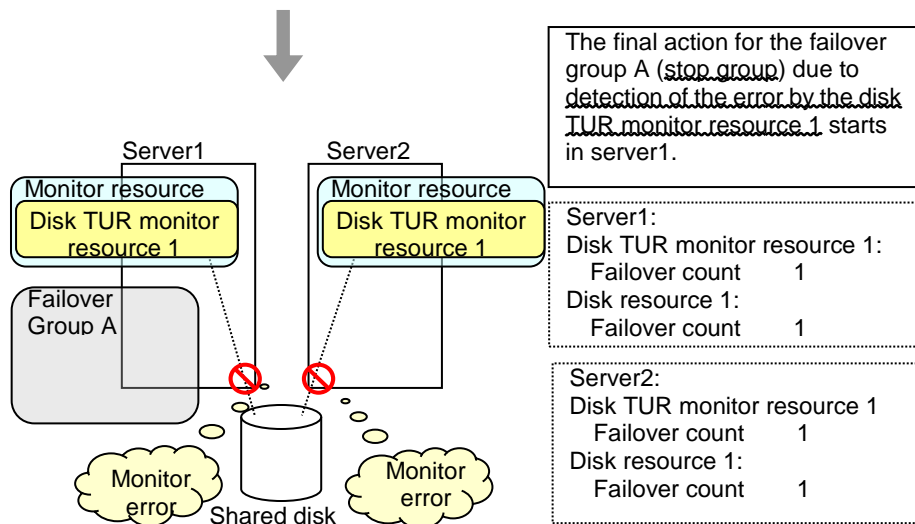

After the Failover Group A is stopped due to the final action executed for the disk TUR monitor resource 1 in server1, nothing will happen even if an error is detected by the disk TUR monitor resource 1.

However, note that the final action for the disk TUR monitor resource 1 is executed in server2 if the Failover Group A is manually activated because the final action for the disk monitor TUR resource 1 is not executed yet.

Recovery/pre-recovery action script

Upon the detection of a monitor resource error, a recovery script can be configured to run. Alternatively, before the reactivation, failover, or final action of a recovery target, a pre-recovery action script can be configured to run.

The script is a common file.

Environment variables used in the recovery/pre-recovery action script

EXPRESSCLUSTER sets status information (the recovery action type) in the environment variables upon the execution of the script.

The script allows you to specify the following environment variables as branch conditions according to the operation of the system.

Environment variable	Value of the environment variable	Description
CLP_MONITORNAME ...Monitor resource name	Monitor resource name	Name of the monitor resource in which an error that causes the recovery/pre-recovery action script to run is detected.
CLP_VERSION_FULL ...EXPRESSCLUSTER full version	EXPRESSCLUSTER full version	Represents the EXPRESSCLUSTER full version. Example: 11.10
CLP_VERSION_MAJOR ...EXPRESSCLUSTER major version	EXPRESSCLUSTER major version	Represents the EXPRESSCLUSTER major version. Example: 11
CLP_PATH ...EXPRESSCLUSTER installation path	EXPRESSCLUSTER installation path	Represents the path where EXPRESSCLUSTER is installed. Example: C:\Program Files\EXPRESSCLUSTER
CLP_OSNAME ...Server OS name	Server OS name	Represents the OS name of the server where the script was executed. Example: Windows Server 2008 R2 Datacenter SP1
CLP_OSVER ...Server OS version	Server OS version	Represents the OS version of the server where the script was executed. Example: 6.1.1.0.128.3
CLP_ACTION ...Recovery action type	RECOVERY	Execution as a recovery script.
	RESTART	Execution before reactivation.
	FAILOVER	Execution before failover.
	FINALACTION	Execution before final action.
CLP_RECOVERYCOUNT ...Recovery script execution count	Recovery Script Execution Count	Count for recovery script execution.
CLP_RESTARTCOUNT ...Reactivation count	Reactivation count	Count for reactivation.

Environment variable	Value of the environment variable	Description
CLP_FAILOVERCOUNT ...Failover count	Failover count	Count for failover.

Writing recovery/pre-recovery action scripts

This section explains the environment variables mentioned above, using a practical scripting example.

Example of a recovery/pre-recovery action script

```
rem *****
rem *           preaction.bat           *
rem *****
echo START
IF "%CLP_ACTION%" == "" GOTO NO_CLP
IF "%CLP_ACTION%" == "RECOVERY" GOTO RECOVERY
IF "%CLP_ACTION%" == "RESTART" GOTO RESTART
IF "%CLP_ACTION%" == "FAILOVER" GOTO FAILOVER
IF "%CLP_ACTION%" == "FINALACTION" GOTO FINALACTION
GOTO NO_CLP
```

```
:RECOVERY
echo RECOVERY COUNT : %CLP_RECOVERYCOUNT%
```

```
Processing type:
    Recovery
Execution timing of the processing:
    Recovery action: Recovery script
```

```
GOTO EXIT
:RESTART
echo RESTART COUNT : %CLP_RESTARTCOUNT%
```

```
Processing type:
    Pre-reactivation processing
Execution timing of the processing:
    Recovery action: Reactivation
```

```
GOTO EXIT
:FAILOVER
echo RESTART COUNT : % CLP_FAILOVERCOUNT %
```

```
Processing type:
    Recovery
Execution timing of the processing:
    Recovery action: Failover
```

```
:FINALACTION
echo FINAL ACTION
```

```
Processing type:
    Recovery
Execution timing of the processing:
    Recovery action: Final action
```

```
GOTO EXIT
:NO_CLP
:EXIT
echo EXIT
```

Tips for recovery/pre-recovery action script coding

Pay careful attention to the following points when coding the script.

- When the script contains a command that requires a long time to run, log the end of execution of that command. The logged information can be used to identify the nature of the error if a problem occurs. `clplogcmd` is used to log the information.

Note on the recovery/pre-recovery action script

- Condition that a script before final action is executed
A script before final action is executed before the final action upon detection of a group resource activation or deactivation failure. Even if **No operation (Next Resources Are Activated/Deactivated)** or **No operation (Next Resources Are Not Activated/Deactivated)** is set as the final action, a script before final action is executed.
If the final action is not executed because the maximum restart count has reached the upper limit or by the function to suppress the final action when all other servers are being stopped, a script before final action is not executed.

Delay warning of monitor resources

When a server is heavily loaded, due to a reason such as applications running concurrently, a monitor resource may detect a monitoring timeout. It is possible to have settings to issue an alert at the time when the time for monitor processing (the actual elapsed time) reaches a certain percentages of the monitoring time before a timeout is detected.

The following figure shows timeline until a delay warning of the monitor resource is used.

In this example, the monitoring timeout is set to 60 seconds and the delay warning rate is set to 80%, which is the default value.

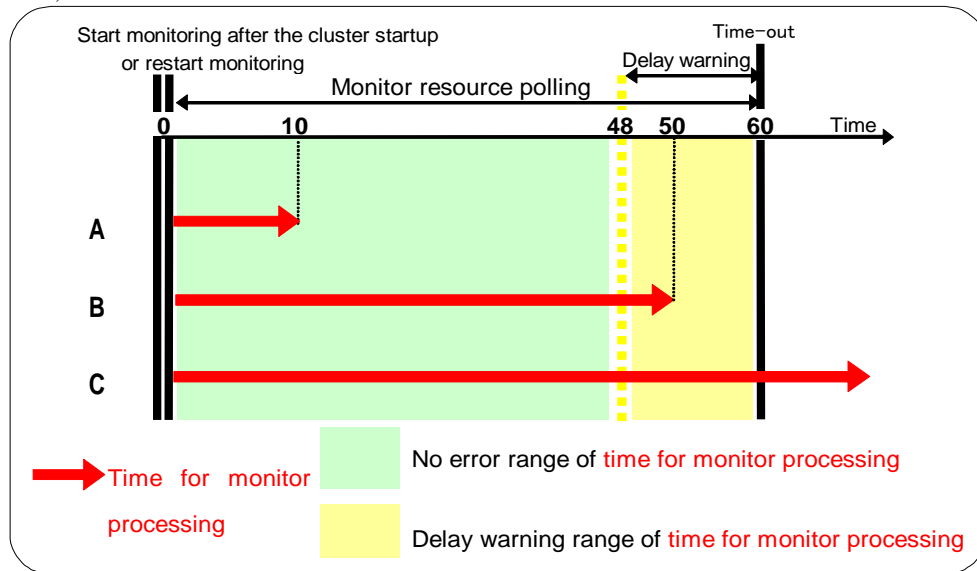

- A. The time for monitor processing is 10 seconds. The monitor resource is in normal status. In this case, no alert is used.
- B. The time for monitor processing is 50 seconds and the delay of monitoring is detected during this time. The monitor resource is in the normal status. In this case, an alert is used because the delay warning rate has exceeded 80%.
- C. The time for monitor processing has exceeded 60 seconds of the monitoring timeout and the delay of monitoring is detected. The monitor resource has a problem. In this case, no alert is used.

Alert for the delay warning is used for the heartbeat resources as well.

Related Information:

To configure the delay warning of monitor resources, click **Cluster Properties**, click **Delay Warning**, and select **Monitor Delay Warning**. For details, refer to “Parameter details” in Chapter 2, “Function of the Builder” in this guide.

Waiting for monitor resource to start monitoring

“Wait Time to Start Monitoring” refers to start monitoring after the time period specified as the waiting time elapses.

The following describes how monitoring differs when the wait time to start monitoring is set to 0 second and 30 seconds.

Configuration of monitor resource

<Monitor>

Interval	30 sec
Timeout	60 sec
Retry Count	0 time
Wait Time to Start Monitoring	0 sec / 30 sec

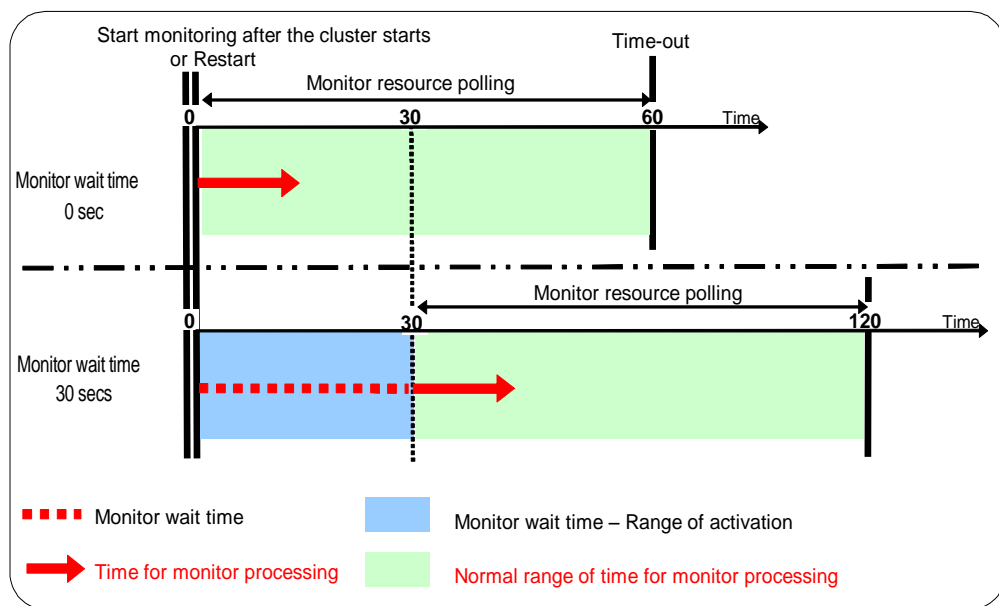

Note:

Monitoring will restart after the time specified to wait for start monitoring has elapsed even when the monitor resource is suspended and/or resumed by using the monitoring control commands.

The wait time to start monitoring is used when there is a possibility for monitoring to be terminated right after the start of monitoring due to incorrect application settings, such as the application resource monitored by application monitor resource, and when they cannot be recovered by reactivation.

For example, when the monitor wait time is set to 0 (zero), recovery may be endlessly repeated. See the example below:

Configuration of application monitor resource

```
<Monitor>
Interval                5 sec
Timeout                 60 sec
Retry Count             Zero
Wait Time to Start Monitoring  0 sec (default)
```

<Error Detection>

```
Recover Target          appli1
Reactivation Threshold  1
Failover Threshold      1
Final Action            Stop Group
```

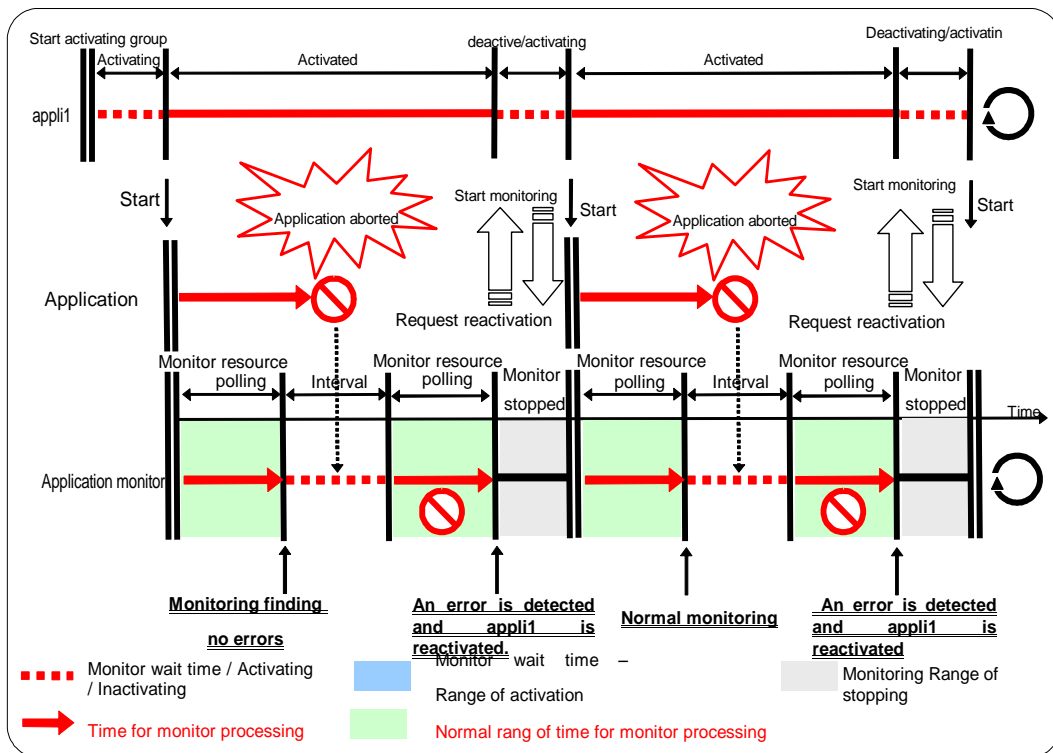

The reason why recovery action is endlessly repeated is because the initial monitor resource polling has terminated successfully. The current count of recoveries the monitor resource has executed is reset when the status of the monitor resource becomes normal (finds no error in the monitor target). Because of this, the current count is always reset to 0 and reactivation for recovery is endlessly repeated.

You can prevent this problem by setting the wait time to start monitoring. By default, 60 seconds is set as the wait time from the application startup to the end.

Configuration of application monitor resource

<Monitor>

Interval 5 sec
 Timeout 60 sec
 Retry Count Zero
 Wait Time to Start Monitoring 60 sec

<Error Detection>

Recover Target appl1
 Reactivation Threshold 1
 Failover Threshold 1
 Final Action Stop Group

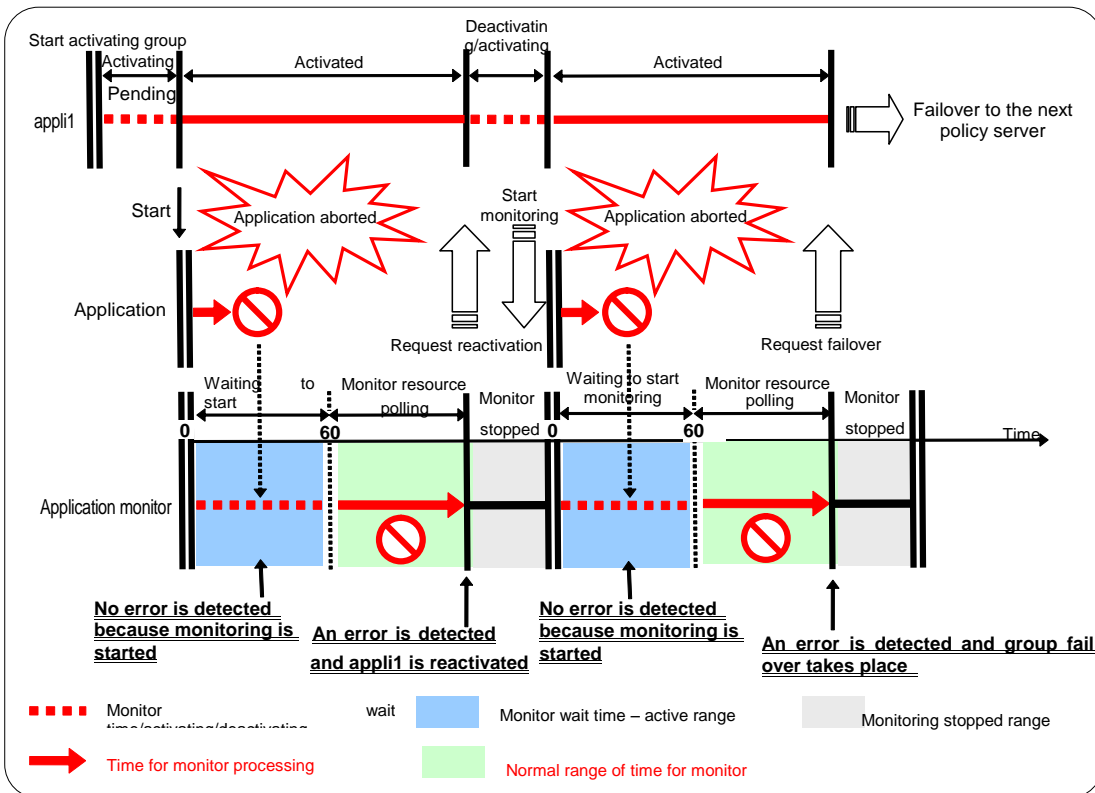

If the application is abnormally terminated in the destination server of the group failover, the group stops as the final action.

When **Stop cluster service and shutdown OS** or **Stop cluster service daemon and reboot OS** is selected as a final action to be taken when an error is detected by the monitor resource, the number of shutdowns or reboots can be limited.

Note:

The maximum reboot count is on a server basis because the number of reboots is recorded on a server basis.

The number of reboots caused by a final action in detection of error in group activation/deactivation and the number of reboots caused by a final action in detection of error by a monitor resource are recorded separately.

If the time to reset the maximum reboot count is set to zero (0), the number of reboots will not be reset.

The following is an example of the process when the number of reboots is limited.

As a final action, **Stop cluster service and reboot OS** is executed once because the maximum reboot count is set to one.

When the monitor resource finds no error in its target for 10 minutes after reboot following cluster shutdown, the number of reboots is reset because the time to reset the maximum reboot count is set to 10 minutes.

Configuration example

<Monitor>

Interval	60 sec
Timeout	120 sec
Retry count	3 times

<Error Detection>

Recovery Target	Failover group A
Reactivation Threshold	zero
Failover Threshold	zero
Final Action	Stop cluster service and reboot OS

< Reboot count limit>

Maximum reboot count	1
Time to reset the maximum reboot count	10 minutes

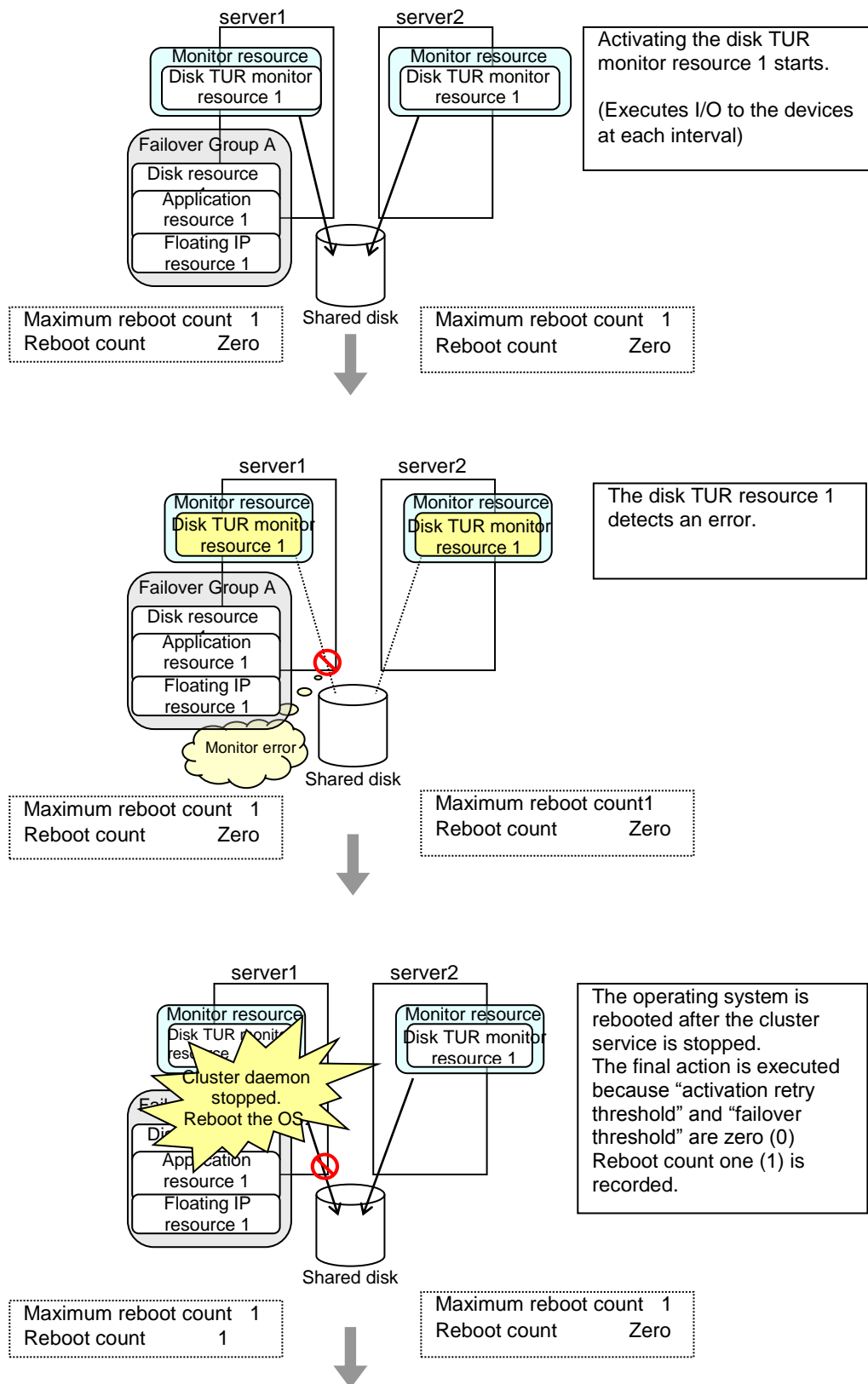

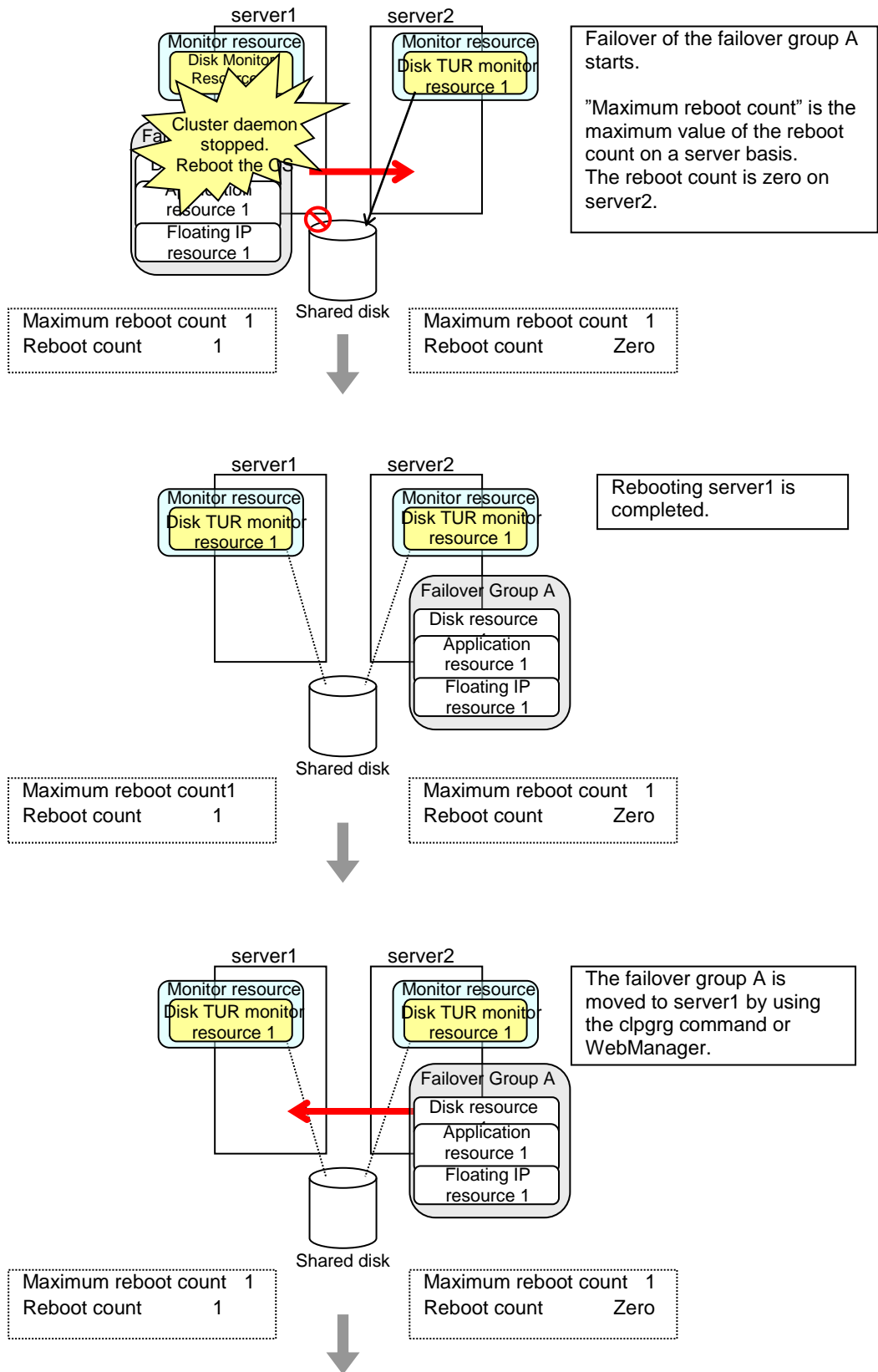

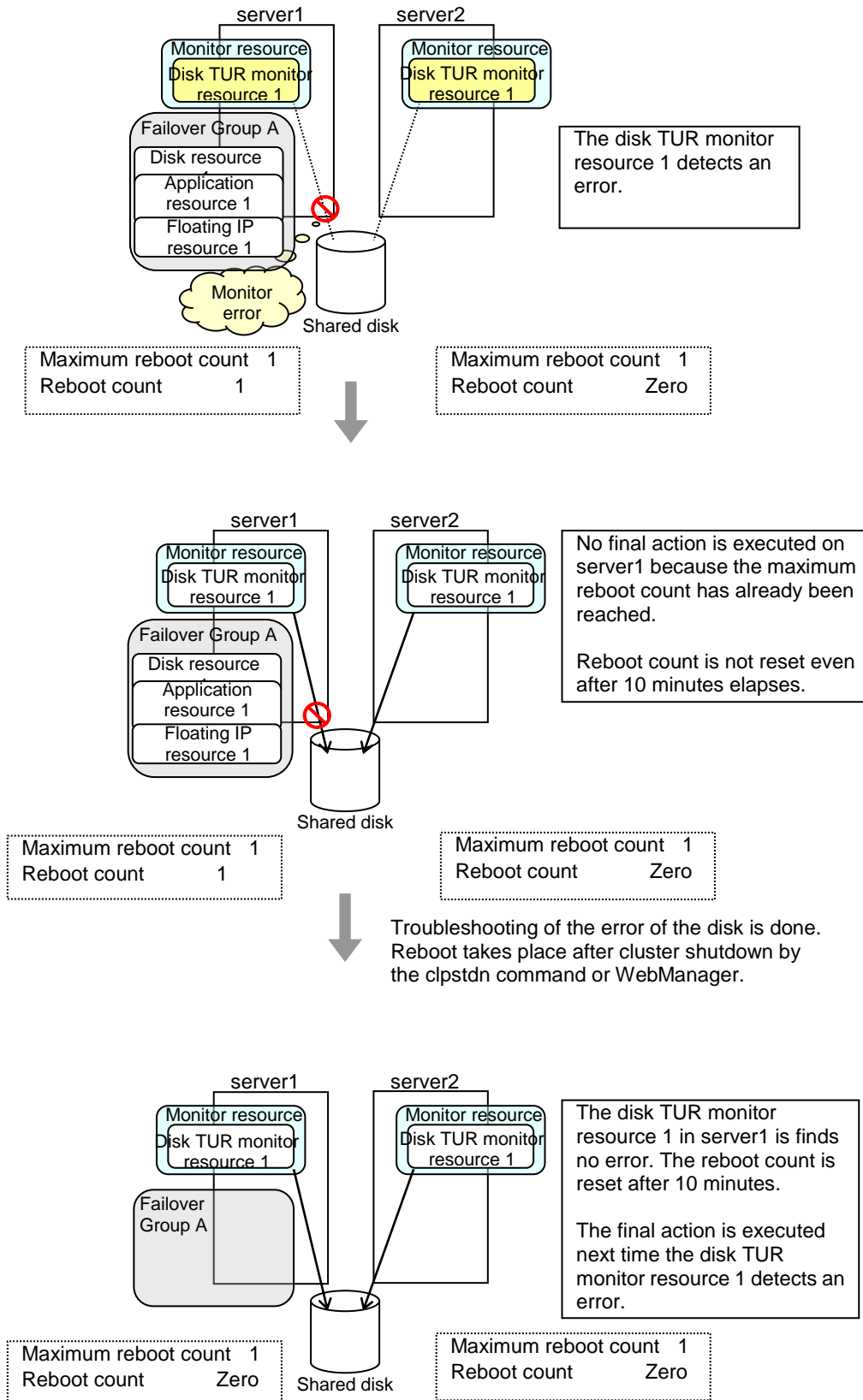

Monitor resources that require a license

Monitor resources listed below require a license because they are optional products. To use these monitor resources, obtain and register a product license.

Optional product name	Monitor resource name
EXPRESSCLUSTER X Database Agent 3.3 for Windows	DB2 monitor resources
	ODBC monitor resources
	Oracle monitor resources
	PostgreSQL monitor resources
	SQL Server monitor resources
EXPRESSCLUSTER X Internet Server Agent 3.3 for Windows	FTP monitor resources
	HTTP monitor resources
	IMAP4 monitor resources
	POP3 monitor resources
	SMTP monitor resources
EXPRESSCLUSTER X Application Server Agent 3.3 for Windows	OracleAS monitor resources
	Tuxedo monitor resources
	Websphere monitor resources
	Weblogic monitor resources
	WebOTX monitor resources
EXPRESSCLUSTER X Anti-Virus Agent 3.3 for Windows	OfficeScan CL monitor resource
	OfficeScan SV monitor resource
EXPRESSCLUSTER X Java Resource Agent 3.3 for Windows	JVM monitor resources
EXPRESSCLUSTER X System Resource Agent 3.3 for Windows	System monitor resources

For information on how to register a license, refer to Chapter 4, “Registering the license” in the *Installation and Configuration Guide*.

Displaying and changing the settings of a monitor resource (common to monitor resources)

Changing the name of a monitor resource

Suspend/Resume

1. In the tree view shown on the left pane of the Builder, click the icon of the monitor resource. In the table view shown on the right side of the screen, right-click the icon of the monitor resource whose name is to be changed, and click **Rename Monitor Resource**.
2. Enter a new name in the **Change Monitor Resource Name** dialog box.

Displaying and changing the comment of a monitor resource

1. In the tree view shown on the left pane of the Builder, right-click the icon of the monitor resource. In the table view shown on the right side of the screen, right-click the icon of the monitor resource whose comment you want to change, and then click **Properties** to display **Monitor Resource Properties**.
2. On the **Info** tab, the monitor resource name and comment are shown. Enter a new comment (within 127 bytes).

Note:

You cannot change the monitor resource name on the **Info** tab. To change the group name, right-click the icon of the group resource as described in the step 1 above. Click **Rename Monitor Resource** and enter a new name.

Displaying and changing the settings of a monitor resource

1. In the tree view shown on the left pane of the Builder, click the icon of the monitor resource.
2. The list of monitor resources is shown in the table view on the right side of the screen. Right-click the name of the monitor resource whose settings you want to change. Click **Properties**, and then click the **Monitor(common)** tab.
3. On the **Monitor(common)** tab, you can see and/or change the settings of monitor resource by following the description below.

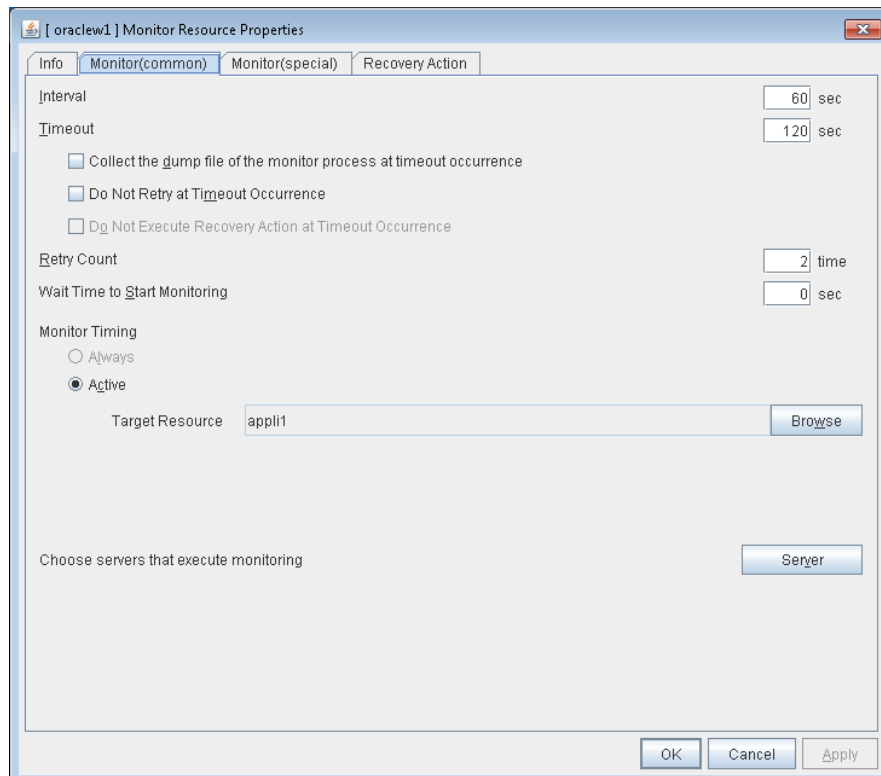

Interval (1 to 999) **SuspendResume**

Specify the interval to check the status of monitor target.

Timeout (5 to 999) **SuspendResume**

When the normal status cannot be detected within the time specified here, the status is determined to be error.

Collect the dump file of the monitor process at timeout occurrence (Only for Oracle monitor resources) **SuspendResume**

Specify whether collecting the dump file of the EXPRESSCLUSTER monitoring process when time out occurs.

The collected dump file is saved in work\rm\resource name\errinfo.cur folder under EXPRESSCLUSTER install folder. When collection is executed more than once, the folder names of the past collection information are renamed as errinfo.1, errinfo.2. And the folders are saved by 5 generations from the latest information.

Do Not Retry at Timeout Occurrence

When this function is enabled, recovery action is executed immediately if a monitor resource timeout occurs

Do Not Execute Recovery Action at Timeout Occurrence

When this function is enabled, recovery action is not executed if a monitor resource timeout occurs.

This can be set only when the **Do Not Retry at Timeout Occurrence** function is enabled.

Note:

For the following monitor resources, the **Do Not Retry at Timeout Occurrence** and **Do Not Execute Recovery Action at Timeout Occurrence** functions cannot be set.

- multi target monitor resources
 - Custom monitor resource (only when Monitor Type is **Asynchronous**)
 - Message receive monitor resource
 - VM monitor resources
 - JVM monitor resource
 - system monitor resource
 - user space monitor resource
-

Retry Count (0 to 999) **SuspendResume**

Specify how many times an error should be detected in a row after the first one is detected before the status is determined as error. If you set this to zero (0), the status is determined as error at the first detection of an error.

Wait Time to Start Monitoring (0 to 9999) **SuspendResume**

Set the wait time to start monitoring.

Monitor Timing **SuspendResume**

Set the monitoring timing. Select the timing from:

- Always:
Monitoring is performed all the time.
- Active:
Monitoring is not started until the specified resource is activated.

Target Resource **SuspendResume**

The resource which will be monitored when activated is shown.

Browse

Click this button to open the dialog box to select the target resource. The group names and resource names that are registered in LocalServer and the cluster are shown in a tree view. Select the target resource and click **OK**.

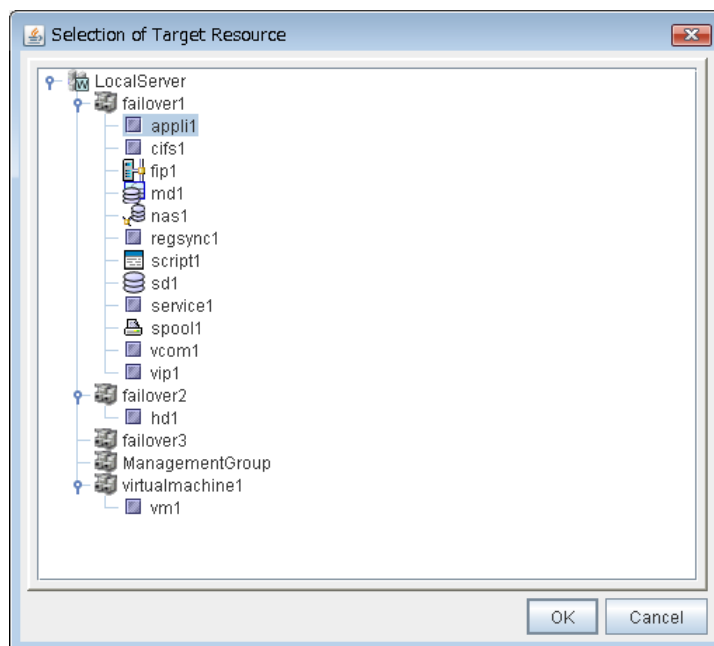

Choose servers that execute monitoring

Choose the servers that execute monitoring.

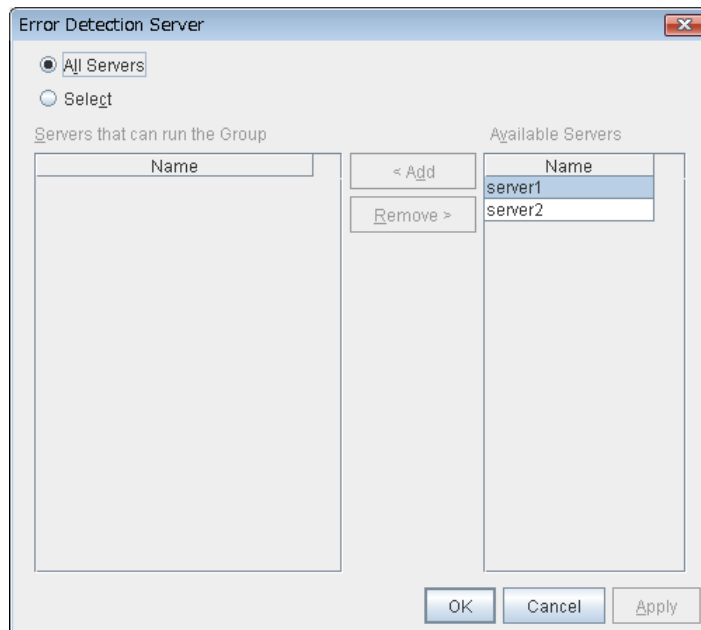

All Servers **SuspendResume**

All servers monitor the resources.

Select **SuspendResume**

Servers registered in **Available Servers** monitor the resources. One or more servers need to be set to **Available Servers**.

Add **SuspendResume**

Click this button to add a server selected in **Available Servers** to **Servers that can run the Group**.

Remove **SuspendResume**

Delete a server selected from **Servers that can run the Group**.

Displaying and changing the settings when an error is detected by a monitor resource

1. In the tree view shown on the left pane of the Builder, click the icon of the monitor resource.
2. The list of monitor resources is shown in the table view on the right side of the screen. Right-click the name of the monitor resource whose settings you want to change or display. Click **Properties**, and then click the **Recovery Action** tab.
3. On the **Recovery Action** tab, display and/or change the monitor settings by following the description below.

Settings for monitor resources other than message receive monitor resources

The screenshot shows the 'Monitor Resource Properties' dialog box for 'oraclew1'. The 'Recovery Action' tab is selected. The dialog contains the following settings:

- Recovery Action:** Execute only the final action
- Recovery Target:** LocalServer (with a 'Browse' button)
- Recovery Script Execution Count:** 0 time
- Execute Script before Reactivation
- Maximum Reactivation Count:** 0 time
- Execute Script before Failover
- Execute migration before failing over
- Failover Target Server:** Stable Server, Maximum Priority Server
- Maximum Failover Count:** Set as much as the number of the servers, Set Number 0 time
- Execute Script before Final Action
- Final Action:** Stop the cluster service and shutdown OS

Buttons at the bottom: 'Script Settings', 'OK', 'Cancel', and 'Apply'.

Settings for message receive monitor resources

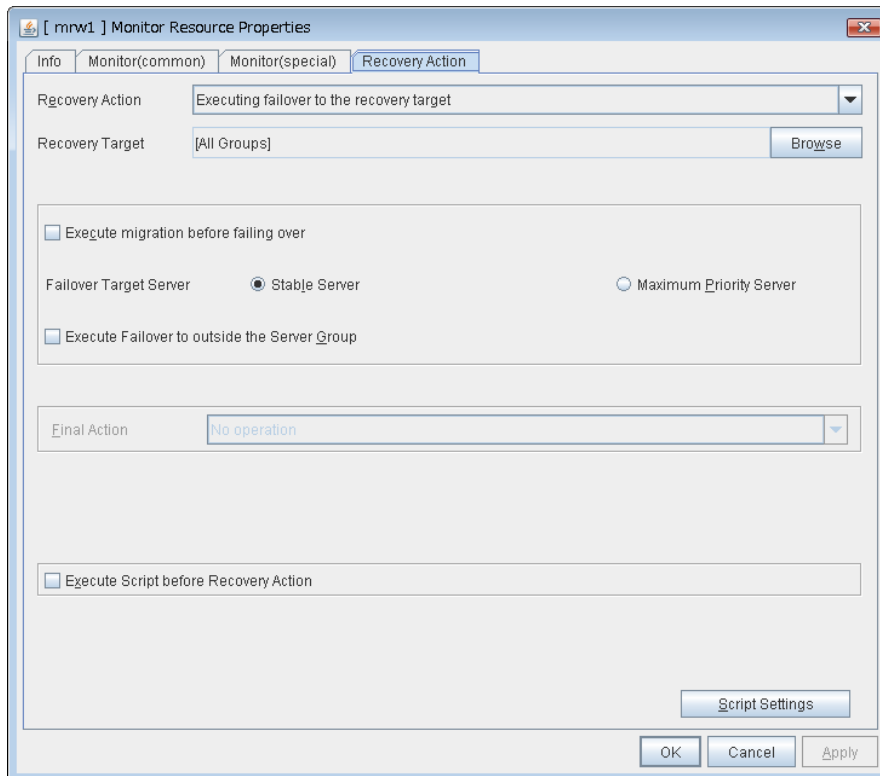

In this dialog box, you can configure the recovery target and an action to be taken at the time when an error is detected. By setting this, it allows failover of the group, restart of the resource and cluster when an error is detected. However, recovery will not occur if the recovery target is not activated.

Recovery Action

Select a recovery action when detecting an error.

- **Executing failover the recovery target**
When detecting a monitor error, execute failover to the group to which the groups or group resources selected as the recovery target belong.
- **Restart the recovery target, and if there is no effect with restart, then failover**
Reactivate groups or group resources selected as the recovery target. If the reactivation fails, or the same error is detected after the reactivation, then execute failover.
- **Restart the recovery target**
Reactivate the group or group resource selected as the recovery target.
- **Execute only the final action**
Execute the selected action as the final action.
- **Custom setting**
Execute the recovery script up until the maximum script execution count. If an error is continuously detected after script execution, reactivate the selected group or group resource as the recovery target up until the maximum reactivation count. If reactivation fails or the same error is continuously detected after reactivation, and the count reaches the maximum reactivation count, execute failover for the selected group or group resource as the recovery target, up until the maximum failover count. When failover fails or the same error is continuously detected after failover, and the count reaches the maximum failover count, execute the selected action as the final action.

Recovery Target **SuspendResume**

A target is shown, which is to be recovered when it is determined as a resource error.

Browse

Click this button to open the dialog box in which you can select the target resource. LocalServer, All Groups, and the group names and resource names that are registered in the cluster are shown in a tree view. Select the target resource and click **OK**.

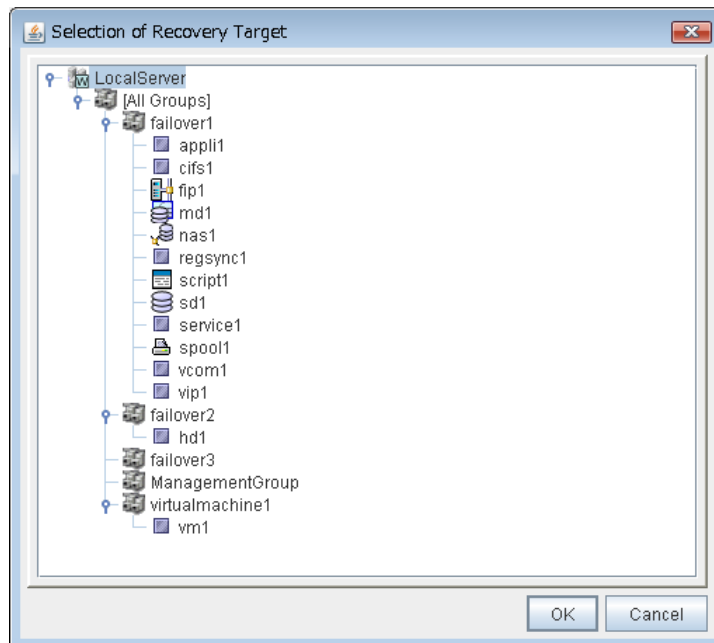

Recovery Script Execution Count (0 to 99) **SuspendResume**

Specify the number of times to allow execution of the script configured by **Script Settings** when an error is detected. If this is set to zero (0), the script does not run.

Execute Script before Reactivation **SuspendResume**

Specify whether to run the script before reactivation.

Maximum Reactivation Count (0 to 99) **SuspendResume**

Specify how many times you allow reactivation when an error is detected. If this is set to zero (0), no reactivation is executed. This is enabled when a group or group resource is selected as a recovery target. This cannot be set for message receive monitor resources.

If a group for which dynamic failover is set or a resource that belongs to the group is set as the recovery target of an IP monitor resource or NIC Link Up/Down monitor resource, reactivation of the recovery target fails because an error is detected in the monitor resource registered as a critical monitor resource.

Execute Script before Failover **SuspendResume**

Specify whether to run the script before failover.

Execute migration before failing over **SuspendResume**

Specify whether trying quick migration (suspending the virtual machine and moving) before failover when the recovery target is the failover group of the virtual machine type or the resource in the group.

- When the checkbox is selected:
Execute quick migration before failover. When quick migration fails, execute normal failover.
- When not selected
Do not execute quick migration.

Failover Target Server **SuspendResume**

Select a Failover Target Server for the failover that takes place after reactivation retries upon activation error detection have failed for the number of times specified in **Retry Count at Activation Failure**.

- Stable Server
The failover destination is the server where least resource errors have been detected. If two or more servers that meet the above condition exist, failover takes place by selecting one of them according to the failover policy of the group..
- Maximum Priority Server
Failover takes place according to the failover policy settings of the group.

Execute Failover to outside the Server Group **SuspendResume**

Can be configured only for message receive monitor resources. Specify whether to fail over to a server group other than the active server group upon the reception of an error message.

Maximum Failover Count (0 to 99) **SuspendResume**

Specify how many times you allow failover after reactivation fails for the number of times set in **Reactivation Threshold** when an error is detected. If this is set to zero (0), no failover is executed. This is enabled when a group or group resource or All Groups is selected as a recovery target. This cannot be set for message receive monitor resources.

- Set as much as the number of the servers
Specify the number of servers as the number of failovers to occur.
- Set Number
Specify any number of times to a failover threshold.

Execute Script before Final Action

Select whether script is run or not before executing final action.

- When the checkbox is selected:
A script/command is run before executing final action. To configure the script/command setting, click **Script Settings**.
- When the checkbox is not selected:
Any script/command is not run.

Execute Script before Recovery Action

Select whether script is run or not before executing recovery action. This can be set only for a message receive monitor resource.

- When the checkbox is selected:
A script/command is run before executing recovery action. To configure the script/command setting, click **Script Settings**.
- When the checkbox is not selected:
Any script/command is not run.

Script Settings

Click here to display the **Edit Script** dialog box. Set the recovery script/command.

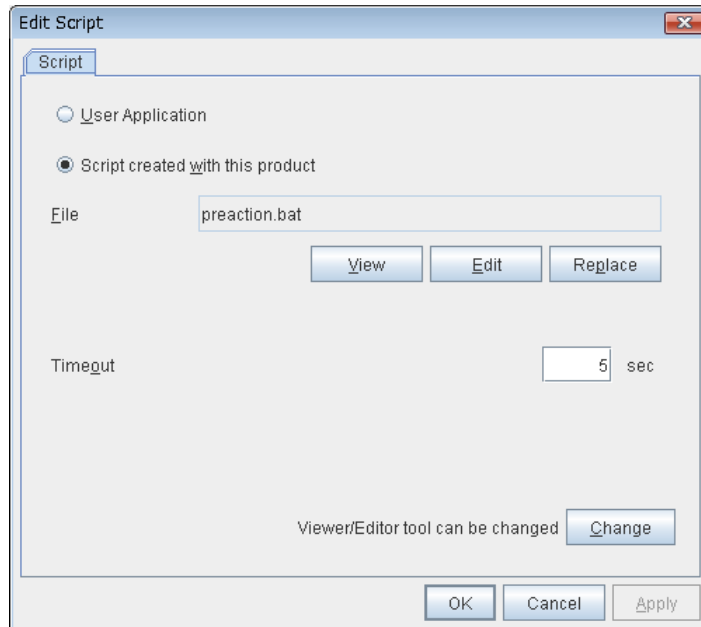

User Application

Use an executable file (executable batch file or execution file) on the server as a script. For the file name, specify an absolute path or name of the executable file of the local disk on the server. If you specify only the name of the executable file, you must configure the path with environment variable in advance. If there is any blank in the absolute path or the file name, put them in double quotation marks (“”) as follows.

Example:

“C:\Program Files\script.bat”

If you want to execute VBScript, enter a command and VBScript file name as follows.

Example:

cscript script.vbs

Each executable file is not included in the cluster configuration information of the Builder. They must be prepared on each server because they cannot be edited or uploaded by the Builder.

Script created with this product

Use a script file which is prepared by the Builder as a script. You can edit the script file with the Builder if you need. The script file is included in the cluster configuration information.

File (Within 1023 bytes)

Specify a script to be executed (executable batch file or execution file) when you select **User Application**.

View

Click here to display the script file with the editor when you select **Script created with this product**. The information edited and stored with the editor is not applied. You cannot display the script file if it is currently displayed or edited.

Edit

Click here to edit the script file with the editor when you select **Script created with this product**. Overwrite the script file to apply the change. You cannot edit the script file if it is currently displayed or edited. You cannot modify the name of the script file.

Replace

Click here to replace the contents of a script file with the contents of the script file which you selected in the file selection dialog box when you select **Script created with this product**. You cannot replace the script file if it is currently displayed or edited. Select a script file only. Do not select binary files (applications), and so on.

Timeout (1 to 9999)

Specify the maximum time to wait for completion of script to be executed. The default value is set as 5.

Change

Click here to display the **Change Script Editor** dialog. You can change editor for displaying or editing a script to an arbitrary editor.

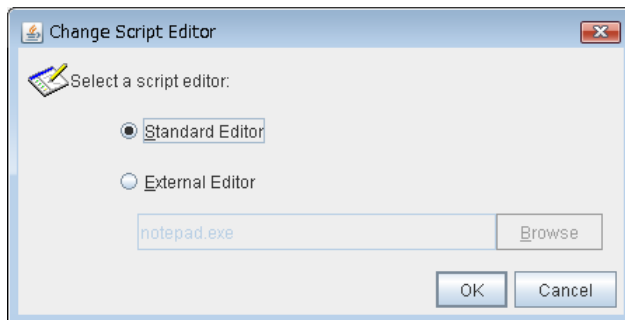

Standard Editor

Select here to use a standard editor (Notepad (notepad.exe)) as a script editor.

External Editor

Select here to specify an arbitrary script editor. Click **Browse** to specify the editor to be used.

Final Action **SuspendResume**

Select a final action to be taken after reactivation fails for the number of times set in **Reactivation Threshold**, and failover fails for the number of times set in **Failover Threshold** when an error is detected.

Select the final action from the options below:

- **No Operation**
No action is taken.

Note:

Use **No Operation** to:

- Suppress the final action temporarily
 - Show only alerts on detection of an error
 - Take the final action practically with multi-target monitor resources
-

- **Stop Resource**
When a group resource is selected as a recovery target, the selected group resource and group resources that depend on the selected group resource are stopped.
This option is disabled when “LocalServer”, “All Groups”, or a group is selected.
- **Stop Group**
When a group or group resource is selected as a monitor target, this option stops the group or the group that the group resource belongs. When **All Groups** is selected, all the groups running on the server of which a monitor resource has detected an error are stopped. This is disabled when a LocalServer is selected as a monitor target.
- **Stop the cluster service**
Stop the EXPRESSCLUSTER Server service of the server that detected an error.
- **Stop the cluster service and shutdown OS**
Stop the EXPRESSCLUSTER Server service of the server that detected an error, and then shuts down the OS.
- **Stop the cluster service and reboot OS**
Stop the EXPRESSCLUSTER Server service of the server that detected an error, and then reboots the OS.
- **Generating an intentional Stop Error**
Intentionally cause stop error for the server that detected an error.

Displaying and changing parameters of a monitor resource

Some monitor resources require parameter setting for monitoring. For displaying and changing parameters, please refer to explanations of each monitor resource that described on following pages.

Understanding application monitor resources

Application monitor resources monitor application resources.

Monitoring by application monitor resources

Application monitor resources monitor application resources in a server where they are activated. They regularly monitor whether applications are active or not. When they detect that applications do not exist, it is determined to be an error.

Note on application monitor resources

An application monitor resource monitors a successfully activated application resource. The application resource can be monitored if it is specified as a resident type resource.

Application monitor resources are automatically registered when the resident type is set to **Resident** on addition of an application resource. Application monitor resources corresponding to an application resource are automatically registered.

Application monitor resources are initially defaulted, so configure appropriate resource settings as needed.

On addition of an application resource whose resident type is **Non-Resident**, application monitor resources cannot be added to it.

Displaying the application monitor resource properties with the WebManager

1. Start the WebManager (*http://Management IP address or the IP address of the cluster server: port_number* (the default value is 29003)).
2. Click an object for the application monitor resources  in the tree view. The following information is displayed in the list view.

Application Monitor Name: appliw1		Details	
Common		server1	server2
Properties	Value		
Comment			
Status	Normal		
Resource Status on Each Server			
Server Name	Status		
server1	Normal		
server2	Offline		

Comment: Comment for the application monitor resource
 Status: Status of the application monitor resource

Resource Status on Each Server
 Server Name: Server name of each server
 Status: Status of the monitor resource on the given server

When you click **Details**, the following information is displayed in the pop-up dialog box.

Properties	Value
Name	appliw1
Type	appliw
Monitor Timing	Activating
Target Resource	appli1
Interval	60
Timeout	60
Do Not Retry at Timeout Occurrence	Off
Do Not Execute Recovery Action at Timeout Occurrence	Off
Retry Count	1
Final Action	No operation
Execute Script Before Reactivation	Off
Execute Script Before Failover	Off
Execute Script before Final Action	Off
Recovery Target	appli1
Recovery Target Type	Resource
Recovery Script Threshold	0
Reactivation Threshold	3
Failover Target Server	Stable Server
Failover Threshold	Number of Servers
Wait Time to Start Monitoring	0
Dummy Failure Possibility	Possible
Collect Dump at Timeout Occurrence	Off
Run Migration Before Run Failover	Off

Name:	Application monitor resource name
Type:	Monitor resource type
Monitor Timing:	Timing for the monitor resource to start monitoring
Target Resource:	Resource to be monitored
Interval (sec):	Interval between monitoring (in seconds)
Timeout (sec):	Timeout for monitoring (in seconds)
Do Not Retry at Timeout Occurrence:	Whether or not to retry when timeout occurs
Do Not Execute Recovery Action at Timeout Occurrence:	Whether or not to execute recovery action when timeout occurs
Retry Count:	The number of retries to be made from detection of an error in the monitor target to establish the error as error
Final Action:	Final action at detection of an error
Execute Script before Reactivation:	Whether the pre-reactivation script is executed upon the detection of an error
Execute Script before Failover:	Whether the pre-failover script is executed upon the detection of an error
Execute Script before Final Action:	Whether the pre-final-action script is executed upon the detection of an error
Recovery Target:	Target to be recovered when an error is detected
Recovery Target Type:	Type of target to be recovered when an error is detected
Recovery Script Threshold:	The number of times the recovery script is executed upon the detection of an error
Reactivation Threshold:	The number of times activation is retried when an activation error is detected
Failover Target Server	Determination method of Failover Target Server
Failover Threshold:	The number of failovers to be made at detection of an error
Wait Time to Start Monitoring (sec):	Time to wait before start monitoring (in seconds)
Dummy Failure Possibility:	Possibility of Dummy Failure
Collect Dump at Timeout Occurrence:	Whether or not dump of monitor process is collected when timeout occurs
Run Migration Before Run Failover:	Whether or not migration is run before running failover

Understanding disk RW monitor resources

Disk RW monitor resources monitor disk devices by writing dummy data to the file system.

Monitoring by disk RW monitor resources

Disk RW monitor resources write data to the specified file system (basic volume or dynamic volume) with the specified I/O size and evaluate the result. They solely evaluate whether data was written with the specified I/O size but do not evaluate validity of data. (Created file is deleted after writing)

OS and disk get highly loaded if the size of I/O is large. Depending on disk and/or interface being used, caches for various writing are mounted. Because of this, if the size of I/O is small, a cache hit may occur and an error in writing may not get detected. Intentionally generate a disk error to confirm that the size of I/O is sufficient to detect an error.

Note:

If you want multipath software to initiate path failover when disk path is not connected, you should set longer timeout for disk RW monitor resource than path failover time.

Displaying and changing disk RW monitor resource details

1. Click **Monitors** on the tree view displayed on the left side of the Builder window.
2. List of the monitor resources is displayed in the table view on the right side of the screen. Right click the target disk RW monitor resource, and click the **Monitor(special)** tab in the **Monitor Resource Property** window.
3. On the **Monitor(special)** tab, you can display and/or change the detailed settings by following the description below.

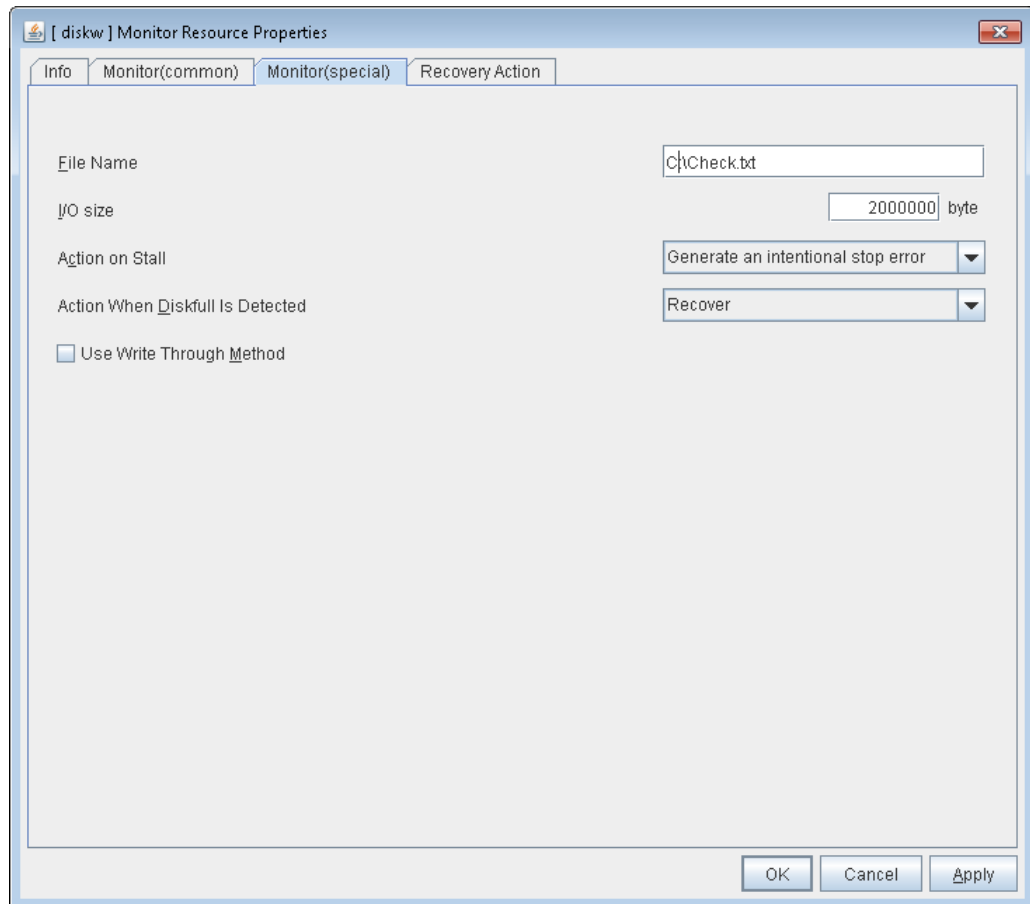

File Name Within 1023 bytes **SuspendResume**

Enter the file name to access. This file is created upon monitoring and deleted after I/O completes.

Note:

Specify an absolute path for the file name. If a relative path is specified for the file name, the disk RW monitor resource may monitor the unexpected place.

Important:

Do not specify any existing file for the file name. If an existing file is specified for the file name, the data of the file is lost.

I/O size (1 to 9999999) **SuspendResume**

Specify the I/O size for the disk to monitor.

Action when stalling is detected **SuspendResume**

Specify the action to take when stalling is detected.

Stalling is detected if I/O control is not returned from the OS within the time specified in **Timeout** of the **Monitor (common)** tab.

- No Operation
No action is taken.
- HW Reset⁶
Reset the hardware.
- Generating of intentional Stop Error
Intentionally cause a stop error.

Note:

A Dummy Failure cannot be triggered by a stall.

Action when diskfull is detected **Server Individual Setup**

Select the action when diskfull (state in which the disk being monitored has no free space) is detected

- Recover
The disk monitor resource recognizes an error upon the detection of disk full.
- Do not recover
The disk monitor resource recognizes a caution upon the detection of disk full

Use Write Through Method **SuspendResume**

Applies the Write Through method to the monitor I/O method.

- If the Write Through method is enabled, the error detection precision of the disk RW monitor will improve. However, the I/O load on the system may increase.

⁶ This function does not require ipmiutil, unlike the forced stop function.

Displaying the disk RW monitor resource properties with the WebManager

1. Start the WebManager (http://Management IP address or the IP address of the cluster server:port_number (the default value is 29003)).
2. Click an object for the disk RW monitor resources  in the tree view. The following information is displayed in the list view.

Disk RW Monitor Name: diskw1		Details	
Common		server1	server2
Properties	Value		
Comment			
File Name	M:\diskw		
Status	Normal		
Resource Status on Each Server			
Server Name	Status		
server1	Normal		
server2	Offline		

Comment: Comment for the disk RW monitor resource
 File Name: Path to the file name on the file system to monitor
 Status: Status of the disk RW monitor resource

Resource Status on Each Server
 Server Name: Server name of each server
 Status: Status of the disk RW monitor resource on the given server

When you click **Details**, the following information is displayed in the pop-up dialog box.

Properties	Value
Name	diskw1
Type	diskw
Monitor Timing	Activating
Target Resource	appli1
Interval	30
Timeout	300
Do Not Retry at Timeout Occurrence	Off
Do Not Retry at Timeout Occurrence	Off
Retry Count	0
Final Action	No operation
Execute Script Before Reactivation	Off
Execute Script Before Failover	Off
Execute Script before Final Action	Off
Recovery Target	LocalServer
Recovery Target Type	Itself
Recovery Script Threshold	0
Reactivation Threshold	0
Failover Target Server	Stable Server
Failover Threshold	0
Wait Time to Start Monitoring	0
Dummy Failure Possibility	Possible
Collect Dump at Timeout Occurrence	Off
Run Migration Before Run Failover	Off
I/O Size (byte)	2000000
Action On Stall	Stop Error
Action when diskfull is detected	Recover
Use Write Through Method	Disable

Name:	Disk RW monitor resource name
Type:	Monitor resource type
Monitor Timing:	Timing to start monitoring
Target Resource:	Resource to be monitored
Interval (sec):	Interval between monitoring (in seconds)
Timeout (sec):	Timeout for monitoring (in seconds)
Do Not Retry at Timeout Occurrence:	Whether or not to retry when timeout occurs
Do Not Execute Recovery Action at Timeout Occurrence:	Whether or not to execute recovery action when timeout occurs
Retry Count:	The number of retries to be made from detection of an error in the monitor target to establish the error as error
Final Action:	Final action at detection of an error
Execute Script before Reactivation:	Whether the pre-reactivation script is executed upon the detection of an error
Execute Script before Failover:	Whether the pre-failover script is executed upon the detection of an error
Execute Script before Final Action:	Whether the pre-final-action script is executed upon the detection of an error
Recovery Target:	Target to be recovered when an error is detected
Recovery Target Type:	Type of target to be recovered when an error is detected
Recovery Script Threshold:	The number of times the recovery script is executed upon the detection of an error
Reactivation Threshold:	The number of times activation is retried when an activation error is detected
Failover Target Server:	Determination method of Failover Target Server
Failover Threshold:	The number of failovers to be made at detection of an error
Wait Time to Start Monitoring (sec):	Time to wait before start monitoring (in seconds)
Dummy Failure Possibility:	Possibility of Dummy Failure
Collect Dump at Timeout Occurrence:	Whether or not dump of monitor process is collected when timeout occurs
Run Migration Before Run Failover:	Whether or not migration is run before running failover
I/O size (Byte):	Write size (byte)
Action on Stall:	Action when stalling is detected
Action when diskfull is detected:	Action when diskfull is detected
Use Write Through Method	The use of the Write Through method is enabled or disabled.

Understanding floating IP monitor resources

Floating IP monitor resources monitor floating IP resources.

Monitoring by floating IP monitor resources

Floating IP resources monitor floating IP resources in a server where they are activated. Floating IP monitor resources monitor whether floating IP addresses exist in the list of IP addresses. If a floating IP address does not exist in the list of IP addresses, it is determined to be an error.

Floating IP resources monitor link up/down of NIC where a floating IP address is active. If NIC link down is detected, it is considered as an error.

Windows Server 2008 R2 or earlier uses the DeviceIoControl function, and depending on the NIC driver, the necessary DeviceIoControl function may not be supported. In this case, this setting cannot be used.

Windows Server 2012 or later uses WMI, and this setting can be used.

Note on floating IP monitor resources

- This monitor resource is automatically registered when a floating IP resource is added. A floating IP monitor resource corresponding to a floating IP resource is automatically registered.
Floating IP monitor resources are initially defaulted, so configure appropriate resource settings as needed.

Displaying and changing floating IP monitor resource details

1. Click **Monitors** on the tree view displayed on the left side of the Builder window.
2. List of the monitor resources is displayed in the table view on the right side of the screen. Right click the target floating IP monitor resource, and click the **Monitor(special)** tab in the **Monitor Resource Property** window.
3. On the **Monitor(special)** tab, you can display and/or change the detailed settings by following the description below.

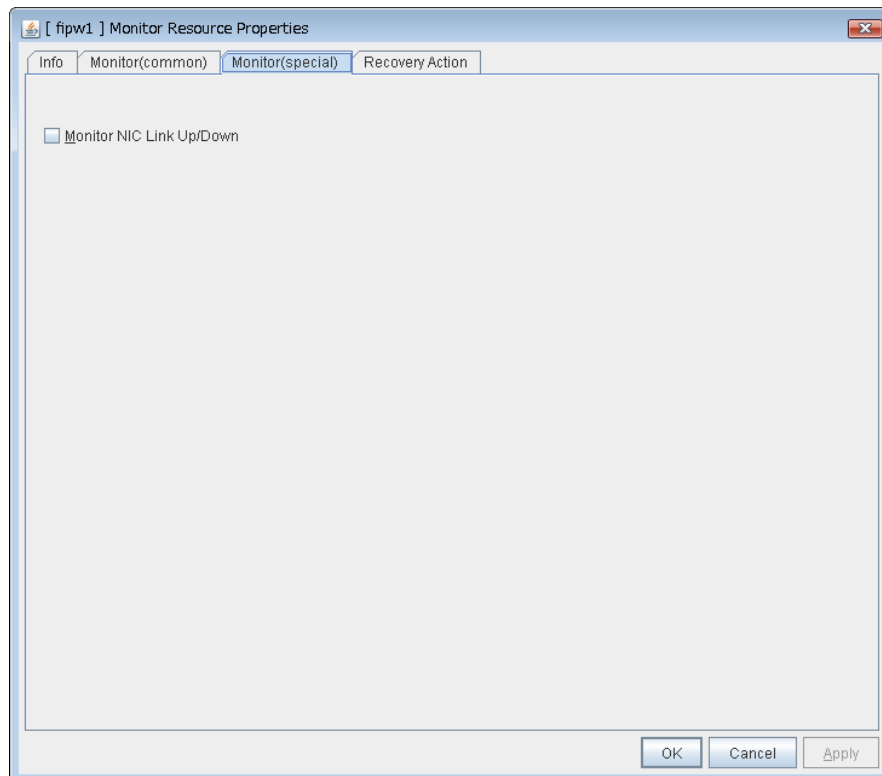

Monitor NIC Link Up/Down

Specify whether to monitor NIC Link Up/Down.

Displaying the floating IP monitor resource properties with the WebManager

1. Start the WebManager (*http://Management IP address or the IP address of the cluster server: port_number* (the default value is 29003)).
2. Click an object for the application monitor resources  in the tree view. The following information is displayed in the list view.

Floating IP Monitor Name: fipw1		Details
Common server1 server2		
Properties	Value	
Comment		
Status	Normal	
Resource Status on Each Server		
Server Name	Status	
server1	Normal	
server2	Offline	

Comment: Comment for floating the IP monitor resource
 Status: Status of the floating IP monitor resource

Resource Status on Each Server
 Server Name: Server name of each server
 Status: Status of the monitor resource on the given server

When you click **Details**, the following information is displayed in the pop-up dialog box.

Properties	Value
Name	fipw1
Type	fipw
Monitor Timing	Activating
Target Resource	fip1
Interval	60
Timeout	60
Do Not Retry at Timeout Occurrence	Off
Do Not Retry at Timeout Occurrence	Off
Retry Count	1
Final Action	No operation
Execute Script Before Reactivation	Off
Execute Script Before Failover	Off
Execute Script before Final Action	Off
Recovery Target	fip1
Recovery Target Type	Resource
Recovery Script Threshold	0
Reactivation Threshold	3
Failover Target Server	Stable Server
Failover Threshold	Number of Servers
Wait Time to Start Monitoring	0
Dummy Failure Possibility	Possible
Collect Dump at Timeout Occurrence	Off
Run Migration Before Run Failover	Off
Monitor NIC Link Up/Down	Off

Name: Floating IP monitor resource name
 Type: Monitor resource type
 Monitor Timing: Timing for the monitor resource to start monitoring
 Target Resource: Resource to be monitored

Interval (sec):	Interval between monitoring (in seconds)
Timeout (sec):	Timeout for monitoring (in seconds)
Do Not Retry at Timeout Occurrence:	Whether or not to retry when timeout occurs
Do Not Execute Recovery Action at Timeout Occurrence:	Whether or not to execute recovery action when timeout occurs
Retry Count:	The number of retries to be made from detection of an error in the monitor target to establish the monitor resource as error
Final Action:	Final action at detection of an error
Execute Script before Reactivation:	Whether the pre-reactivation script is executed upon the detection of an error
Execute Script before Failover:	Whether the pre-failover script is executed upon the detection of an error
Execute Script before Final Action:	Whether the pre-final-action script is executed upon the detection of an error
Recovery Target:	Target to be recovered when an error is detected
Recovery Target Type:	Type of target to be recovered when an error is detected
Recovery Script Threshold:	The number of times the recovery script is executed upon the detection of an error
Reactivation Threshold:	The number of times activation is retried when an activation error is detected
Failover Target Server:	Determination method of Failover Target Server
Failover Threshold:	The number of failovers to be made at detection of an error
Wait Time to Start Monitoring (sec):	Time to wait before start monitoring (in seconds)
Dummy Failure Possibility:	Possibility of Dummy Failure
Collect Dump at Timeout Occurrence:	Whether or not dump of monitor process is collected when timeout occurs
Run Migration Before Run Failover:	Whether or not migration is run before running failover
Monitor NIC Link Up/Down:	Monitor/Do not monitor NIC Link Up/Down

Understanding IP monitor resources

IP monitor resource is a monitor resource which monitors IP addresses by using the ping command depending on whether there is a response or not.

Monitoring by IP monitor resources

IP monitor resource monitors specified IP addresses by using the ping command. If all IP addresses do not respond, the status is determined to be error.

If you want to establish error when all of the multiple IP addresses have error, register all those IP addresses with one IP monitor resource.

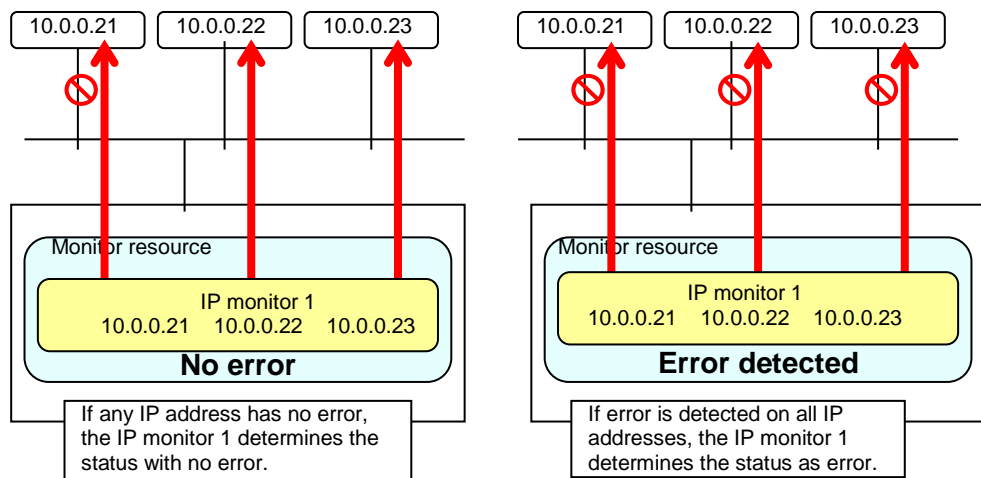

If you want to establish error when any one of IP addresses has an error, create one IP monitor resource for each IP address.

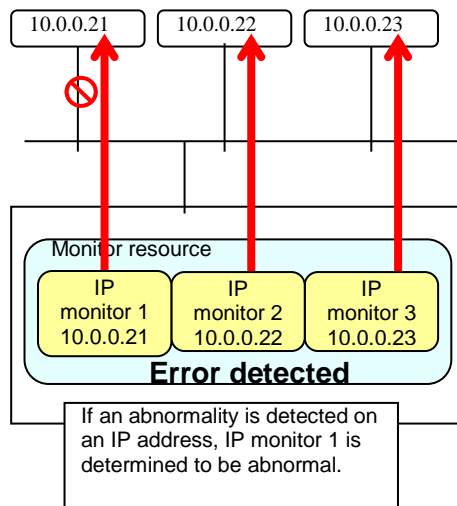

Displaying and changing IP monitor resource details

1. Click **Monitors** on the tree view displayed on the left side of the Builder window.
2. List of the monitor resources is displayed in the table view on the right side of the screen. Right click the target IP monitor resource, and click the **Monitor(special)** tab in the **Monitor Resource Property** window.
3. On the **Monitor(special)** tab, you can display and/or change the detailed settings by following the description below.

IP addresses to be monitored are listed in **IP Addresses**.

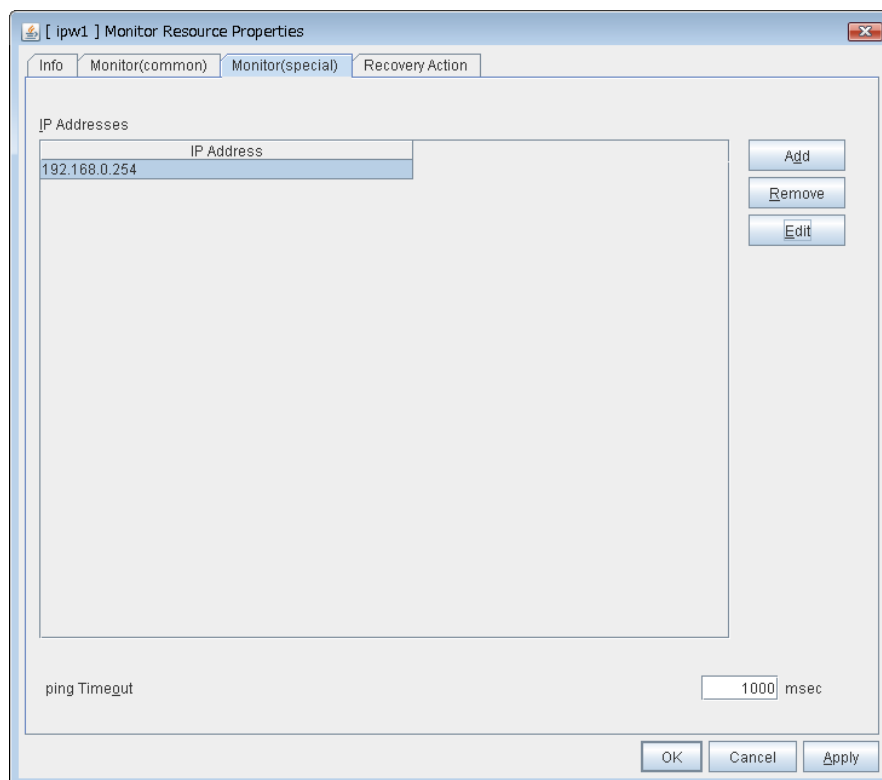

Add

Click **Add** to add an IP address to be monitored.

A dialog box where you can enter an IP address is displayed.

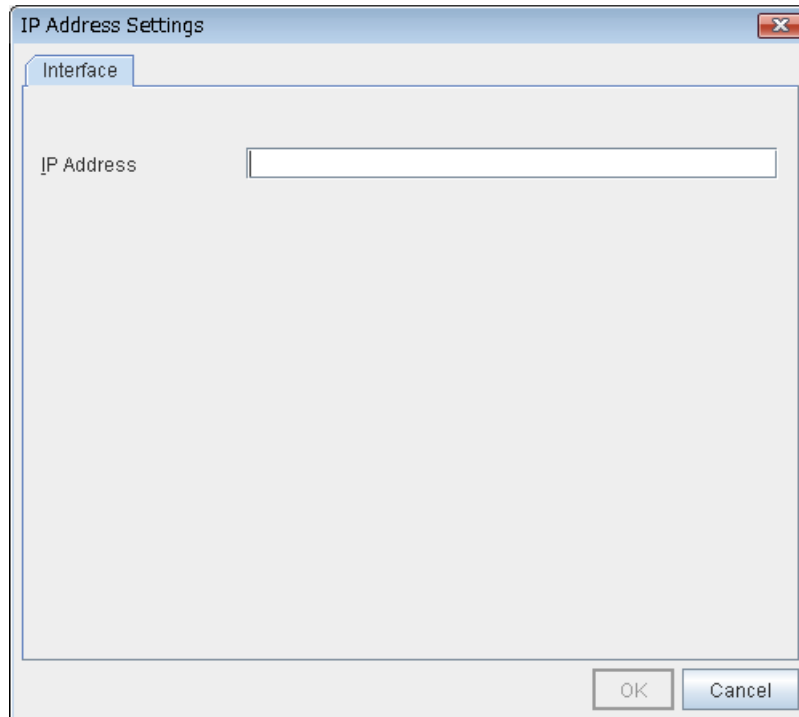
**IP Address** (within 255 bytes)

Enter an IP address to be monitored in this field and click **OK**. The IP address to be entered here should be the one that exists on the public LAN.

Remove

Click **Remove** to remove an IP address selected in **IP Addresses** from the list so that it will no longer be monitored.

Edit

Click **Edit** to display the **IP Address Settings** dialog box. The dialog box shows the IP address selected in **IP Addresses** on the **Parameter** tab. Edit the IP address and click **OK**.

Ping Timeout (1 to 999999)

Specify the timeout of the ping to be sent to monitor the IP address in milliseconds.

Displaying the IP monitor resource properties with the WebManager

1. Start the WebManager (*http://Management IP address or the IP address of the cluster server: port_number* (the default value is 29003)).
2. Click an IP monitor object, , in the tree view. The following information is displayed in the list view.

IP Monitor Name: ipw1		Details
Common server1 server2		
Properties	Value	
Comment		
IP Address List	192.168.0.254	
Ping Timeout (milliseconds)	1000	
Status	Normal	
Resource Status on Each Server		
Server Name	Status	
server1	Normal	
server2	Normal	

Comment: Comment on the IP monitor resource
IP Address List: IP address to be monitored by IP monitor resource IP
Ping Timeout (milliseconds): Ping timeout (milliseconds)
Status: IP monitor resource status

Resource Status on Each Server
Server Name: Server name of each server
Status: Status of the monitor resource on the server

When you click **Details**, the following information is displayed in the pop-up dialog box.

Properties	Value
Name	ipw1
Type	ipw
Monitor Timing	Always
Target Resource	
Interval	60
Timeout	60
Do Not Retry at Timeout Occurrence	Off
Do Not Retry at Timeout Occurrence	Off
Retry Count	1
Final Action	No operation
Execute Script Before Reactivation	Off
Execute Script Before Failover	Off
Execute Script before Final Action	Off
Recovery Target	LocalServer
Recovery Target Type	Itself
Recovery Script Threshold	0
Reactivation Threshold	0
Failover Target Server	Stable Server
Failover Threshold	0
Wait Time to Start Monitoring	0
Dummy Failure Possibility	Possible
Collect Dump at Timeout Occurrence	Off
Run Migration Before Run Failover	Off

Name: IP monitor resource name
Type: Monitor resource type
Monitor Timing: Timing for monitor resource to start monitoring

Target Resource:	Resource to be monitored
Interval (sec):	Interval between monitoring (in seconds)
Timeout (sec):	Timeout for monitoring (in seconds)
Do Not Retry at Timeout Occurrence:	Whether or not to retry when timeout occurs
Do Not Execute Recovery Action at Timeout Occurrence:	Whether or not to execute recovery action when timeout occurs
Retry Count:	The number of retries to be made from detection of an error in the monitor target to establish the monitor resource as error
Final Action:	Final action at detection of an error
Execute Script before Reactivation:	Whether the pre-reactivation script is executed upon the detection of an error
Execute Script before Failover:	Whether the pre-failover script is executed upon the detection of an error
Execute Script before Final Action:	Whether the pre-final-action script is executed upon the detection of an error
Recovery Target:	Target to be recovered when an error is detected
Recovery Target Type:	Type of target to be recovered when an error is detected
Recovery Script Threshold:	The number of times the recovery script is executed upon the detection of an error
Reactivation Threshold:	The number of reactivations to be made at detection of an error
Failover Target Server:	Determination method of Failover Target Server
Failover Threshold:	The number of failovers to be made at detection of an error
Wait Time to Start Monitoring (sec):	Time to wait before start monitoring (in seconds)
Dummy Failure Possibility:	Possibility of Dummy Failure
Collect Dump at Timeout Occurrence:	Whether or not dump of monitor process is collected when timeout occurs
Run Migration Before Run Failover:	Whether or not migration is run before running failover

Understanding mirror connect monitor resources

Note on mirror connect monitor resources

A mirror disk connect monitor resource monitors a network for mirroring. If communication of mirror data using the specified mirror connect fails, it is recognized as an error. This resource is automatically registered when a mirror disk resource is added.

When this resource is deleted, be careful that auto mirror recovery cannot be executed.

Refer to “Connecting mirror disks/hybrid disks manually Automatically recovering from mirroring” in “Chapter 11 Troubleshooting” in this guide for the details.

Displaying and changing the mirror connect monitor resource details - For Replicator -

1. Click **Monitors** on the tree view displayed on the left side of the Builder window.
2. List of the monitor resources is displayed in the table view on the right side of the screen. Right click the target mirror disk monitor resource, and click the **Monitor(special)** tab in the **Monitor Resource Property** window.
3. On the **Monitor(special)** tab, you can display and/or change the detailed settings by following the description below.

Note:

Do not change the settings shown below on the **Error Detection** tab. With these settings, you can send an alert message if an error is determined.

The **Error Detection** tab settings:

Recovery Target	Cluster name
Reactivation Threshold	Zero (Never)
Failover Threshold	Zero (Never)
Final Action	No Operation

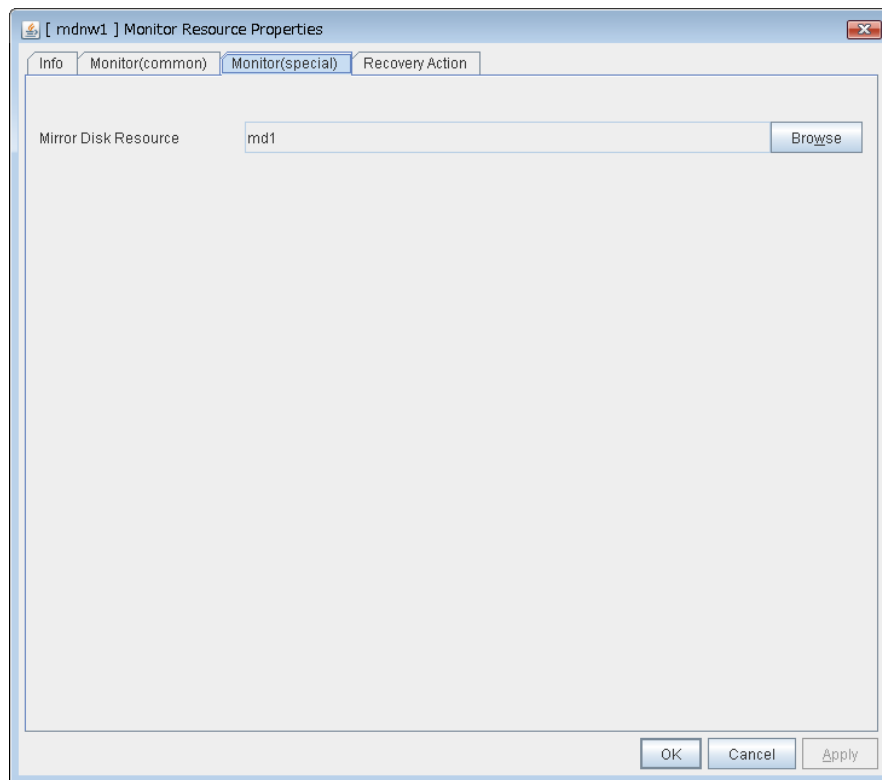

Mirror Disk Resource ~~SuspendResume~~

The mirror disk resource to be monitored is displayed.

Browse

Click this button to display the dialog box where you can select a mirror disk resource to be monitored. Mirror disk resources registered with the cluster are displayed in a tree view. You can select only mirror disk resources in this view. Select a mirror disk resource and click **OK**.

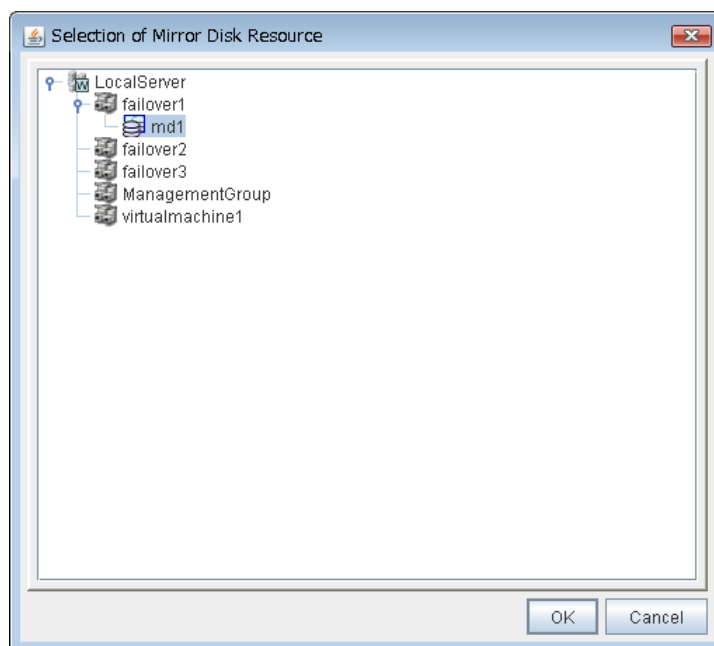

Displaying the mirror connect monitor resource properties with the WebManager

1. Start the WebManager (*http://Management IP address or the IP address of the cluster server: port_number* (the default value is 29003)).
1. Click a mirror connect monitor object, , in the tree view. The following information is displayed in the list view.

Mirror Connect Monitor Name: mdnw1		Details
Common server1 server2		
Properties	Value	
Comment		
Mirror Disk Resource Name	md1	
Status	Normal	
Resource Status on Each Server		
Server Name	Status	
server1	Normal	
server2	Normal	

- Comment: Comment of the mirror connect monitor resource
- Mirror Disk Resource Name: Name of the mirror disk resource to be monitored by mirror connect monitor resource
- Status: Mirror connect monitor resource status
- Resource Status on Each Server
- Server Name: Server name of each server
- Status: Status of the monitor resource on the given server

When you click **Details**, the following information is displayed in the pop-up dialog box.

Properties	Value
Name	mdnw1
Type	mdnw
Monitor Timing	Always
Target Resource	
Interval	60
Timeout	20
Do Not Retry at Timeout Occurrence	Off
Do Not Retry at Timeout Occurrence	Off
Retry Count	0
Final Action	No operation
Execute Script Before Reactivation	Off
Execute Script Before Failover	Off
Execute Script before Final Action	Off
Recovery Target	md1
Recovery Target Type	Resource
Recovery Script Threshold	0
Reactivation Threshold	0
Failover Target Server	Stable Server
Failover Threshold	0
Wait Time to Start Monitoring	0
Dummy Failure Possibility	Impossible
Collect Dump at Timeout Occurrence	Off
Run Migration Before Run Failover	Off

- Name Mirror connect monitor resource name

Type:	Monitor resource type
Monitor Timing:	Timing for the monitor resource to start monitoring
Target Resource:	Resource to be monitored
Interval (sec):	Interval between monitoring (in seconds)
Timeout (sec):	Timeout for monitoring (in seconds)
Do Not Retry at Timeout Occurrence:	Whether or not to retry when timeout occurs
Do Not Execute Recovery Action at Timeout Occurrence:	Whether or not to execute recovery action when timeout occurs
Retry Count:	The number of retries to be made from detection of an error in the monitor target to establish the monitor resource as error.
Final Action:	Final action at detection of an error
Execute Script before Reactivation:	Whether the pre-reactivation script is executed upon the detection of an error
Execute Script before Failover:	Whether the pre-failover script is executed upon the detection of an error
Execute Script before Final Action:	Whether the pre-final-action script is executed upon the detection of an error
Recovery Target:	Target to be recovered when an error is detected
Recovery Target Type:	Type of target to be recovered when a problem is detected
Recovery Script Threshold:	The number of times the recovery script is executed upon the detection of an error
Reactivation Threshold:	The number of reactivations to be made at detection of an error
Failover Target Server:	Determination method of Failover Target Server
Failover Threshold	The number of failovers to be made at detection of an error
Wait Time to Start Monitoring (sec):	Time to wait before starting monitoring (in seconds)
Dummy Failure Possibility:	Possibility of Dummy Failure
Collect Dump at Timeout Occurrence:	Whether or not dump of monitor process is collected when timeout occurs
Run Migration Before Run Failover:	Whether or not migration is run before running failover

Understanding mirror disk monitor resources

Mirror monitor resources monitor a mirror partition device or mirror driver works properly.

Note on mirror disk monitor resources

This resource is automatically registered when a mirror disk resource is added. A mirror disk monitor resource corresponding to the mirror disk resource is automatically registered. When this resource is deleted, be careful that auto mirror recovery cannot be executed.

Refer to “Connecting mirror disks/hybrid disks manually Automatically recovering from mirroring” in “Chapter 11 Troubleshooting” in this guide for the details.

Displaying and changing the mirror disk monitor resource details

1. Click **Monitors** on the tree view displayed on the left side of the Builder window.
2. List of the monitor resources is displayed in the table view on the right side of the screen. Right-click the target mirror disk monitor resource, and click the **Monitor(special)** tab in the **Monitor Resource Property** window.
3. On the **Monitor(special)** tab, you can display and/or change the detailed settings by following the description below.

Note:

Do not change the settings shown below on the Error Detection tab.

The Error Detection tab settings:

Recovery object Mirror disk resource name

Reactivation threshold Zero (Never)

Failover Target Server Stable operation server

Failover threshold Set as many as the number of the servers

Final Action No Operation

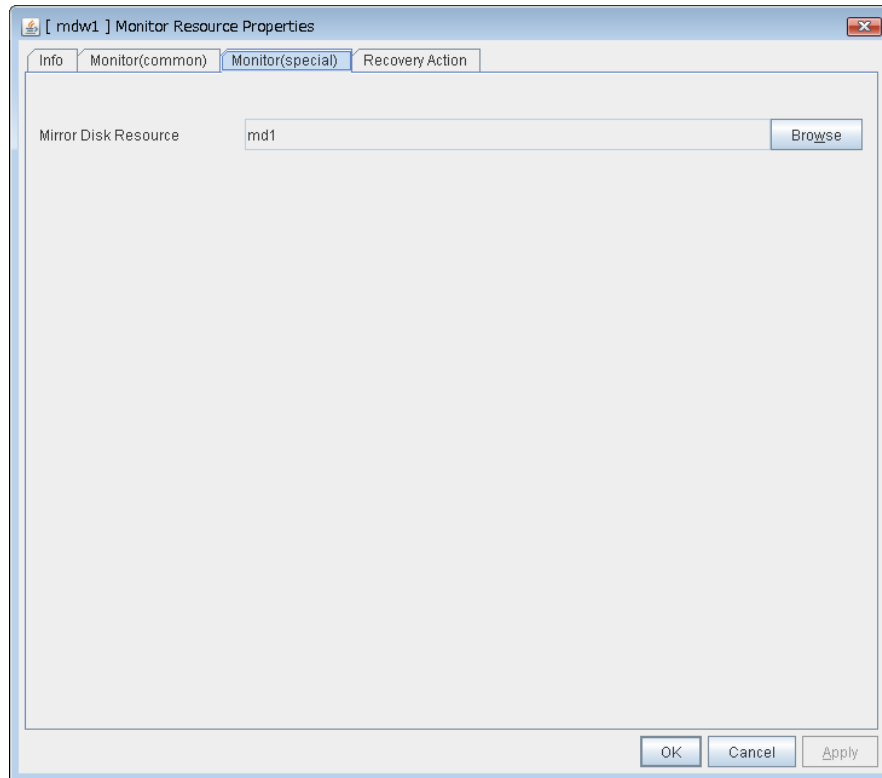

Mirror Disk Resource SuspendResume

The mirror disk resource to be monitored is displayed.

Browse

Click this button to display the dialog box where you can select a mirror disk resource to be monitored. Mirror disk resources registered with the cluster are displayed in a tree view. You can select only mirror disk resources in this view. Select a mirror disk resource and click OK.

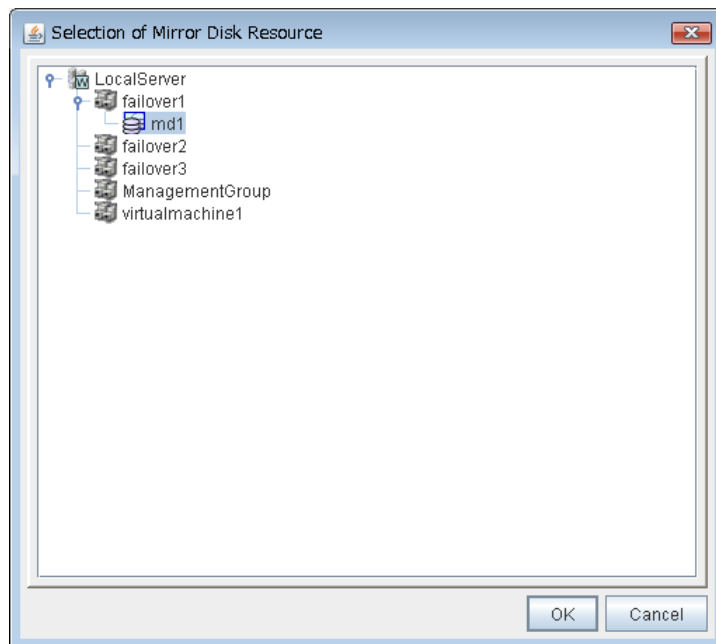

Displaying the mirror disk monitor resource properties with the WebManager

1. Start the WebManager (*http://Management IP address or the IP address of the cluster server: port_number* (the default value is 29003)).
2. Click an object for a mirror disk monitor resource, , in the tree view. The following information is displayed in the list view.

Mirror Disk Monitor Name: mdw1		Details	
Common		server1	server2
Properties	Value		
Comment			
Mirror Disk Resource Name	md1		
Status	Normal		
Resource Status on Each Server			
Server Name	Status		
server1	Normal		
server2	Normal		

- Comment: Comment of the mirror disk monitor resource
- Mirror Disk Resource Name: Name of the mirror disk resource to be monitored by the mirror disk monitor resource
- Status: Mirror disk monitor resource status
- Resource Status on Each Server
- Server Name: Server name of each server
- Status: Status of the monitor resource on the given server

When you click **Details**, the following information is displayed in the pop-up dialog box.

Properties	Value
Name	mdw1
Type	mdw
Monitor Timing	Always
Target Resource	
Interval	30
Timeout	999
Do Not Retry at Timeout Occurrence	Off
Do Not Execute Recovery Action at Timeout Occurrence	Off
Retry Count	1
Final Action	No operation
Execute Script Before Reactivation	Off
Execute Script Before Failover	Off
Execute Script before Final Action	Off
Recovery Target	md1
Recovery Target Type	Resource
Recovery Script Threshold	0
Reactivation Threshold	0
Failover Target Server	Stable Server
Failover Threshold	Number of Servers
Wait Time to Start Monitoring	10
Dummy Failure Possibility	Impossible
Collect Dump at Timeout Occurrence	Off
Run Migration Before Run Failover	Off

Name	Mirror disk monitor resource name
Type:	Monitor resource type
Monitor Timing:	Timing for the monitor resource to start monitoring
Target Resource:	Resource to be monitored
Interval (sec):	Interval between monitoring (in seconds)
Timeout (sec):	Timeout for monitoring (in seconds)
Do Not Retry at Timeout Occurrence:	Whether or not to retry when timeout occurs
Do Not Execute Recovery Action at Timeout Occurrence:	Whether or not to execute recovery action when timeout occurs
Retry Count:	The number of retries to be made from detection of an error in the monitor target to establish the monitor resource as error.
Final Action:	Final action at detection of an error
Execute Script before Reactivation:	Whether the pre-reactivation script is executed upon the detection of an error
Execute Script before Failover:	Whether the pre-failover script is executed upon the detection of an error
Execute Script before Final Action:	Whether the pre-final action script is executed upon the detection of an error
Recovery Target:	Target to be recovered when an error is detected
Recovery Target Type:	Type of target to be recovered when an error is detected
Recovery Script Threshold:	The number of times the recovery script is executed upon the detection of an error
Reactivation Threshold:	The number of reactivations to be made at detection of an error
Failover Target Server:	Determination method of Failover Target Server
Failover Threshold:	The number of failovers to be made at detection of an error
Wait Time to Start Monitoring (sec):	Time to wait before starting monitoring (in seconds)
Dummy Failure Possibility:	Possibility of Dummy Failure
Collect Dump at Timeout Occurrence:	Whether or not dump of monitor process is collected when timeout occurs
Run Migration Before Run Failover:	Whether or not migration is run before running failover

Understanding NIC link up/down monitor resources

NIC Link Up/Down monitor resource obtains the information on how the specified NIC is linked and monitors the linkage is up or down.

Note on NIC link up/down monitor resources

- ◆ Windows Server 2008 R2 or earlier uses the DeviceIoControl function, and depending on the NIC driver, the necessary DeviceIoControl function may not be supported, in which case you cannot use this monitor resource. Windows Server 2012 or later uses WMI, and this setting can be used.

Configuration and range of NIC link up/down monitoring

- For Windows Server 2008 R2 or earlier, the DeviceIoControl function to the NIC driver is used to find how the server is linked to the network.
Windows Server 2012 or later uses WMI.
(For the IP monitor resource, the status is judged by the ping response from the specified IP address.)
- You can monitor an NIC dedicated to interconnect (mirror connect). If you do this in the environment where two nodes are directly connected with a cross cable and one server fails, the other server is considered to be failing. This is because no link is established.
The recovery action to be taken at detection of error should be configured with the appropriate value.
For example, if you select **Stop cluster service and reboot OS**, other servers will continue to restart the OS endlessly.

Displaying and changing the NIC link up/down monitor resource details

1. Click **Monitors** on the tree view displayed on the left side of the Builder window.
2. List of the monitor resources is displayed in the table view on the right side of the screen.
Right click the target NIC Link Up/Down monitor resource, and click the **Monitor(special)** tab in the **Monitor Resource Property** window.
3. On the **Monitor(special)** tab, you can display and/or change the detailed settings by following the description below.

NIC Link Up/Down monitor resource Monitor(special) tab

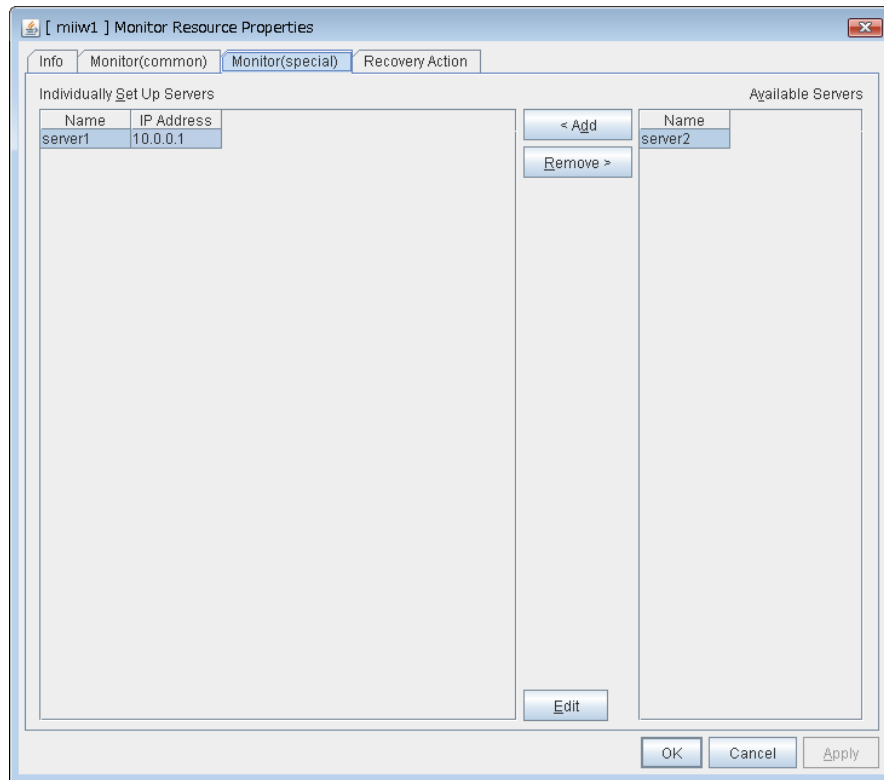

Add

Add the IP address of the NIC to be monitored to the list of monitoring servers.

Delete

Delete the IP address of the NIC to be monitored from the list of monitoring servers.

Edit

Edit the IP address of the NIC to be monitored.

NIC Link Up/Down monitor resource add/edit properties

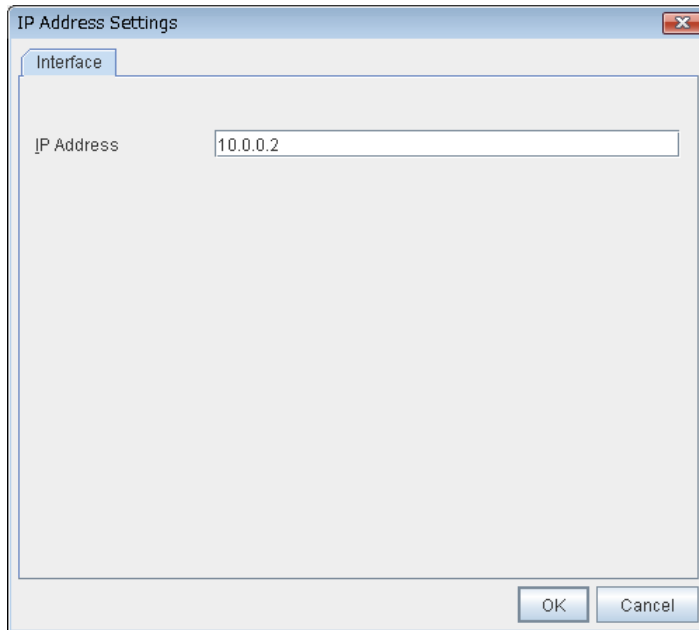

IP Address Within 47 bytes

Specify the IP address of the NIC to be monitored.

Displaying the NIC link up/down monitor resource properties with the WebManager

1. Start the WebManager (*http://Management IP address or the IP address of the cluster server: port_number* (the default value is 29003)).
2. Click a NIC Link Up/Down monitor resource object, , in the tree view. The following information is displayed in the list view.

NIC Link Up/Down Monitor Name: miiw1		Details
Common server1 server2		
Properties	Value	
Comment		
Status	Normal	
Resource Status on Each Server		
Server Name	Status	
server1	Normal	
server2	Normal	

Comment: Comment of the NIC Link Up/Down monitor resource
 Status: NIC Link Up/Down monitor resource status

Resource Status on Each Server

Server Name: Server name of each server
 Status: Status of the monitor resource on the given server

When you click **Details**, the following information is displayed in the pop-up dialog box.

Properties	Value
Name	miiw1
Type	miiw
Monitor Timing	Always
Target Resource	
Interval	60
Timeout	60
Do Not Retry at Timeout Occurrence	Off
Do Not Execute Recovery Action at Timeout Occurrence	Off
Retry Count	1
Final Action	No operation
Execute Script Before Reactivation	Off
Execute Script Before Failover	Off
Execute Script before Final Action	Off
Recovery Target	LocalServer
Recovery Target Type	Itself
Recovery Script Threshold	0
Reactivation Threshold	0
Failover Target Server	Stable Server
Failover Threshold	0
Wait Time to Start Monitoring	0
Dummy Failure Possibility	Possible
Collect Dump at Timeout Occurrence	Off
Run Migration Before Run Failover	Off

- Name: NIC Link Up/Down monitor resource name
- Type: Monitor resource type
- Monitor Timing: Timing for the monitor resource to start monitoring
- Target Resource: Resource to be monitored
- Interval (sec): Interval between monitoring (in seconds)
- Timeout (sec): Timeout for monitoring (in seconds)
- Do Not Retry at Timeout Occurrence: Whether or not to retry when timeout occurs
- Do Not Execute Recovery Action at Timeout Occurrence: Whether or not to execute recovery action when timeout occurs
- Retry Count: The number of retries to be made from detection of an error in the monitor target to establish the monitor resource as error
- Final Action: Final action at detection of an error
- Execute Script before Reactivation: Whether the pre-reactivation script is executed upon the detection of an error
- Execute Script before Failover: Whether the pre-failover script is executed upon the detection of an error
- Execute Script before Final Action: Whether the pre-final action script is executed upon the detection of an error
- Recovery Target: Target to be recovered when an error is detected
- Recovery Target Type: Type of target to be recovered when an error is detected
- Recovery Script Threshold: The number of times the recovery script is executed upon the detection of an error
- Reactivation Threshold: The number of reactivations to be made at detection of an error
- Failover Target Server: Determination method of Failover Target Server
- Failover Threshold: The number of failovers to be made at detection of an error
- Wait Time to Start Monitoring (sec): Time to wait before starting monitoring (in seconds)
- Dummy Failure Possibility: Possibility of Dummy Failure
- Collect Dump at Timeout Occurrence: Whether or not dump of monitor process is collected when timeout occurs
- Run Migration Before Run Failover: Whether or not migration is run before running failover

Understanding multi target monitor resources

The multi target monitor resource monitors more than one monitor resources.

Note on the multi target monitor resource

The multi target monitor resources regard the offline status of registered monitor resources as being an error. For this reason, for a monitor resource that performs monitoring when the target is active is registered, the multi target monitor resource might detect an error even when an error is not detected by the monitor resource. Do not, therefore, register monitor resources that perform monitoring when the target is active.

Multi target monitor resource status

The status of the multi target monitor resource is determined by the status of registered monitor resources.

The table below describes status of multi target monitor resource when the multi target monitor resource is configured as follows:

The number of registered monitor resources	2
Error Threshold	2
Warning Threshold	1

The table below describes status of a multi target monitor resource:

Multi target monitor resource status		Monitor resource1 status		
		Normal	Error	Offline
Monitor resource2 status	Normal	normal	caution	caution
	Error	caution	error	error
	Offline	caution	error	normal

- Multi target monitor resource monitors status of registered monitor resources.
If the number of the monitor resources with the error status exceeds the error threshold, multi target monitor resource detects an error.
If the number of the monitor resources with the caution status exceeds the caution threshold, the status of the multi target monitor resource becomes caution.
If all registered monitor resources are in the status of stopped (offline), the status of multi-target monitor resource becomes normal.
Unless all the registered monitor resources are stopped (offline), the multi target monitor resource recognizes the stopped (offline) status of a monitor resource as error.
- If the status of a registered monitor resource becomes error, actions for the error of the monitor resource are not executed.
Actions for error of the multi target monitor resource are executed only when the status of the multi target monitor resource becomes error.

Displaying and changing the details of the multi target monitor resource

1. Click **Monitors** on the tree view displayed on the left pane of the Builder window.
2. List of monitor resources is displayed in the table view on the right side of the screen. Right-click the multi target monitor resource. Then click **Properties** and select **Monitor(special)** tab.
3. On the **Monitor(special)** tab, you can display and/or change the detailed settings by following the description below.

Monitor resources are grouped and the status of the group is monitored. You can register up to 64 monitor resources in the **Monitor Resources**.

When the only one monitor resource set in the **Monitor Resources** is deleted, the multi target monitor resource is deleted automatically.

Multi target monitor resource Monitor(special) tab

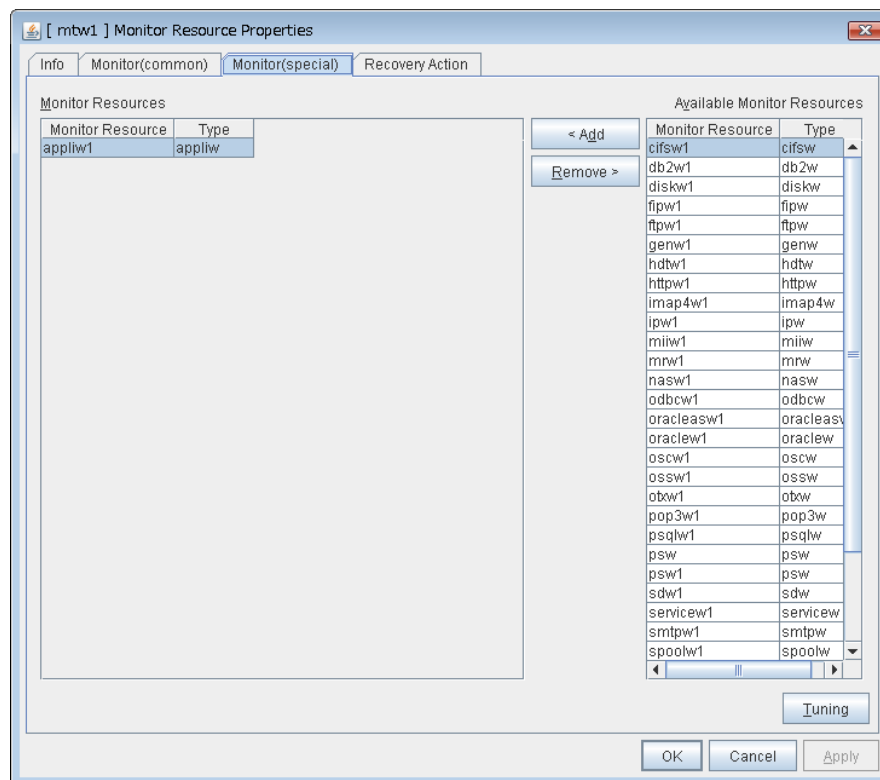

Add **SuspendResume**

Click **Add** to add a selected monitor resource to **Monitor Resources**.

Remove **SuspendResume**

Click **Remove** to delete a selected monitor resource from **Monitor Resources**.

Tuning multi target monitor resource

1. From the tree view displayed in the left pane of the Builder, click the **Monitors** icon.
2. The list of monitor resources is displayed on the table view in the right pane of the window. Right-click the target multi target monitor resource name. Click **Properties**, and then click **Monitor(special)**.
3. Click **Tuning** on the **Monitor(special)** tab. The **MultiTarget Monitor Resource Tuning Properties** dialog box is displayed.
4. The settings of multi target monitor resource can be displayed and changed by following the description below.

Parameter tab

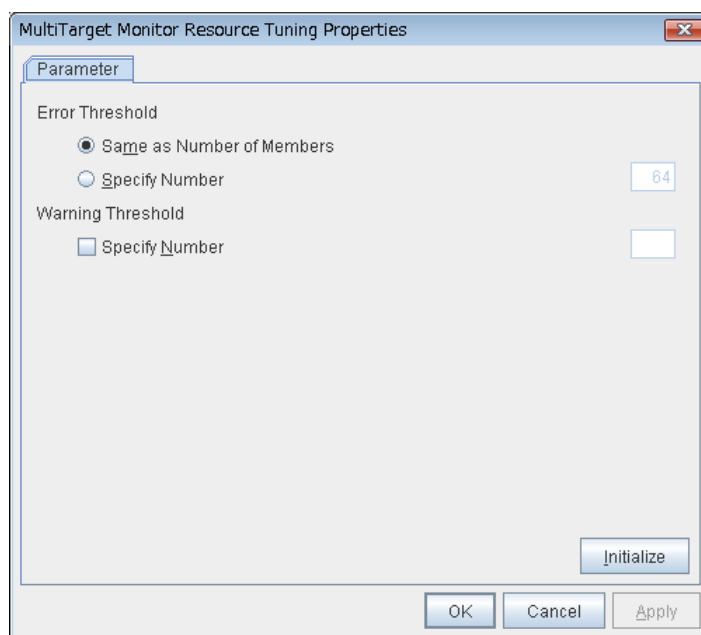

Error Threshold

Select the condition for multi target monitor resources to be determined as an error.

- Same as Number of Members

The status of multi target monitor resources becomes “Error” when all monitor resources specified to be under the multi target monitor resource are failed, or when “Error” and “Offline” co-exist.

The status of multi target monitor resources becomes “Normal” when the status of all monitor resources specified to be under the multi target monitor resource are “Offline.”

- Specify Number

The status of multi target monitor resources becomes “Error” when the number of monitor resources specified in **Error Threshold** becomes “Error” or “Offline.”

When the status of some monitor resources among those specified to be under the multi target monitor resource, specify how many monitor resources need to be “Error” or “Offline” to determine that the status of multi target monitor resource is “Error.”

Warning Threshold

- When the checkbox is selected:
When the status of some monitor resources among those specified to be under the multi target monitor resource, specify how many monitor resources need to be “Error” or “Offline” to determine that the status of multi target monitor resource is “Caution.”
- When the checkbox is not selected:
Multi target monitor resources do not display an alert.

Initialize

Clicking **Initialize** resets all items to their default values.

Displaying the properties of the multi target monitor resource with the WebManager

- Start the WebManager (*http://Management IP address or the IP address of the cluster server: port_number* (the default value is 29003)).
- Click an object for a multi target monitor resource  in the tree view. The following information is displayed in the list view.

Multi Target Monitor Name: mtw1		Details
<div style="display: flex; justify-content: space-between;"> Common server1 server2 </div>		
Properties	Value	
Comment		
Monitor Resource List	appliw1 diskw1 fipw1	
Status	Normal	
Resource Status on Each Server		
Server Name	Status	
server1	Normal	
server2	Normal	

- Comment: Comment of the multi target monitor resource
- Monitor Resource List: List of monitor resources
- Status: Multi target monitor resource status
- Resource Status on Each Server
- Server Name: Server name of each server
- Status: Status of the monitor resource status on the given server

When you click **Details**, the following information is displayed in the pop-up dialog box.

Properties	Value
Name	mtw1
Type	mtw
Monitor Timing	Always
Target Resource	
Interval	60
Timeout	60
Do Not Retry at Timeout Occurrence	Off
Do Not Execute Recovery Action at Timeout Occurrence	Off
Retry Count	1
Final Action	No operation
Execute Script Before Reactivation	Off
Execute Script Before Failover	Off
Execute Script before Final Action	Off
Recovery Target	LocalServer
Recovery Target Type	Itself
Recovery Script Threshold	0
Reactivation Threshold	0
Failover Target Server	Stable Server
Failover Threshold	0
Wait Time to Start Monitoring	0
Dummy Failure Possibility	Possible
Collect Dump at Timeout Occurrence	Off
Run Migration Before Run Failover	Off

- Name: Multi target monitor resource name
- Type: Monitor resource type
- Monitor Timing: Timing for the monitor resource to start monitoring
- Target Resource: Resource to be monitored
- Interval (sec): Interval between monitoring (in seconds)
- Timeout (sec): Timeout for monitoring (in seconds)
- Do Not Retry at Timeout Occurrence: Whether or not to retry when timeout occurs
- Do Not Execute Recovery Action at Timeout Occurrence: Whether or not to execute recovery action when timeout occurs
- Retry Count: The number of retries to be made from detection of an error in the monitor target to establish the error as error
- Final Action: Final action at detection of an error
- Execute Script before Reactivation: Whether the pre-reactivation script is executed upon the detection of an error
- Execute Script before Failover: Whether the pre-failover script is executed upon the detection of an error
- Execute Script before Final Action: Whether the pre-final action script is executed upon the detection of an error
- Recovery Target: Target to be recovered when an error is detected
- Recovery Target Type: Type of target to be recovered when an error is detected
- Recovery Threshold: The number of times the recovery script is executed upon the detection of an error
- Reactivation Threshold: The number of reactivations to be made at detection of an error
- Failover Target Server: Determination method of Failover Target Server
- Failover Threshold: The number of failovers to be made at detection of an error
- Wait Time to Start Monitoring (sec): Time to wait before starting of monitoring (in seconds)
- Dummy Failure Possibility: Possibility of Dummy Failure
- Collect Dump at Timeout Occurrence: Whether or not dump of monitor process is collected when timeout occurs
- Run Migration Before Run Failover: Whether or not migration is run before running failover

Understanding registry synchronization monitor resources

Registry synchronization monitor resources monitor registry synchronization resources.

Note on registry synchronization monitor resources

- This monitor resource is automatically registered when a registry synchronization resource is added. A registry synchronization monitor resource corresponding to a registry synchronization resource is automatically registered. Registry synchronization monitor resources are initially defaulted, so configure appropriate resource settings as needed.

Displaying and changing the details of the registry synchronization monitor resources

There is no detailed setting to be made for registry synchronization monitor resources.

Displaying the registry synchronization monitor resources properties with the WebManager

- Start the WebManager (*http://Management IP address or the IP address of the cluster server: port_number* (the default value is 29003)).
- Click a registry synchronization monitor resources object, , in the tree view. The following information is displayed in the list view.

Registry Synchronization Monitor Name: regsyncw1		Details
Common server1 server2		
Properties	Value	
Comment		
Status	Normal	
Resource Status on Each Server		
Server Name	Status	
server1	Normal	
server2	Offline	

Comment: Comment of the registry synchronization monitor resource
 Status: Registry synchronization monitor resource status

Resource Status on Each Server

Server Name: Server name of each server
 Status: Status of the monitor resource status on the given server

When you click **Details**, the following information is displayed in the pop-up dialog box.

Properties	Value
Name	regsyncw1
Type	regsyncw
Monitor Timing	Activating
Target Resource	regsync1
Interval	60
Timeout	60
Do Not Retry at Timeout Occurrence	Off
Do Not Execute Recovery Action at Timeout Occurrence	Off
Retry Count	1
Final Action	No operation
Execute Script Before Reactivation	Off
Execute Script Before Failover	Off
Execute Script before Final Action	Off
Recovery Target	LocalServer
Recovery Target Type	Itself
Recovery Script Threshold	0
Reactivation Threshold	0
Failover Target Server	Stable Server
Failover Threshold	0
Wait Time to Start Monitoring	0
Dummy Failure Possibility	Possible
Collect Dump at Timeout Occurrence	Off
Run Migration Before Run Failover	Off

Name:	Registry synchronization monitor resource name
Type:	Monitor resource type
Monitor Timing:	Timing for the monitor resource to start monitoring
Target Resource:	Resource to be monitored
Interval (sec):	Interval between monitoring (in seconds)
Timeout (sec):	Timeout for monitoring (in seconds)
Do Not Retry at Timeout Occurrence:	Whether or not to retry when timeout occurs
Do Not Execute Recovery Action at Timeout Occurrence:	Whether or not to execute recovery action when timeout occurs
Retry Count:	The number of retries to be made from detection of an error in the monitor target to establish the monitor resource as error
Final Action:	Final action at detection of an error
Execute Script before Reactivation:	Whether the pre-reactivation script is executed upon the detection of an error
Execute Script before Failover:	Whether the pre-failover script is executed upon the detection of an error
Execute Script before Final Action:	Whether the pre-final-action script is executed upon the detection of an error
Recovery Target:	Target to be recovered when an error is detected
Recovery Target Type:	Type of target to be recovered when an error is detected
Recovery Script Threshold:	The number of times the recovery script is executed upon the detection of an error
Reactivation Threshold:	The number of reactivations to be made at detection of an error
Failover Target Server:	Determination method of Failover Target Server
Failover Threshold:	The number of failovers to be made at detection of an error
Wait Time to Start Monitoring (sec):	Time to wait before starting of monitoring (in seconds)
Dummy Failure Possibility:	Possibility of Dummy Failure
Collect Dump at Timeout Occurrence:	Whether or not dump of monitor process is collected when timeout occurs
Run Migration Before Run Failover:	Whether or not migration is run before running failover

Understanding disk TUR monitor resources

Disk TUR monitor resources monitor the disk specified by disk resource.

Notes on disk TUR monitor resources

- You cannot run the SISI Test Unit Ready command on a disk or disk interface (HBA) that does not support it. Even if your hardware supports this command, consult the driver specifications because the driver may not support it.
- TUR monitor resources, compared to disk RW monitor resources, burdens OS and disks less.
- In some cases, Test Unit Ready may not be able to detect actual errors in I/O to media.
- If you want multipath software to initiate path failover when disk path is not connected, you should set longer timeout for disk RW monitor resource than path failover time.
- This monitor resource is automatically registered when a disk resource is added. A disk TUR monitor resource corresponding to a disk resource is automatically registered.
Disk TUR monitor resources are initially defaulted, so configure appropriate resource settings as needed.

Displaying and changing the disk TUR monitor resource details

1. Click **Monitors** on the tree view displayed on the left side of the Builder window.
2. List of the monitor resources is displayed in the table view on the right side of the screen. Right click the target disk TUR monitor resource, and click the **Monitor(special)** tab in the **Monitor Resource Property** window.
3. On the **Monitor(special)** tab, you can display and/or change the detailed settings by following the description below.

Disk TUR monitor resource Monitor(special) tab

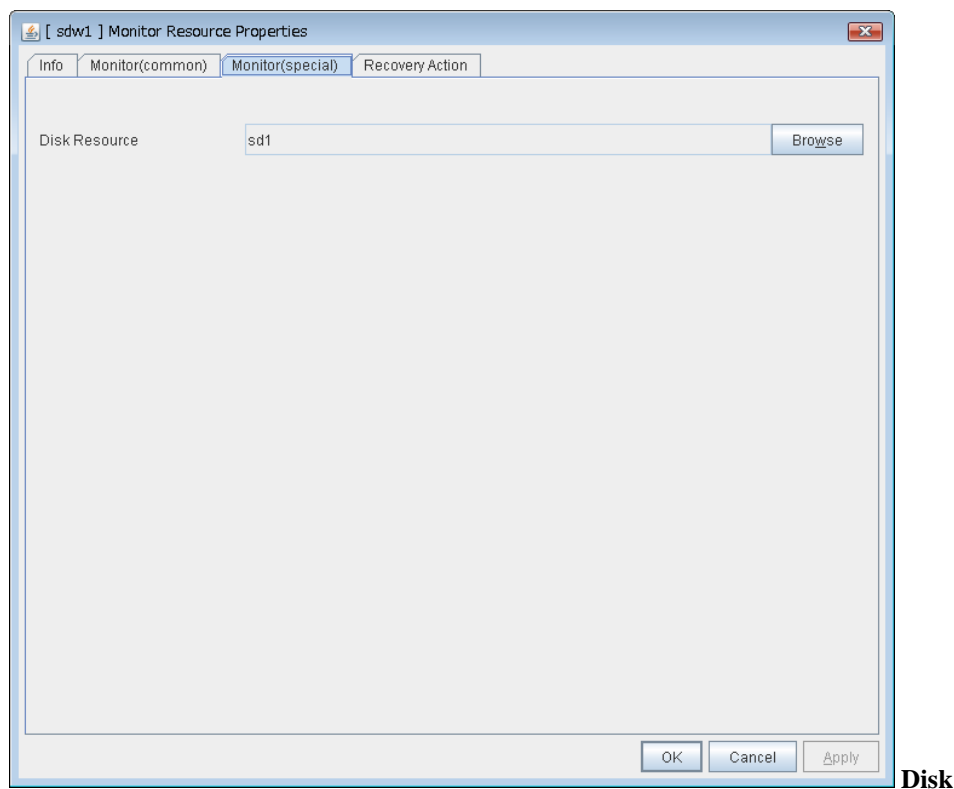

Resource **Suspend/Resume**

Select a disk resource.

Browse

Click this button to display the disk resources that can be registered.

Disk TUR monitor resource: disk resource selection properties

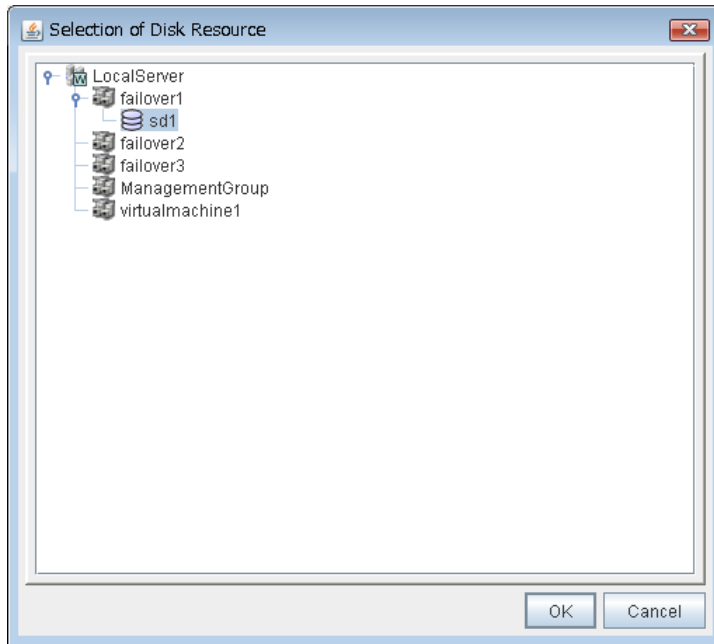

Displaying the disk TUR monitor resources properties with the WebManager

1. Start the WebManager (*http://Management IP address or the IP address of the cluster server: port_number* (the default value is 29003)).
2. Click a TUR monitor resources object, , in the tree view. The following information is displayed in the list view.

Disk TUR Monitor Name: sdw1		Details
Common server1 server2		
Properties	Value	
Comment		
Disk Resource	sd1	
Status	Normal	
Resource Status on Each Server		
Server Name	Status	
server1	Normal	
server2	Normal	

Comment: Comment of the disk TUR monitor resource
 Disk Resource: Disk resource to be monitored.
 Status: Disk TUR monitor resource status

Resource Status on Each Server

Server Name: Server name of each server
 Status: Status of the monitor resource status on the given server

When you click **Details**, the following information is displayed in the pop-up dialog box.

Properties	Value
Name	sdw1
Type	sdw
Monitor Timing	Always
Target Resource	
Interval	30
Timeout	300
Do Not Retry at Timeout Occurrence	Off
Do Not Execute Recovery Action at Timeout Occurrence	Off
Retry Count	1
Final Action	No operation
Execute Script Before Reactivation	Off
Execute Script Before Failover	Off
Execute Script before Final Action	Off
Recovery Target	sd1
Recovery Target Type	Resource
Recovery Script Threshold	0
Reactivation Threshold	0
Failover Target Server	Stable Server
Failover Threshold	Number of Servers
Wait Time to Start Monitoring	0
Dummy Failure Possibility	Possible
Collect Dump at Timeout Occurrence	Off
Run Migration Before Run Failover	Off

Name:	Disk TUR monitor resource name
Type:	Monitor resource type
Monitor Timing:	Timing for the monitor resource to start monitoring
Target Resource:	Resource to be monitored
Interval (sec):	Interval between monitoring (in seconds)
Timeout (sec):	Timeout for monitoring (in seconds)
Do Not Retry at Timeout Occurrence:	Whether or not to retry when timeout occurs
Do Not Execute Recovery Action at Timeout Occurrence:	Whether or not to execute recovery action when timeout occurs
Retry Count:	The number of retries to be made from detection of an error in the monitor target to establish the monitor resource as error
Final Action:	Final action at detection of an error
Execute Script before Reactivation:	Whether the pre-reactivation script is executed upon the detection of an error
Execute Script before Failover:	Whether the pre-failover script is executed upon the detection of an error
Execute Script before Final Action:	Whether the pre-final-action script is executed upon the detection of an error
Recovery Target:	Target to be recovered when an error is detected
Recovery Target Type:	Type of target to be recovered when an error is detected
Recovery Script Threshold:	The number of times the recovery script is executed upon the detection of an error
Reactivation Threshold:	The number of reactivations to be made at detection of an error
Failover Target Server:	Determination method of Failover Target Server
Failover Threshold:	The number of failovers to be made at detection of an error
Wait Time to Start Monitoring (sec):	Time to wait before starting of monitoring (in seconds)
Dummy Failure Possibility:	Possibility of Dummy Failure
Collect Dump at Timeout Occurrence:	Whether or not dump of monitor process is collected when timeout occurs
Run Migration Before Run Failover:	Whether or not migration is run before running failover

Understanding service monitor resources

Service monitor resources monitor service resources.

Monitoring by service monitor resources

Service monitor resources monitor service resources in a server where they are activated. They regularly check the service status with the service control manager and if the status of the service resource becomes Stopped, it is considered as an error.

Note on service monitor resources

- This monitor resource is automatically registered when a service resource is added. A service monitor resource corresponding to a service resource is automatically registered. Service monitor resources are initially defaulted, so configure appropriate resource settings as needed.

Displaying and changing the details of the service monitor resources

There is no detailed setting to be made for service monitor resources.

Displaying the service monitor resources properties with the WebManager

1. Start the WebManager (*http://Management IP address or the IP address of the cluster server: port_number* (the default value is 29003)).
2. Click a service monitor resources object, , in the tree view. The following information is displayed in the list view.

Service Monitor Name: servicew1		Details
<div style="display: flex; border-bottom: 1px solid black;"> Common server1 server2 </div>		
Properties	Value	
Comment		
Status	Normal	
Resource Status on Each Server		
Server Name	Status	
server1	Normal	
server2	Offline	

Comment: Comment of the service monitor resource
 Status: Service monitor resource status

Resource Status on Each Server
 Server Name: Server name of each server
 Status: Status of the monitor resource status on the given server

When you click **Details**, the following information is displayed in the pop-up dialog box.

Properties	Value
Name	servicew1
Type	servicew
Monitor Timing	Activating
Target Resource	service1
Interval	60
Timeout	60
Do Not Retry at Timeout Occurrence	Off
Do Not Retry at Timeout Occurrence	Off
Retry Count	1
Final Action	No operation
Execute Script Before Reactivation	Off
Execute Script Before Failover	Off
Execute Script before Final Action	Off
Recovery Target	service1
Recovery Target Type	Resource
Recovery Script Threshold	0
Reactivation Threshold	3
Failover Target Server	Stable Server
Failover Threshold	Number of Servers
Wait Time to Start Monitoring	0
Dummy Failure Possibility	Possible
Collect Dump at Timeout Occurrence	Off
Run Migration Before Run Failover	Off

Name: Service monitor resource name
 Type: Monitor resource type
 Monitor Timing: Timing for the monitor resource to start monitoring
 Target Resource: Resource to be monitored

Interval (sec):	Interval between monitoring (in seconds)
Timeout (sec):	Timeout for monitoring (in seconds)
Do Not Retry at Timeout Occurrence:	Whether or not to retry when timeout occurs
Do Not Execute Recovery Action at Timeout Occurrence:	Whether or not to execute recovery action when timeout occurs
Retry Count:	The number of retries to be made from detection of an error in the monitor target to establish the monitor resource as error
Final Action:	Final action at detection of an error
Execute Script before Reactivation:	Whether the pre-reactivation script is executed upon the detection of an error
Execute Script before Failover:	Whether the pre-failover script is executed upon the detection of an error
Execute Script before Final Action:	Whether the pre-final-action script is executed upon the detection of an error
Recovery Target:	Target to be recovered when an error is detected
Recovery Target Type:	Type of target to be recovered when an error is detected
Recovery Script Threshold:	The number of times the recovery script is executed upon the detection of an error
Reactivation Threshold:	The number of reactivations to be made at detection of an error
Failover Target Server:	Determination method of Failover Target Server
Failover Threshold:	The number of failovers to be made at detection of an error
Wait Time to Start Monitoring (sec):	Time to wait before starting of monitoring (in seconds)
Dummy Failure Possibility:	Possibility of Dummy Failure
Collect Dump at Timeout Occurrence:	Whether or not dump of monitor process is collected when timeout occurs
Run Migration Before Run Failover:	Whether or not migration is run before running failover

Understanding print spooler monitor resources

Print spooler monitor resources monitor print spooler resources. They regularly check the spooler service status with the service control manager and if the status of the print spooler monitor resource becomes Stopped, it is considered as an error.

Note on print spooler monitor resources

- This monitor resource is automatically registered when a print spooler resource is added. A print spooler monitor resource corresponding to a print spooler resource is automatically registered. Print spooler monitor resources are initially defaulted, so configure appropriate resource settings as needed.

Displaying and changing the details of the print spooler monitor resources

There is no detailed setting to be made for print spooler monitor resources.

Displaying the print spooler monitor resources properties with the WebManager

- Start the WebManager (*http://Management IP address or the IP address of the cluster server: port_number* (the default value is 29003)).
- Click a print spooler monitor resources object, , in the tree view. The following information is displayed in the list view.

Print Spooler Monitor Name: spoolw1		Details
Common server1 server2		
Properties	Value	
Comment		
Status	Normal	
Resource Status on Each Server		
Server Name	Status	
server1	Normal	
server2	Offline	

Comment: Comment of the print spooler monitor resource

Status: Print spooler monitor resource status

Resource Status on Each Server

Server Name: Server name of each server

Status: Status of the monitor resource status on the given server

When you click **Details**, the following information is displayed in the pop-up dialog box.

Properties	Value
Name	spoolw1
Type	spoolw
Monitor Timing	Activating
Target Resource	spool1
Interval	60
Timeout	60
Do Not Retry at Timeout Occurrence	Off
Do Not Execute Recovery Action at Timeout Occurrence	Off
Retry Count	1
Final Action	No operation
Execute Script Before Reactivation	Off
Execute Script Before Failover	Off
Execute Script before Final Action	Off
Recovery Target	spool1
Recovery Target Type	Resource
Recovery Script Threshold	0
Reactivation Threshold	3
Failover Target Server	Stable Server
Failover Threshold	Number of Servers
Wait Time to Start Monitoring	0
Dummy Failure Possibility	Possible
Collect Dump at Timeout Occurrence	Off
Run Migration Before Run Failover	Off

- Name: Print spooler monitor resource name
- Type: Monitor resource type
- Monitor Timing: Timing for the monitor resource to start monitoring
- Target Resource: Resource to be monitored
- Interval (sec): Interval between monitoring (in seconds)
- Timeout (sec): Timeout for monitoring (in seconds)
- Do Not Retry at Timeout Occurrence: Whether or not to retry when timeout occurs
- Do Not Execute Recovery Action at Timeout Occurrence: Whether or not to execute recovery action when timeout occurs
- Retry Count: The number of retries to be made from detection of an error in the monitor target to establish the monitor resource as error
- Final Action: Final action at detection of an error
- Execute Script before Reactivation: Whether the pre-reactivation script is executed upon the detection of an error
- Execute Script before Failover: Whether the pre-failover script is executed upon the detection of an error
- Execute Script before Final Action: Whether the pre-final-action script is executed upon the detection of an error
- Recovery Target: Target to be recovered when an error is detected
- Recovery Target Type: Type of target to be recovered when an error is detected
- Recovery Script Threshold: The number of times the recovery script is executed upon the detection of an error
- Reactivation Threshold: The number of reactivations to be made at detection of an error
- Failover Target Server: Determination method of Failover Target Server
- Failover Threshold: The number of failovers to be made at detection of an error
- Wait Time to Start Monitoring (sec): Time to wait before starting of monitoring (in seconds)
- Dummy Failure Possibility: Possibility of Dummy Failure
- Collect Dump at Timeout Occurrence: Whether or not dump of monitor process is collected when timeout occurs
- Run Migration Before Run Failover: Whether or not migration is run before running failover

Understanding virtual computer name monitor resources

Virtual computer name monitor resources monitor virtual computer name resources.

Monitoring by virtual computer name monitor resources

Virtual computer name monitor resources monitor virtual computer name resources in a server where they are activated. Virtual computer name monitor resources regularly check the virtual computer name control process. It is considered an error if the process is not found.

Virtual computer name monitor resource

- This monitor resource is automatically registered when the virtual computer name resource is added.
- The effective final actions when an error in this resource is detected is set to **Stop the cluster service and shutdown OS, Stop the cluster service and reboot OS** and **Generating of intentional Stop Error** only. This is because the OS reboot is required for correctly activating virtual computer name resource when virtual computer name control process disappeared. The default is **Stop the cluster service and shutdown OS**. If the virtual computer name control process is not found, the group fails over by shutting down or rebooting the server that detected an error.

Displaying and changing the details of the virtual computer name resources

There is no detailed setting to be made for virtual computer name monitor resources.

Displaying the virtual computer name monitor resource properties with the WebManager

1. Start the WebManager (*http://Management IP address or the IP address of the cluster server: port_number* (the default value is 29003)).
2. Click a virtual computer name monitor resource object, , in the tree view. The following information is displayed in the list view.

Virtual Computer Name Monitor Name: vcomw1		Details
Common		
Properties		Value
Comment		
Status		Normal
Resource Status on Each Server		
Server Name	Status	
server1	Normal	
server2	Offline	

Comment: Comment of the virtual computer name monitor resource

Status: Status of the virtual computer name monitor resource

Resource Status on Each Server

Server Name: Server name of each server

Status: Status of the monitor resource status on the given server

When you click **Details**, the following information is displayed in the pop-up dialog box.

Properties	Value
Name	vcomw1
Type	vcomw
Monitor Timing	Activating
Target Resource	vcom1
Interval	60
Timeout	60
Do Not Retry at Timeout Occurrence	Off
Do Not Retry at Timeout Occurrence	Off
Retry Count	1
Final Action	Stop the cluster service and shutdown OS
Execute Script Before Reactivation	Off
Execute Script Before Failover	Off
Execute Script before Final Action	Off
Recovery Target	LocalServer
Recovery Target Type	Itself
Recovery Script Threshold	0
Reactivation Threshold	0
Failover Target Server	Stable Server
Failover Threshold	0
Wait Time to Start Monitoring	0
Dummy Failure Possibility	Possible
Collect Dump at Timeout Occurrence	Off
Run Migration Before Run Failover	Off

Name: Virtual computer name monitor resource name

Type: Monitor resource type

Monitor Timing: Timing for the monitor resource to start monitoring

Target Resource: Resource to be monitored

Interval (sec): Interval between monitoring (in seconds)

Timeout (sec):	Timeout for monitoring (in seconds)
Do Not Retry at Timeout Occurrence:	Whether or not to retry when timeout occurs
Do Not Execute Recovery Action at Timeout Occurrence:	Whether or not to execute recovery action when timeout occurs
Retry Count:	The number of retries to be made from detection of an error in the monitor target to establish the monitor resource as error
Final Action:	Final action at detection of an error
Execute Script before Reactivation:	Whether the pre-reactivation script is executed upon the detection of an error
Execute Script before Failover:	Whether the pre-failover script is executed upon the detection of an error
Execute Script before Final Action:	Whether the pre-final-action script is executed upon the detection of an error
Recovery Target:	Target to be recovered when an error is detected
Recovery Target Type:	Type of target to be recovered when an error is detected
Recovery Script Threshold:	The number of times the recovery script is executed upon the detection of an error
Reactivation Threshold:	The number of reactivations to be made at detection of an error
Failover Target Server:	Determination method of Failover Target Server
Failover Threshold:	The number of failovers to be made at detection of an error
Wait Time to Start Monitoring (sec):	Time to wait before starting of monitoring (in seconds)
Dummy Failure Possibility:	Possibility of Dummy Failure
Collect Dump at Timeout Occurrence:	Whether or not dump of monitor process is collected when timeout occurs
Run Migration Before Run Failover:	Whether or not migration is run before running failover

Understanding dynamic DNS monitor resources

Notes on dynamic DNS monitor resources

There are no detailed settings related to dynamic DNS monitor resources. Use them when using dynamic DNS resources of EXPRESSCLUSTER.

- ◆ Dynamic DNS monitor resources are automatically created when dynamic DNS resources are added. One dynamic DNS monitor resource is automatically created per dynamic DNS resource.
- ◆ Dynamic DNS monitor resources cannot be deleted. When dynamic DNS resources are deleted, dynamic DNS monitor resources are automatically deleted.
- ◆ Do not change the recovery target.
- ◆ Monitoring cannot be suspended or resumed using the `clpmonctrl` command or WebManager.
- ◆ If the target dynamic DNS resource is active when the cluster is suspended, the dynamic DNS monitor resource continues to operate without stopping.
- ◆ Alive monitoring is performed for a DDNS control process (`clpddnsp.exe`) periodically. If a disappearance of the process is detected, it is determined that an error has occurred. The alive monitoring interval is specified in **Interval** of the **Monitor (common)** tab. If the **Execute Dynamic Update Periodically** check box of the dynamic DNS resource **Details** tab is not selected, a DDNS control process (`clpddnsp.exe`) is generated, but alive monitoring is not performed.
- ◆ When the DNS server is down, a failover may start depending on the configuration. Therefore, it is recommended to use IP monitor resources together when checking the connection to the DNS server.
- ◆ In internal version of the software is 11.31 or earlier, Dynamic DNS monitor resources monitor the ping response from the virtual hostname registered by Dynamic DNS resources at the intervals of time set in Monitor Interval. If there is no response, Dynamic DNS monitor resources wait for a response for 30 minutes (monitoring interval: six seconds, monitor retry count: 300). This setting cannot be changed. If ICMP Echo Request is blocked in the firewall setting, the monitoring of ping response fails and monitoring error occurs. In such a case, perform one of the following:
 - Accept the ICMP echo request.
 - Use internal version 11.32 or later which employs DNS query packets to monitor a response.

Displaying and changing the details of the dynamic DNS monitor resource

1. In the tree view shown on the left pane of the Builder, click the **Monitors** icon.
2. A list of monitor resources is shown in the table view on the right side of the screen. Right-click the target dynamic DNS monitor resource name, and click **Properties**, and then click the **Monitor(special)** tab.
3. On the **Monitor(special)** tab, you can see and/or change the detailed settings as described below.

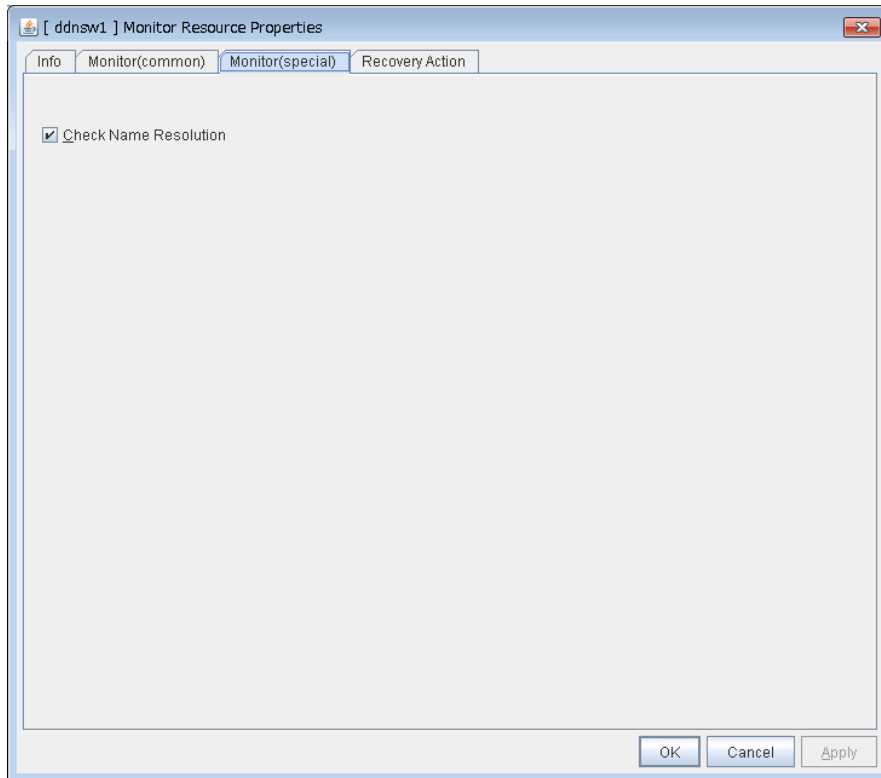

Check Name Resolution Suspend/Resume

- When the check box is selected (default):
Check whether name resolution is available by sending a DNS query packet to the DNS server.
- When the check box is not selected:
Do not check whether name resolution is available.

Displaying dynamic DNS monitor resource properties with WebManager

1. Start the WebManager (*http://Management IP address or the IP address of the cluster server: port_number* (the default value is 29003)).
2. Click a dynamic DNS monitor resource object, , in the tree view. The following information is displayed in the list view.

Dynamic DNS Monitor: ddnsw1		Details
<div style="display: flex; justify-content: space-between; border-bottom: 1px solid gray;"> Common server1 server2 </div>		
Properties	Value	
Comment		
Monitor Target	ddns1	
Status	Normal	
Resource Status on Each Server		
Server Name	Status	
server1	Normal	
server2	Offline	

Comment
Status

Comment of the dynamic DNS monitor resource
Status of the dynamic DNS monitor resource

Failover Target Server	Method of determining the failover target server
Failover Threshold	Number of failovers to be made upon detection of an error
Wait Time to Start Monitoring (sec)	Time to wait before starting the monitoring (in seconds)
Dummy Failure Possibility	Possibility of dummy failure
Collect Dump at Timeout Occurrence	Whether or not the dump of the monitor process is collected when a timeout occurs
Run Migration Before Run Failover	Whether or not migration is run before running
DNS query check	Whether or not to ask the DNS server if name resolution is available.

Understanding virtual IP monitor resources

Virtual IP monitor resources monitor virtual IP resources.

Monitoring by virtual IP monitor resources

Virtual IP monitor resources monitor virtual IP resources in a server where they are activated. Virtual IP monitor resources monitor whether the virtual IP address exists in the list of IP addresses. If the virtual IP address does not exist, it is considered as an error.

Floating IP resources monitor link up/down of NIC where a virtual floating IP address is active. If NIC link down is detected, it is considered as an error.

Windows Server 2008 R2 or earlier uses the DeviceIoControl function, and depending on the NIC driver, the necessary DeviceIoControl function may not be supported. In this case, this setting cannot be used.

Windows Server 2012 or later uses WMI, and this setting can be used.

Notes on virtual IP monitor resources

- This resource is automatically registered when virtual IP resources are added.

Displaying and changing the details of the virtual IP monitor resources

There is no detailed setting to be made for virtual IP monitor resources.

Displaying the virtual IP monitor resource properties with the WebManager

1. Start the WebManager (*http://Management IP address or the IP address of the cluster server: port_number* (the default value is 29003)).
2. Click a virtual IP monitor resource object, , in the tree view. The following information is displayed in the list view.

Virtual IP Monitor Name: vipw1		Details
Common server1 server2		
Properties	Value	
Comment		
Status	Normal	
Resource Status on Each Server		
Server Name	Status	
server1	Normal	
server2	Offline	

Comment: Comment of the virtual IP monitor resource
 Status: Status of the virtual IP monitor resource

Resource Status on Each Server

Server Name: Server name of each server

Status: Status of the monitor resource on the given server

When you click **Details**, the following information is displayed in the pop-up dialog box.

Properties	Value
Name	vipw1
Type	vipw
Monitor Timing	Activating
Target Resource	vip1
Interval	60
Timeout	60
Do Not Retry at Timeout Occurrence	Off
Do Not Execute Recovery Action at Timeout Occurrence	Off
Retry Count	1
Final Action	No operation
Execute Script Before Reactivation	Off
Execute Script Before Failover	Off
Execute Script before Final Action	Off
Recovery Target	vip1
Recovery Target Type	Resource
Recovery Script Threshold	0
Reactivation Threshold	3
Failover Target Server	Stable Server
Failover Threshold	Number of Servers
Wait Time to Start Monitoring	0
Dummy Failure Possibility	Possible
Collect Dump at Timeout Occurrence	Off
Run Migration Before Run Failover	Off

Name:	Virtual IP monitor resource name
Type:	Monitor resource type
Monitor Timing:	Timing for the monitor resource to start monitoring
Target Resource:	Resource to be monitored
Interval (sec):	Interval between monitoring (in seconds)
Timeout (sec):	Timeout for monitoring (in seconds)
Do Not Retry at Timeout Occurrence:	Whether or not to retry when timeout occurs
Do Not Execute Recovery Action at Timeout Occurrence:	Whether or not to execute recovery action when timeout occurs
Retry Count:	The number of retries to be made from detection of an error in the monitor target to establish the monitor resource as error
Final Action:	Final action at detection of an error
Execute Script before Reactivation:	Whether the pre-reactivation script is executed upon the detection of an error
Execute Script before Failover:	Whether the pre-failover script is executed upon the detection of an error
Execute Script before Final Action:	Whether the pre-final-action script is executed upon the detection of an error
Recovery Target:	Target to be recovered when an error is detected
Recovery Target Type:	Type of target to be recovered when an error is detected
Recovery Script Threshold:	The number of times the recovery script is executed upon the detection of an error
Reactivation Threshold:	The number of reactivations to be made at detection of an error
Failover Target Server:	Determination method of Failover Target Server
Failover Threshold:	The number of failovers to be made at detection of an error
Wait Time to Start Monitoring (sec):	Time to wait before starting of monitoring (in seconds)
Dummy Failure Possibility:	Possibility of Dummy Failure
Collect Dump at Timeout Occurrence:	Whether or not dump of monitor process is collected when timeout occurs
Run Migration Before Run Failover:	Whether or not migration is run before running failover

Understanding CIFS monitor resources

CIFS monitor resources monitor CIFS resources.

Monitoring by CIFS monitor resources

CIFS resources monitor CIFS resources in a server where they are activated.

CIFS monitor resources obtain the information of shared folders publicized on a server and monitor if the shared folders publicized by CIFS resources are contained. An error is detected when the shared folders publicized by CIFS resources do not exist.

CIFS monitor resources also monitor accessibility to the shared folders.

When auto-saving of shared configuration of drive is executed, activation monitoring of the function to share and save the shared configuration is also be executed.

Notes on CIFS monitor resources

- When access check needs to be performed, the specified access method must be permitted for the local system account in the CIFS resources to be monitored.
- When **Execute the automatic saving of shared configuration of drive** is configured and not specify shared folder name to **path** on the monitoring target CIFS resource and the access check is executed on CIFS monitor resource, the specified access as a check method is executed on all the shared folder of the auto-saving target drive. When **Read** of folder check/file check is specified as checking method, the folder/file specified on **Path** must be on each shared folder.
- This monitor resource is automatically registered when a CIFS resource is added. A CIFS monitor resource corresponding to a CIFS resource is automatically registered. The default value is set for CIFS monitor resources. Change it to an appropriate value as needed.

Displaying and changing the details of CIFS monitor resources

1. From the tree view displayed on the left pane of the Builder. Click **Monitors**.
2. The monitor resources list is displayed on the table view in the right of the window. Right-click the desired CIFS monitor resource name, and click **Properties**. In the properties dialog box, click the **Monitor(special)** tab.
3. Display and/or change the detailed settings on the **Monitor(special)** tab.

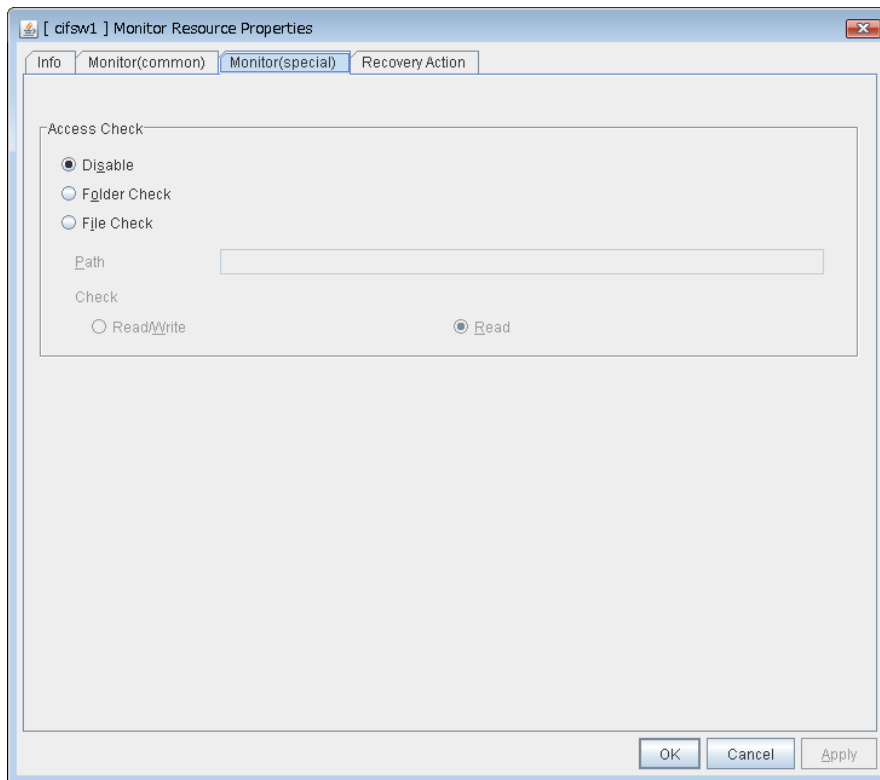

Access Check **SuspendResume**

Specify the way to check access to the shared folders.

- Disable (default)
Access check is not performed.
- Folder Check
Check if you can refer to the folder specified in **Path**.
- File Check
Check if reading and writing to the file specified in **Path** can be performed.

Path (Within 256 bytes) **SuspendResume**

Specify the file/folder for access check by using a path including the shared folder or a relative path from the shared folder.

For folder check, specify the folder in the shared folder.

When **Execute the automatic saving of shared configuration of drive** is configured for the target CIFS resource and specifying a path including shared folder, Only specified shared name file/folder need to be created, use the format "<shared-name>\folder-name/file-name". Surround a shared name with "<>".

When **Execute the automatic saving of shared configuration of drive** is configured to the target CIFS resource and a relative path from the shared folder is used for specifying the resource, folders with the same name need to be created in advance on all folders for which the sharing setting is configured.

When **Read/Write** is selected as a file check method, the specified file is newly created. Make sure to specify a file name that does not overlap with other file names.

When **Read** is selected a file check method, specify a file in the shared folder. When **Execute the automatic saving of shared configuration of drive** is configured to the target CIFS resource, files with the same name need to be created in advance on all folders for which the sharing setting is configured.

Check **SuspendResume**

Select the way to check the access for **File Check**.

- Read/Write (default value)
 - Write data to the file and check it can be read.
- Read
 - Open the files and check it can be read.

Displaying CIFS monitor resource properties with the WebManager

1. Start the WebManager (http://Management IP address or the IP address of the cluster server: port_number (the default value is 29003)).
2. Click a CIFS monitor resource object, , in the tree view. The following information is displayed in the list view.

CIFS Monitor Name: cifsw1		Details
Common server1 server2		
Properties	Value	
Comment		
Status	Normal	
Resource Status on Each Server		
Server Name	Status	
server1	Normal	
server2	Offline	

Comment: Comment of CIFS monitor resource
 States: Normal

Resource Status on Each Server

Server name: Server name of each server
 Status: Status of monitor resource on the given server

When you click **Details**, the following information is displayed in the pop-up dialog box.

Properties	Value
Name	cifsw1
Type	cifsw
Monitor Timing	Activating
Target Resource	cifs1
Interval	60
Timeout	60
Do Not Retry at Timeout Occurrence	Off
Do Not Retry at Timeout Occurrence	Off
Retry Count	1
Final Action	No operation
Execute Script Before Reactivation	Off
Execute Script Before Failover	Off
Execute Script before Final Action	Off
Recovery Target	cifs1
Recovery Target Type	Resource
Recovery Script Threshold	0
Reactivation Threshold	3
Failover Target Server	Stable Server
Failover Threshold	Number of Servers
Wait Time to Start Monitoring	0
Dummy Failure Possibility	Possible
Collect Dump at Timeout Occurrence	Off
Run Migration Before Run Failover	Off
Access Check	no check
Check Path	
Check Method	Read

Name: CIFS monitor resource name
 Type: Monitor resource type
 Monitor Timing: Timing for the monitor resource to start monitoring
 Target Resource: Resource to be monitored

Interval (sec):	Interval between monitoring (in seconds)
Timeout (sec):	Timeout for monitoring (in seconds)
Do Not Retry at Timeout Occurrence:	Whether or not to retry when timeout occurs
Do Not Execute Recovery Action at Timeout Occurrence:	Whether or not to execute recovery action when timeout occurs
Retry Count:	The number of retries to be made from detection of an error in the monitor target to establish the monitor resource as error
Final Action:	Final action at detection of an error
Execute Script before Reactivation:	Whether the pre-reactivation script is executed upon the detection of an error
Execute Script before Failover:	Whether the pre-failover script is executed upon the detection of an error
Execute Script before Final Action:	Whether the pre-final-action script is executed upon the detection of an error
Recovery Target:	Target to be recovered when an error is detected
Recovery Target Type:	Type of target to be recovered when an error is detected
Recovery Script Threshold:	The number of times the recovery script is executed upon the detection of an error
Reactivation Threshold:	The number of reactivations to be made at detection of an error
Failover Target Server:	Determination method of Failover Target Server
Failover Threshold:	The number of failovers to be made at detection of an error
Wait Time to Start Monitoring (sec):	Time to wait before starting of monitoring (in seconds)
Dummy Failure Possibility:	Possibility of Dummy Failure
Collect Dump at Timeout Occurrence:	Whether or not dump of monitor process is collected when timeout occurs
Run Migration Before Run Failover:	Whether or not migration is run before running failover
Access Check:	The way of checking the access
Check Path:	The path for the folders/files to be checked
Check Method:	The way of performing file check

Understanding NAS monitor resources

NAS monitor resources monitor NAS resources.

Monitoring by NAS monitor resources

NAS monitor resources monitor NAS resources in a server where they are activated.

Check that the network drive mounted by NAS resources is connected.

Note on NAS monitor resources

- This monitor resource is automatically registered when an NAS resource is added. A NAS monitor resource corresponding to an NAS resource is automatically registered. The default value is set for NAS monitor resources. Change it to an appropriate value as needed.
- If you succeed in the activation of an NAS resource but fail to monitor it, check that OS or NAS settings are correct by using the net view command.

Displaying and changing the details of NAS monitor resources

There is no detailed setting to be made for NAS monitor resources.

Displaying NAS monitor resources properties with the WebManager

1. Start the WebManager (http://Management IP address or the IP address of the cluster server:port_number (the default value is 29003)).
2. Click the NAS monitor resources object,  in the tree view. The following information is displayed in the list view.

NAS monitor Name: nasw1		Details
<div style="display: flex; border-bottom: 1px solid gray;"> Common server1 server2 </div>		
Properties	Value	
Comment		
Status	Normal	
Resource Status on Each Server		
Server Name	Status	
server1	Normal	
server2	Offline	

Comment: Comment of NAS monitor resource
 Status: Status of NAS monitor resource
 Resource Status on Each Server
 Server: Server name of each server
 Status: Status of monitor resource on the given server

When you click **Details**, the following information is displayed in the pop-up dialog box

Properties	Value
Name	nasw1
Type	nasw
Monitor Timing	Activating
Target Resource	nas1
Interval	60
Timeout	60
Do Not Retry at Timeout Occurrence	Off
Do Not Execute Recovery Action at Timeout Occurrence	Off
Retry Count	1
Final Action	No operation
Execute Script Before Reactivation	Off
Execute Script Before Failover	Off
Execute Script before Final Action	Off
Recovery Target	nas1
Recovery Target Type	Resource
Recovery Script Threshold	0
Reactivation Threshold	3
Failover Target Server	Stable Server
Failover Threshold	Number of Servers
Wait Time to Start Monitoring	0
Dummy Failure Possibility	Possible
Collect Dump at Timeout Occurrence	Off
Run Migration Before Run Failover	Off

- Name: NAS monitor resource name
- Type: Monitor resource type
- Monitor Timing: Timing for the monitor resource to start monitoring
- Target Resource: Resource to be monitored
- Interval (sec): Interval between monitoring (in seconds)
- Timeout (sec): Timeout for monitoring (in seconds)
- Do Not Retry at Timeout Occurrence: Whether or not to retry when timeout occurs
- Do Not Execute Recovery Action at Timeout Occurrence: Whether or not to execute recovery action when timeout occurs
- Retry Count: The number of retries to be made from detection of an error in the monitor target to establish the monitor resource as error
- Final Action: Final action at detection of an error
- Recovery Script Execution Count: The number of times the recovery script is executed upon the detection of an error
- Execute Script before Reactivation: Whether the pre-reactivation script is executed upon the detection of an error
- Execute Script before Failover: Whether the pre-failover script is executed upon the detection of an error
- Execute Script before Final Action: Whether the pre-final-action script is executed upon the detection of an error
- Recovery Target: Target to be recovered when an error is detected
- Recovery Target Type: Type of target to be recovered when an error is detected
- Recovery Script Threshold: The number of times the recovery script is executed upon the detection of an error
- Reactivation Threshold: The number of reactivations to be made at detection of an error
- Failover Target Server: Determination method of Failover Target Server
- Failover Threshold: The number of failovers to be made at detection of an error
- Wait Time to Start Monitoring (sec): Time to wait before starting of monitoring (in seconds)
- Dummy Failure Possibility: Possibility of Dummy Failure
- Collect Dump at Timeout Occurrence: Whether or not dump of monitor process is collected when timeout occurs
- Run Migration Before Run Failover: Whether or not migration is run before running failover

Understanding hybrid disk monitor resources

Hybrid disk monitor resources monitor a mirror partition device or mirror driver works properly.

Note on hybrid disk monitor resources

This resource is automatically registered when a hybrid disk resource is added. A hybrid disk monitor resource corresponding to the hybrid disk resource is automatically registered. When this resource is deleted, be careful that auto mirror recovery cannot be executed.

Refer to “Connecting mirror disks/hybrid disks manually Automatically recovering from mirroring” in “Chapter 11 Troubleshooting” in this guide for the details.

Displaying and changing the hybrid disk monitor resource details

1. Click **Monitors** on the tree view displayed on the left side of the Builder window.
2. List of the monitor resources is displayed in the table view on the right side of the screen. Right-click the target mirror disk monitor resource, and click the **Monitor(special)** tab in the **Monitor Resource Property** window.
3. On the **Monitor(special)** tab, you can display and/or change the detailed settings by following the description below.

Note:

Do not change the settings shown below on the **Error Detection** tab.

The Error Detection tab settings:

Recovery object	Hybrid disk resource name
Reactivation threshold	Zero (Never)
Failover Target Server	Stable operation server
Failover threshold	Set as many as the number of the servers
Final Action	No Operation

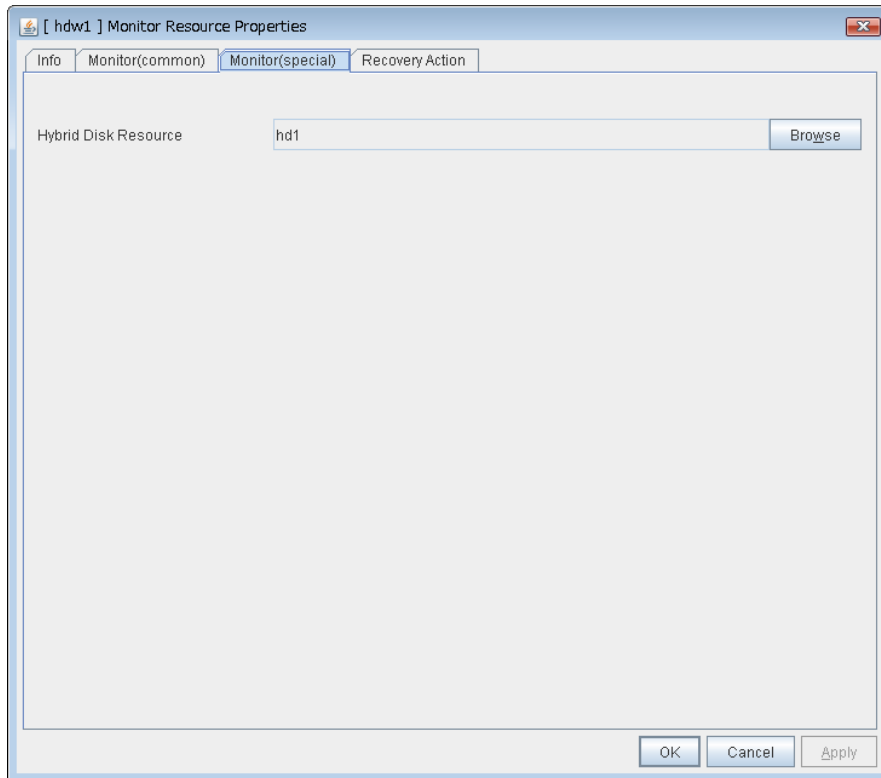

Hybrid Disk Resource SuspendResume

The hybrid disk resource to be monitored is displayed.

Browse

Click this button to display the dialog box where you can select a hybrid disk resource to be monitored. Hybrid disk resources registered with the cluster are displayed in a tree view. You can select only hybrid disk resources in this view. Select a hybrid disk resource and click **OK**.

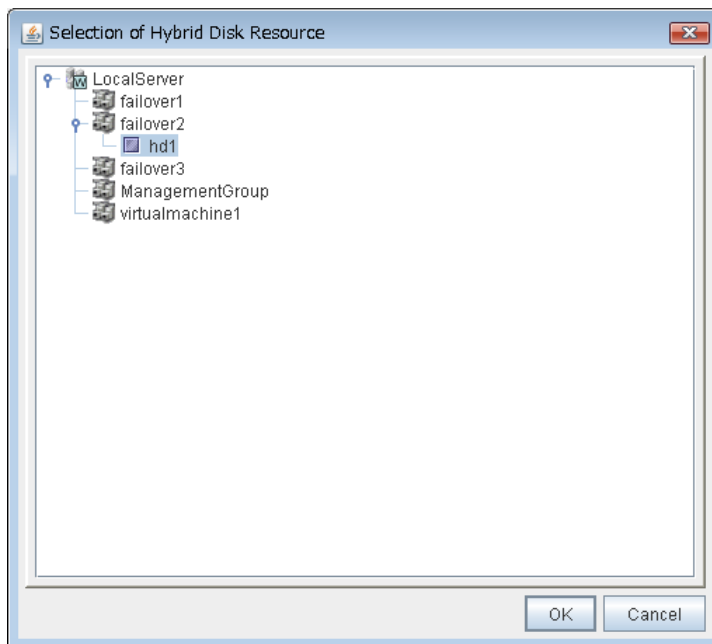

Displaying the hybrid disk monitor resource properties with the WebManager

1. Start the WebManager (*http://Management IP address or the IP address of the cluster server: port_number* (the default value is 29003)).
2. Click an object for a hybrid disk monitor resource, , in the tree view. The following information is displayed in the list view.

hybrid Disk Monitor Name: hdw1		Details	
Common		server1	server2
Properties	Value		
Comment			
Status	Normal		
Resource Status on Each Server			
Server Name	Status		
server1	Normal		
server2	Normal		

Name: Hybrid disk monitor resource name
 Comment: Comment of the hybrid disk monitor resource
 Status: Hybrid disk monitor resource status
 Resource Status on Each Server
 Server Name: Server name of each server
 Status: Status of the monitor resource on the given server

When you click **Details**, the following information is displayed in the pop-up dialog box.

Properties	Value
Name	hdw1
Type	hdw
Monitor Timing	Always
Target Resource	
Interval	30
Timeout	999
Do Not Retry at Timeout Occurrence	Off
Do Not Execute Recovery Action at Timeout Occurrence	Off
Retry Count	1
Final Action	No operation
Execute Script Before Reactivation	Off
Execute Script Before Failover	Off
Execute Script before Final Action	Off
Recovery Target	hd1
Recovery Target Type	Resource
Recovery Script Threshold	0
Reactivation Threshold	0
Failover Target Server	Stable Server
Failover Threshold	Number of Servers
Wait Time to Start Monitoring	10
Dummy Failure Possibility	Impossible
Collect Dump at Timeout Occurrence	Off
Run Migration Before Run Failover	Off

Name: Hybrid disk monitor resource name
 Type: Monitor resource type
 Monitor Timing: Timing for the monitor resource to start monitoring

Target Resource:	Resource to be monitored
Interval (sec):	Interval between monitoring (in seconds)
Timeout (sec):	Timeout for monitoring (in seconds)
Do Not Retry at Timeout Occurrence:	Whether or not to retry when timeout occurs
Do Not Execute Recovery Action at Timeout Occurrence:	Whether or not to execute recovery action when timeout occurs
Retry Count:	The number of retries to be made from detection of an error in the monitor target to establish the monitor resource as error.
Final Action:	Final action at detection of an error
Execute Script before Reactivation:	Whether the pre-reactivation script is executed upon the detection of an error
Execute Script before Failover:	Whether the pre-failover script is executed upon the detection of an error
Execute Script before Final Action:	Whether the pre-final-action script is executed upon the detection of an error
Recovery Target:	Target to be recovered when an error is detected
Recovery Target Type:	Type of target to be recovered when an error is detected
Recovery Script Threshold:	The number of times the recovery script is executed upon the detection of an error
Reactivation Threshold:	The number of reactivations to be made at detection of an error
Failover Target Server:	Determination method of Failover Target Server
Failover Threshold:	The number of failovers to be made at detection of an error
Wait Time to Start Monitoring (sec):	Time to wait before starting monitoring (in seconds)
Dummy Failure Possibility:	Possibility of Dummy Failure
Collect Dump at Timeout Occurrence:	Whether or not dump of monitor process is collected when timeout occurs
Run Migration Before Run Failover:	Whether or not migration is run before running failover

Understanding hybrid disk TUR monitor resources

Hybrid disk TUR monitor resources monitor the disk specified by hybrid disk resource.

Notes on hybrid disk TUR monitor resources

- This resource is automatically registered when a hybrid disk resource is added. Hybrid disk TUR monitor resources corresponding hybrid disk resources are automatically registered.
When this resource is deleted, be careful that auto mirror recovery cannot be executed.
Refer to “Connecting mirror disks/hybrid disks manually Automatically recovering from mirroring” in “Chapter 11 Troubleshooting” in this guide for the details.
- You cannot run the SISI Test Unit Ready command on a disk or disk interface (HBA) that does not support it. Even if your hardware supports this command, consult the driver specifications because the driver may not support it.
- TUR monitor resources, compared to disk RW monitor resources, burdens OS and disks less.
- In some cases, Test Unit Ready may not be able to detect actual errors in I/O to media.

Displaying and changing the hybrid disk TUR monitor resource details

1. Click **Monitors** on the tree view displayed on the left side of the Builder window.
2. List of the monitor resources is displayed in the table view on the right side of the screen. Right click the target disk TUR monitor resource, and click the **Monitor(special)** tab in the **Monitor Resource Property** window.
3. On the **Monitor(special)** tab, you can display and/or change the detailed settings by following the description below.

Note:

Do not change the settings shown below on the **Error Detection** tab.

The **Error Detection** tab settings:

Recovery object	Hybrid disk resource name
Reactivation threshold	Zero (Never)
Failover Target Server	Stable operation server
Failover threshold	Set as many as the number of the servers
Final Action	No Operation

Hybrid disk TUR monitor resource Monitor(special) tab

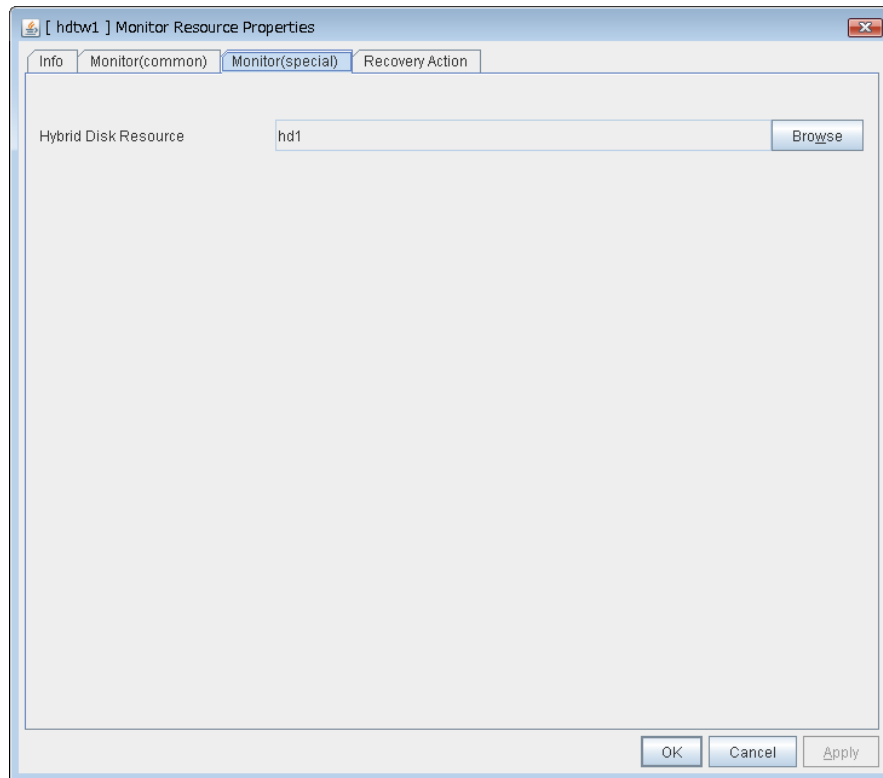

Hybrid Disk Resource SuspendResume

Select a hybrid disk resource.

Browse

Click this button to display the hybrid disk resources that can be registered.

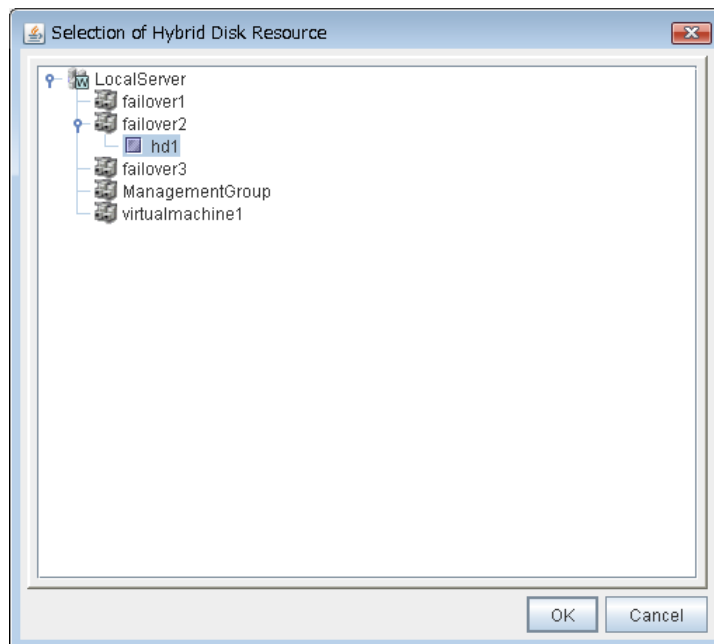

Displaying the hybrid disk TUR monitor resources properties with the WebManager

1. Start the WebManager (*http://Management IP address or the IP address of the cluster server: port_number* (the default value is 29003)).
2. Click a hybrid disk TUR monitor resources object, , in the tree view. The following information is displayed in the list view.

Hybrid-Disk TUR Monitor Name: hdtw1		Details
Common		
server1		
server2		
Properties	Value	
Comment		
Hybrid Disk Resource	hd1	
Status	Normal	
Resource Status on Each Server		
Server Name	Status	
server1	Normal	
server2	Normal	

Comment: Comment of the hybrid disk TUR monitor resource
 Hybrid Disk Resource: Hybrid disk resource to be monitored.
 Status Hybrid disk TUR monitor resource status
 Resource Status on Each Server
 Server Name: Server name of each server
 Status: Status of the monitor resource status on the given server

When you click **Details**, the following information is displayed in the pop-up dialog box.

Properties	Value
Name	hdtw1
Type	hdtw
Monitor Timing	Always
Target Resource	
Interval	30
Timeout	300
Do Not Retry at Timeout Occurrence	Off
Do Not Retry at Timeout Occurrence	Off
Retry Count	0
Final Action	No operation
Execute Script Before Reactivation	Off
Execute Script Before Failover	Off
Execute Script before Final Action	Off
Recovery Target	hd1
Recovery Target Type	Resource
Recovery Script Threshold	0
Reactivation Threshold	0
Failover Target Server	Stable Server
Failover Threshold	Number of Servers
Wait Time to Start Monitoring	10
Dummy Failure Possibility	Impossible
Collect Dump at Timeout Occurrence	Off
Run Migration Before Run Failover	Off

Name: Hybrid disk TUR monitor resource name
 Type: Monitor resource type
 Monitor Timing: Timing for the monitor resource to start monitoring
 Target Resource: Resource to be monitored

Interval (sec):	Interval between monitoring (in seconds)
Timeout (sec):	Timeout for monitoring (in seconds)
Do Not Retry at Timeout Occurrence:	Whether or not to retry when timeout occurs
Do Not Execute Recovery Action at Timeout Occurrence:	Whether or not to execute recovery action when timeout occurs
Retry Count:	The number of retries to be made from detection of an error in the monitor target to establish the monitor resource as error
Final Action:	Final action at detection of an error
Execute Script before Reactivation:	Whether the pre-reactivation script is executed upon the detection of an error
Execute Script before Failover:	Whether the pre-failover script is executed upon the detection of an error
Execute Script before Final Action:	Whether the pre-final-action script is executed upon the detection of an error
Recovery Target:	Target to be recovered when an error is detected
Recovery Target Type:	Type of target to be recovered when an error is detected
Recovery Script Threshold:	The number of times the recovery script is executed upon the detection of an error
Reactivation Threshold:	The number of reactivations to be made at detection of an error
Failover Target Server:	Determination method of Failover Target Server
Failover Threshold:	The number of failovers to be made at detection of an error
Wait Time to Start Monitoring (sec):	Time to wait before starting of monitoring (in seconds)
Dummy Failure Possibility:	Possibility of Dummy Failure
Collect Dump at Timeout Occurrence:	Whether or not dump of monitor process is collected when timeout occurs
Run Migration Before Run Failover:	Whether or not migration is run before running failover

Understanding custom monitor resources

Custom monitor resources monitor system by executing an arbitrary script.

Monitoring by custom monitor resources

Custom monitor resources monitor system by an arbitrary script.

When Monitor Type is **Synchronous**, custom monitor resources regularly run a script and detect errors from its error code.

When Monitor Type is **Asynchronous**, custom monitor resources run a script upon start monitoring and detect errors if the script process disappears.

Note on custom monitor resources

- ◆ When **Asynchronous** is selected as the monitor type and a monitor error occurs because the execution of the script has ended, the script is not re-executed.
Therefore, when Monitor Type is **Asynchronous**, set the monitoring retry count to zero.
- ◆ When a command for outputting a message (standard output, error output) in response to the prompt is executed as part of a batch file, the batch file may stop during execution of the command. Therefore, specify (perform redirection to) a file or `null` as the message output destination.

Displaying and changing the details of the custom monitoring resources

1. Click **Monitors** on the tree view displayed on the left side of the Builder window.
2. List of the monitor resources is displayed in the table view on the right side of the screen. Right click the target custom monitor resource, and click the **Monitor(special)** tab in the **Monitor Resource Property** window.
3. On the **Monitor(special)** tab, you can display and/or change the detailed settings by following the description below.

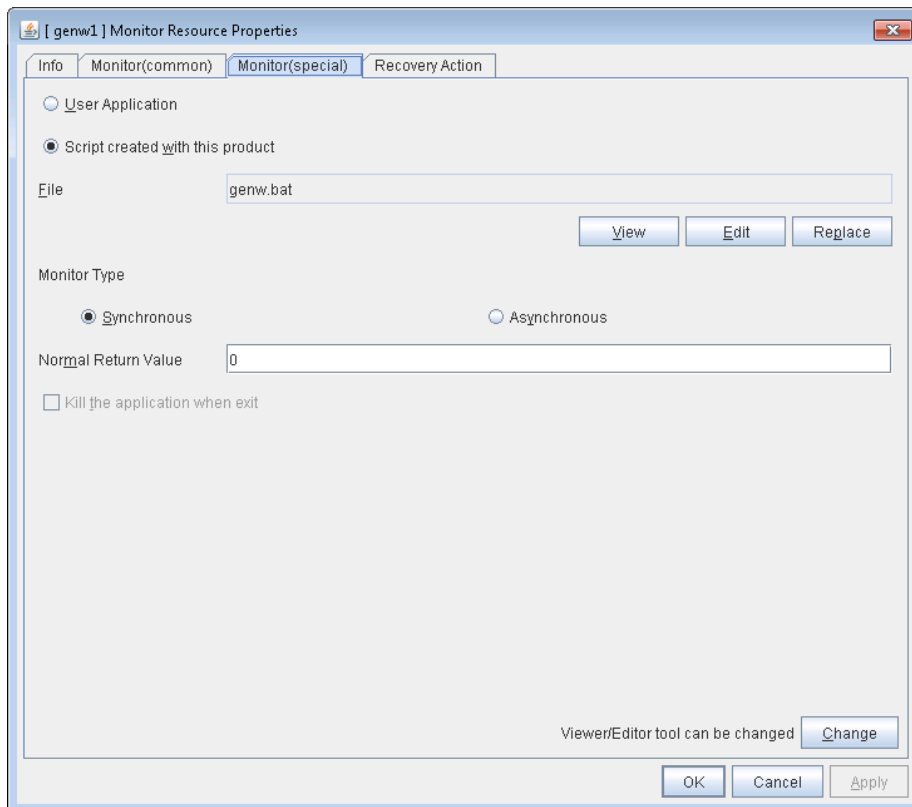

User Application **SuspendResume**

Use an executable file (executable batch file or execution file) on the server as a script. For the file name, specify an absolute path or name of the executable file of the local disk on the server.

Each executable files is not included in the cluster configuration information of the Builder. They must be prepared on each server because they cannot be edited nor uploaded by the Builder.

Script created with this product **SuspendResume**

Specify a script file which is prepared by the Builder as a script with an absolute path of local disk on server.

File (Within 1023 bytes)

Specify the script to be executed (executable shell script file or execution file) when you select User Application with its absolute path on the local disk of the server. However, no argument can be specified after the script.

View

Click here to display the script file with an editor when you select **Script created with this product**. The information edited and stored with the editor is not applied. You cannot display the script file if it is currently displayed or edited.

Edit

Click here to edit the script file with the editor when you select **Script created with this product**. Overwrite the script file to apply the change. You cannot edit the script file if it is currently displayed or edited. You cannot modify the name of the script file.

Replace

Click here to replace the contents of a script file with the contents of the script file which you selected in the file selection dialog box when you select **Script created with this product**. You cannot replace the script file if it is currently displayed or edited. Select a script file only. Do not select binary files (applications), and so on.

Change

Click here to display the **Change Script Editor** dialog. You can change editor for displaying or editing a script to an arbitrary editor.

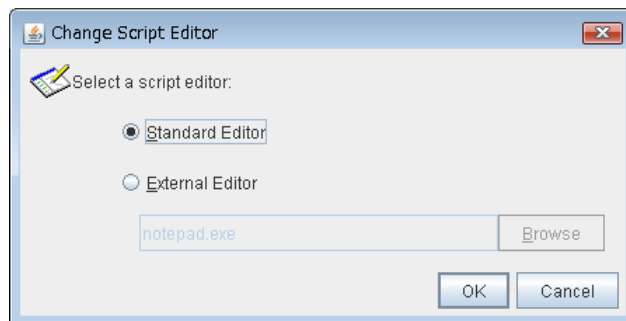

Standard Editor

Select here to use a standard editor (Notepad in Windows) as a script editor.

External Editor

Select here to specify an arbitrary script editor. Click **Browse** to specify the editor to be used.

Monitor Type **SuspendResume**

Select a monitor type.

- . Synchronous (Default)
 - Custom monitor resources regularly run a script and detect errors from its error code.
- . Asynchronous
 - Custom monitor resources run a script upon start monitoring and detect errors if the script process disappears.

Normal Return Value (Within 1023 bytes) **SuspendResume**

When **Asynchronous** is selected for **Monitor Type**, set the values of script error code to be determined as normal. If you want to set two or more values here, separate them by commas like 0,2,3 or connect them with a hyphen to specify the range like 0-3.

Default value: 0

Forcibly Terminate Application When Stopping

Specify whether or not to forcibly terminate the application as termination of monitoring stop. If this is selected, the application is forcibly terminated instead of normal termination. This is effective only when **Monitor Type** is set to **Asynchronous**.

Displaying the custom monitor resource properties with the WebManager

1. Start the WebManager (*http://Management IP address or the IP address of the cluster server: port_number* (the default value is 29003)).
2. Click a custom monitor resources object, , in the tree view. The following information is displayed in the list view.

Custom Monitor Name: genw1		Details	
Common		server1	server2
Properties	Value		
Comment			
Monitor Path	genw.bat		
Status	Normal		
Resource Status on Each Server			
Server Name	Status		
server1	Normal		
server2	Normal		

Comment: Comment of the custom monitor resource
Monitor Path: Path to the monitor script
Status: The status of custom monitor resource
Resource Status on Each Server
Server Name: Server name of each server
Status: Status of the monitor resource on the given server

When you click **Details**, the following information is displayed in the pop-up dialog box.

Properties	Value
Name	genw1
Type	genw
Monitor Timing	Always
Target Resource	
Interval	60
Timeout	120
Do Not Retry at Timeout Occurrence	Off
Do Not Retry at Timeout Occurrence	Off
Retry Count	1
Final Action	No operation
Execute Script Before Reactivation	Off
Execute Script Before Failover	Off
Execute Script before Final Action	Off
Recovery Target	LocalServer
Recovery Target Type	Itself
Recovery Script Threshold	0
Reactivation Threshold	0
Failover Target Server	Stable Server
Failover Threshold	0
Wait Time to Start Monitoring	0
Dummy Failure Possibility	Possible
Collect Dump at Timeout Occurrence	Off
Run Migration Before Run Failover	Off
Monitor Type	Synchronous
Normal Return Value	0
Process Termination	Off

Name: Custom monitor resource name
Type: Monitor resource type

Monitor Timing:	Timing for the monitor resource to start monitoring
Target Resource:	Resource to be monitored
Interval (sec):	Interval between monitoring (in seconds)
Timeout (sec):	Timeout for monitoring (in seconds)
Do Not Retry at Timeout Occurrence:	Whether or not to retry when timeout occurs
Do Not Execute Recovery Action at Timeout Occurrence:	Whether or not to execute recovery action when timeout occurs
Retry Count:	The number of retries to be made from detection of an error in the monitor target to establish the error as error
Final Action:	Final action at detection of an error
Execute Script before Reactivation:	Whether the pre-reactivation script is executed upon the detection of an error
Execute Script before Failover:	Whether the pre-failover script is executed upon the detection of an error
Execute Script before Final Action:	Whether the pre-final-action script is executed upon the detection of an error
Recovery Target:	Target to be recovered when an error is detected
Recovery Target Type:	Type of target to be recovered when an error is detected
Recovery Script Threshold:	The number of times the recovery script is executed upon the detection of an error
Reactivation Threshold:	The number of times activation is retried when an activation error is detected
Failover Target Server	Determination method of Failover Target Server
Failover Threshold:	The number of failovers to be made at detection of an error
Wait Time to Start Monitoring (sec):	Time to wait before start monitoring (in seconds)
Dummy Failure Possibility:	Possibility of Dummy Failure
Collect Dump at Timeout Occurrence:	Whether or not dump of monitor process is collected when timeout occurs
Run Migration Before Run Failover:	Whether or not migration is run before running failover
Monitor Type	Execution method of monitor type
Normal Return Value:	The return value of the script when the script ended normally
Forcibly Terminate Process	Whether or not to forcibly terminate process when stopping

Understanding message receive monitor resources

Message receive monitor resources are passive monitors. They do not perform monitoring by themselves.

When an error message issued from a resource other than EXPRESSCLUSTER X is received from an outside source, the message receive monitor resources change their status and recover from the error.

Monitoring by message receive monitor resources

- When an error message is received from an outside source, the resource recovers the message receive monitor resource whose Category and Keyword have been reported. (The Keyword can be omitted.) If there are multiple message receive monitor resources whose monitor types and monitor targets have been reported, each monitor resource is recovered.
- Message receive monitors can receive error messages issued by the clprexec command, local server BMC, and expanded device drivers within the server management infrastructure.
- Error messages from local server BMC are available only in Express5800/A1080a or Express5800/A1040a series linkage. For details, see “Express5800/A1080a or Express5800/A1040a series linkage”, starting on page 1099.

When an error message is received from an outside source, the resource recovers the message receive monitor resource whose monitor type and target have been reported. (The monitor target can be omitted.)

If there are multiple message receive monitor resources whose monitor types and targets have been reported, each monitor resource is recovered.

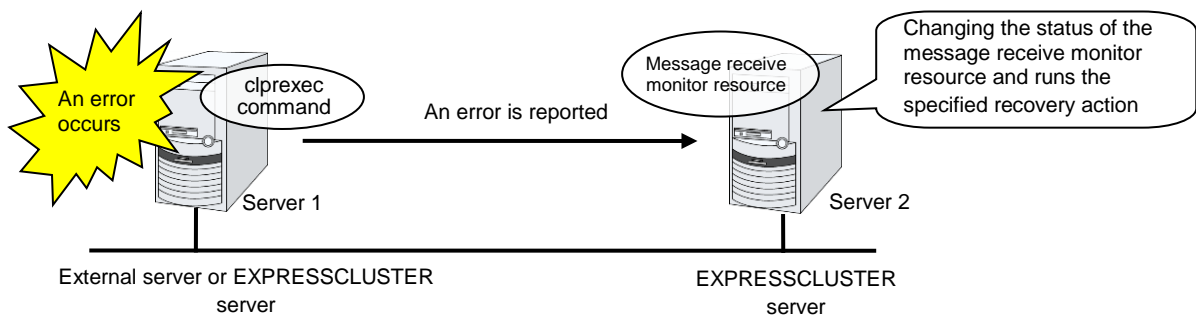

Failover to a server group at another site

- ◆ Upon the reception of notification of the occurrence of an error, failover from the active server group to another server group is allowed.
- ◆ The server groups and the following settings must be specified:
 - Recovery target group resource
 - Select **Use Server Group Settings**.
 - Message receive monitor
 - Select **Execute failover to the recovery target** for the recovery target.
 - Select **Execute Failover to outside the Server Group**.
- ◆ Upon the execution of server group failover to another site, the dynamic failover settings and inter-server group failover settings are disabled. The server fails over to the server having the highest priority in a server group other than that to which it belongs.

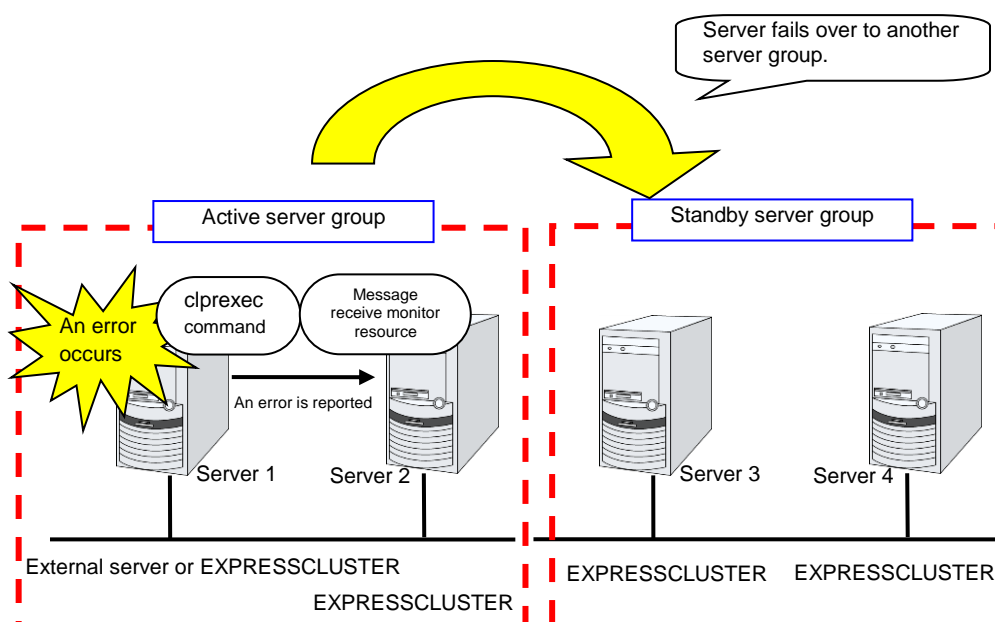

Notes on message receive monitor resources

<General notes on message receive monitor resources>

- ◆ If a message receive monitor resource is paused when an error message is received from outside, error correction is not performed.
- ◆ If an error message is received from outside, the status of the Message receive monitor resource becomes “error.” This error status is not automatically restored to “normal.” To restore the status to normal, use the clprexec command. For details about this command, see “Requesting processing to cluster servers (clprexec command)” in Chapter 3, “EXPRESSCLUSTER command reference” in this guide.
- ◆ If an error message is received when the Message receive monitor resource is already in the error status due to a previous error message, recovery from the error is not performed.
- ◆ When the recovery action is **Executing failover to the recovery target**, and if **Execute Another Server Group Failover** is selected for the recovery target, the server always fails over to a server in a server group other than the active server group. If, however, the above-mentioned settings are configured but the server group is not configured, the failover destination is determined according to the ordinary failover policy.

<Notes on using the Express5800/A1080a or Express5800/A1040a series linkage function>

- ◆ To make the BMP report an error to EXPRESSCLUSTER, the hardware and firmware on the server support this function. The ipmi service must also be started. For available models, refer to "Servers supporting Express5800/A1080a or Express5800/A1040a series linkage" in Chapter 3, "Installation requirements for EXPRESSCLUSTER" in the *Getting Started Guide*.
- ◆ To receive an error report from the BMC, communication must be enabled from the BMC network interface to the OS network interface.
- ◆ To receive an error report from the BMC, specify the IP address and port number for receiving SNMP traps for each server by using individual server settings. The port number can be omitted (default: 162). To set the port number, use the same value for all message receive monitor resources for each server.

Displaying and changing the details of the Message receive monitor resources

1. Click a monitor resource icon in the tree view on the left side of the Builder window.
2. The list of monitor resources is shown in the table view on the right side of the screen. Right-click the target monitor resource name, and then click the **Monitor(special)** tab in **Property**.
3. On the **Monitor(special)** tab, display or change the detailed settings by following the description below.

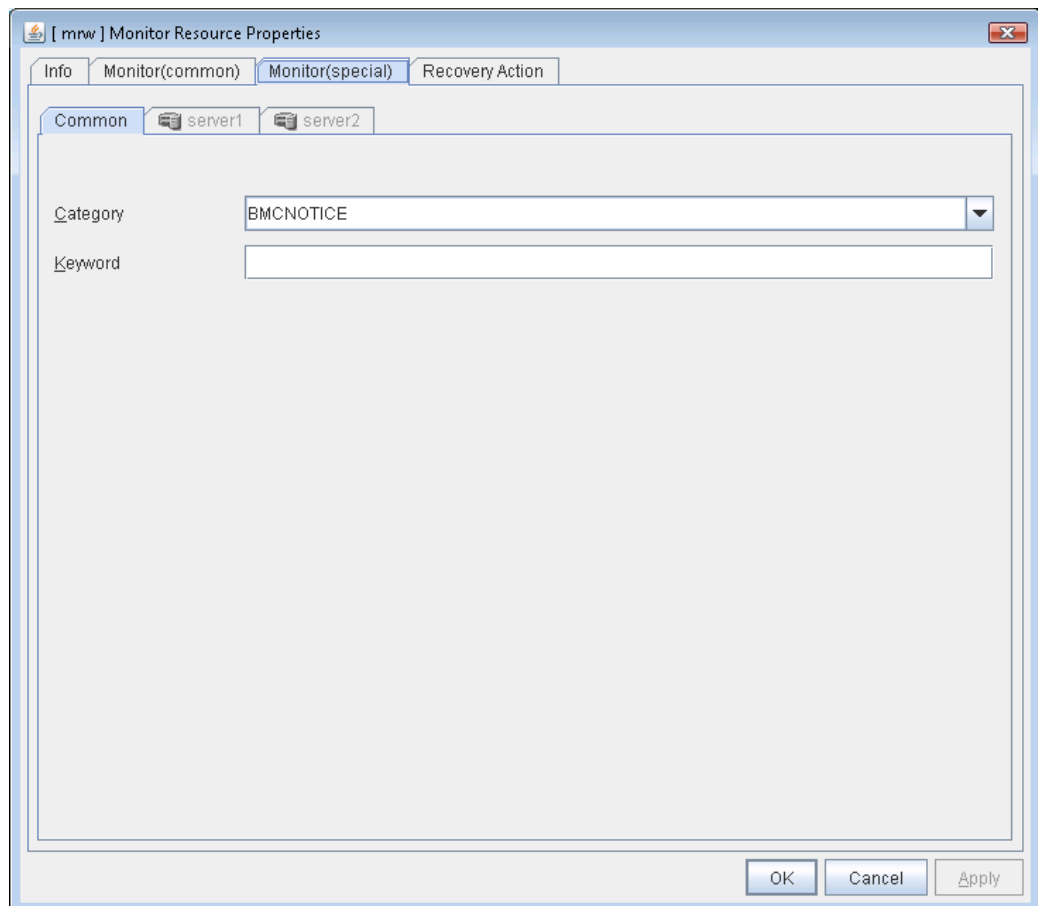

For **Category** and **Keyword**, specify a keyword passed using the -k parameter of the clprexec command. The monitor target can be omitted.

Category (within 32 bytes)

Specify the category specified with -k argument of clprexec command. To monitor an error report from the BMC (SNMP Trap), specify BMCNOTICE.

You can select an existing character string from the list box or specify a desired character string.

Keyword (within 1,023 bytes)

Specify the keyword specified with -k argument of clprexec command. When specifying BMCNOTICE for **Category**, specify the IP address and port number of the receiving SNMP Traps for each server by using individual server settings. The port number can be omitted (default: 162). To set the port number, use the same value for all the message receive monitor resources for each server. The format is as follows:

`<IP address>[:<Port number>]`

Displaying the properties of a Message receive monitor resource by using the WebManager

1. Start the WebManager (*http://Management IP address or the IP address of the cluster server: port_number* (the default value is 29003)).
2. In the tree view, click the object icon  for a message receive resource. The following information is displayed in the list view:

Message receive Monitor Name: mrw1		Details
Common server1 server2		
Properties	Value	
Comment		
keyword	Node1	
category	NIC	
Status	Normal	
Resource Status on Each Server		
Server Name	Status	
server1	Normal	
server2	Normal	

Comment: Comment on the Message receive monitor resource
 keyword: Keyword to identify the message receive monitor resource
 category: Category of the message receive monitor resource
 Status: Status of the message receive monitor resource

Resource Status on Each Server
 Server name: Server name of each server
 Status: Status of the monitor resource on each server

When you click **Details**, the following information is displayed in the pop-up dialog box.

Properties	Value
Name	mrw1
Type	mrw
Monitor Timing	Always
Target Resource	
Interval	10
Timeout	30
Do Not Retry at Timeout Occurrence	Off
Do Not Execute Recovery Action at Timeout Occurrence	Off
Retry Count	0
Final Action	No operation
Execute Script Before Reactivation	Off
Execute Script Before Failover	Off
Execute Script before Final Action	Off
Recovery Target	[All Groups]
Recovery Target Type	Group
Recovery Script Threshold	0
Reactivation Threshold	0
Failover Target Server	Stable Server
Failover Threshold	1
Wait Time to Start Monitoring	0
Dummy Failure Possibility	Impossible
Collect Dump at Timeout Occurrence	Off
Run Migration Before Run Failover	Off
Execute Failover to outside the Server Group	Off

- Name: Message receive monitor resource name
- Type: Monitor resource type
- Monitor Timing: Monitor resource monitoring start time
- Target Resource: Resource to be monitored
- Interval (sec): Interval between monitor target status checks (in seconds)
- Timeout (sec): Timeout for monitoring (in seconds)
- Do Not Retry at Timeout Occurrence: Whether or not to retry when timeout occurs
- Do Not Execute Recovery Action at Timeout Occurrence: Whether or not to execute recovery action when timeout occurs
- Retry Count: Retry count used to determine that the monitor resource has an error after detecting a monitor target error
- Final Action: Final action when an error is detected
- Execute Script before Reactivation: Whether the pre-reactivation script is executed upon the detection of an error
- Execute Script before Failover: Whether the pre-failover script is executed upon the detection of an error
- Execute Script before Final Action: Whether the pre-final-action script is executed upon the detection of an error
- Recovery Target: Recovery target when an error is detected
- Recovery Target Type: Recovery target type when an error is detected
- Recovery Script Threshold: The number of times the recovery script is executed upon the detection of an error
- Reactivation Threshold: Reactivation count when an error is detected
- Failover Target Server: Determination method of Failover Target Server
- Failover Threshold: Failover count when an error is detected
- Wait Time to Start Monitoring (sec): Wait time until monitoring starts (in seconds)
- Dummy Failure Possibility: Possibility of Dummy Failure
- Collect Dump at Timeout Occurrence: Whether or not dump of monitor process is collected when timeout occurs
- Run Migration Before Run Failover: Whether or not migration is run before running failover
- Execute Failover to outside the Server Groups: Failover to a server in a server group other than the active server group

Understanding VM monitor resources

A VM monitor resource monitors the startup status of a virtual machine managed by a VM resource.

Notes on VM monitor resources

For the supported virtual infrastructure versions, see “System requirements for the EXPRESSCLUSTER Server Operation Environment of VM resources” in Chapter 3, “Installation requirements for EXPRESSCLUSTER” in the *Getting Started Guide*.

Monitoring by VM monitor resources

VM monitor resource monitors in the following methods according to the kind of the virtual infrastructure.

Hyper-V

VM monitor resources monitor the startup status of a virtual machine by using a WMI interface.

An error is detected if the virtual machine is stopped or otherwise affected by any resource other than a VM resource.

Notes on VM monitor resources

This resource is automatically registered when VM resources are added.

Displaying the VM monitor resource properties with the WebManager

1. Start the WebManager (<http://Management IP address or the IP address of the cluster server:port number> (default value: 29003)).
2. Click a VM monitor resources object, , in the tree view. The following information is displayed in the list view.

VM Monitor Name: vmw1		Details	
Common		server1	server2
Properties	Value		
Comment			
VM Resource Name	vm1		
Status	Normal		
Resource Status on Each Server			
Server Name	Status		
server1	Offline		
server2	Offline		

VM Resource name Name of the VM resource
 Status Status of the VM monitor resource

Resource Status on Each Server
 Server name: Server name of each server
 Status: Status of the monitor resource on the given server

When you click **Details**, the following information is displayed in the pop-up dialog box.

Properties	Value
Name	vmw1
Type	vmw
Monitor Timing	Activating
Target Resource	vm 1
Interval	60
Timeout	60
Do Not Retry at Timeout Occurrence	Off
Do Not Execute Recovery Action at Timeout Occurrence	Off
Retry Count	1
Final Action	No operation
Execute Script before Reactivation	Off
Execute Script before Failover	Off
Execute Script before Final Action	Off
Recovery Target	vm 1
Recovery Target Type	Resource
Recovery Script Threshold	0
Reactivation Threshold	3
Failover Target Server	Stable Server
Failover Threshold	Number of Servers
Wait Time to Start Monitoring	0
Dummy Failure Possibility	Possible
Collect Dump at Timeout Occurrence	Off
Run Migration Before Run Failover	Off

- Name: VM monitor resource name
- Type: Monitor resource type
- Monitor Timing: Monitor resource monitoring start time
- Target Resource: Name of the VM resource to be monitored
- Interval (sec): Interval between monitor target status checks (in seconds)
- Timeout (sec): Timeout for monitoring (in seconds)
- Do Not Retry at Timeout Occurrence: Whether or not to retry when timeout occurs
- Do Not Execute Recovery Action at Timeout Occurrence: Whether or not to execute recovery action when timeout occurs
- Retry Count: Retry count used to determine that the monitor resource has an error after detecting a monitor target error
- Final Action: Final action when an error is detected
- Execute Script before Reactivation: Whether the pre-reactivation script is executed upon the detection of an error
- Execute Script before Failover: Whether the pre-failover script is executed upon the detection of an error
- Execute Script before Final Action: Whether the pre-final-action script is executed upon the detection of an error
- Recovery Target: Recovery target when an error is detected
- Recovery Target Type: Recovery target type when an error is detected
- Recovery Script Threshold: The number of times the recovery script is executed upon the detection of an error
- Reactivation Threshold: Reactivation count when an error is detected
- Failover Target Server: Determination method of Failover Target Server
- Failover Threshold: Failover count when an error is detected
- Wait Time to Start Monitoring (sec): Wait time until monitoring starts (in seconds)
- Dummy Failure Possibility: Possibility of Dummy Failure
- Collect Dump at Timeout Occurrence: Whether or not dump of monitor process is collected when timeout occurs
- Run Migration Before Run Failover: Whether or not migration is run before running failover

Understanding process name monitor resources

Process name monitor resources monitor the process of arbitrary process name.

Notes on process name monitor resources

If you set 1 for **Minimum Process Count**, and if there are two or more processes having the name specified for the monitor target, only one process is selected according to the following conditions and is subject to monitoring.

1. When the processes are in a parent-child relationship, the parent process is monitored.
2. When the processes are not in a parent-child relationship, the process having the earliest activation time is monitored.
3. When the processes are not in a parent-child relationship and their activation times are the same, the process having the lowest process ID is monitored.

If monitoring of the number of started processes is performed when there are multiple processes with the same name, specify the process count to be monitored for **Minimum Process Count**. If the number of processes with the same name falls short of the specified minimum count, an error is recognized. You can set 1 to 999 for **Minimum Process Count**. If you set 1, only one process is selected for monitoring.

Up to 1023 bytes can be specified for the monitor target process name. To specify a monitor target process with a name that exceeds 1023 bytes, use a wildcard (*).

If the name of the target process is 1024 bytes or longer, only the first 1023 bytes will be recognized as the process name. When specifying a process name by using a wild card (such as *), specify a character string that appears in the first 1023 bytes of the process name.

If the name of the target process is too long, the process name is output to the log file with the latter part omitted.

Use the following command to check the name of a process that is actually running and specify the name for the monitor target process name.

```
EXPRESSCLUSTER installation path\bin\GetProcess.vbs
```

When the above command is executed, GetProcess_Result.txt is output to the folder in which the command is executed. Open GetProcess_Result.txt and specify the CommandLine section of the process being displayed. If the output information includes double quotations (""), specify the section including the double quotations.

Example of output file

```
2012/07/26 12:03:13
Caption  CommandLine
services.exe      C:\WINDOWS\system32\services.exe
svchost.exe      C:\WINDOWS\system32\svchost -k rpcss
explorer.exe      C:\WINDOWS\Explorer.EXE
```

To monitor svchost.exe shown in the above command output information, specify C:\WINDOWS\system32\svchost -k rpcss as the monitor target process name.

The process name specified for the name of the target process specifies the target process, using the process arguments as part of the process name. To specify the name of the target process, specify the process name containing the arguments. To monitor only the process name with the arguments excluded, specify it with the wildcard (*) using right truncation or partial match excluding the arguments.

Monitoring by process name monitor resources

Those processes having the specified process name are monitored. If **Minimum Process Count** is set to 1, the process ID is determined by the process name, and the error state is determined if the process ID vanishes. Process stalls cannot be detected.

If **Minimum Process Count** is set to a value greater than 1, the number of processes that have the specified process name are monitored. The number of processes to be monitored is calculated using the process name, and if the number falls below the minimum count, an error is recognized. Process stalls cannot be detected.

Displaying and changing the process name monitor resource details

1. Click the **Monitors** icon on the tree view displayed on the left side of the Builder window.
2. The list of monitor resources is shown in the table view on the right side of the screen. Right-click the target monitor resource name, and then click the **Monitor(special)** tab in **Properties**.
3. On the **Monitor(special)** tab, display or change the detailed settings by following the description below.

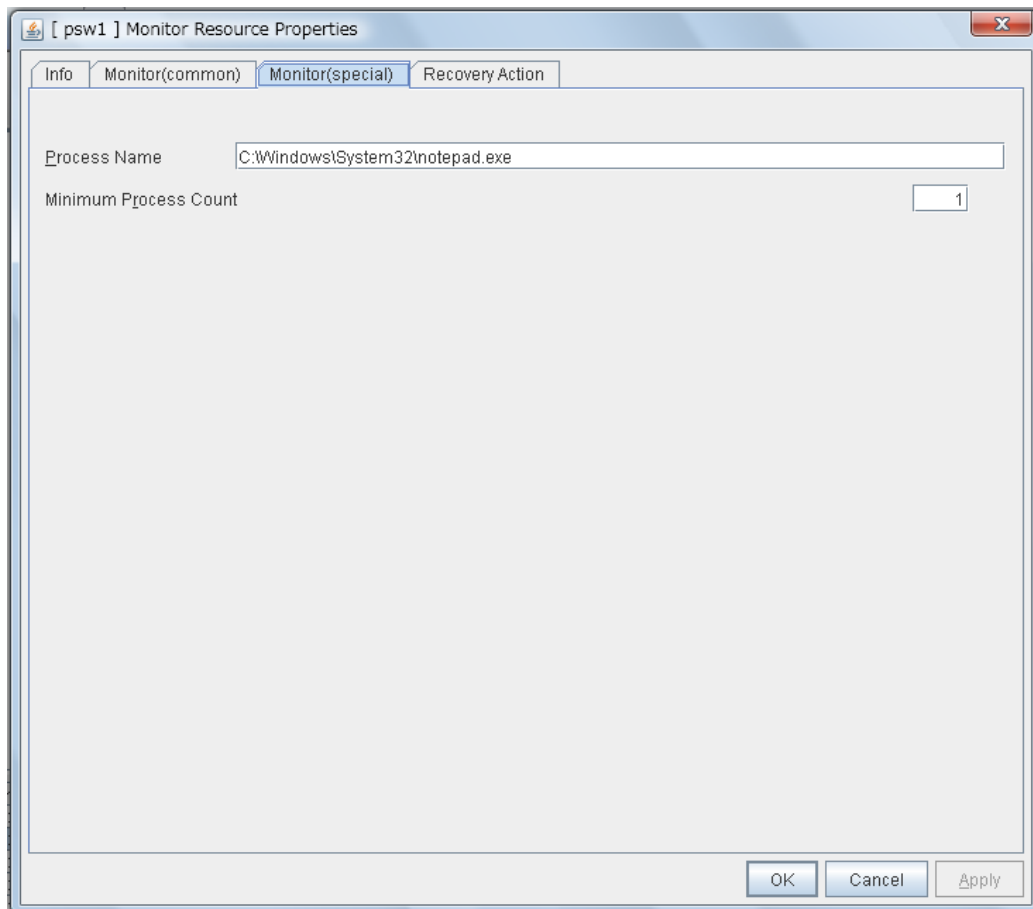

Process Name (Within 1023 bytes) **SuspendResume**

Specify the name of the process to be monitored. You must specify the process name.

Default value: None

Wild cards can be used to specify process names in the three patterns described below. Patterns other than these cannot be used.

prefix search : <character string included in process name>*

suffix search : *<character string included in process name>

partial search : *<character string included in process name>*

Minimum Process Count (1 to 999) Suspend/Resume

Set the process count to be monitored for the monitor target process. If the number of processes having the specified monitor target process name falls short of the set value, an error is recognized.

Displaying the process name monitor resource properties with WebManager

1. Start the WebManager
(http://management_IP_address_or_cluster_server_IP_address:port_number (default: 29003)).
2. Click the object corresponding to a process name monitor resource  in the tree view. The following information is displayed in the list view.

Process Name Monitor Name: psw1		Details
Common server01 server02		
Properties	Value	
Comment		
Process Name	C:\Windows\System32\notepad.exe	
Minimum Monitored Process Count	1	
Status	Normal	
Resource Status on Each Server		
Server Name	Status	
server1	Normal	
server2	Normal	

- Comment: Comment on the process name monitor resource
- Process Name: Name of the process to be monitored
- Minimum Monitored Process Count: Minimum number of processes to be monitored
- Status: Status of the process name monitor resource
- Resource Status on Each Server
- Server Name: Server name of each server
- Status: Status of the monitor resource on the given server

When you click **Details**, the following information is displayed in the pop-up dialog box.

Properties	Value
Name	psw1
Type	psw
Monitor Timing	Always
Target Resource	
Interval	5
Timeout	60
Do Not Retry at Timeout Occurrence	Off
Do Not Retry at Timeout Occurrence	Off
Retry Count	0
Final Action	No operation
Execute Script Before Reactivation	Off
Execute Script Before Failover	Off
Execute Script before Final Action	Off
Recovery Target	LocalServer
Recovery Target Type	Itself
Recovery Script Threshold	0
Reactivation Threshold	0
Failover Target Server	Stable Server
Failover Threshold	0
Wait Time to Start Monitoring	0
Dummy Failure Possibility	Possible
Collect Dump at Timeout Occurrence	Off
Run Migration Before Run Failover	Off

- Name: Name of the process monitor resource
- Type: Monitor resource type

Monitor Timing:	Monitor resource monitoring start time
Target Resource:	Resource to be monitored
Interval (sec):	Interval between monitor target status checks (in seconds)
Timeout (sec):	Timeout for monitoring (in seconds)
Do Not Retry at Timeout Occurrence:	Whether or not to retry when timeout occurs
Do Not Execute Recovery Action at Timeout Occurrence:	Whether or not to execute recovery action when timeout occurs
Retry Count:	Retry count used to determine that the monitor resource has an error after detecting a monitor target error
Final Action:	Final action when an error is detected
Execute Script before Reactivation:	Whether the pre-reactivation script is executed upon the detection of an error
Execute Script before Failover:	Whether the pre-failover script is executed upon the detection of an error
Execute Script before Final Action:	Whether the pre-final-action script is executed upon the detection of an error
Recovery Target:	Recovery target when an error is detected
Recovery Target Type:	Recovery target type when an error is detected
Recovery Script Threshold:	The number of times the recovery script is executed upon the detection of an error
Reactivation Threshold:	Reactivation count when an error is detected
Failover Target Server:	How to specify the failover target
Failover Threshold:	Failover count when an error is detected
Wait Time to Start Monitoring (sec):	Wait time until monitoring starts (in seconds)
Dummy Failure Possibility:	Possibility of Dummy Failure
Collect Dump at Timeout Occurrence:	Whether or not dump of monitor process is collected when timeout occurs
Run Migration Before Run Failover:	Whether migration before failover is enabled

Understanding DB2 monitor resources

DB2 monitor resources monitor DB2 database that runs on the server.

DB2 monitor resources

For the supported DB2 versions, see "System requirements for the EXPRESSCLUSTER Server Application supported by the monitoring options" in Chapter 3, "Installation requirements for EXPRESSCLUSTER" in the *Getting Started Guide*.

DLL interface (DB2CLI.DLL/DB2CLI64.DLL) needs to be installed on servers where monitoring is performed because DB2 CLI is used for monitoring.

For target monitoring resources, specify a service resource or a script resource that starts DB2. Monitoring starts after the target resource is activated; however, if the database cannot be started right after the target resource is activated, adjust the time by using **Wait Time to Start Monitoring**.

To monitor a DB2 database that runs in the guest OS on a virtual machine controlled by a VM resource, specify the VM resource as the monitor target and specify enough wait time for the DB2 database to become accessible after the VM resource is activated for **Wait Time to Start Monitoring**. Also, set up the DB2 client on the host OS side, where monitor resources run, and register the database on the virtual machine to the database node directory.

A monitor table is created when monitoring is started and it is deleted when monitoring is stopped due to the stop of the failover group. When monitoring is temporarily stopped or when server fails before the failover group stops due to system error, the monitor table will not be deleted. It is not an error even if an alert message saying that "a monitor table exists" is displayed next time when monitoring is started.

DB2 may produce operation logs for each monitoring. Configure DB2 settings if this needs to be adjusted.

Regarding the monitor levels described in the next subsection "Monitoring by DB2 monitor resources", when "Level 1" is selected, EXPRESSCLUSTER does not create monitor tables during monitoring. Instead, monitor tables must be created manually beforehand.

Selectable monitor level	Prior creation of a monitor table
Level 1 (monitoring by select)	Required
Level 2 (monitoring by update/select)	Optional

Create a monitor table using either of the following methods:

(In the following example, the monitor table is named DB2WATCH)

```
sql> create table DB2WATCH (num int not null primary key)
sql> insert into DB2WATCH values(0)
sql> commit
```

Monitoring by DB2 monitor resources

DB2 monitor resources perform monitoring according to the specified monitoring level.

- ◆ Level 1 (monitoring by select)

Monitoring with only reference to the monitor table. SQL statements issued to the monitor table are of (select) type.

An error is recognized if:

- (1) A database connection could not be established
- (2) An error message is sent in response to an SQL statement

- ◆ Level 2 (monitoring by update/select)

Monitoring with reference to and update of the monitoring table. One SQL statement can read/write numerical data of up to 10 digits. At monitoring start/end, the monitor table is created/deleted. SQL statements issued to the monitor table are of (create / update / select / drop) type.

An error is recognized if:

- (1) A database connection could not be established
- (2) An error message is sent in response to an SQL statement
- (3) The written data is not the same as the read data

Displaying and changing the disk DB2 monitor resource details

1. Click **Monitors** on the tree view displayed on the left side of the Builder window.
2. List of the monitor resources is displayed in the table view on the right side of the screen. Right click the target DB2 monitor resource, and click the **Monitor(special)** tab in the **Monitor Resource Property** window.
3. On the **Monitor(special)** tab, you can display and/or change the detailed settings by following the description below.

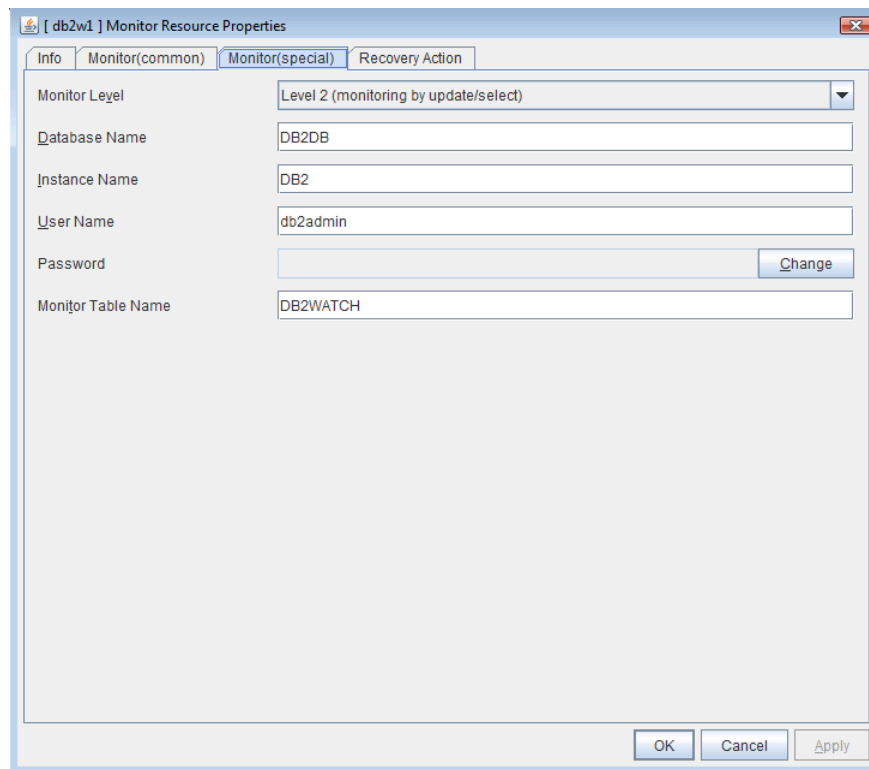

Monitor Level **Suspend/Resume**

Select one of the following levels. You cannot omit this level setting.

- ◆ Level 1 (monitoring by select)
Monitoring with only reference to the monitor table. SQL statements issued to the monitor table are of (select) type.
- ◆ Level 2 (monitoring by update/select)
Monitoring with reference to and update of the monitoring table. SQL statements issued to the monitor table are of (create / update / select / drop) type.

Default value: Level 2 (monitoring by update/select)

Database Name Within 255 bytes **Suspend/Resume**

Specify the database to be monitored. You must specify the database.

Default value: None

Instance Name Within 255 bytes **Suspend/Resume**

Specify the instance name of the database to be monitored. You must specify the instance name.

Default value: DB2

User Name Within 255 bytes **Suspend/Resume**

Specify the user name to log on to the database.

Default value: db2admin

Password Within 255 bytes **Suspend/Resume**

Specify the password to log on to the database. Click **Change** and enter the password in the dialog box.

Default value: None

Monitor Table Name Within 255 bytes **Suspend/Resume**

Specify the name of a monitor table created on the database. You must specify the name. Make sure not to specify the same name as the table used for operation because a monitor table will be created and deleted. Be sure to set the name different from the reserved word in SQL statements.

Some characters cannot be used to specify a monitor table name according to the database specifications. For details, refer to the database specifications.

Default value: DB2WATCH

Displaying the DB2 monitor resource properties with the WebManager

1. Start the WebManager (*http://Management IP address or the IP address of the cluster server: port_number* (the default value is 29003)).
2. Click a DB2 monitor resources object, , in the tree view. The following information is displayed in the list view.

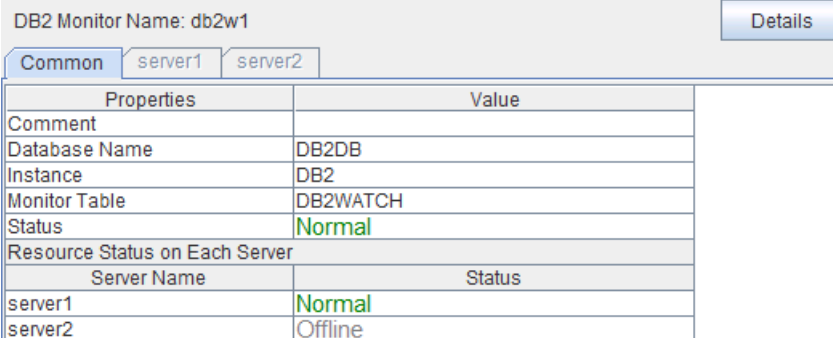

Properties	Value
Comment	
Database Name	DB2DB
Instance	DB2
Monitor Table	DB2WATCH
Status	Normal
Resource Status on Each Server	
Server Name	Status
server1	Normal
server2	Offline

Comment: Comment of the DB2 monitor resource
 Database Name: The database to be monitored
 Instance: The database instance to be monitored
 Monitor Table: A table name for monitoring
 Status: Status of the DB2 monitor resource

Resource Status on Each Server

Server Name: Server name of each server
 Status: Status of the monitor resource on the given server

When you click **Details**, the following information is displayed in the pop-up dialog box.

Properties	Value
Name	db2w1
Type	db2w
Monitor Timing	Activating
Target Resource	appli1
Interval	60
Timeout	120
Do Not Retry at Timeout Occurrence	Off
Do Not Execute Recovery Action at Timeout Occurrence	Off
Retry Count	2
Final Action	Stop the cluster service and shutdown OS
Execute Script Before Reactivation	Off
Execute Script Before Failover	Off
Execute Script before Final Action	Off
Recovery Target	LocalServer
Recovery Target Type	Itself
Recovery Script Threshold	0
Reactivation Threshold	0
Failover Target Server	Stable Server
Failover Threshold	0
Wait Time to Start Monitoring	0
Dummy Failure Possibility	Possible
Collect Dump at Timeout Occurrence	Off
Run Migration Before Run Failover	Off
Monitor Action	Level 2 (monitoring by update/select)

- Name: DB2 monitor resource name
- Type: Monitor resource type
- Monitor Timing: Timing to start monitoring
- Target Resource: Resource to be monitored
- Interval (sec): Interval between monitoring (in seconds)
- Timeout (sec): Timeout for monitoring (in seconds)
- Do Not Retry at Timeout Occurrence: Whether or not to retry when timeout occurs
- Do Not Execute Recovery Action at Timeout Occurrence: Whether or not to execute recovery action when timeout occurs
- Retry Count: The number of retries to be made from detection of an error in the monitor target to establish the error as error
- Final Action: Final action at detection of an error
- Execute Script before Reactivation: Whether the pre-reactivation script is executed upon the detection of an error
- Execute Script before Failover: Whether the pre-failover script is executed upon the detection of an error
- Execute Script before Final Action: Whether the pre-final-action script is executed upon the detection of an error
- Recovery Target: Target to be recovered when an error is detected
- Recovery Target Type: Type of target to be recovered when an error is detected
- Recovery Script Threshold: The number of times the recovery script is executed upon the detection of an error
- Reactivation Threshold: The number of reactivations to be made at detection of an error
- Failover Target Server: Determination method of Failover Target Server
- Failover Threshold: The number of failovers to be made at detection of an error
- Wait Time to Start Monitoring (sec): Time to wait before starting of monitoring (in seconds)
- Dummy Failure Possibility: Possibility of Dummy Failure
- Collect Dump at Timeout Occurrence: Whether or not dump of monitor process is collected when timeout occurs
- Run Migration Before Run Failover: Whether or not migration is run before running failover
- Monitor Action: Monitor level

Understanding FTP monitor resources

FTP monitor resources monitor FTP services that run on the server. FTP monitor resources monitor FTP protocol and they are not intended for monitoring specific applications. FTP monitor resources monitor various applications that use FTP protocol.

FTP monitor resources

For monitoring target resources, specify service resources or script resources that start FTP monitor resources. Monitoring starts after target resource is activated. However, if FTP monitor resources cannot be started immediately after target resource is activated, adjust the time using **Wait Time to Start Monitoring**.

To monitor an FTP server that runs in the guest OS on a virtual machine controlled by a VM resource, specify the VM resource as the monitor target and specify enough wait time for the FTP server to become accessible after the VM resource is activated for **Wait Time to Start Monitoring**.

FTP service may produce operation logs for each monitoring. Configure FTP settings if this needs to be adjusted.

If a change is made to a default FTP message (such as a banner or welcome message) on the FTP server, it may be handled as an error.

Monitoring by FTP monitor resources

FTP monitor resources connect to the FTP server and execute the command for acquiring the file list. As a result of monitoring, the following is considered as an error:

- (1) When connection to the FTP service fails.
- (2) When an error is notified as a response to the command.

Displaying and changing the FTP monitor resource details

1. Click **Monitors** on the tree view displayed on the left side of the Builder window.
2. List of the monitor resources is displayed in the table view on the right side of the screen. Right click the target FTP monitor resource, and click the **Monitor(special)** tab in the **Monitor Resource Property** window.
3. On the **Monitor(special)** tab, you can display and/or change the detailed settings by following the description below.

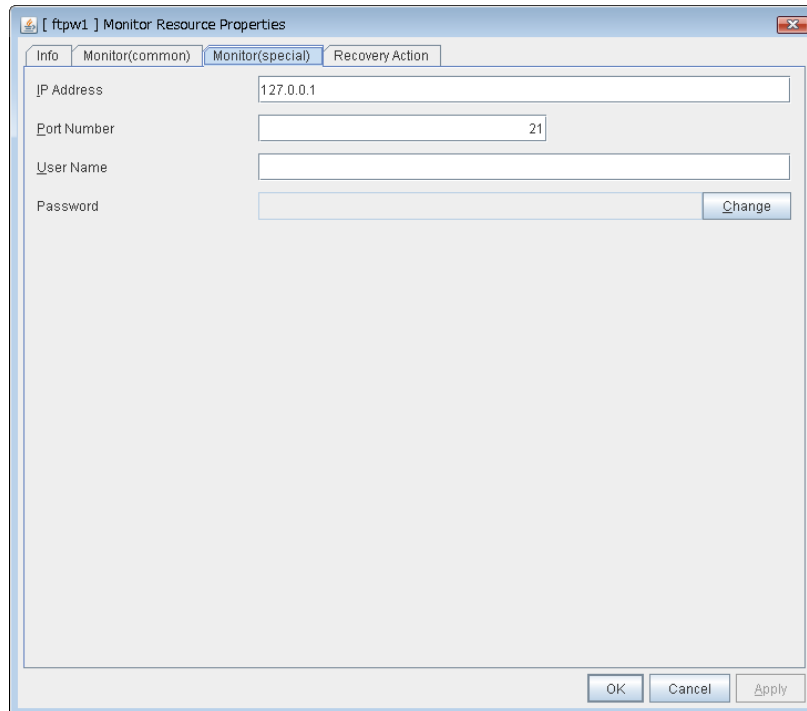

IP Address (Within 255 bytes) **SuspendResume**

Specify the IP address of the FTP server to be monitored.

Usually, specify the loopback address (127.0.0.1) to connect to the FTP server that runs on the local server. If the addresses for which connection is possible are limited by FTP server settings, specify an address for which connection is possible (such as a floating IP address). To monitor an FTP server that runs in the guest OS on a virtual machine controlled by a VM resource, specify the IP address of the virtual machine.

Default value: 127.0.0.1

Port No. (1 – 65535) **SuspendResume**

Specify the FTP port number to be monitored. You must specify a port number.

Default value: 21

User Name Within 255 bytes **SuspendResume**

Specify the user name to log on to FTP.

Default value: None

Password Within 255 bytes **Suspend/Resume**

Specify the password to log on to FTP. Click **Change** and enter the password in the dialog box.

Default value: None

Displaying the FTP monitor resource properties with the WebManager

1. Start the WebManager (*http://Management IP address or the IP address of the cluster server: port_number* (the default value is 29003)).
2. Click a FTP monitor resources object, , in the tree view. The following information is displayed in the list view.

FTP Monitor Name: ftpw1		Details
Common server1 server2		
Properties	Value	
Comment		
IP Address	127.0.0.1	
Port	21	
Status	Normal	
Resource Status on Each Server		
Server Name	Status	
server1	Normal	
server2	Offline	

Comment: Comment of the FTP monitor resource
 IP Address: IP address of the FTP server to be monitored
 Port: Port number of the FTP to be monitored
 Status: Status of the FTP monitor resource

Resource Status on Each Server
 Server Name: Server name of each server
 Status: Status of the monitor resource on the given server

When you click **Details**, the following information is displayed in the pop-up dialog box.

Properties	Value
Name	ftpw1
Type	ftpw
Monitor Timing	Activating
Target Resource	appli1
Interval	30
Timeout	60
Do Not Retry at Timeout Occurrence	Off
Do Not Execute Recovery Action at Timeout Occurrence	Off
Retry Count	3
Final Action	Stop the cluster service and shutdown OS
Execute Script Before Reactivation	Off
Execute Script Before Failover	Off
Execute Script before Final Action	Off
Recovery Target	LocalServer
Recovery Target Type	Itself
Recovery Script Threshold	0
Reactivation Threshold	0
Failover Target Server	Stable Server
Failover Threshold	0
Wait Time to Start Monitoring	0
Dummy Failure Possibility	Possible
Collect Dump at Timeout Occurrence	Off
Run Migration Before Run Failover	Off

- Name: FTP monitor resource name
- Type: Monitor resource type
- Monitor Timing: Timing to start monitoring
- Target Resource: Resource to be monitored
- Interval (sec): Interval between monitoring (in seconds)
- Timeout (sec): Timeout for monitoring (in seconds)
- Do Not Retry at Timeout Occurrence: Whether or not to retry when timeout occurs
- Do Not Execute Recovery Action at Timeout Occurrence: Whether or not to execute recovery action when timeout occurs
- Retry Count: The number of retries to be made from detection of an error in the monitor target to establish the error as error
- Final Action: Final action at detection of an error
- Execute Script before Reactivation: Whether the pre-reactivation script is executed upon the detection of an error
- Execute Script before Failover: Whether the pre-failover script is executed upon the detection of an error
- Execute Script before Final Action: Whether the pre-final-action script is executed upon the detection of an error
- Recovery Target: Target to be recovered when an error is detected
- Recovery Target Type: Type of target to be recovered when an error is detected
- Recovery Script Threshold: The number of times the recovery script is executed upon the detection of an error
- Reactivation Threshold: The number of reactivations to be made at detection of an error
- Failover Target Server: Determination method of Failover Target Server
- Failover Threshold: The number of failovers to be made at detection of an error
- Wait Time to Start Monitoring (sec): Time to wait before starting of monitoring (in seconds)
- Dummy Failure Possibility: Possibility of Dummy Failure
- Collect Dump at Timeout Occurrence: Whether or not dump of monitor process is collected when timeout occurs
- Run Migration Before Run Failover: Whether or not migration is run before running failover

Understanding HTTP monitor resources

HTTP monitor resources monitor HTTP services that run on the server. HTTP monitor resources monitor HTTP protocol but they are not intended for monitoring specific applications. HTTP monitor resources monitor various applications that implement HTTP protocol.

HTTP monitor resources

For monitoring target resources, specify service resources or script resources that start HTTP services. Monitoring starts after a target resource is activated. However, if HTTP service cannot be started immediately after the target resource is activated, adjust the time using **Wait Time to Start Monitoring**.

To monitor an HTTP server that runs in the guest OS on a virtual machine controlled by a VM resource, specify the VM resource as the monitor target and specify enough wait time for the HTTP server to become accessible after the VM resource is activated for **Wait Time to Start Monitoring**.

HTTP service may produce operation logs for each monitoring operation. Configure HTTP settings if this needs to be adjusted.

HTTP monitor resources do not support the client, BASIC, and DIGEST authentications.

Monitoring by HTTP monitor resources

HTTP monitor resources connect to the HTTP server and execute the command for acquiring HTTP header. As a result of monitoring, the following is considered as an error:

- (1) When connection to the HTTP service fails.
- (2) When an error is notified as a response to the command.

Displaying and changing the HTTP monitor resource details

1. Click **Monitors** on the tree view displayed on the left side of the Builder window.
2. List of the monitor resources is displayed in the table view on the right side of the screen. Right click the target HTTP monitor resource, and click the **Monitor(special)** tab in the **Monitor Resource Property** window.
3. On the **Monitor(special)** tab, you can display and/or change the detailed settings by following the description below.

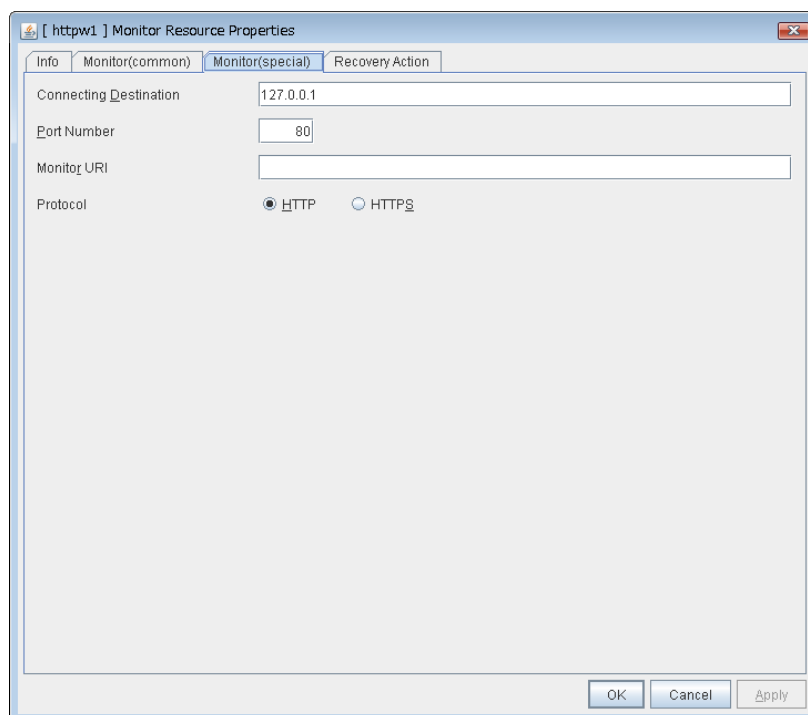

Connecting Destination (Within 255 bytes) **SuspendResume**

You must specify the IP address of the HTTP server to be monitored and this IP address. Usually, specify the loopback address (127.0.0.1) to connect to the HTTP server that runs on the local server. If the addresses for which connection is possible are limited by HTTP server settings, specify an address for which connection is possible (such as a floating IP address). To monitor an HTTP server that runs in the guest OS on a virtual machine controlled by a VM resource, specify the IP address of the virtual machine.

Default value: 127.0.0.1

Port Number (1 – 65535) **SuspendResume**

You must specify the port number of the HTTP to be monitored.

Default value: 80 (HTTP)
443 (HTTPS)

Monitor URI Within 255 bytes **SuspendResume**

Specify the URI of the HTTP to be monitored. If URI is not specified, the document root is monitored. It is not necessary to create a monitoring page. If a URI is specified, that URI is monitored. The specified URI needs to allow anonymous access.

Write the following in URI form from the DocumentRoot.
 (Example) When the URI of the web page to be monitored is as follows:
http://WebServer:80/watch/sample.htm

/watch/sample.htm

Default value: None

Protocol **SuspendResume**

Configure protocol used for communication with HTTP server. In general, HTTP is selected. If you need to connect with HTTP over SSL, select HTTPS.

Displaying the HTTP monitor resource properties with the WebManager

1. Start the WebManager (*http://Management IP address or the IP address of the cluster server: port_number* (the default value is 29003)).
2. Click an HTTP monitor resources object, , in the tree view. The following information is displayed in the list view.

HTTP Monitor Name: httpw1		Details
Common server1 server2		
Properties	Value	
Comment		
Connecting Destination	127.0.0.1	
Port	80	
URI		
Protocol	HTTP	
Status	Normal	
Resource Status on Each Server		
Server Name	Status	
server1	Normal	
server2	Offline	

Comment: Comment of the HTTP monitor resource
 Connecting Destination: IP address of the HTTP server to be monitored
 Port: Port number of the HTTP to be monitored
 URI: URI to be monitored
 Protocol: Protocol to be used for monitoring
 Status: Status of the HTTP monitor resource

Resource Status on Each Server
 Server Name: Server name of each server
 Status: Status of the monitor resource on the given server

When you click **Details**, the following information is displayed in the pop-up dialog box.

Properties	Value
Name	httpw1
Type	httpw
Monitor Timing	Activating
Target Resource	appli1
Interval	30
Timeout	60
Do Not Retry at Timeout Occurrence	Off
Do Not Execute Recovery Action at Timeout Occurrence	Off
Retry Count	3
Final Action	Stop the cluster service and shutdown OS
Execute Script Before Reactivation	Off
Execute Script Before Failover	Off
Execute Script before Final Action	Off
Recovery Target	LocalServer
Recovery Target Type	Itself
Recovery Script Threshold	0
Reactivation Threshold	0
Failover Target Server	Stable Server
Failover Threshold	0
Wait Time to Start Monitoring	0
Dummy Failure Possibility	Possible
Collect Dump at Timeout Occurrence	Off
Run Migration Before Run Failover	Off

Name:	HTTP monitor resource name
Type:	Monitor resource type
Monitor Timing:	Timing to start monitoring
Target Resource:	Resource to be monitored
Interval (sec):	Interval between monitoring (in seconds)
Timeout (sec):	Timeout for monitoring (in seconds)
Do Not Retry at Timeout Occurrence:	Whether or not to retry when timeout occurs
Do Not Execute Recovery Action at Timeout Occurrence:	Whether or not to execute recovery action when timeout occurs
Retry Count:	The number of retries to be made from detection of an error in the monitor target to establish the error as error
Final Action:	Final action at detection of an error
Recovery Script Execution Count:	The number of times the recovery script is executed upon the detection of an error
Execute Script before Reactivation:	Whether the pre-reactivation script is executed upon the detection of an error
Execute Script before Failover:	Whether the pre-failover script is executed upon the detection of an error
Execute Script before Final Action:	Whether the pre-final-action script is executed upon the detection of an error
Recovery Target:	Target to be recovered when an error is detected
Recovery Target Type:	Type of target to be recovered when an error is detected
Recovery Script Threshold:	The number of times the recovery script is executed upon the detection of an error
Reactivation Threshold:	The number of reactivations to be made at detection of an error
Failover Target Server	The server to be the failover destination at detection of an error
Failover Threshold:	The number of failovers to be made at detection of an error
Wait Time to Start Monitoring (sec):	Time to wait before starting of monitoring (in seconds)
Dummy Failure Possibility:	Possibility of Dummy Failure
Collect Dump at Timeout Occurrence:	Whether or not dump of monitor process is collected when timeout occurs
Run Migration Before Run Failover:	Whether or not migration is run before running failover

Understanding IMAP4 monitor resources

IMAP4 monitor resources monitor IMAP4 services that run on the server. IMAP4 monitor resources monitor IMAP4 protocol but they are not intended for monitoring specific applications. IMAP4 monitor resources monitor various applications that use IMAP4 protocol.

IMAP4 monitor resources

For monitoring target resources, specify service resources or script resources that start IMAP4 servers. Monitoring starts after target resource is activated. However, if IMAP4 servers cannot be started immediately after a target resource is activated, adjust the time using **Wait Time to Start Monitoring**.

To monitor an IMAP4 server that runs in the guest OS on a virtual machine controlled by a VM resource, specify the VM resource as the monitor target and specify enough wait time for the IMAP4 server to become accessible after the VM resource is activated for **Wait Time to Start Monitoring**.

IMAP4 servers may produce operation logs for each monitoring. Configure IMAP4 servers if this needs to be adjusted.

Monitoring by IMAP4 monitor resources

IMAP4 monitor resources connect to the IMAP4 server and execute the command to verify the operation. As a result of monitoring, the following is considered as an error:

- (1) When connection to the IMAP4 server fails.
- (2) When an error is notified as a response to the command.

Displaying and changing the IMAP4 monitor resource details

1. Click **Monitors** on the tree view displayed on the left side of the Builder window.
2. List of the monitor resources is displayed in the table view on the right side of the screen. Right click the target IMAP4 monitor resource, and click the **Monitor(special)** tab in the **Monitor Resource Property** window.
3. On the **Monitor(special)** tab, you can display and/or change the detailed settings by following the description below.

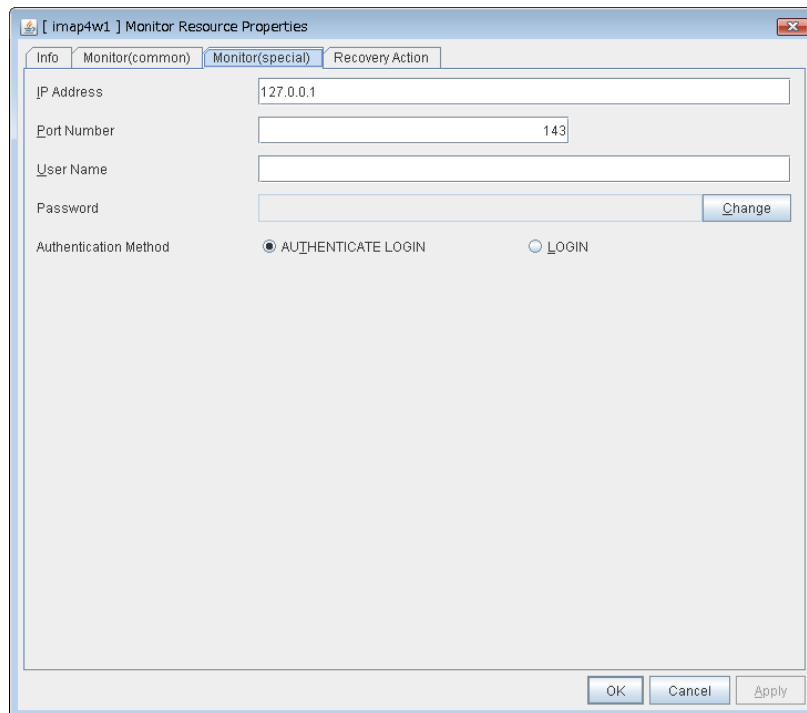

IP Address (Within 255 bytes) **SuspendResume**

Specify the IP address of the IMAP4 server to be monitored.

Usually, specify the loopback address (127.0.0.1) to connect to the IMAP4 server that runs on the local server. If the addresses for which connection is possible are limited by IMAP4 server settings, specify an address for which connection is possible (such as a floating IP address). To monitor an IMAP4 server that runs in the guest OS on a virtual machine controlled by a VM resource, specify the IP address of the virtual machine.

Default value: 127.0.0.1

Port Number (1 – 65535) **SuspendResume**

Specify the port number of the IMAP4 to be monitored. You must specify this port number.

Default value: 143

User Name Within 255 bytes **SuspendResume**

Specify the user name to log on to IMAP4.

Default value: None

Password Within 255 bytes **SuspendResume**

Specify the password to log on to IMAP4. Click **Change** and enter the password in the dialog box.

Default value: None

Authentication Method **SuspendResume**

Select the authentication method to log on to IMAP4. It must follow the settings of IMAP4 being used:

- AUTHENTICATE LOGIN (Default value)
The encryption authentication method that uses the AUTHENTICATE LOGIN command.
- LOGIN
The plaintext method that uses the LOGIN command.

Displaying the IMAP4 monitor resource properties with the WebManager

1. Start the WebManager (*http://Management IP address or the IP address of the cluster server: port_number* (the default value is 29003)).
2. Click an IMAP4 monitor resources object, , in the tree view. The following information is displayed in the list view.

IMAP4 Monitor Name: imap4w1		Details	
Common		server1	server2
Properties	Value		
Comment			
IP Address	127.0.0.1		
Port	143		
Authentication Method	AUTHENTICATE LOGIN		
Status	Normal		
Resource Status on Each Server			
Server Name	Status		
server1	Normal		
server2	Offline		

Comment: Comment of the IMAP monitor resource
 IP Address: IP address of the IMAP server to be monitored
 Port: Port number of the IMAP to be monitored
 Authentication Method: Authentication method to connect to IMAP4.
 Status: Status of the IMAP monitor resource

Resource Status on Each Server
 Server Name: Server name of each server
 Status: Status of the monitor resource on the given server

When you click **Details**, the following information is displayed in the pop-up dialog box.

Properties	Value
Name	imap4w1
Type	imap4w
Monitor Timing	Activating
Target Resource	appli1
Interval	30
Timeout	60
Do Not Retry at Timeout Occurrence	Off
Do Not Execute Recovery Action at Timeout Occurrence	Off
Retry Count	3
Final Action	Stop the cluster service and shutdown OS
Execute Script Before Reactivation	Off
Execute Script Before Failover	Off
Execute Script before Final Action	Off
Recovery Target	LocalServer
Recovery Target Type	Itself
Recovery Script Threshold	0
Reactivation Threshold	0
Failover Target Server	Stable Server
Failover Threshold	0
Wait Time to Start Monitoring	0
Dummy Failure Possibility	Possible
Collect Dump at Timeout Occurrence	Off
Run Migration Before Run Failover	Off

- Name: IMAP4 monitor resource name
- Type: Monitor resource type
- Monitor Timing: Timing to start monitoring
- Target Resource: Resource to be monitored
- Interval: Interval between monitoring (in seconds)
- Timeout: Timeout for monitoring (in seconds)
- Do Not Retry at Timeout Occurrence: Whether or not to retry when timeout occurs
- Do Not Execute Recovery Action at Timeout Occurrence: Whether or not to execute recovery action when timeout occurs
- Retry Count: The number of retries to be made from detection of an error in the monitor target to establish the error as error
- Final Action: Final action at detection of an error
- Execute Script before Reactivation: Whether the pre-reactivation script is executed upon the detection of an error
- Execute Script before Failover: Whether the pre-failover script is executed upon the detection of an error
- Execute Script before Final Action: Whether the pre-final-action script is executed upon the detection of an error
- Recovery Target: Target to be recovered when an error is detected
- Recovery Target Type: Type of target to be recovered when an error is detected
- Reactivation Threshold: The number of reactivations to be made at detection of an error
- Failover Target Server: Determination method of failover destination
- Recovery Script Threshold: The number of times the recovery script is executed upon the detection of an error
- Failover Threshold: The number of failovers to be made at detection of an error
- Wait Time to Start Monitoring: Time to wait before starting of monitoring (in seconds)
- Dummy Failure Possibility: Possibility of Dummy Failure
- Collect Dump at Timeout Occurrence: Whether or not dump of monitor process is collected when timeout occurs
- Run Migration Before Run Failover: Whether or not migration is run before running failover

Understanding ODBC monitor resources

ODBC monitor resources monitor ODBC database that runs on the server.

ODBC monitor resources

Set the data source using the ODBC data source administrator on Windows because the ODBC driver is used for monitoring. Add the data source to the system data source.

For monitoring target resources, specify service resources or script resources that start the database. Monitoring starts after target resource is activated. However, if the database cannot be started immediately after target resource is activated, adjust the time using **Wait Time to Start Monitoring**.

To monitor an ODBC database that runs in the guest OS on a virtual machine controlled by a VM resource, specify the VM resource as the monitor target and specify enough wait time for the ODBC database to become accessible after the VM resource is activated for **Wait Time to Start Monitoring**.

A monitor table is created when monitoring is started and it is deleted when monitoring is stopped due to the stop of the failover group. When monitoring is temporarily stopped or when server fails before the failover group stops due to system error, the monitor table will not be deleted. It is not an error even if an alert message saying that “a monitor table exists” is displayed next time when monitoring is started.

ODBC database may produce operation logs for each monitoring. Configure the database settings if this needs to be adjusted.

Regarding the monitor levels described in the next subsection “Monitoring by ODBC monitor resources”, when “Level 1 ” is selected, EXPRESSCLUSTER does not create monitor tables during monitoring. Instead, monitor tables must be created manually beforehand.

Selectable monitor level	Prior creation of a monitor table
Level 1 (monitoring by select)	Required
Level 2 (monitoring by update/select)	Optional

Create a monitor table using either of the following methods:

(In the following example, the monitor table is named ODBCWATCH)

```
sql> create table ODBCWATCH (num int not null primary key);
sql> insert into ODBCWATCH values(0);
sql> commit;
```

Monitoring by ODBC monitor resources

ODBC monitor resources perform monitoring according to the specified monitoring level.

- ◆ Level 1 (monitoring by select)

Monitoring with only reference to the monitor table. SQL statements issued to the monitor table are of (select) type.

An error is recognized if:

- (1) A database connection could not be established
- (2) An error message is sent in response to an SQL statement

- ◆ Level 2 (monitoring by update/select)

Monitoring with reference to and update of the monitoring table. One SQL statement can read/write numerical data of up to 10 digits. At monitoring start/end, the monitor table is created/deleted. SQL statements issued to the monitor table are of (create / update / select / drop) type.

An error is recognized if:

- (1) A database connection could not be established
- (2) An error message is sent in response to an SQL statement
- (3) The written data is not the same as the read data

Displaying and changing the ODBC monitor resource details

1. Click **Monitors** on the tree view displayed on the left side of the Builder window.
2. List of the monitor resources is displayed in the table view on the right side of the screen. Right click the target ODBC monitor resource, and click the **Monitor(special)** tab in the **Monitor Resource Property** window.
3. On the **Monitor(special)** tab, you can display and/or change the detailed settings by following the description below.

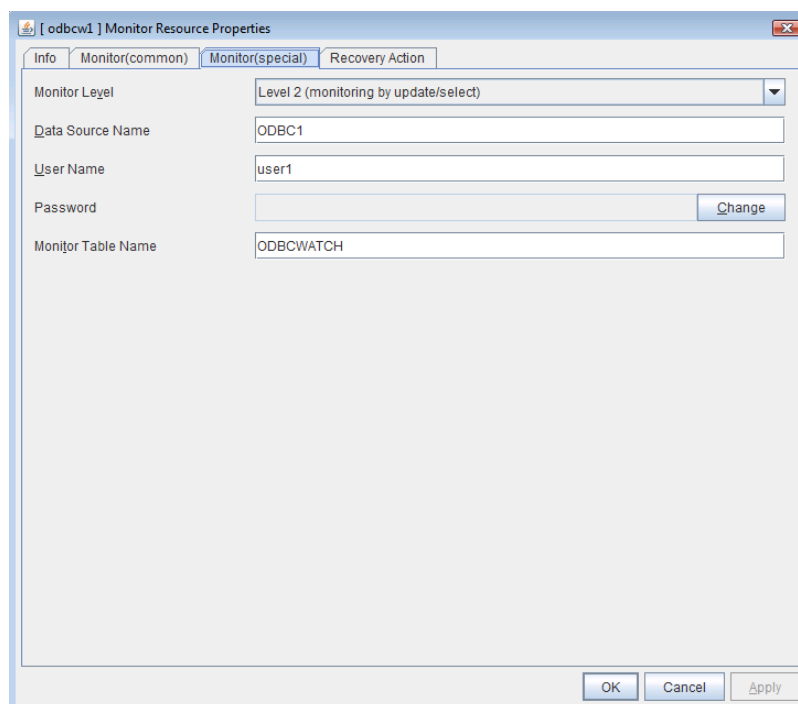

Monitor Level **SuspendResume**

Select one of the following levels. You cannot omit this level setting.

- ◆ Level 1 (monitoring by select)
 - Monitoring with only reference to the monitor table. SQL statements issued to the monitor table are of (select) type.
- ◆ Level 2 (monitoring by update/select)
 - Monitoring with reference to and update of the monitoring table. SQL statements issued to the monitor table are of (create / update / select / drop) type.

Default value: Level 2 (monitoring by update/select)

Data Source Name Within 255 bytes **SuspendResume**

Specify the data source name to be monitored. You must specify the name.

Default value: None

User Name Within 255 bytes **Suspend/Resume**

Specify the user name to log on to the database. You do not have to specify if the user name is specified in the data source settings.

Default value: None

Password Within 255 bytes **Suspend/Resume**

Specify the password to log on to the database. Click **Change** and enter the password in the dialog box.

Default value: None

Monitor Table Name Within 255 bytes **Suspend/Resume**

Specify the name of a monitor table created on the database. You must specify the name. Make sure not to specify the same name as the table used for operation because a monitor table will be created and deleted. Be sure to set the name different from the reserved word in SQL statements.

Some characters cannot be used to specify a monitor table name according to the database specifications. For details, refer to the database specifications.

Default value: ODBCWATCH

Displaying the ODBC monitor resource properties with the WebManager

1. Start the WebManager (*http://Management IP address or the IP address of the cluster server: port_number* (the default value is 29003)).
2. Click the ODBC monitor resources object, , in the tree view. The following information is displayed in the list view.

ODBC Monitor Name: odbcw1		Details
Common		server1
server2		
Properties	Value	
Comment		
Data Source Name	ODBC1	
Monitor Table	ODBCWATCH	
Status	Normal	
Resource Status on Each Server		
Server Name	Status	
server1	Normal	
server2	Offline	

Comment: Comment of the ODBC monitor resource
 Data Source Name: Data source name to be monitored
 Monitor Table: Table name for monitoring
 Status: Status of the ODBC monitor resource

Resource Status on Each Server
 Server Name: Server name of each server
 Status: Status of the monitor resource on the given server

When you click **Details**, the following information is displayed in the pop-up dialog box.

Properties	Value
Name	odbcw1
Type	odbcw
Monitor Timing	Activating
Target Resource	appli1
Interval	60
Timeout	120
Do Not Retry at Timeout Occurrence	Off
Do Not Execute Recovery Action at Timeout Occurrence	Off
Retry Count	2
Final Action	Stop the cluster service and shutdown OS
Execute Script Before Reactivation	Off
Execute Script Before Failover	Off
Execute Script before Final Action	Off
Recovery Target	LocalServer
Recovery Target Type	Itself
Recovery Script Threshold	0
Reactivation Threshold	0
Failover Target Server	Stable Server
Failover Threshold	0
Wait Time to Start Monitoring	0
Dummy Failure Possibility	Possible
Collect Dump at Timeout Occurrence	Off
Run Migration Before Run Failover	Off
Monitor Action	Level 2 (monitoring by update/select)

- Name: ODBC monitor resource name
- Type: Monitor resource type
- Monitor Timing: Timing to start monitoring
- Target Resource: Resource to be monitored
- Interval (sec): Interval between monitoring (in seconds)
- Timeout (sec): Timeout for monitoring (in seconds)
- Do Not Retry at Timeout Occurrence: Whether or not to retry when timeout occurs
- Do Not Execute Recovery Action at Timeout Occurrence: Whether or not to execute recovery action when timeout occurs
- Retry Count: The number of retries to be made from detection of an error in the monitor target to establish the error as error
- Final Action: Final action at detection of an error
- Execute Script before Reactivation: Whether the pre-reactivation script is executed upon the detection of an error
- Execute Script before Failover: Whether the pre-failover script is executed upon the detection of an error
- Execute Script before Final Action: Whether the pre-final-action script is executed upon the detection of an error
- Recovery Target: Target to be recovered when an error is detected
- Recovery Target Type: Type of target to be recovered when an error is detected
- Reactivation Threshold: The number of reactivations to be made at detection of an error
- Failover Target Server: Determination method of Failover Target Server
- Recovery Script Threshold: The number of times the recovery script is executed upon the detection of an error
- Failover Threshold: The number of failovers to be made at detection of an error
- Wait Time to Start Monitoring (sec): Time to wait before starting of monitoring (in seconds)
- Dummy Failure Possibility: Possibility of Dummy Failure
- Collect Dump at Timeout Occurrence: Whether or not dump of monitor process is collected when timeout occurs
- Run Migration Before Run Failover: Whether or not migration is run before running failover
- Monitor Action: Monitor level

Understanding Oracle monitor resources

Oracle monitor resources monitor Oracle database that runs on the server.

Oracle monitor resources

For the supported Oracle versions, see "System requirements for the EXPRESSCLUSTER Server Application supported by the monitoring options" in Chapter 3, "Installation requirements for EXPRESSCLUSTER" in the *Getting Started Guide*.

Interface DLL (OCI.DLL) needs to be installed on the server where monitoring is performed because Oracle OCI is used for monitoring.

For target a monitoring resource, specify a service resource or a script resource that can start Oracle. Monitoring starts after the target resource is activated; however, if the database cannot be started right after the target resource is activated, adjust the time by using **Wait Time to Start Monitoring**.

To monitor an Oracle database that runs in the guest OS on a virtual machine controlled by a VM resource, specify the VM resource as the monitor target and specify enough wait time for the Oracle database to become accessible after the VM resource is activated for **Wait Time to Start Monitoring**. Also, set up the Oracle client on the host OS side, where monitor resources run, and specify the connection string for connecting to the Oracle database on the virtual machine.

A monitor table is created when monitoring is started and it is deleted when monitoring is stopped due to the stop of the failover group. When monitoring is temporarily stopped or when the server fails before the failover group stops due to system error, the monitor table will not be deleted. It is not an error even if an alert message saying that "a monitor table exists" is displayed next time when monitoring is started.

The user specified for the user name parameter is sys by default, but when a monitoring-dedicated user has been configured, for each monitor level the following access permissions must be provided for that user (if the sysdba permission is not provided):

Monitor level	Necessary permissions
Level 0 (database status)	SELECT permission for V\$PROCESS / SELECT permission for V\$INSTANCE
Level 1 (monitoring by select)	SELECT permission for V\$PROCESS / SELECT permission for a monitor table
Level 2 (monitoring by update/select)	SELECT permission for V\$PROCESS / CREATE TABLE / DROP ANY TABLE / INSERT permission for a monitor table / UPDATE permission for a monitor table / SELECT permission for a monitor table

Oracle database may produce operation logs for each monitoring. Configure the Oracle settings if this needs to be adjusted.

Regarding the monitor levels described in the next subsection "Monitoring by Oracle monitor resources", when "Level 1" is selected, EXPRESSCLUSTER does not create monitor tables during monitoring. Instead, monitor tables must be created manually beforehand.

Selectable monitor level	Prior creation of a monitor table
Level 0 (database status)	Optional
Level 1 (monitoring by select)	Required
Level 2 (monitoring by update/select)	Optional

Create a monitor table using either of the following methods:

(In the following example, the monitor table is named ORAWATCH)

```
sql> create table ORAWATCH (num int primary key);
sql> insert into ORAWATCH values(0);
sql> commit;
```

*Create this in a schema for the user specified for the user name parameter.

Monitoring by Oracle monitor resources

Oracle monitor resources perform monitoring according to the specified monitor level.

◆ Level 0 (database status)

The Oracle management table (V\$INSTANCE table) is referenced to check the DB status (instance status). This level corresponds to simplified monitoring without SQL statements being executed for the monitor table.

An error is recognized if:

- (1) The Oracle management table (V\$INSTANCE table) status is in the inactive state (MOUNTED,STARTED)
- (2) The Oracle management table (V\$INSTANCE table) database_status is in the inactive state (SUSPENDED,INSTANCE RECOVERY)

◆ Level 1 (monitoring by select)

Monitoring with only reference to the monitor table. SQL statements issued to the monitor table are of (select) type.

An error is recognized if:

- (1) A database connection could not be established
- (2) An error message is sent in response to an SQL statement

◆ Level 2 (monitoring by update/select)

Monitoring with reference to and update of the monitoring table. One SQL statement can read/write numerical data of up to 10 digits. At monitoring start/end, the monitor table is created/deleted. SQL statements issued to the monitor table are of (create / update / select / drop) type.

An error is recognized if:

- (1) A database connection could not be established
- (2) An error message is sent in response to an SQL statement
- (3) The written data is not the same as the read data

Displaying and changing the Oracle monitor resource details

1. Click **Monitors** on the tree view displayed on the left side of the Builder window.
2. List of the monitor resources is displayed in the table view on the right side of the screen. Right click the target Oracle monitor resource, and click the **Monitor(special)** tab in the **Monitor Resource Property** window.
3. On the **Monitor(special)** tab, you can display and/or change the detailed settings by following the description below.

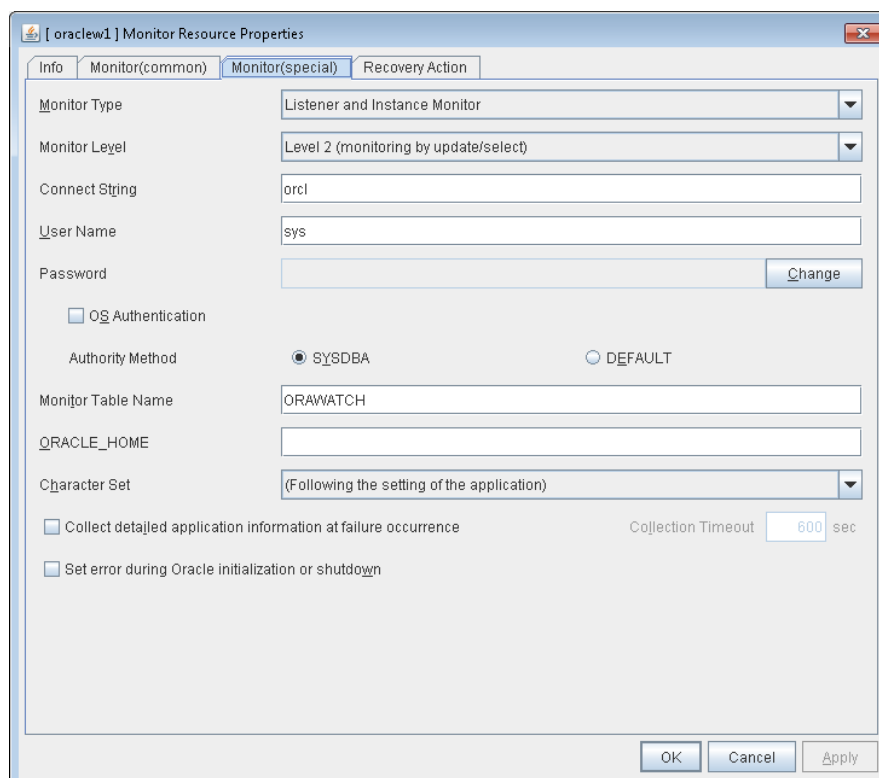

Monitor Type **Suspend/Resume**

Select the Oracle features to be monitored.

◆ Monitor Listener and Instance

According to the specified monitor level, database connection, reference, and update operations are monitored.

◆ Monitor Listener only

To check for the listener operation, use the `tnsping` Oracle command. For a monitor resource property, `ORACLE_HOME` must be set.

If `ORACLE_HOME` is not set, only connection operations for the items specified in the connect string are monitored. Use this to attempt recovery by restarting the Listener service upon a connection error.

Selecting this setting causes the monitor level setting to be ignored.

◆ Monitor Instance only

A direction (BEQ) connection to the database is established, bypassing the listener and, according to the specified monitor level, database connection, reference, and update

operations are monitored. For a monitor resource property, ORACLE_HOME must be set. This is used for direct instance monitoring and recovery action setting without routing through the listener.

A multi-tenant Oracle12c database cannot be monitored using a BEQ connection.

If ORACLE_HOME is not set, only the connection specified by the connect string is established, and any error in the connection operation is ignored. This is used to set the recovery action for a non-connection error together with an Oracle monitor resource for which **Monitor Listener only** is specified.

Default value: Monitor Listener and Instance

Monitor Level **SuspendResume**

Select one of the following levels. You cannot omit this level setting.

- ◆ Level 0 (database status)

The Oracle management table (V\$INSTANCE table) is referenced to check the DB status (instance status). This level corresponds to simplified monitoring without SQL statements being executed for the monitor table.
- ◆ Level 1 (monitoring by select)

Monitoring with only reference to the monitor table. SQL statements issued to the monitor table are of (select) type.
- ◆ Level 2 (monitoring by update/select)

Monitoring with reference to and update of the monitoring table. SQL statements issued to the monitor table are of (create / update / select / drop) type.

Default value: Level 2 (monitoring by update/select)

Connect String Within 255 bytes **SuspendResume**

Specify the connect string for the database to be monitored. You must specify the connect string.

When **Monitor Type** is set to **Monitor Instance only**, set ORACLE_SID.

Monitor Type	ORACLE_HOME	Connect Command	Monitor Level
Monitor Listener and Instance	Need not be specified	Specify the connect string	As specified
Monitor Listener only	Monitoring dependent on Oracle command if specified	Specify the connect string	Ignored
	Check for connection to the instance through the listener if not specified	Specify the connect string	Ignored
Monitor Instance only	Check for the instance by BEQ connection if specified	Specify ORACLE_SID	As specified
	Check for the instance through the listener if not specified	Specify the connect string	As specified

Default value: None for the connect string

User Name Within 255 bytes **SuspendResume**

Specify the user name to log on to the database.

Default value: sys

Password Within 255 bytes **Suspend/Resume**

Specify the password to log on to the database. Click **Change** and enter the password in the dialog box.

Default value: None

OS Authentication **Suspend/Resume**

Specify the authentication method to log on to the Oracle monitor. It must follow the Oracle monitor settings.

- When the checkbox is selected:
Use OS authentication.
- When the checkbox is not selected: (default value):
Use database authentication.

Authentication Method **Suspend/Resume**

Select the user authority to log on to the Oracle monitor. This must be set according to the authority of the specified user name.

- SYSDBA (Default value)
Connect with SYSDBA authority.
- DEFAULT
Connect with general user authority.

Monitor Table Name Within 255 bytes **Suspend/Resume**

Specify the name of a monitor table created on the database. You must specify the name. Make sure not to specify the same name as the table used for operation because a monitor table will be created and deleted. Be sure to set the name different from the reserved word in SQL statements.

Some characters cannot be used to specify a monitor table name according to the database specifications. For details, refer to the database specifications.

Default value: ORAWATCH

ORACLE_HOME Within 255 bytes **Suspend/Resume**

Specify the path name configured in ORACLE_HOME. Begin with [/]. This is used when **Monitor Type** is set to **Monitor Listener only** or **Monitor Instance only**.

Default value: None

Character Set **Suspend/Resume**

Select the character set for Oracle.

- (Following the setting of the application) (default)
The Oracle character set installed in the server is used.
- AMERICAN_AMERICA.US7ASCII
Select this when the language for Oracle is not Japanese or English.

Collect detailed application information at failure occurrence **SuspendResume**

Specify whether to collect detailed Oracle information if an Oracle database error is detected.

- When the check box is selected
Detailed Oracle information is collected.
- When the check box is cleared
Detailed Oracle information is not collected.

When using this function, the local system account needs DBA authorization because the database processing for information collection is executed by the local system account. The collected information is saved in `work\rm\resource name\errinfo.cur` folder under EXPRESSCLUSTER install folder. When collection is executed more than once, the folder names of the past collection information are renamed as `errinfo.1`, `errinfo.2`. And the folders are saved by 5 generations from the latest information.

Notes:

When the oracle service is stopped due to cluster stop or other reasons while collecting, the correct information may not be collected.

Do not perform the manual operation such as Group stop or Group move while collecting information. Monitoring process may not work normally depending on the timing of the manual operation.

Collection Timeout (1 - 9999) **SuspendResume**

Specify the timeout time for collecting detailed information in seconds.

Default value: 600

Set error during Oracle initialization or shutdown **SuspendResume**

When this function is enabled, a monitor error occurs immediately upon the detection of Oracle initialization or shutdown in progress.

Disable this function when Oracle automatically restarts in cooperation with Oracle Clusterware or the like during operation. Monitoring becomes normal even during Oracle initialization or shutdown.

However, a monitor error occurs if Oracle initialization or shutdown continues for one hour or more.

Default value: Disabled

Displaying the Oracle monitor resource properties with the WebManager

1. Start the WebManager (*http://Management IP address or the IP address of the cluster server: port_number* (the default value is 29003)).
2. Click the Oracle monitor resources object, , in the tree view. The following information is displayed in the list view.

Oracle monitor Name: oraclew1		Details	
Common		server1	server2
Properties	Value		
Comment			
Connect String	orcl		
OS authentication	Off		
Authentication Method	SYSDBA		
Monitor Table	ORAWATCH		
Status	Normal		
Resource Status on Each Server			
Server Name	Status		
server1	Normal		
server2	Offline		

Comment: Comment of the Oracle monitor resource
Connect String: Connect string for the database to be monitored
OS Authentication: Method used to connect to the database to be monitored
Authentication Method: Authentication method for the connection to the database to be monitored
Monitor Table: Table name for monitoring
Status: Status of the Oracle monitor resource

Resource Status on Each Server
Server Name: Server name of each server
Status: Status of the monitor resource on the given server

When you click **Details**, the following information is displayed in the pop-up dialog box.

Properties	Value
Name	oraclew1
Type	oraclew
Monitor Timing	Activating
Target Resource	appli1
Interval	60
Timeout	120
Do Not Retry at Timeout Occurrence	Off
Do Not Execute Recovery Action at Timeout Occurrence	Off
Retry Count	2
Final Action	Stop the cluster service and shutdown OS
Execute Script Before Reactivation	Off
Execute Script Before Failover	Off
Execute Script before Final Action	Off
Recovery Target	LocalServer
Recovery Target Type	Itself
Recovery Script Threshold	0
Reactivation Threshold	0
Failover Target Server	Stable Server
Failover Threshold	0
Wait Time to Start Monitoring	0
Dummy Failure Possibility	Possible
Collect Dump at Timeout Occurrence	Off
Run Migration Before Run Failover	Off
Monitor Action	Level 2 (monitoring by update/select)
ORACLE_HOME	
Character Set	(Following the setting of the application)
Monitor Method	Listener and Instance Monitor

Name:	Oracle monitor resource name
Type:	Monitor resource type
Monitor Timing:	Timing to start monitoring
Target Resource:	Resource to be monitored
Interval (sec):	Interval between monitoring (in seconds)
Timeout (sec):	Timeout for monitoring (in seconds)
Do Not Retry at Timeout Occurrence:	Whether or not to retry when timeout occurs
Do Not Execute Recovery Action at Timeout Occurrence:	Whether or not to execute recovery action when timeout occurs
Retry Count:	The number of retries to be made from detection of an error in the monitor target to establish the error as error
Final Action:	Final action at detection of an error
Execute Script before Reactivation:	Whether the pre-reactivation script is executed upon the detection of an error
Execute Script before Failover:	Whether the pre-failover script is executed upon the detection of an error
Execute Script before Final Action:	Whether the pre-final-action script is executed upon the detection of an error
Recovery Target:	Target to be recovered when an error is detected
Recovery Target Type:	Type of target to be recovered when an error is detected
Recovery Script Threshold:	The number of times the recovery script is executed upon the detection of an error
Reactivation Threshold:	The number of reactivations to be made at detection of an error
Failover Target Server:	The server to be the failover target at detection of an error
Failover Threshold:	The number of failovers to be made at detection of an error
Wait Time to Start Monitoring (sec):	Time to wait before starting of monitoring (in seconds)
Dummy Failure Possibility:	Possibility of Dummy Failure

Collect Dump at Timeout Occurrence:	Whether or not dump of monitor process is collected when timeout occurs
Run Migration Before Run Failover:	Whether or not migration is run before running failover
Monitor Action:	Monitor level
ORACLE_HOME:	ORACLE_HOME path name
Character Set	Character set for Oracle
Monitor Method	The Oracle features to be monitored.

Understanding OracleAS monitor resources

OracleAS monitor resource monitors Oracle application server that operates on servers.

Notes on OracleAS monitor resources

For the supported OracleAS versions, see "System requirements for the EXPRESSCLUSTER Server Application supported by the monitoring options" in Chapter 3, "Installation requirements for EXPRESSCLUSTER" in the *Getting Started Guide*.

For monitor target resources, specify service resources or script resources etc. that starts up OracleAS. After the target resource is activated, monitoring is started. When OracleAS cannot start running immediately after the target resource is activated, adjust the time in **Wait Time to Start Monitoring**.

If there is any component which does not start in OracleAS instance when monitor target resources are activated, edit opmn.xml file to change the status of the component to "disabled." For details on opmn.xml file, refer to OracleAS manual.

OracleAS may report operation log etc. for every monitoring operation, which should be controlled by the OracleAS settings.

How OracleAS monitor resources perform monitoring

OracleAS monitor resource monitors the following:

It uses the OracleAS opmnctl command to monitor the application server.

If an error is detected in the application server status acquired, it is regarded as an error:

Displaying and changing the OracleAS monitor resource details

1. Click the **Monitors** icon on the tree view displayed on the left side of the Builder window.
2. List of the monitor resources is displayed in the table view on the right side of the screen. Right-click the target OracleAS monitor resource, and click the **Monitor(special)** tab in the **Properties** window.
3. On the **Monitor(special)** tab, you can see and/or change the detailed settings by following the description below.

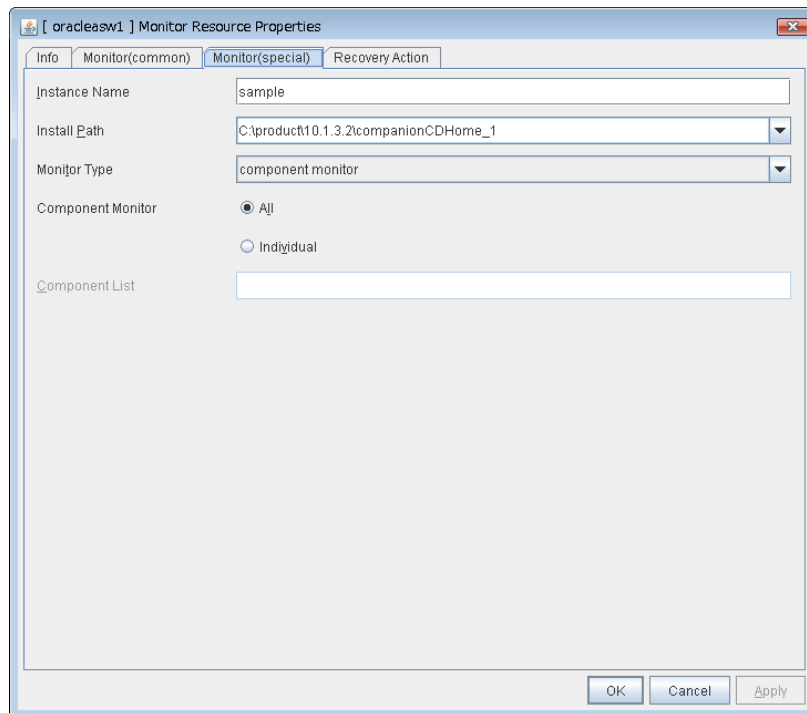

Instance Name (Within 255bytes)

Specify the instance to be monitored. You must specify the instance.

Default value: None

Installation path (Within 1023 bytes)

Specify the Oracle application install path. You must specify the path.

Default value: C:\product\10.1.3.2\companionCDHome_1

Monitor Type **SuspendResume**

Select the OracleAS features to be monitored.

- **opmn process and component monitor**
Both opmn process activation/deactivation monitoring and component status monitoring are performed.
- **opmn process monitor**
Only opmn process activation/deactivation monitoring is performed.
- **component monitor**
Only component status monitoring is performed.

Component Monitor **SuspendResume**

Select whether you specify monitor target component individually when **opmn process and component monitor** or **component monitor** is selected as Monitor Type.

- **All** (default)
All components are monitored.
- **Individual**
Only the component specified in **Component List**.

Component List (Within 1023 byte) **SuspendResume**

Enter a target component name of **component monitor**. If you want to specify two or more components, separate them by comma “,”. Make sure to set this when **Individual** is selected in **Component Monitor**.

Displaying and changing the OracleAS monitor resource properties with the WebManager

1. Start the WebManager (*http://Management IP address or the IP address of the cluster server: port_number* (the default value is 29003)).
2. When you click an object for OracleAS monitor resource  in the tree view, the following information is displayed in the list view.

OracleAS Monitor Name: oracleasw1		Details
Common server1 server2		
Properties	Value	
Comment		
Instance	Sample	
Status	Normal	
Resource Status on Each Server		
Server Name	Status	
server1	Normal	
server2	Offline	

Comment: OracleAS monitor resource comment
 Instance: Name of the instance to be monitored
 Status: Status of the OracleAS monitor resource

Resource Status on Each Server
 Server Name: Server name of each server
 Status: Status of the monitor resource on the server

When you click **Details**, the following information is displayed in the pop-up dialog box.

Properties	Value
Name	oracleasw1
Type	oracleasw
Monitor Timing	Activating
Target Resource	appli1
Interval	60
Timeout	120
Do Not Retry at Timeout Occurrence	Off
Do Not Retry at Timeout Occurrence	Off
Retry Count	1
Final Action	Stop the cluster service and shutdown OS
Execute Script Before Reactivation	Off
Execute Script Before Failover	Off
Execute Script before Final Action	Off
Recovery Target	LocalServer
Recovery Target Type	Itself
Recovery Script Threshold	0
Reactivation Threshold	0
Failover Target Server	Stable Server
Failover Threshold	0
Wait Time to Start Monitoring	0
Dummy Failure Possibility	Possible
Collect Dump at Timeout Occurrence	Off
Run Migration Before Run Failover	Off
Install Path	C:\product\10.1.3.2\companionCDHome_1
Component List	
Monitor Method	component monitor

Name: OracleAS monitor resource name
 Type: Monitor resource type

Monitor Timing:	Timing to start monitoring
Target Resource:	Resource to be monitored
Interval (sec):	Interval between monitoring
Timeout (sec):	Time to elapse from detection of an error to establish
Do Not Retry at Timeout Occurrence:	Whether or not to retry when timeout occurs
Do Not Execute Recovery Action at Timeout Occurrence:	Whether or not to execute recovery action when timeout occurs
Retry Count:	The number of retries to be made from detection of an error in the monitor target to establish the error as an error
Final Action:	Final action at detection of an error
Execute Script before Reactivation:	Whether the pre-reactivation script is executed upon the detection of an error
Execute Script before Failover:	Whether the pre-failover script is executed upon the detection of an error
Execute Script before Final Action:	Whether the pre-final-action script is executed upon the detection of an error
Recovery Target:	Target to be recovered when an error is detected
Recovery Target Type:	Type of target to be recovered when an error is detected
Recovery Script Threshold:	The number of times the recovery script is executed upon the detection of an error
Reactivation Threshold:	The number of reactivations to be made at detection of an error
Failover Target Server:	The server to be the failover target at detection of an error
Failover Threshold:	The number of failovers to be made at detection of an error
Wait Time to Start Monitoring (sec):	Time to wait before starting monitoring (in seconds)
Dummy Failure Possibility:	Possibility of Dummy Failure
Collect Dump at Timeout Occurrence:	Whether or not dump of monitor process is collected when timeout occurs
Run Migration Before Run Failover:	Whether or not migration is run before running failover
Installation path:	Install path of OracleAS
Component List:	A target component name of component monitor.
Monitor Method:	The OracleAS features to be monitored.

Understanding OfficeScan CL monitor resources

OfficeScan CL monitor resource is a monitor resource that monitors OfficeScan Client operating on servers.

Notes on OfficeScan CL monitor resources

For the supported virus buster versions, see "System requirements for the EXPRESSCLUSTER Server Application supported by the monitoring options" in Chapter 3, "Installation requirements for EXPRESSCLUSTER" in the *Getting Started Guide*.

If OfficeScan CL monitor detects issues, this monitor restarts OfficeScan NT Listener service as described below. Then, OfficeScan CL monitor may detect timeout error if it takes long time to restart the service. Please set sufficient timeout (default: 120 sec) for this monitor resource.

How OfficeScan CL monitor resource performs monitoring

OfficeScan CL monitor resource monitors the following issues.

- Monitors whether or not OfficeScan NT Listener service is active.
- Monitors the connection status between OfficeScan Client and Server.

If OfficeScan CL monitor detects errors about above issues, this monitor restarts OfficeScan NT Listener service to solve them. If it failed to solve errors, error message will be appeared on WebManager.

In addition, this monitor restarts OfficeScan NT Listener service to refresh the firewall of OfficeScan Client when floating IP and virtual IP resource are activated. Then, it will be possible to access the server via floating IP and virtual IP address.

Displaying and changing OfficeScan CL monitor resource details

There is no detail configuration in OfficeScan CL monitor resource.

Displaying OfficeScan CL monitor resource properties with the WebManager

1. Start the WebManager (*http://Management IP address or the IP address of the cluster server: port_number* (the default value is 29003)).
2. In the tree view, click OfficeScan CL monitor resource object . The following contents are displayed in the list view.

OfficeScan Client Monitor Name: oscw1		Details
Common server1 server2		
Properties	Value	
Comment		
Status	Normal	
Resource Status on Each Server		
Server Name	Status	
server1	Normal	
server2	Normal	

Comment: OfficeScan CL monitor resource comment
 Status: OfficeScan CL monitor resource status

Resource Status on Each Server

Server name: Server name of each server
 Status: Status of monitor resource on each server

When you click **Details**, the following information is displayed in the pop-up dialog box.

Properties	Value
Name	oscw1
Type	oscw
Monitor Timing	Always
Target Resource	
Interval	60
Timeout	120
Do Not Retry at Timeout Occurrence	Off
Do Not Retry at Timeout Occurrence	Off
Retry Count	1
Final Action	No operation
Execute Script Before Reactivation	Off
Execute Script Before Failover	Off
Execute Script before Final Action	Off
Recovery Target	LocalServer
Recovery Target Type	Itself
Recovery Script Threshold	0
Reactivation Threshold	0
Failover Target Server	Stable Server
Failover Threshold	0
Wait Time to Start Monitoring	0
Dummy Failure Possibility	Possible
Collect Dump at Timeout Occurrence	Off
Run Migration Before Run Failover	Off

Name: OfficeScan CL monitor resource name
 Type: Monitor resource type
 Monitor Timing: Timing to start monitor resource
 Target Resource: Resource to be monitored
 Interval (sec): Interval between monitoring (Seconds)
 Timeout (sec): Timeout for monitoring (in seconds)
 Do Not Retry at Timeout Occurrence: Whether or not to retry when timeout occurs

Do Not Execute Recovery Action at Timeout Occurrence:	Whether or not to execute recovery action when timeout occurs
Retry Count:	The number of retry to judge the target monitor resource as an error after detecting the error.
Final Action:	Final action at error detection
Execute Script before Reactivation:	Whether the pre-reactivation script is executed upon the detection of an error
Execute Script before Failover:	Whether the pre-failover script is executed upon the detection of an error
Execute Script before Final Action:	Whether the pre-final-action script is executed upon the detection of an error
Recovery Target:	Name of target to be recovered when an error is detected
Recovery Target Type:	Type of target to be recovered when an error is detected
Recovery Script Threshold:	The number of times the recovery script is executed upon the detection of an error
Reactivation Threshold:	The number of reactivation to be made at error detection
Failover Target Server:	Determination method of Failover Destination Server
Failover Threshold:	The number of failover to be made at error detection
Wait Time to Start Monitoring (sec):	Time to wait before starting of monitoring (Seconds)
Dummy Failure Possibility:	Possibility of Dummy Failure
Collect Dump at Timeout Occurrence:	Whether or not dump of monitor process is collected when timeout occurs
Run Migration Before Run Failover:	Whether or not migration is run before running failover

Understanding OfficeScan SV monitor resources

OfficeScan SV monitor resource is a monitor resource that monitors OfficeScan Server operating on servers.

Notes on OfficeScan SV monitor resources

For the supported virus buster versions, see "System requirements for the EXPRESSCLUSTER Server Application supported by the monitoring options" in Chapter 3, "Installation requirements for EXPRESSCLUSTER" in the *Getting Started Guide*.

How OfficeScan SV monitor resource perform monitoring

OfficeScan SV monitor resource monitors following issues.

- Stall monitoring of virus checking pattern distribution function.

Displaying and changing OfficeScan SV monitor resource details

There is no detail configuration in OfficeScan SV monitor resource.

Displaying OfficeScan SV monitor resource properties with the WebManager

1. Start the WebManager (*http://Management IP address or the IP address of the cluster server: port_number* (the default value is 29003)).
2. In the tree view, click OfficeScan SV monitor resource object . The following contents is displayed in the list view.

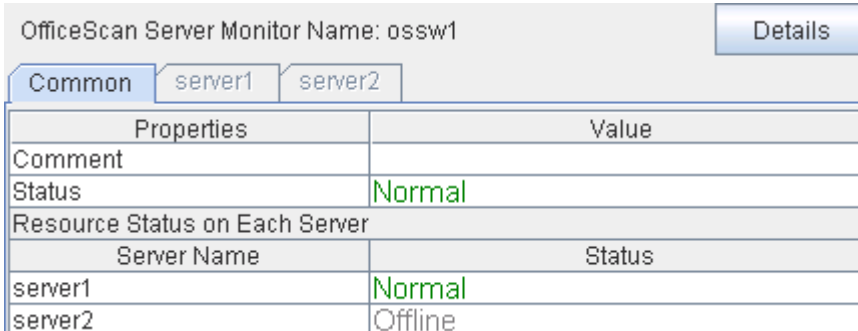

OfficeScan Server Monitor Name: ossww1		Details	
Common		server1	server2
Properties	Value		
Comment			
Status	Normal		
Resource Status on Each Server			
Server Name	Status		
server1	Normal		
server2	Offline		

Comment OfficeScan SV monitor resource comment
 Status OfficeScan SV monitor resource status

Resource Status on Each Server
 Server name Server name of each server
 Status: Status of monitor resource on each server

When you click **Details**, the following information is displayed in the pop-up dialog box.

Properties	Value
Name	ossww1
Type	ossww
Monitor Timing	Activating
Target Resource	appli1
Interval	30
Timeout	60
Do Not Retry at Timeout Occurrence	Off
Do Not Execute Recovery Action at Timeout Occurrence	Off
Retry Count	3
Final Action	Stop the cluster service and shutdown OS
Execute Script Before Reactivation	Off
Execute Script Before Failover	Off
Execute Script before Final Action	Off
Recovery Target	LocalServer
Recovery Target Type	Itself
Recovery Script Threshold	0
Reactivation Threshold	0
Failover Target Server	Stable Server
Failover Threshold	0
Wait Time to Start Monitoring	0
Dummy Failure Possibility	Possible
Collect Dump at Timeout Occurrence	Off
Run Migration Before Run Failover	Off

- Name: OfficeScan SV monitor resource name
- Type: Monitor resource type
- Monitor Timing: Timing to start monitoring
- Target Resource: Resource to be monitored
- Interval (sec): Interval between monitoring (Seconds)
- Timeout (sec): Timeout for monitoring (in seconds)
- Do Not Retry at Timeout Occurrence: Whether or not to retry when timeout occurs
- Do Not Execute Recovery Action at Timeout Occurrence: Whether or not to execute recovery action when timeout occurs
- Retry Count: The number of retry to judge the target monitor resource as an error after detecting the error.
- Final Action: Final action at detection of an error
- Execute Script before Reactivation: Whether the pre-reactivation script is executed upon the detection of an error
- Execute Script before Failover: Whether the pre-failover script is executed upon the detection of an error
- Execute Script before Final Action: Whether the pre-final-action script is executed upon the detection of an error
- Recovery Target: Target to be recovered when an error is detected
- Recovery Target Type: Type of target to be recovered when an error is detected
- Recovery Script Threshold: The number of times the recovery script is executed upon the detection of an error
- Reactivation Threshold: The number of reactivation to be made at detection of an error
- Failover Target Server: Determination method of Failover Destination Server
- Failover Threshold: The number of failover to be made at detection of an error
- Wait Time to Start Monitoring (sec): Time to wait before starting of monitoring (in seconds)
- Dummy Failure Possibility: Possibility of Dummy Failure
- Collect Dump at Timeout Occurrence: Whether or not dump of monitor process is collected when timeout occurs
- Run Migration Before Run Failover: Whether or not migration is run before running failover

Understanding POP3 monitor resources

POP3 monitor resources monitor POP3 services that run on the server. POP3 monitor resources monitor POP3 protocol but they are not intended for monitoring specific applications. POP3 monitor resources monitor various applications that use POP3 protocol.

POP3 monitor resources

For monitoring target resources, specify service resources or script resources that start POP3 services. Monitoring starts after target resource is activated. However, if POP3 services cannot be started immediately after target resource is activated, adjust the time using **Wait Time to Start Monitoring**.

To monitor a POP3 server that runs in the guest OS on a virtual machine controlled by a VM resource, specify the VM resource as the monitor target and specify enough wait time for the POP3 server to become accessible after the VM resource is activated for **Wait Time to Start Monitoring**.

POP3 services may produce operation logs for each monitoring. Configure the POP3 settings if this needs to be adjusted.

Monitoring by POP3 monitor resources

POP3 monitor resources connect to the POP3 server and execute the command to verify the operation. As a result of monitoring, the following is considered as an error:

- (1) When connection to the POP3 server fails.
- (2) When an error is notified as a response to the command.

Displaying and changing the POP3 monitor resource details

1. Click **Monitors** on the tree view displayed on the left side of the Builder window.
2. List of the monitor resources is displayed in the table view on the right side of the screen. Right click the target POP3 monitor resource, and click the **Monitor(special)** tab in the **Monitor Resource Property** window.
3. On the **Monitor(special)** tab, you can display and/or change the detailed settings by following the description below.

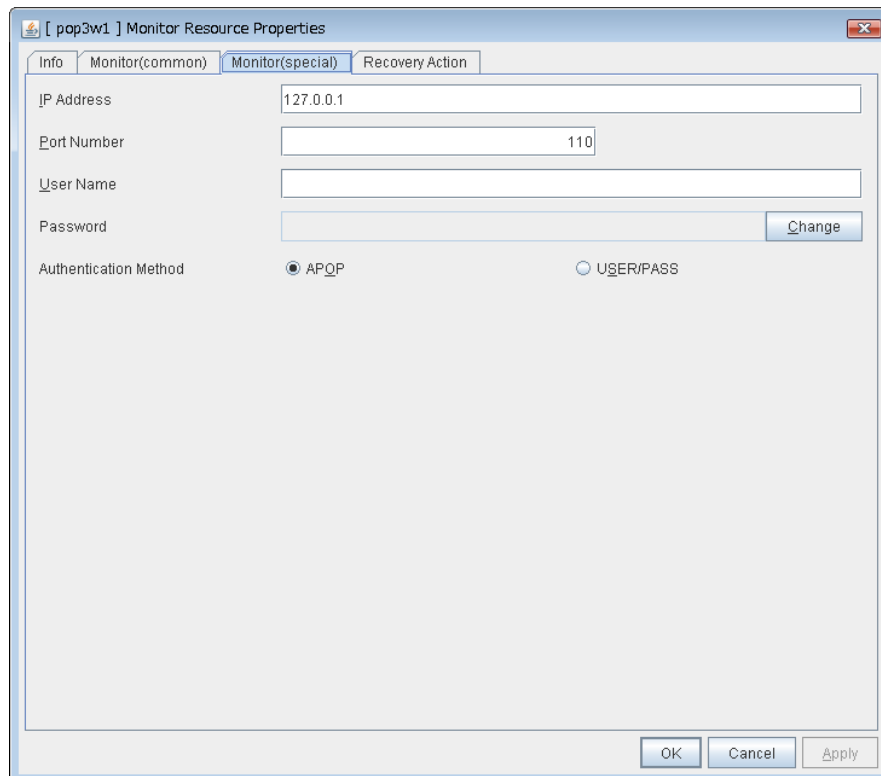

IP Address (Within 255 bytes) **SuspendResume**

Specify the IP address of the POP3 server to be monitored.

Usually, specify the loopback address (127.0.0.1) to connect to the POP3 server that runs on the local server. If the addresses for which connection is possible are limited by POP3 server settings, specify an address for which connection is possible (such as a floating IP address). To monitor a POP3 server that runs in the guest OS on a virtual machine controlled by a VM resource, specify the IP address of the virtual machine.

Default value: 127.0.0.1

Port Number (1 – 65535) **SuspendResume**

Specify the POP3 port number to be monitored. You must specify this port number.

Default value: 110

User Name Within 255 bytes **SuspendResume**

Specify the user name to log on to POP3.

Default value: None

Password Within 255 bytes **SuspendResume**

Specify the password to log on to POP3. Click **Change** and enter the password in the dialog box.

Default value: None

Authentication Method **SuspendResume**

Select the authentication method to log on to POP3. It must follow the settings of POP3 being used:

- APOP (Default value)
The encryption authentication method that uses the APOP command.
- USER/PASS
The plaintext method that uses the USER/PASS command.

Displaying the POP3 monitor resource properties with the WebManager

1. Start the WebManager (*http://Management IP address or the IP address of the cluster server: port_number* (the default value is 29003)).
2. Click the POP3 monitor resources object, , in the tree view. The following information is displayed in the list view.

POP3 Monitor Name: pop3w1		Details
Common server1 server2		
Properties	Value	
Comment		
IP Address	127.0.0.1	
Port	110	
Authentication Method	APOP	
Status	Normal	
Resource Status on Each Server		
Server Name	Status	
server1	Normal	
server2	Offline	

Comment: Comment of the POP3 monitor resource
 IP Address: IP address of the POP3 server to be monitored
 Port: Port number of the POP3 to be monitored
 Authentication Method: Authentication method to connect to POP3
 Status: Status of the POP3 monitor resource

Resource Status on Each Server
 Server Name: Server name of each server
 Status: Status of the monitor resource on the given server

When you click **Details**, the following information is displayed in the pop-up dialog box.

Properties	Value
Name	pop3w1
Type	pop3w
Monitor Timing	Activating
Target Resource	appli1
Interval	30
Timeout	60
Do Not Retry at Timeout Occurrence	Off
Do Not Execute Recovery Action at Timeout Occurrence	Off
Retry Count	3
Final Action	Stop the cluster service and shutdown OS
Execute Script Before Reactivation	Off
Execute Script Before Failover	Off
Execute Script before Final Action	Off
Recovery Target	LocalServer
Recovery Target Type	Itself
Recovery Script Threshold	0
Reactivation Threshold	0
Failover Target Server	Stable Server
Failover Threshold	0
Wait Time to Start Monitoring	0
Dummy Failure Possibility	Possible
Collect Dump at Timeout Occurrence	Off
Run Migration Before Run Failover	Off

Name:	POP3 monitor resource name
Type:	Monitor resource type
Monitor Timing:	Timing to start monitoring
Target Resource:	Resource to be monitored
Interval (sec):	Interval between monitoring (in seconds)
Timeout (sec):	Timeout for monitoring (in seconds)
Do Not Retry at Timeout Occurrence:	Whether or not to retry when timeout occurs
Do Not Execute Recovery Action at Timeout Occurrence:	Whether or not to execute recovery action when timeout occurs
Retry Count:	The number of retries to be made from detection of an error in the monitor target to establish the error as error
Final Action:	Final action at detection of an error
Execute Script before Reactivation:	Whether the pre-reactivation script is executed upon the detection of an error
Execute Script before Failover:	Whether the pre-failover script is executed upon the detection of an error
Execute Script before Final Action:	Whether the pre-final-action script is executed upon the detection of an error
Recovery Target:	Target to be recovered when an error is detected
Recovery Target Type:	Type of target to be recovered when an error is detected
Recovery Script Threshold:	The number of times the recovery script is executed upon the detection of an error
Reactivation Threshold:	The number of reactivations to be made at detection of an error
Failover Target Server:	Determination method of Failover Target Server
Failover Threshold:	The number of failovers to be made at detection of an error
Wait Time to Start Monitoring (sec):	Time to wait before starting of monitoring (in seconds)
Dummy Failure Possibility:	Possibility of Dummy Failure
Collect Dump at Timeout Occurrence:	Whether or not dump of monitor process is collected when timeout occurs
Run Migration Before Run Failover:	Whether or not migration is run before running failover

Understanding PostgreSQL monitor resources

PostgreSQL monitor resources monitor PostgreSQL database that runs on the server.

PostgreSQL monitor resources

For the supported PostgreSQL/PowerGres versions, see "System requirements for the EXPRESSCLUSTER Server Application supported by the monitoring options" in Chapter 3, "Installation requirements for EXPRESSCLUSTER" in the *Getting Started Guide*.

Interface DLL (LIBPQ.DLL) needs to be installed on the server where monitoring is performed because PostgreSQL/PowerGres library is used for monitoring. Specify the path of this DLL to the environmental variable when monitoring PostgreSQL.

For a target monitoring resource, specify a service resource or a script resource that can start PostgreSQL/PowerGres. Monitoring starts after the target resource is activated; however, if the database cannot be started right after the target resource is activated, adjust the time by using **Wait Time to Start Monitoring**.

To monitor a PostgreSQL database that runs in the guest OS on a virtual machine controlled by a VM resource, specify the VM resource as the monitor target and specify enough wait time for the PostgreSQL database to become accessible after the VM resource is activated for **Wait Time to Start Monitoring**.

A monitor table is created when monitoring is started and it is deleted when monitoring is stopped due to the stop of the failover group. When monitoring is temporarily stopped or when server fails before the failover group stops due to system error, the monitor table will not be deleted. It is not an error if an alert message saying that "a monitor table exists" is displayed next time when monitoring is started.

PostgreSQL/PowerGres may produce operation logs for each monitoring. Configure the PostgreSQL/PowerGres settings if this needs to be adjusted.

Because PostgreSQL is open-source software (OSS), its operation is checked but not guaranteed. Make sure to use PostgreSQL after evaluating it by yourself.

If PostgreSQL monitoring is performed, an error indicating that no library can be found may be output depending on the OS and PostgreSQL versions. In this case, add PostgreSQL bin to the PATH of the system environment variable. After that, restart the cluster.

When adding PATH to the environment variable (The following is an example of PATH of PostgreSQL9.1 bin.)

```
C:\Program Files\PostgreSQL\9.1\bin
```

When this monitor resource is used, messages like those shown below are output to a log on the PostgreSQL side. These messages are output by the monitor processing and do not indicate any problems.

```
YYYY-MM-DD hh:mm:ss JST moodle moodle LOG: statement: DROP TABLE
psqlwatch
YYYY-MM-DD hh:mm:ss JST moodle moodle ERROR: table "psqlwatch" does
not exist
YYYY-MM-DD hh:mm:ss JST moodle moodle STATEMENT: DROP TABLE
psqlwatch
YYYY-MM-DD hh:mm:ss JST moodle moodle LOG: statement: CREATE TABLE
psqlwatch (num INTEGER NOT NULL PRIMARY KEY)
YYYY-MM-DD hh:mm:ss JST moodle moodle NOTICE: CREATE TABLE /
PRIMARY KEY will create implicit index "psqlwatch_pkey" for table
"psql watch"
YYYY-MM-DD hh:mm:ss JST moodle moodle LOG: statement: DROP TABLE
psqlwatch
```

Regarding the monitor levels described in the next subsection “Monitoring by PostgreSQL monitor resources”, when “Level 1” is selected, EXPRESSCLUSTER does not create monitor tables during monitoring. Instead, monitor tables must be created manually beforehand.

Selectable monitor level	Prior creation of a monitor table
Level 1 (monitoring by select)	Required
Level 2 (monitoring by update/select)	Optional

Create a monitor table using either of the following methods:

(In the following example, the monitor table is named PSQLWATCH)

```
sql> create table PSQLWATCH (num int not null primary key);
sql> insert into PSQLWATCH values(0);
sql> commit;
```

Monitoring by PostgreSQL monitor resources

PostgreSQL monitor resources perform monitoring according to the specified monitor level.

- ◆ Level 1 (monitoring by select)

Monitoring with only reference to the monitor table. SQL statements issued to the monitor table are of (select) type.

An error is recognized if:

- (1) A database connection could not be established
- (2) An error message is sent in response to an SQL statement

- ◆ Level 2 (monitoring by update/select)

Monitoring with reference to and update of the monitoring table. One SQL statement can read/write numerical data of up to 10 digits. At monitoring start/end, the monitor table is created/deleted. SQL statements issued to the monitor table are of (create / update / select / reindex / drop / vacuum) type.

An error is recognized if:

- (1) A database connection could not be established
- (2) An error message is sent in response to an SQL statement
- (3) The written data is not the same as the read data

Displaying and changing the PostgreSQL monitor resource details

1. Click **Monitors** on the tree view displayed on the left side of the Builder window.
2. List of the monitor resources is displayed in the table view on the right side of the screen. Right click the target PostgreSQL monitor resource, and click the **Monitor(special)** tab in the **Monitor Resource Property** window.
3. On the **Monitor(special)** tab, you can display and/or change the detailed settings by following the description below.

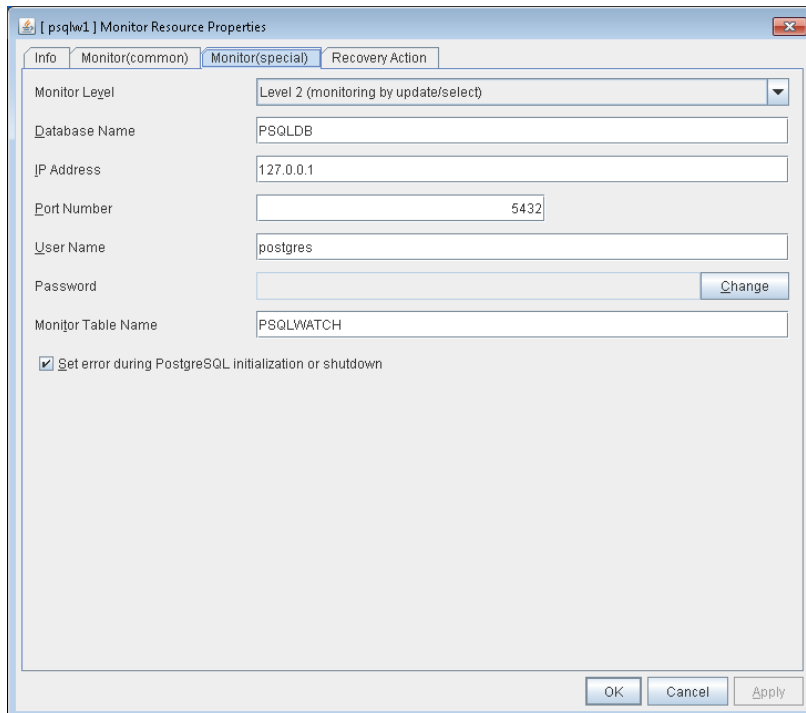

Monitor Level **SuspendResume**

Select one of the following levels. You cannot omit this level setting.

- ◆ Level 1 (monitoring by select)

Monitoring with only reference to the monitor table. SQL statements issued to the monitor table are of (select) type.
- ◆ Level 2 (monitoring by update/select)

Monitoring with reference to and update of the monitoring table. SQL statements issued to the monitor table are of (create / update / select / reindex / drop / vacuum) type.

Default value: Level 2 (monitoring by update/select)

Database Name Within 255 bytes **SuspendResume**

Specify the database name to be monitored. You must specify the name.

Default value: None

IP Address **SuspendResume**

Specify the IP address of the database server to be monitored.

Usually, specify the loopback address (127.0.0.1) to connect to the PostgreSQL server that runs on the local server. To monitor a PostgreSQL database that runs in the guest OS on a virtual machine controlled by a VM resource, specify the IP address of the virtual machine.

Default value: 127.0.0.1

Port Number **SuspendResume**

Specify the PostgreSQL port number to be monitored. You must specify this port number.

Default value: 5432

User Name Within 255 bytes **SuspendResume**

Specify the user name to log on to the database.

Default value: postgres

Password Within 255 bytes **SuspendResume**

Specify the password to log on to the database. Click **Change** and enter the password in the dialog box.

Default value: None

Monitor Table Name Within 255 bytes **SuspendResume**

You must specify the name of a monitor table created in the database. Make sure not to specify the same name as the table used for operation because a monitor table will be created and deleted. Be sure to set the name different from the reserved word in SQL statements.

Some characters cannot be used to specify a monitor table name according to the database specifications. For details, refer to the database specifications.

Default value: PSQLWATCH

Set error during PostgreSQL initialization or shutdown **SuspendResume**

When this function is enabled, a monitor error occurs immediately upon the detection of PostgreSQL start or shutdown in progress. When this function is disabled, monitoring becomes normal even during PostgreSQL initialization or shutdown. However, a monitor error occurs if PostgreSQL start or shutdown continues for one hour or more.

Default value: Disabled

Displaying the PostgreSQL monitor resource properties with the WebManager

1. Start the WebManager (*http://Management IP address or the IP address of the cluster server: port_number* (the default value is 29003)).
2. Click the PostgreSQL monitor resources object, , in the tree view. The following information is displayed in the list view.

PostgreSQL Monitor Name: psqlw1		Details
Common server1 server2		
Properties	Value	
Comment		
Database Name	PSQLDB	
IP Address	127.0.0.1	
Port	5432	
Monitor Table	PSQLWATCH	
Status	Normal	
Resource Status on Each Server		
Server Name	Status	
server1	Normal	
server2	Offline	

Comment: Comment of the PostgreSQL monitor resource
 Database name: Database name to be monitored
 IP Address: IP address of the PostgreSQL server to be monitored
 Port: Port number of the PostgreSQL to be monitored
 Monitor Table: Table name for monitoring
 Status: Status of the PostgreSQL monitor resource

Resource Status on Each Server
 Server Name: Server name of each server
 Status: Status of the monitor resource on the given server

When you click **Details**, the following information is displayed in the pop-up dialog box.

Properties	Value
Name	psqlw1
Type	psqlw
Monitor Timing	Activating
Target Resource	appli1
Interval	60
Timeout	120
Do Not Retry at Timeout Occurrence	Off
Do Not Execute Recovery Action at Timeout Occurrence	Off
Retry Count	2
Final Action	Stop the cluster service and shutdown OS
Execute Script Before Reactivation	Off
Execute Script Before Failover	Off
Execute Script before Final Action	Off
Recovery Target	LocalServer
Recovery Target Type	Itself
Recovery Script Threshold	0
Reactivation Threshold	0
Failover Target Server	Stable Server
Failover Threshold	0
Wait Time to Start Monitoring	0
Dummy Failure Possibility	Possible
Collect Dump at Timeout Occurrence	Off
Run Migration Before Run Failover	Off
Monitor Action	Level 2 (monitoring by update/select)

Name:	PostgreSQL monitor resource name
Type:	Monitor resource type
Monitor Timing:	Timing to start monitoring
Target Resource:	Resource to be monitored
Interval (sec):	Interval between monitoring (in seconds)
Timeout (sec):	Timeout for monitoring (in seconds)
Do Not Retry at Timeout Occurrence:	Whether or not to retry when timeout occurs
Do Not Execute Recovery Action at Timeout Occurrence:	Whether or not to execute recovery action when timeout occurs
Retry Count:	The number of retries to be made from detection of an error in the monitor target to establish the error as error
Final Action:	Final action at detection of an error
Recovery Script Execution Count:	The number of times the recovery script is executed upon the detection of an error
Execute Script before Reactivation:	Whether the pre-reactivation script is executed upon the detection of an error
Execute Script before Failover:	Whether the pre-failover script is executed upon the detection of an error
Execute Script before Final Action:	Whether the pre-final-action script is executed upon the detection of an error
Recovery Target:	Target to be recovered when an error is detected
Recovery Target Type:	Type of target to be recovered when an error is detected
Recovery Script Threshold:	The number of times the recovery script is executed upon the detection of an error
Reactivation Threshold:	The number of reactivations to be made at detection of an error
Failover Target Server:	Determination method of Failover Target Server
Failover Threshold:	The number of failovers to be made at detection of an error
Wait Time to Start Monitoring (sec):	Time to wait before starting of monitoring (in seconds)
Dummy Failure Possibility:	Possibility of Dummy Failure

Collect Dump at Timeout Occurrence: Whether or not dump of monitor process is collected when timeout occurs

Run Migration Before Run Failover: Whether or not migration is run before running failover

Monitor Action: Monitor level

Understanding SMTP monitor resources

SMTP monitor resources monitor SMTP services that run on the server. SMTP monitor resources monitor SMTP protocol but they are not intended for monitoring specific applications. SMTP monitor resources monitor various applications that use SMTP protocol.

SMTP monitor resources

For monitoring target resources, specify service resources or script resources that start SMTP. Monitoring starts after target resource is activated. However, if the database cannot be started immediately after target resource is activated, adjust the time using **Wait Time to Start Monitoring**.

To monitor an SMTP server that runs in the guest OS on a virtual machine controlled by a VM resource, specify the VM resource as the monitor target and specify enough wait time for the SMTP server to become accessible after the VM resource is activated for **Wait Time to Start Monitoring**.

SMTP services may produce operation logs for each monitoring. Configure the SMTP settings if

Monitoring by SMTP monitor resources

POP3 monitor resources connect to the POP3 server and execute the command to verify the operation. As a result of monitoring, the following is considered as an error:

- (1) When connection to the SMTP server fails.
- (2) When an error is notified as a response to the command.

Displaying and changing the SMTP monitor resource details

1. Click **Monitors** on the tree view displayed on the left side of the Builder window.
2. List of the monitor resources is displayed in the table view on the right side of the screen. Right click the target SMTP monitor resource, and click the **Monitor(special)** tab in the **Monitor Resource Property** window.
3. On the **Monitor(special)** tab, you can display and/or change the detailed settings by following the description below.

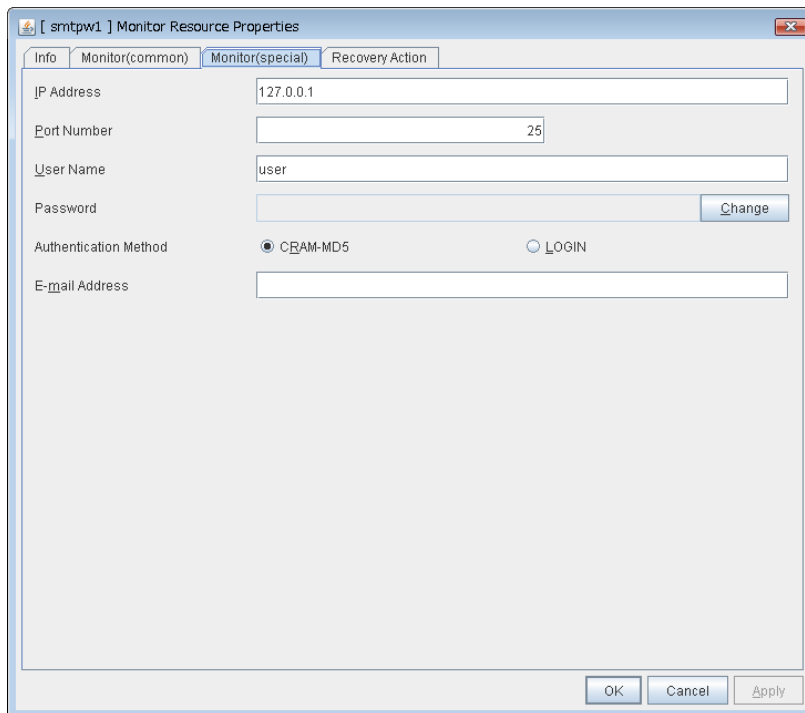

IP Address **Suspend/Resume**

You must specify the IP address of the SMTP server to be monitored.

Usually, specify the loopback address (127.0.0.1) to connect to the SMTP server that runs on the local server. To monitor an SMTP server that runs in the guest OS on a virtual machine controlled by a VM resource, specify the IP address of the virtual machine.

Default value: 127.0.0.1

Port No. **Suspend/Resume**

Specify the port number of the SMTP to be monitored. You must specify this port number.

Default value: 25

User Name Within 255 bytes **Suspend/Resume**

Specify the user name to log on to SMTP. If no user name is specified, SMTP authentication is not performed.

Default value: None

Password Within 255 bytes **Suspend/Resume**

Specify the password to log on to SMTP. Click **Change** and enter the password in the dialog box.

Default value: None

Authentication Method **Suspend/Resume**

Select the authentication method to log on to the SMTP. It must follow the settings of SMTP being used:

- **CRAM-MD5 (Default value)**
The encryption authentication method that uses the CRAM-MD5 command.
- **LOGIN**
The plaintext method that uses the LOGIN command.

E-mail Address Within 255 bytes **Suspend/Resume**

Specify the email address used for monitoring. If nothing is specified, monitoring is performed using the command to verify the operation. The command that uses a dummy e-mail address is executed internally. If an email address is specified, monitoring is performed by running SMTP command to the specified e-mail address and verifying the result of it. It is recommended to have an e-mail address dedicated to monitoring.

Default value: None

Displaying the SMTP monitor resource properties with the WebManager

1. Start the WebManager (*http://Management IP address or the IP address of the cluster server: port_number* (the default value is 29003)).
2. Click the SMTP monitor resources object, , in the tree view. The following information is displayed in the list view.

SMTP Monitor Name: smtpw1		Details	
Common		server1	server2
Properties	Value		
Comment			
IP Address	127.0.0.1		
Port	25		
Authentication Method	CRAM-MD5		
Mail Address			
Status	Normal		
Resource Status on Each Server			
Server Name	Status		
server1	Offline		
server2	Normal		

Comment: Comment of the SMTP monitor resource
IP Address: IP address of the SMTP server to be monitored
Port: Port number of the SMTP to be monitored
Authentication Method: Authentication method to connect to SMTP (If user name for SMTP authentication is not set, what is displayed here is not effective)
Mail Address: E-mail address for monitoring
Status: Status of the SMTP monitor resource

Resource Status on Each Server
Server Name: Server name of each server
Status: Status of the monitor resource on the given server

When you click **Details**, the following information is displayed in the pop-up dialog box.

Properties	Value
Name	smtpw1
Type	smtpw
Monitor Timing	Activating
Target Resource	appli1
Interval	30
Timeout	60
Do Not Retry at Timeout Occurrence	Off
Do Not Execute Recovery Action at Timeout Occurrence	Off
Retry Count	3
Final Action	Stop the cluster service and shutdown OS
Execute Script Before Reactivation	Off
Execute Script Before Failover	Off
Execute Script before Final Action	Off
Recovery Target	LocalServer
Recovery Target Type	Itself
Recovery Script Threshold	0
Reactivation Threshold	0
Failover Target Server	Stable Server
Failover Threshold	0
Wait Time to Start Monitoring	0
Dummy Failure Possibility	Possible
Collect Dump at Timeout Occurrence	Off
Run Migration Before Run Failover	Off

Name:	SMTP monitor resource
Type:	Monitor resource type
Monitor Timing:	Timing to start monitoring
Target Resource:	Resource to be monitored
Interval (sec):	Interval between monitoring (in seconds)
Timeout (sec):	Timeout for monitoring (in seconds)
Do Not Retry at Timeout Occurrence:	Whether or not to retry when timeout occurs
Do Not Execute Recovery Action at Timeout Occurrence:	Whether or not to execute recovery action when timeout occurs
Retry Count:	The number of retries to be made from detection of an error in the monitor target to establish the error as error
Final Action:	Final action at detection of an error
Execute Script before Reactivation:	Whether the pre-reactivation script is executed upon the detection of an error
Execute Script before Failover:	Whether the pre-failover script is executed upon the detection of an error
Execute Script before Final Action:	Whether the pre-final-action script is executed upon the detection of an error
Recovery Target:	Target to be recovered when an error is detected
Recovery Target Type:	Type of target to be recovered when an error is detected
Recovery Script Threshold:	The number of times the recovery script is executed upon the detection of an error
Reactivation Threshold:	The number of reactivations to be made at detection of an error
Failover Target Server:	Determination method of Failover Target Server
Failover Threshold:	The number of failovers to be made at detection of an error
Wait Time to Start Monitoring (sec):	Time to wait before starting of monitoring (in seconds)
Dummy Failure Possibility:	Possibility of Dummy Failure
Collect Dump at Timeout Occurrence:	Whether or not dump of monitor process is collected when timeout occurs
Run Migration Before Run Failover:	Whether or not migration is run before running failover

Understanding SQL Server monitor resources

SQL Server monitor resources monitor SQL Server database that runs on the server.

SQL Server monitor resources

For the supported SQL Server versions, see "System requirements for the EXPRESSCLUSTER Server Application supported by the monitoring options" in Chapter 3, "Installation requirements for EXPRESSCLUSTER" in the *Getting Started Guide*.

For target monitoring resource, specify a service resource that can start SQL Server. Monitoring starts after the target resource is activated; however, if the database cannot be started right after the target resource is activated, adjust the time by using **Wait Time to Start Monitoring**.

To monitor an SQL Server database that runs in the guest OS on a virtual machine controlled by a VM resource, specify the VM resource as the monitor target and specify enough wait time for the SQL Server database to become accessible after the VM resource is activated for **Wait Time to Start Monitoring**. Also, set up the SQL Server client on the host OS side, where monitor resources run, and specify the name of the virtual machine server as the instance name of the monitor target.

A monitor table is created when monitoring is started and it is deleted when monitoring is stopped due to the stop of the failover group. When monitoring is temporarily stopped or when server fails before the failover group stops due to system error, the monitor table will not be deleted. It is not an error if an alert message saying that "a monitor table exists" is displayed next time when monitoring is started.

SQL Server may produce operation logs for each monitoring. Configure the SQL Server settings if this needs to be adjusted.

Regarding the monitor levels described in the next subsection "Monitoring by SQL Server monitor resources", when "Level 1" is selected, EXPRESSCLUSTER does not create monitor tables during monitoring. Instead, monitor tables must be created manually beforehand.

Selectable monitor level	Prior creation of a monitor table
Level 0 (database status)	Optional
Level 1 (monitoring by select)	Required
Level 2 (monitoring by update/select)	Optional

Create a monitor table using either of the following methods:

(In the following example, the monitor table is named SQLWATCH)

```
sql> create table SQLWATCH (num int not null primary key)
```

```
sql> go
```

```
sql> insert into SQLWATCH values(0)
```

```
sql> go
```

* However, if SET IMPLICIT_TRANSACTIONS is set to ON, execute the following:

```
sql> commit
```

```
sql> go
```

Monitoring by SQL Server monitor resources

SQL Server monitor resources perform monitoring according to the specified monitor level.

- ◆ Level 0 (database status)

The SQL Server management table (sys.databases) is referenced to check the DB status. This level corresponds to simplified monitoring without SQL statements being executed for the monitor table.

An error is recognized if:

- (1) The database status is not online

- ◆ Level 1 (monitoring by select)

Monitoring with only reference to the monitor table. SQL statements issued to the monitor table are of (select) type.

An error is recognized if:

- (1) A database connection could not be established
- (2) An error message is sent in response to an SQL statement

- ◆ Level 2 (monitoring by update/select)

Monitoring with reference to and update of the monitoring table. One SQL statement can read/write numerical data of up to 10 digits. At monitoring start/end, the monitor table is created/deleted. SQL statements issued to the monitor table are of (create / update / select / drop) type.

An error is recognized if:

- (1) A database connection could not be established
- (2) An error message is sent in response to an SQL statement
- (3) The written data is not the same as the read data

Displaying and changing the SQL Server monitor resource details

1. Click **Monitors** on the tree view displayed on the left side of the Builder window.
2. List of the monitor resources is displayed in the table view on the right side of the screen. Right click the target SQL Server monitor resource, and click the **Monitor(special)** tab in the **Monitor Resource Property** window.
3. On the **Monitor(special)** tab, you can display and/or change the detailed settings by following the description below.

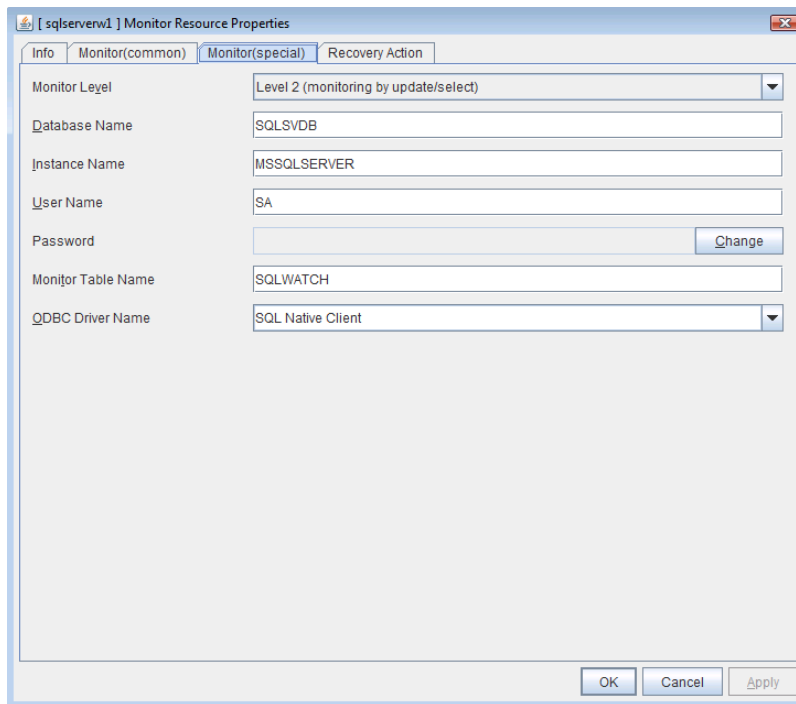

Monitor Level **SuspendResume**

Select one of the following levels. You cannot omit this level setting.

- ◆ Level 0 (database status)

The SQL Server management table (sys.databases) is referenced to check the DB status.
- ◆ Level 1 (monitoring by select)

Monitoring with only reference to the monitor table. SQL statements issued to the monitor table are of (select) type.
- ◆ Level 2 (monitoring by update/select)

Monitoring with reference to and update of the monitoring table. SQL statements issued to the monitor table are of (create / update / select / drop) type.

Default value: Level 2 (monitoring by update/select)

Database Name Within 255 bytes **SuspendResume**

Specify the database name to be monitored. You must specify the name.

Default value: None

Instance Name Within 255 bytes **Suspend/Resume**

Specify the database instance name. You must specify the instance name.

To monitor an SQL Server database that runs in the guest OS on a virtual machine controlled by a VM resource, specify the virtual machine name in the format of “server-name\instance-name.”

Default value: MSSQLSERVER

User Name Within 255 bytes **Suspend/Resume**

Specify the user name to log on to the database. If the user name is not specified, Windows authentication is used.

Default value: SA

Password Within 255 bytes **Suspend/Resume**

Specify the password to log on to the database. Click **Change** and enter the password in the dialog box.

Default value: None

Monitor Table Name Within 255 bytes **Suspend/Resume**

Specify the name of a monitor table created on the database. You must specify the name. Make sure not to specify the same name as the table used for operation because a monitor table will be created and deleted. Be sure to set the name different from the reserved word in SQL statements.

Some characters cannot be used to specify a monitor table name according to the database specifications. For details, refer to the database specifications.

Default value: SQLWATCH

ODBC Driver Name (Within 255 bytes) **Suspend/Resume**

Specify the driver name of the target database shown in the **Driver** tab when you click **Start** -> **Administrative Tools** -> **Data Sources (ODBC)**.

Select **SQL Native Client** in SQL Server 2005.

Select **SQL Server Native Client 10.0** in SQL Server 2008.

Select **SQL Server Native Client 11.0** in SQL Server 2012 or SQL Server 2014.

Select ODBC Driver 13 for SQL Server in SQL Server 2016.

Default value: SQL Native Client

Displaying the SQL Server monitor resource properties with the WebManager

1. Start the WebManager (*http://Management IP address or the IP address of the cluster server: port_number* (the default value is 29003)).
2. Click the SQL Server monitor resources object, , in the tree view. The following information is displayed in the list view.

SQL Server Monitor Name: sqlserverw1		Details
Common server1 server2		
Properties	Value	
Comment		
Database Name	SQLSVDB	
Instance	MSSQLSERVER	
Monitor Table	SQLWATCH	
Status	Normal	
Resource Status on Each Server		
Server Name	Status	
server1	Normal	
server2	Offline	

Comment: Comment of the SQL Server monitor resource
 Database name: Database name to be monitored
 Instance: Instance name of the database to be monitored
 Monitor Table: Table name for monitoring
 Status: Status of the SQL Server monitor resource

Resource Status on Each Server
 Server Name: Server name of each server
 Status: Status of the monitor resource on the given server

When you click **Details**, the following information is displayed in the pop-up dialog box.

Properties	Value
Name	sqlserverw1
Type	sqlserverw
Monitor Timing	Activating
Target Resource	appli1
Interval	60
Timeout	120
Do Not Retry at Timeout Occurrence	Off
Do Not Retry at Timeout Occurrence	Off
Retry Count	2
Final Action	Stop the cluster service and shutdown OS
Execute Script Before Reactivation	Off
Execute Script Before Failover	Off
Execute Script before Final Action	Off
Recovery Target	LocalServer
Recovery Target Type	Itself
Recovery Script Threshold	0
Reactivation Threshold	0
Failover Target Server	Stable Server
Failover Threshold	0
Wait Time to Start Monitoring	0
Dummy Failure Possibility	Possible
Collect Dump at Timeout Occurrence	Off
Run Migration Before Run Failover	Off
Monitor Action	Level 2 (monitoring by update/select)
ODBC Driver Name	SQL Native Client

Name:	SQL Server monitor resource name
Type:	Monitor resource type
Monitor Timing:	Timing to start monitoring
Target Resource:	Resource to be monitored
Interval (sec):	Interval between monitoring (in seconds)
Timeout (sec):	Timeout for monitoring (in seconds)
Do Not Retry at Timeout Occurrence:	Whether or not to retry when timeout occurs
Do Not Execute Recovery Action at Timeout Occurrence:	Whether or not to execute recovery action when timeout occurs
Retry Count:	The number of retries to be made from detection of an error in the monitor target to establish the error as error
Final Action:	Final action at detection of an error
Execute Script before Reactivation:	Whether the pre-reactivation script is executed upon the detection of an error
Execute Script before Failover:	Whether the pre-failover script is executed upon the detection of an error
Execute Script before Final Action:	Whether the pre-final-action script is executed upon the detection of an error
Recovery Target:	Target to be recovered when an error is detected
Recovery Target Type:	Type of target to be recovered when an error is detected
Reactivation Threshold:	The number of reactivations to be made at detection of an error
Failover Target Server:	Determination method of Failover Target Server
Recovery Script Threshold:	The number of times the recovery script is executed upon the detection of an error
Failover Threshold:	The number of failovers to be made at detection of an error
Wait Time to Start Monitoring (sec):	Time to wait before starting of monitoring (in seconds)
Dummy Failure Possibility:	Possibility of Dummy Failure
Collect Dump at Timeout Occurrence:	Whether or not dump of monitor process is collected when timeout occurs
Run Migration Before Run Failover:	Whether or not migration is run before running failover
ODBC Driver Name:	The driver name of the target database
Monitor Action:	Monitor level

Understanding Tuxedo monitor resources

Tuxedo monitor resources monitor Tuxedo that runs on the server.

Tuxedo monitor resources

For the supported Tuxedo versions, see "System requirements for the EXPRESSCLUSTER Server Application supported by the monitoring options" in Chapter 3, "Installation requirements for EXPRESSCLUSTER" in the *Getting Started Guide*.

For target monitoring resource, specify a script resource that can start Tuxedo. Monitoring starts after the target resource is activated; however, if Tuxedo cannot be started right after the target resource is activated, adjust the time by using **Wait Time to Start Monitoring**.

Tuxedo may produce operation logs for each monitoring. Configure the Tuxedo settings if this needs to be adjusted.

Monitoring by Tuxedo monitor resources

Tuxedo monitor resources connect to the Tuxedo and execute API to verify the operation. As a result of monitoring, the following is considered as an error:

- (1) When an error is reported during the connection to the application server and/or the acquisition of the status.

Displaying and changing the Tuxedo monitor resource details

1. Click **Monitors** on the tree view displayed on the left side of the Builder window.
2. List of the monitor resources is displayed in the table view on the right side of the screen. Right click the target Tuxedo monitor resource, and click the **Monitor(special)** tab in the **Monitor Resource Property** window.
3. On the **Monitor(special)** tab, you can display and/or change the detailed settings by following the description below.

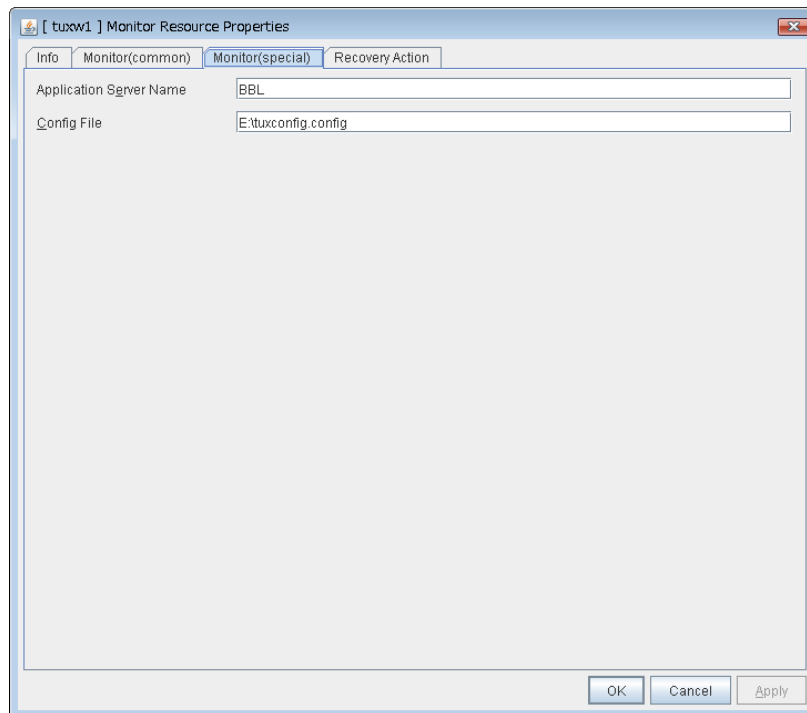

Application Server Name Within 255 bytes **SuspendResume**

Specify the application server name to be monitored. You must specify the name.

Default value: BBL

Config File Within 1023 bytes **SuspendResume**

Specify the placement file name of Tuxedo. You must specify the name.

Default value: None

Displaying the Tuxedo monitor resource properties with the WebManager

1. Start the WebManager (*http://Management IP address or the IP address of the cluster server: port_number* (the default value is 29003)).
2. Click the Tuxedo monitor resources object, , in the tree view. The following information is displayed in the list view.

Tuxedo Monitor Name: tuxw1		Details
Common server1 server2		
Properties	Value	
Comment		
Application Server Name	BBL	
Status	Normal	
Resource Status on Each Server		
Server Name	Status	
server1	Offline	
server2	Normal	

Comment: Comment of the Tuxedo monitor resource
 Application Server Name: Application server name to be monitored
 Status: Status of the Tuxedo monitor resource

Resource Status on Each Server
 Server Name: Server name of each server
 Status: Status of the monitor resource on the given server

When you click **Details**, the following information is displayed in the pop-up dialog box.

Properties	Value
Name	tuxw1
Type	tuxw
Monitor Timing	Activating
Target Resource	appli1
Interval	60
Timeout	120
Do Not Retry at Timeout Occurrence	Off
Do Not Retry at Timeout Occurrence	Off
Retry Count	2
Final Action	Stop the cluster service and shutdown OS
Execute Script Before Reactivation	Off
Execute Script Before Failover	Off
Execute Script before Final Action	Off
Recovery Target	LocalServer
Recovery Target Type	Itself
Recovery Script Threshold	0
Reactivation Threshold	0
Failover Target Server	Stable Server
Failover Threshold	0
Wait Time to Start Monitoring	0
Dummy Failure Possibility	Possible
Collect Dump at Timeout Occurrence	Off
Run Migration Before Run Failover	Off
Config File	E:\tuxconfig.config

Name: Tuxedo monitor resource name
 Type: Monitor resource type

Monitor Timing:	Timing to start monitoring
Target Resource:	Resource to be monitored
Interval (sec):	Interval between monitoring (in seconds)
Timeout (sec):	Timeout for monitoring (in seconds)
Do Not Retry at Timeout Occurrence:	Whether or not to retry when timeout occurs
Do Not Execute Recovery Action at Timeout Occurrence:	Whether or not to execute recovery action when timeout occurs
Retry Count:	The number of retries to be made from detection of an error in the monitor target to establish the error as error
Final Action:	Final action at detection of an error
Execute Script before Reactivation:	Whether the pre-reactivation script is executed upon the detection of an error
Execute Script before Failover:	Whether the pre-failover script is executed upon the detection of an error
Execute Script before Final Action:	Whether the pre-final-action script is executed upon the detection of an error
Recovery Target:	Target to be recovered when an error is detected
Recovery Target Type:	Type of target to be recovered when an error is detected
Recovery Script Threshold:	The number of times the recovery script is executed upon the detection of an error
Reactivation Threshold:	The number of reactivations to be made at detection of an error
Failover Target Server:	Determination method of Failover Target Server
Failover Threshold:	The number of failovers to be made at detection of an error
Wait Time to Start Monitoring (sec):	Time to wait before starting of monitoring (in seconds)
Dummy Failure Possibility:	Possibility of Dummy Failure
Collect Dump at Timeout Occurrence:	Whether or not dump of monitor process is collected when timeout occurs
Run Migration Before Run Failover:	Whether or not migration is run before running failover
Config File:	Configuration file path of Tuxedo

Understanding Websphere monitor resources

Websphere monitor resources monitor WebSphere that runs on the server.

Websphere monitor resources

For the supported WebSphere versions, see "System requirements for the EXPRESSCLUSTER Server Application supported by the monitoring options" in Chapter 3, "Installation requirements for EXPRESSCLUSTER" in the *Getting Started Guide*.

For target monitoring resource, specify a service resource that can start WebSphere. Monitoring starts after the target resource is activated; however, if the database cannot be started right after the target resource is activated, adjust the time by using **Wait Time to Start Monitoring**.

A Java Runtime Environment is required to start monitoring with this command. The application server system uses Java functions. Therefore if Java stalls, it may be recognized as an error.

WebSphere may produce operation logs for each monitoring. Configure the Websphere settings if this needs to be adjusted.

Monitoring by Websphere monitor resources

Websphere monitor resources use the serverStatus.bat command to verify the operation.

As a result of monitoring, the following is considered as an error:

- (1) When an error is reported with the state of the acquired application server.

Displaying and changing the Websphere monitor resource details

1. Click **Monitors** on the tree view displayed on the left side of the Builder window.
2. List of the monitor resources is displayed in the table view on the right side of the screen. Right click the target Websphere monitor resource, and click the **Monitor(special)** tab in the **Monitor Resource Property** window.
3. On the **Monitor(special)** tab, you can display and/or change the detailed settings by following the description below.

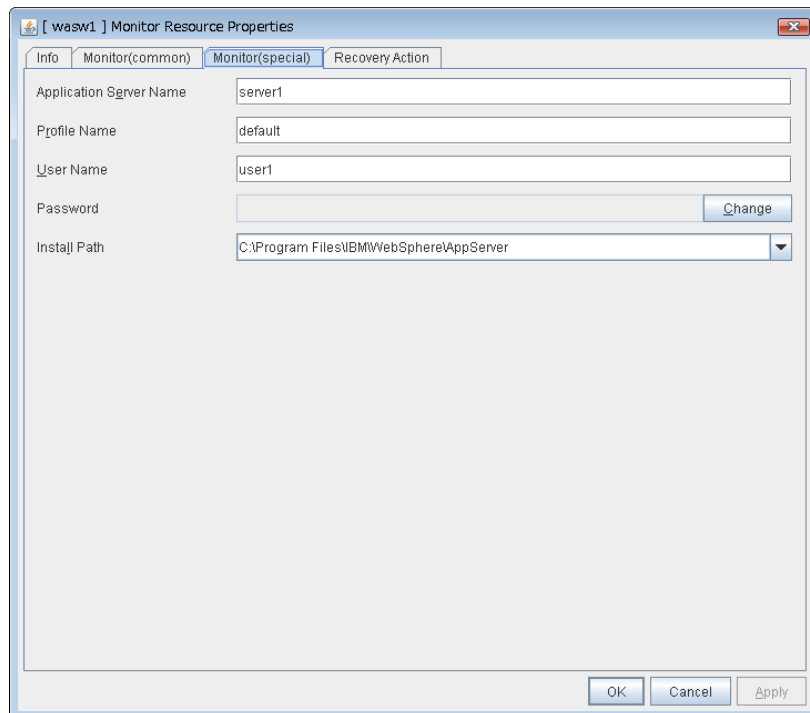

Application Server Name Within 255 bytes **SuspendResume**

Specify the application server name to be monitored. You must specify the name.

Default value: server1

Profile Name Within 1023 bytes **SuspendResume**

Specify the profile name of WebSphere. You must specify the name.

Default value: default

User Name Within 255 bytes **SuspendResume**

Specify the user name of WebSphere. You must specify the name.

Default value: None

Password Within 255 bytes **SuspendResume**

Specify the password of WebSphere. You must specify the password.

Default value: None

Installation path Within 1023 bytes **SuspendResume**

Specify the installation path of WebSphere. You must specify the path.

Default value: C:\Program Files\IBM\WebSphere\AppServer

Displaying the Websphere monitor resource properties with the WebManager

1. Start the WebManager (*http://Management IP address or the IP address of the cluster server: port_number* (the default value is 29003)).
2. Click the Websphere monitor resources object, , in the tree view. The following information is displayed in the list view.

Websphere Monitor Name: wasw1		Details
<div style="display: flex; border-bottom: 1px solid black;"> <div style="border-right: 1px solid black; padding: 2px 5px;">Common</div> <div style="border-right: 1px solid black; padding: 2px 5px;">server1</div> <div style="padding: 2px 5px;">server2</div> </div>		
Properties	Value	
Comment		
Application Server Name	server1	
Status	Normal	
Resource Status on Each Server		
Server Name	Status	
server1	Normal	
server2	Offline	

Comment: Comment of the Websphere monitor resource

Application Server Name: Application server name to be monitored

Status: Status of the Websphere monitor resource

Resource Status on Each Server

Server Name: Server name of each server

Status: Status of the monitor resource on the given server

When you click **Details**, the following information is displayed in the pop-up dialog box.

Properties	Value
Name	wasw1
Type	wasw
Monitor Timing	Activating
Target Resource	appli1
Interval	60
Timeout	120
Do Not Retry at Timeout Occurrence	Off
Do Not Execute Recovery Action at Timeout Occurrence	Off
Retry Count	2
Final Action	Stop the cluster service and shutdown OS
Execute Script Before Reactivation	Off
Execute Script Before Failover	Off
Execute Script before Final Action	Off
Recovery Target	LocalServer
Recovery Target Type	Itself
Recovery Script Threshold	0
Reactivation Threshold	0
Failover Target Server	Stable Server
Failover Threshold	0
Wait Time to Start Monitoring	0
Dummy Failure Possibility	Possible
Collect Dump at Timeout Occurrence	Off
Run Migration Before Run Failover	Off
Profile Name	default
Install Path	C:\Program Files\IBM\WebSphere\AppServer

- Name: Websphere monitor resource name
- Type: Monitor resource type
- Monitor Timing: Timing to start monitoring
- Target Resource: Resource to be monitored
- Interval (sec): Interval between monitoring (in seconds)
- Timeout (sec): Timeout for monitoring (in seconds)
- Do Not Retry at Timeout Occurrence: Whether or not to retry when timeout occurs
- Do Not Execute Recovery Action at Timeout Occurrence: Whether or not to execute recovery action when timeout occurs
- Retry Count: The number of retries to be made from detection of an error in the monitor target to establish the error as error
- Final Action: Final action at detection of an error
- Execute Script before Reactivation: Whether the pre-reactivation script is executed upon the detection of an error
- Execute Script before Failover: Whether the pre-failover script is executed upon the detection of an error
- Execute Script before Final Action: Whether the pre-final-action script is executed upon the detection of an error
- Recovery Target: Target to be recovered when an error is detected
- Recovery Target Type: Type of target to be recovered when an error is detected
- Reactivation Threshold: The number of reactivations to be made at detection of an error
- Failover Target Server: Determination method of Failover Target Server
- Recovery Script Threshold: The number of times the recovery script is executed upon the detection of an error
- Failover Threshold: The number of failovers to be made at detection of an error
- Wait Time to Start Monitoring (sec): Time to wait before starting of monitoring (in seconds)
- Dummy Failure Possibility: Possibility of Dummy Failure
- Collect Dump at Timeout Occurrence: Whether or not dump of monitor process is collected when timeout occurs
- Run Migration Before Run Failover: Whether or not migration is run before running failover

Profile Name
Installation path

Profile name of WebSphere
Install path of WebSphere

Understanding Weblogic monitor resources

Weblogic monitor resources monitor WebLogic that runs on the server.

Weblogic monitor resources

For the supported WebLogic versions, see "System requirements for the EXPRESSCLUSTER Server Application supported by the monitoring options" in Chapter 3, "Installation requirements for EXPRESSCLUSTER" in the *Getting Started Guide*.

If WebLogic cannot run immediately after startup, it is recognized as an error. To prevent this, adjust **Wait Time to Start Monitoring**. Or, make sure that WebLogic starts first (for example, by specifying the script resource that starts WebLogic as the monitor target resource).

A Java Runtime Environment is required to start monitoring with this command. The application server system uses Java functions. Therefore if Java stalls, it may be recognized as an error.

WebLogic may produce operation logs for each monitoring. Configure the WebLogic settings if this needs to be adjusted.

Monitoring by Weblogic monitor resources

Weblogic monitor resources use the `webLogic.Admin (Ping)` command to verify the operation.

Monitors the application server by performing **connect** with the **webLogic.WLST** command.

As a result of monitoring, the following is considered as an error:

- (1) When an error is reported as the response to **connect**.

Displaying and changing the Weblogic monitor resource details

1. Click **Monitors** on the tree view displayed on the left side of the Builder window.
2. List of the monitor resources is displayed in the table view on the right side of the screen. Right click the target Weblogic monitor resource, and click the **Monitor(special)** tab in the **Monitor Resource Property** window.
3. On the **Monitor(special)** tab, you can display and/or change the detailed settings by following the description below.

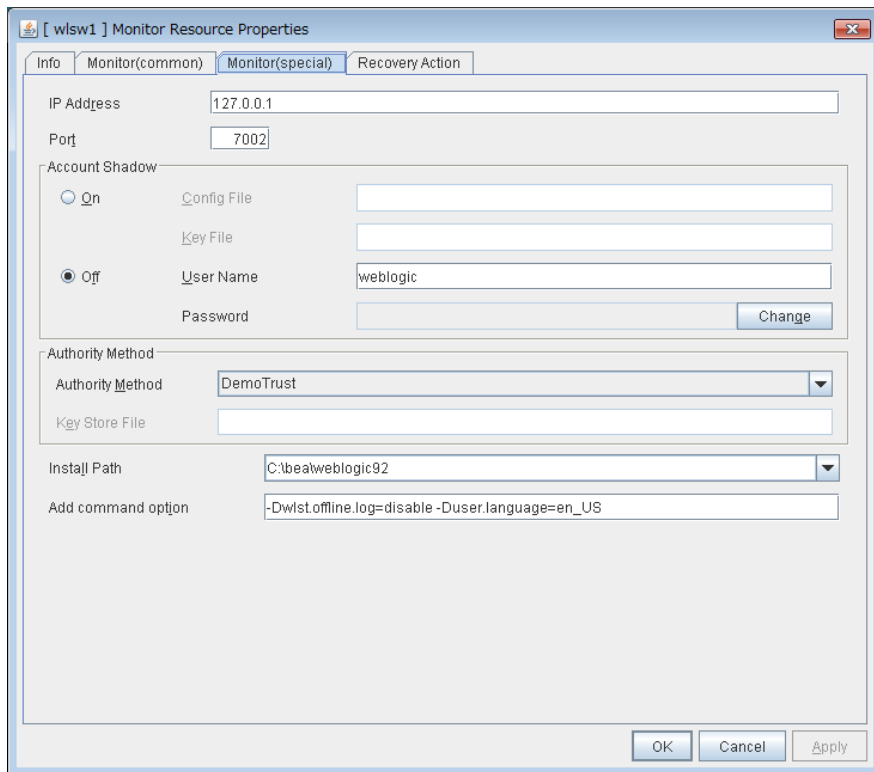

IP Address Within 80 bytes **SuspendResume**

Specify the IP address of the server to be monitored. You must specify the IP address.

Default value: 127.0.0.1

Port (1 to 65535) **SuspendResume**

Specify the port number used to connect to the server. You must specify the number.

Default value: 7002

Account Shadow **SuspendResume**

When you specify a user name and a password directly, select **Off**. If not, select **On**. You must specify the setting.

Default value: Off

Config File Within 1023 bytes **SuspendResume**

Specify the file in which the user information is saved. You must specify the file if **Account Shadow** is **On**.

Default value: None

Key File Within 1023 bytes **SuspendResume**

Specify the file in which the password required to access to a config file path is saved. Specify the full path of the file. You must specify the file if **Account Shadow** is **On**.

Default value: None

User Name Within 255 bytes **SuspendResume**

Specify the user name of WebLogic. You must specify the file if **Account Shadow** is **Off**.

Default value: weblogic

Password Within 255 bytes **SuspendResume**

Specify the password of WebLogic.

Default value: weblogic

Authority Method **SuspendResume**

Specify the authentication method when connecting to an application server. You must specify the method.

Default value: DemoTrust

Key Store File Within 1023 bytes **SuspendResume**

Specify the authentication file when authenticating SSL. You must specify this when the authentication method is **CustomTrust**.

Default value: None

Installation path Within 1023 bytes **SuspendResume**

Specify the installation path of WebLogic. You must specify the path.

Default value: C:\bea\weblogic92

Add command option (within 1023 bytes) **SuspendResume**

Set this value when changing the option to be passed to the `webLogic.WLST` command.

Default value: -Dwlst.offline.log=disable -Duser.language=en_US

Displaying the Weblogic monitor resource properties with the WebManager

1. Start the WebManager (*http://Management IP address or the IP address of the cluster server: port_number* (the default value is 29003)).
2. Click the Weblogic monitor resources object, , in the tree view. The following information is displayed in the list view.

Weblogic Monitor Name: wlsw1		Details	
Common		server1	server2
Properties	Value		
Comment			
IP Address	127.0.0.1		
Port	7002		
Status	Normal		
Resource Status on Each Server			
Server Name	Status		
server1	Offline		
server2	Normal		

Comment: Comment of the Weblogic monitor resource
IP Address: IP address of the Weblogic monitor resource
Port: Port number of the Weblogic monitor resource
Status: Status of the Weblogic monitor resource

Resource Status on Each Server

Server Name: Server name of each server
Status: Status of the monitor resource on the given server

When you click **Details**, the following information is displayed in the pop-up dialog box..

Properties	Value
Name	wlsw1
Type	wlsw
Monitor Timing	Activating
Target Resource	appli1
Interval	60
Timeout	120
Do Not Retry at Timeout Occurrence	Off
Do Not Execute Recovery Action at Timeout Occurrence	Off
Retry Count	2
Final Action	Stop the cluster service and shutdown OS
Execute Script Before Reactivation	Off
Execute Script Before Failover	Off
Execute Script before Final Action	Off
Recovery Target	LocalServer
Recovery Target Type	Itself
Recovery Script Threshold	0
Reactivation Threshold	0
Failover Target Server	Stable Server
Failover Threshold	0
Wait Time to Start Monitoring	0
Dummy Failure Possibility	Possible
Collect Dump at Timeout Occurrence	Off
Run Migration Before Run Failover	Off
Authority Method	DemoTrust
Install Path	C:\beatweblogic92
Additional Command Option	-Dwlst.offline.log=disable -Duser.language=en_US

Name:	Weblogic monitor resource name
Type:	Monitor resource type
Monitor Timing:	Timing to start monitoring
Target Resource:	Resource to be monitored
Interval (sec):	Interval between monitoring (in seconds)
Timeout (sec):	Timeout for monitoring (in seconds)
Do Not Retry at Timeout Occurrence:	Whether or not to retry when timeout occurs
Do Not Execute Recovery Action at Timeout Occurrence:	Whether or not to execute recovery action when timeout occurs
Retry Count:	The number of retries to be made from detection of an error in the monitor target to establish the error as error
Final Action:	Final action at detection of an error
Execute Script before Reactivation:	Whether the pre-reactivation script is executed upon the detection of an error
Execute Script before Failover:	Whether the pre-failover script is executed upon the detection of an error
Execute Script before Final Action:	Whether the pre-final-action script is executed upon the detection of an error
Recovery Target:	Target to be recovered when an error is detected
Recovery Target Type:	Type of target to be recovered when an error is detected
Recovery Script Threshold:	The number of times the recovery script is executed upon the detection of an error
Reactivation Threshold:	The number of reactivations to be made at detection of an error
Failover Target Server:	Determination method of Failover Target Server
Failover Threshold:	The number of failovers to be made at detection of an error
Wait Time to Start Monitoring (sec):	Time to wait before starting of monitoring (in seconds)
Dummy Failure Possibility:	Possibility of Dummy Failure
Collect Dump at Timeout Occurrence:	Whether or not dump of monitor process is collected when timeout occurs
Run Migration Before Run Failover:	Whether or not migration is run before running failover
Authority Method	Authority method of WebLogic
Installation path	Install path of WebLogic
Additional Command Option:	Option to be passed to the <code>webLogic.WLST</code> command

Understanding WebOTX monitor resources

WebOTX monitor resources monitor WebOTX that runs on the server.

WebOTX monitor resources

For the supported WebOTX versions, see "System requirements for the EXPRESSCLUSTER Server Application supported by the monitoring options" in Chapter 3, "Installation requirements for EXPRESSCLUSTER" in the *Getting Started Guide*.

For target monitoring resource, specify a script resource that can start WebOTX. Monitoring starts after the target resource is activated; however, if WebOTX cannot be started right after the target resource is activated, adjust the time by using **Wait Time to Start Monitoring**.

A Java environment is required to start monitoring with this command. The application server system uses Java functions. Therefore if Java stalls, it may be recognized as an error.

WebOTX may produce operation logs for each monitoring. Configure the WebOTX settings if this needs to be adjusted.

Monitoring by WebOTX monitor resources

WebOTX monitor resources use the otxadmin.bat command to verify the operation. As a result of monitoring, the following is considered as an error:

- (1) When an error is reported with the state of the acquired application server.

Displaying and changing the WebOTX monitor resource details Websphere

1. Click **Monitors** on the tree view displayed on the left side of the Builder window.
2. List of the monitor resources is displayed in the table view on the right side of the screen. Right click the target Weblogic monitor resource, and click the **Monitor(special)** tab in the **Monitor Resource Property** window.
3. On the **Monitor(special)** tab, you can display and/or change the detailed settings by following the description below.

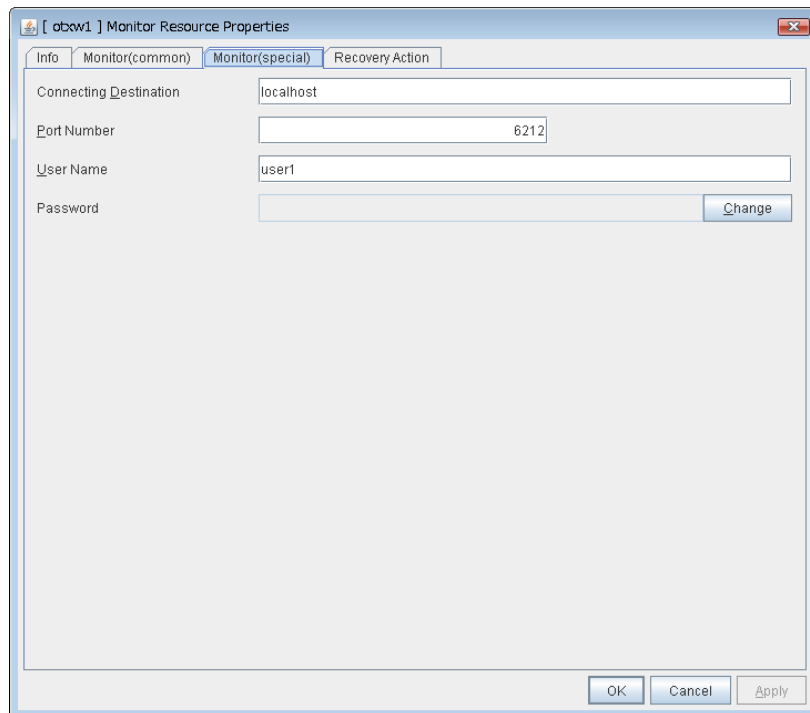

Connecting Destination Within 255 bytes **SuspendResume**

Specify the server name of the server to be monitored. You must specify the name.

Default value: localhost

Port Number (1 to 65535) **SuspendResume**

Specify the port number used to connect to the server. You must specify the number.

When monitoring a WebOTX user domain, specify the management port number for the WebOTX domain. The management port number is the number which was set for "domain.admin.port" of <domain_name>.properties when the domain was created. Refer to the WebOTX documents for details of <domain_name>.properties

Default value: 6212

User Name Within 255 bytes **SuspendResume**

Specify the user name of WebOTX. You must specify the name.

When monitoring a WebOTX user domain, specify the login user name for the WebOTX domain.

Default value: None

Password Within 255 bytes **SuspendResume**

Specify the password of WebOTX.

Default value: None

Displaying the WebOTX monitor resource properties with the WebManager

1. Start the WebManager (*http://Management IP address or the IP address of the cluster server: port_number* (the default value is 29003)).
2. Click the WebOTX monitor resources object, , in the tree view. The following information is displayed in the list view.

WebOTX Monitor Name: otw1		Details	
Common		server1	server2
Properties	Value		
Comment			
Connecting Destination	localhost		
Port	6212		
Status	Normal		
Resource Status on Each Server			
Server Name	Status		
server1	Normal		
server2	Offline		

Comment: Comment of the Weblogic monitor resource
 Connecting Destination: Server name for connecting of the WebOTX monitor resource
 Port: Port number of the WebOTX monitor resource
 Status: Status of the WebOTX monitor resource

Resource Status on Each Server
 Server Name: Server name of each server
 Status: Status of the monitor resource on the given server

When you click **Details**, the following information is displayed in the pop-up dialog box.

Properties	Value
Name	obw1
Type	obw
Monitor Timing	Activating
Target Resource	appli1
Interval	60
Timeout	120
Do Not Retry at Timeout Occurrence	Off
Do Not Execute Recovery Action at Timeout Occurrence	Off
Retry Count	1
Final Action	Stop the cluster service and shutdown OS
Execute Script Before Reactivation	Off
Execute Script Before Failover	Off
Execute Script before Final Action	Off
Recovery Target	LocalServer
Recovery Target Type	Itself
Recovery Script Threshold	0
Reactivation Threshold	0
Failover Target Server	Stable Server
Failover Threshold	0
Wait Time to Start Monitoring	0
Dummy Failure Possibility	Possible
Collect Dump at Timeout Occurrence	Off
Run Migration Before Run Failover	Off

- Name: WebOTX monitor resource name
- Type: Monitor resource type
- Monitor Timing: Timing to start monitoring
- Target Resource: Resource to be monitored
- Interval (sec): Interval between monitoring (in seconds)
- Timeout (sec): Timeout for monitoring (in seconds)
- Do Not Retry at Timeout Occurrence: Whether or not to retry when timeout occurs
- Do Not Execute Recovery Action at Timeout Occurrence: Whether or not to execute recovery action when timeout occurs
- Retry Count: The number of retries to be made from detection of an error in the monitor target to establish the error as error
- Final Action: Final action at detection of an error
- Execute Script before Reactivation: Whether the pre-reactivation script is executed upon the detection of an error
- Execute Script before Failover: Whether the pre-failover script is executed upon the detection of an error
- Execute Script before Final Action: Whether the pre-final-action script is executed upon the detection of an error
- Recovery Target: Target to be recovered when an error is detected
- Recovery Target Type: Type of target to be recovered when an error is detected
- Recovery Script Threshold: The number of times the recovery script is executed upon the detection of an error
- Reactivation Threshold: The number of reactivations to be made at detection of an error
- Failover Target Server: Determination method of Failover Target Server
- Failover Threshold: The number of failovers to be made at detection of an error
- Wait Time to Start Monitoring (sec): Time to wait before starting of monitoring (in seconds)
- Dummy Failure Possibility: Possibility of Dummy Failure
- Collect Dump at Timeout Occurrence: Whether or not dump of monitor process is collected when timeout occurs
- Run Migration Before Run Failover: Whether or not migration is run before running failover

Understanding JVM monitor resources

JVM monitor resources monitor information about the utilization of resources that are used by Java VM or an application server running on a server.

Note on JVM monitor resources

The **Java installation path** on the **JVM monitor** tab of **Cluster Properties** must be set before adding JVM monitor resource.

For a target resource, specify an application server running on Java VM such as WebLogic Server or WebOTX. As soon as the JVM monitor resource has been activated, the Java Resource Agent starts monitoring, but if the target (WebLogic Server or WebOTX) cannot start running immediately after the activation of the JVM monitor resource, use **Wait Time to Start Monitoring** to compensate.

The setting of **Monitor(common)** tab-**Retry Count** is invalid. When you'd like to delay error detection, please change the setting of **Cluster Properties-JVM monitor** tab-**Resource Measurement Settings [Common]-Retry Count**.

The status of the JVM monitor resource is "Warning" from when monitoring is started to when the monitoring processing is actually performed. In this status, the following message is output to the alert log. Ignore this message because it only indicates just that monitoring is in preparation.
Monitor jraw is in the warning status. (100 : not ready for monitoring.)

Monitoring by JVM monitor resources

JVM monitor resource monitors the following:

Monitors application server by using JMX (Java Management Extensions).

The monitor resource determines the following results as errors:

- Target Java VM or application server cannot be connected
- The value of the used amount of resources obtained for the Java VM or application server exceeds the user-specified threshold a specified number of times (error decision threshold) consecutively

As a result of monitoring, an error is regarded as having been solved if:

- The used amount of resources obtained for the Java VM or application server remains below the user-specified threshold the number of times specified by the error decision threshold.

Note:

Collect Cluster Logs in the WebManager **Tools** menu does not handle the configuration file and log files of the target (WebLogic or WebOTX).

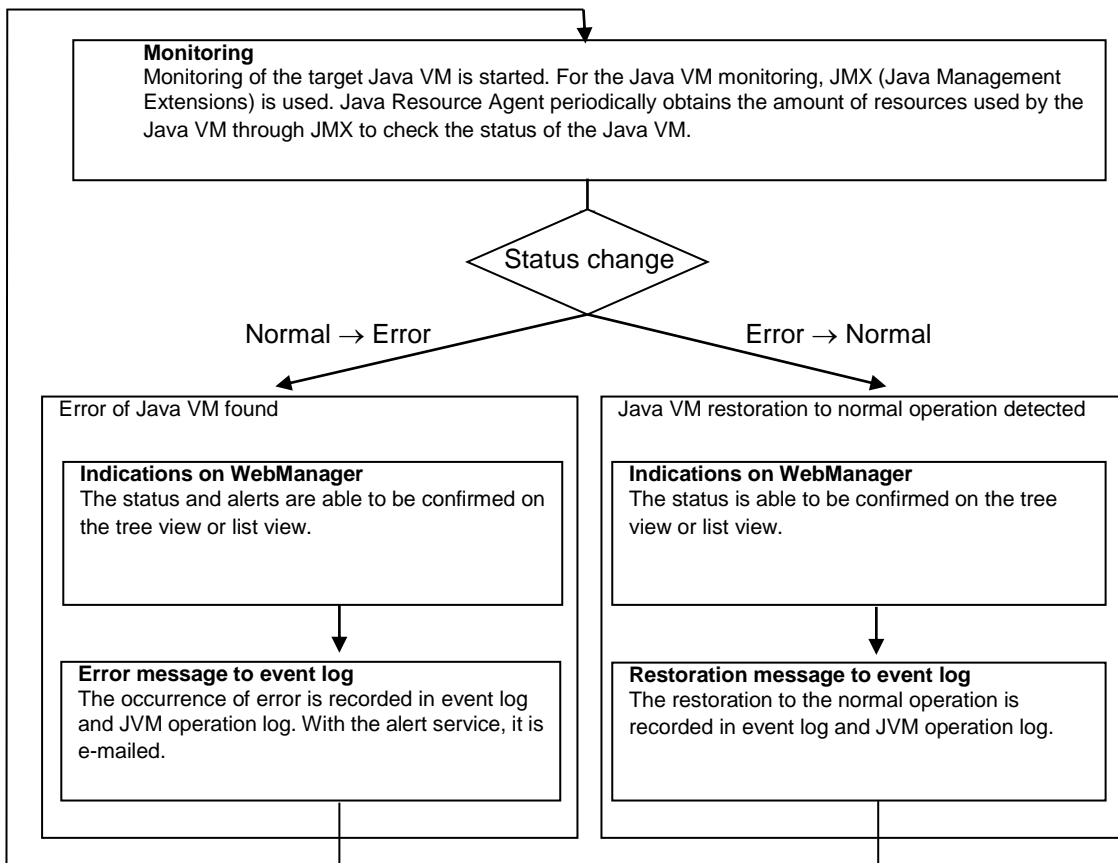

The standard operations when the threshold is exceeded are as described below.

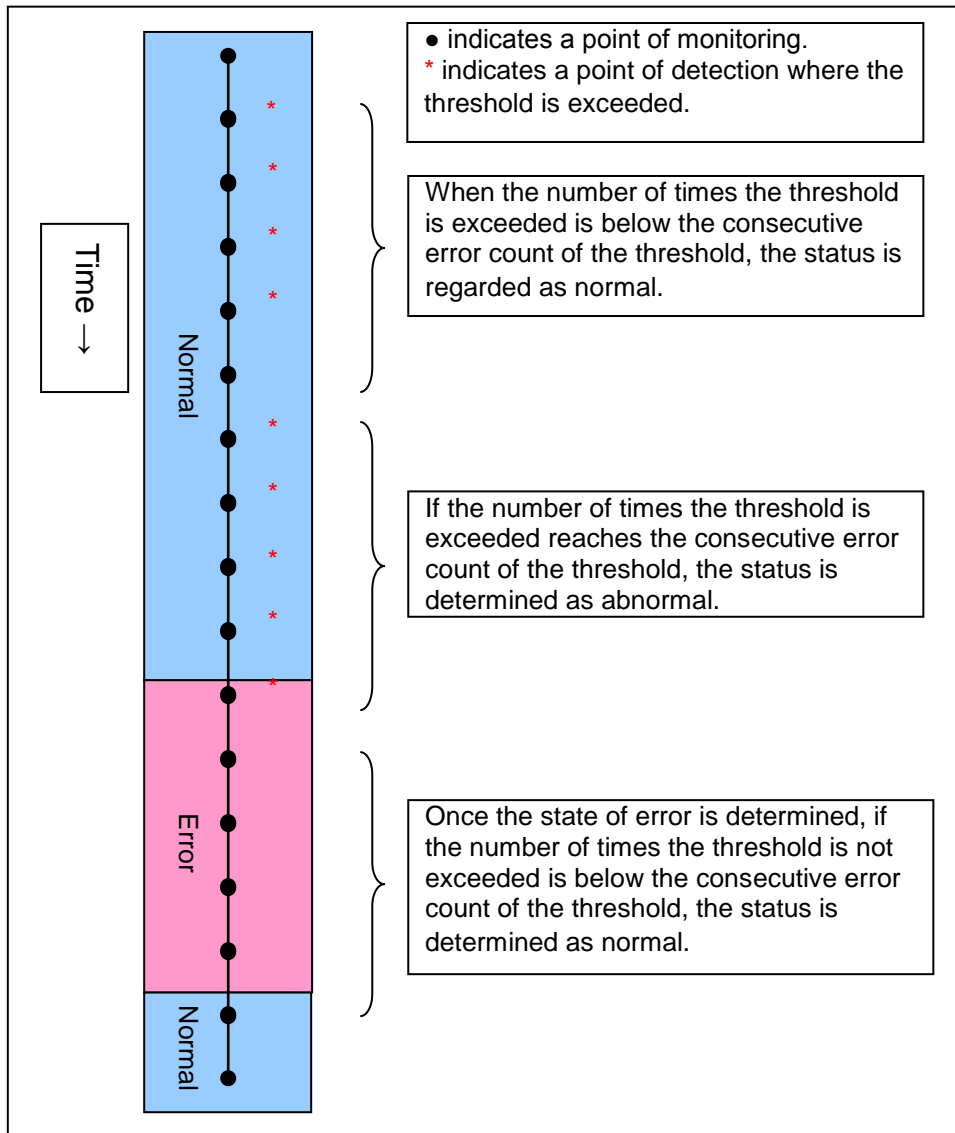

The operations performed if an error persists are as described below.

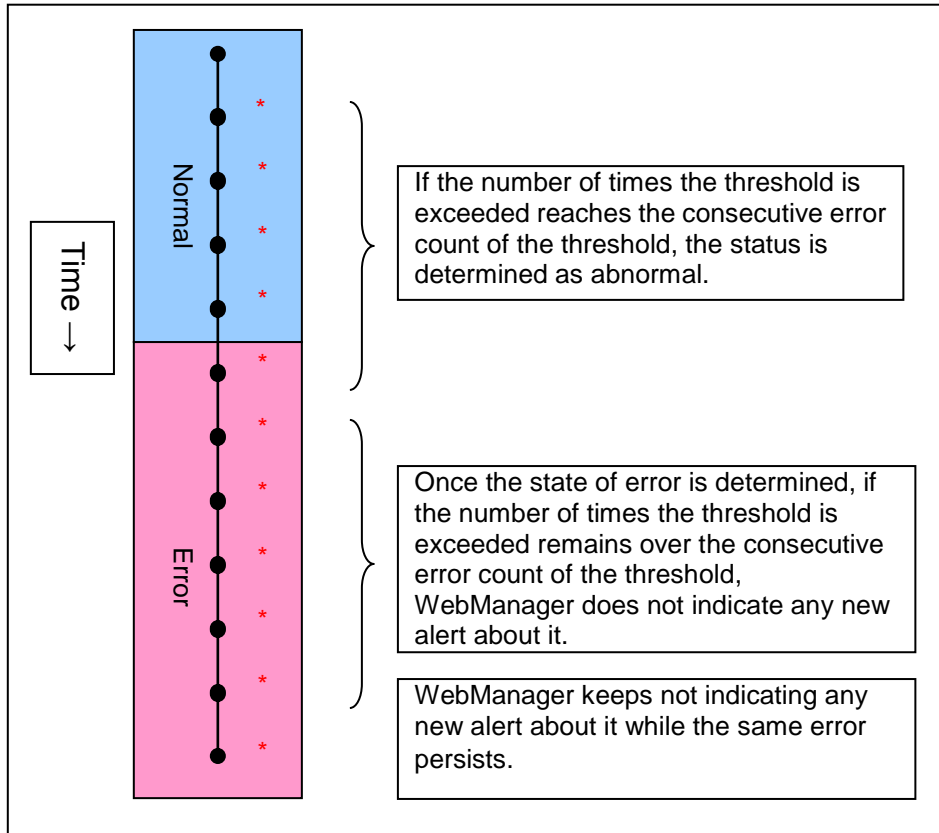

The following example describes the case of monitoring Full GC (Garbage Collection). The JVM monitor resource recognizes a monitor error if Full GC is detected consecutively the number of times specified by the error threshold. In the following chart, * indicates that Full GC is detected during JVM monitoring when the error threshold is set to 5 (times). Full GC has a significant influence on the system, thus the recommended error threshold is 1 time.

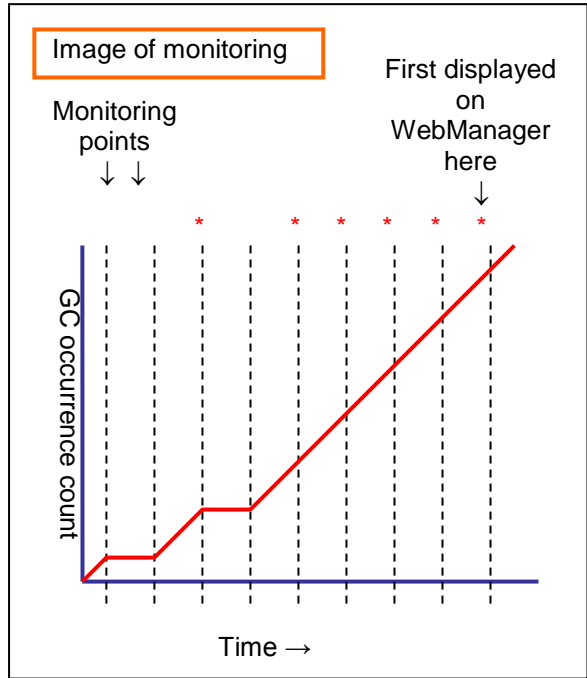

Linking with the load balancer (JVM monitor health check function)

Target load balancer: Load balancer with health check function for HTML files

JVM monitor resources can link with the load balancer. This section describes an example of linking when WebOTX is used as the application to be monitored. The load balancer linkage provides a JVM monitor health check function and target Java VM load calculation function. To link with the BIG-IP Local Traffic Manager, see “Linking with the BIG-IP Local Traffic Manager.”

Distributed nodes are servers that are subject to load balancing, while the distributed node module is installed in the distributed nodes. The distributed node module is included in Express5800/LB400*, MIRACLE LoadBalancer. For Express5800/LB400*, refer to the *Express5800/LB400* User's Guide (Software)*. For load balancers other than Express5800/LB400*, refer to the relevant manual.

To use the function, configure the settings through the Builder cluster property→**JVM Monitor** tab→**Load Balancer Linkage Settings** dialog box.

When a load balancing system is configured with the load balancer on the server, the JVM monitoring renames the HTML file specified by **HTML File Name** to the name specified by **HTML Renamed File Name** upon the detection of a WebOTX error (for example, exceeding the threshold for collected information).

The JVM monitoring halts for the wait time, or 20 seconds, after renaming the HTML file. The wait time is intended to prevent WebOTX from being restarted before the load balancer finishes disconnecting the distributed node.

Once the JVM monitoring detects the normality of WebOTX (e.g., the threshold specified for the collected information is not exceeded after reconnection) after WebOTX rebooting, the HTML file name set with **HTML Renamed File Name** is restored to that specified by **HTML File Name**.

The load balancer periodically health-checks the HTML file, and if a health check fails, the distributed node is determined to be not alive, so that the load balancer disconnects that distributed node. In the case of Express5800/LB400*, configure the health check interval, health check timeout, and retry count to determine the node down state by the health check with the health check (distributed node) interval parameter, HTTP health check timeout parameter, and health check (distributed node) count parameter, that are accessible from **ManagementConsole** for the load balancer→**LoadBalancer**→**System Information**. For how to configure load balancers other than Express5800/LB400*, refer to the relevant manual.

Configure the parameters using the following as a reference.

20-second wait time \geq (health check (distributed node) interval + HTTP health check timeout) x health check (distributed node) count

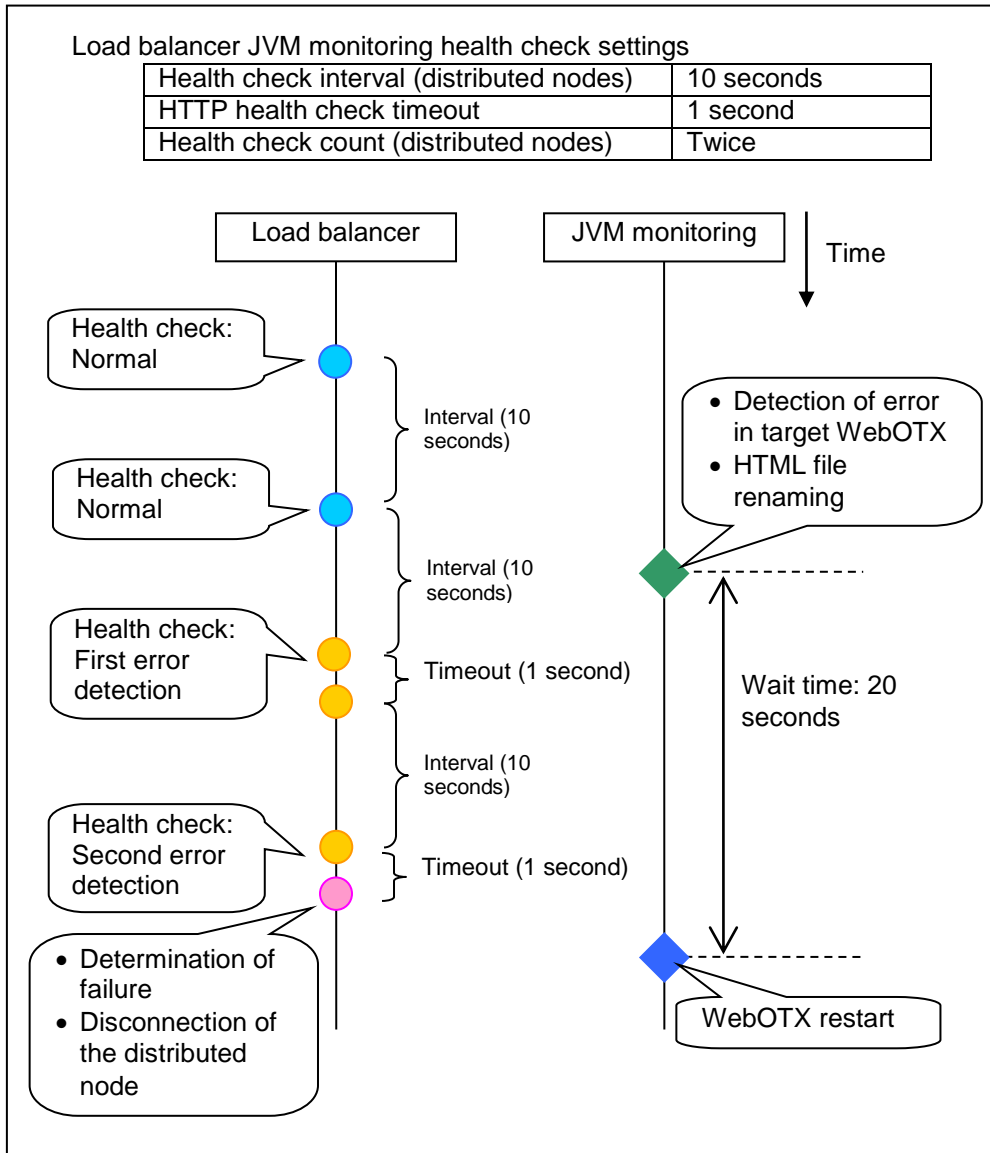

Settings must also be specified on the load balancer side.

For Express5800/LB400*, specify load dispersion environment settings by using the Management Console of the load balancer. For setting details, refer to the *Express5800/LB400* User's Guide (Software)*.

For a load balancer other than Express5800/LB400*, refer to the relevant manual.

Linking with the load balancer (target Java VM load calculation function)

Target load balancer: Express5800/LB400*, MIRACLE LoadBalancer

JVM monitor resources can link with the load balancer. The load balancer linkage provides a JVM monitor health check function and target Java VM load calculation function.

To link with the BIG-IP Local Traffic Manager, see “Linking with the BIG-IP Local Traffic Manager.”

Distributed nodes are servers that are subject to load balancing, while the distributed node module is installed in the distributed node. The distributed node module is included in Express5800/LB400*, MIRACLE LoadBalancer. For Express5800/LB400*, refer to the *Express5800/LB400* User’s Guide (Software)*. For load balancers other than Express5800/LB400*, refer to the relevant manual.

To use the function, configure the settings through the **Monitor(special)** tab. The CPU load-dependent weighting function of the load balancer is linked.

- **Properties - Monitor(special) tab -> Tuning property - Memory dialog box - Monitor Heap Memory Rate - Total Usage**
- **Properties - Monitor(special) tab -> Tuning property - Load Balancer Linkage dialog box - Memory Pool Monitor**

According to the following steps, first install the distributed node module on each server.

Note:

Execute the command from an account having the Administrator privilege.

By using a registry editor, Please set the following registry key value Execute

IA32 version

Registry key: HKEY_LOCAL_MACHINE\SOFTWARE\NEC\IPLB4\Parameter\JVMSave r...	Description	Value	Default
Enabled	Enables or disables the function.	0 or 1 0: Disable 1: Enable	0
JVMSaverCheckInterval	Specify the execution interval for the target Java VM load calculation command, in seconds.	1 to 2147483646	120 (seconds)
ActionTimeout	Specify the timeout for the target Java VM load calculation command, in seconds.	1 to 2147483646	1800 (seconds)
CommandPath	Specify the path for the target Java VM load calculation command.	Please specify below. For Windows Server 2003, Windows Server 2008 ("\" please enclose):	none

Registry key: HKEY_LOCAL_MACHINE\ SOFTWARE\NEC\ IPLB4\Parameter\JVMSave r\...	Description	Value	Default
		"<EXPRESSCLU STER install path> \ha\jra\bin\clp_jra_1 badmin.bat" weight	

x86_64 version

Registry key: HKEY_LOCAL_MACHINE\ SOFTWARE\ Wow6432Node\NEC\IPLB4\ Parameter\ JVMSaver\...	Description	Value	Default
Enabled	Enables or disables the function.	0 or 1 0: Disable 1: Enable	0
JVMSaverCheckInterval	Specify the execution interval for the target Java VM load calculation command, in seconds.	1 to 2147483646	120 (seconds)
ActionTimeout	Specify the timeout for the target Java VM load calculation command, in seconds.	1 to 2147483646	1800 (seconds)
CommandPath	Specify the path for the target Java VM load calculation command.	Please specify below. For Windows Server 2003, Windows Server 2008 ("\" please enclose): "<EXPRESSCLU STER install path> \ha\jra\bin\clp_jra_1 badmin.bat" weight For Windows Server 2008 R2: <EXPRESSCLUS TER install path> \ha\jra\bin\clp_jra_1 badmin.bat weight	none

The JVM monitoring calculates the load on the target Java VM according to the information obtained about the Java memory.

Obtain the Java VM load from the following expression. The threshold is the value obtained by multiplying the entire amount of the Java heap area by the use ratio set with **Monitor(special)** tab - **Tuning** property - **Memory** tab - **Monitor Heap Memory Rate - Total Usage**.

$$\text{Java VM load (\%)} = \text{current memory usage (MB)} \times 100 / \text{threshold (MB)}$$

For the distributed node module installed on a server on which JVM monitoring is running, commands are periodically executed to compare the obtained target Java VM load with the CPU load obtained separately, and to notify the load balancer of the higher load value as a CPU load. The load balancer distributes the traffic (requests) to the appropriate servers according to the CPU load of the distributed node.

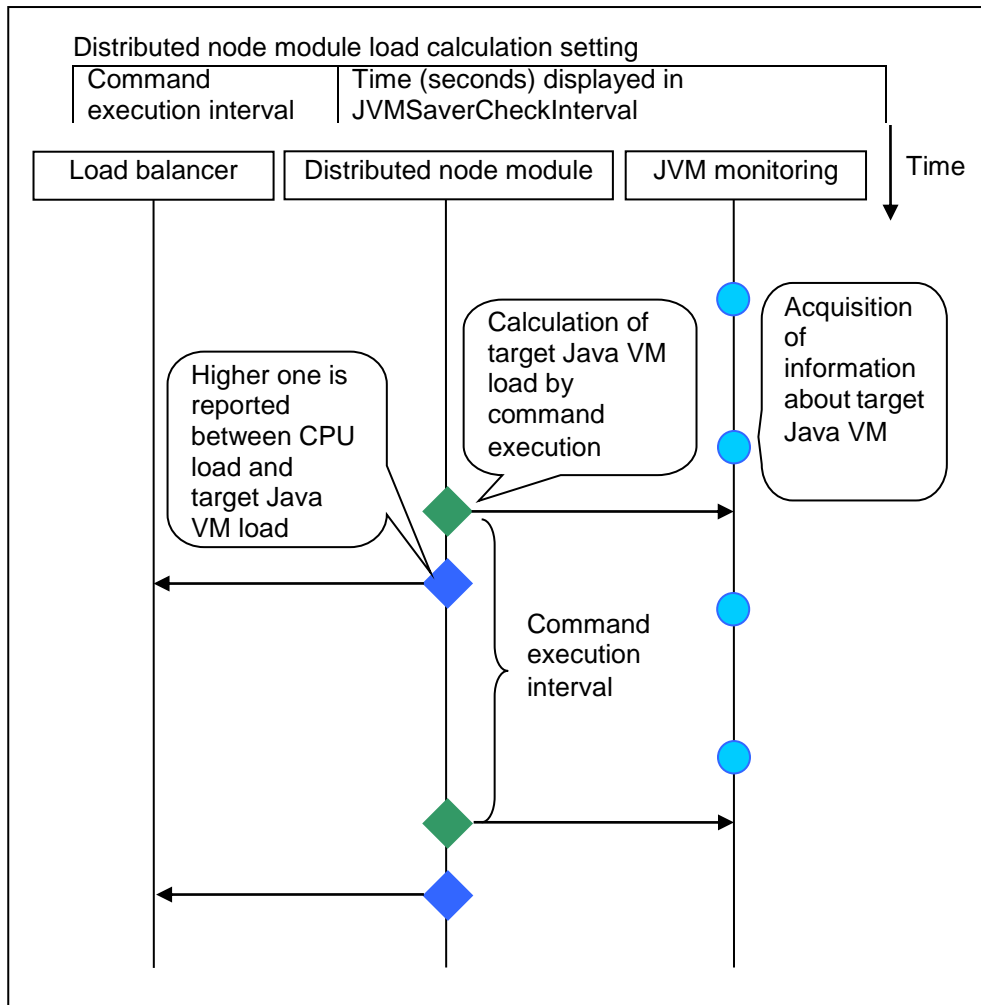

Settings must also be specified on the load balancer side.

In the case of Express5800/LB400*, specify load dispersion environment settings by using the Management Console of the load balancer. For setting details, refer to the *Express5800/LB400* User's Guide (Software)*.

For load balancers other than Express5800/LB400*, refer to the relevant manual.

The dispersed node module must be restarted in order to apply the JVM monitor settings. The module must also be restarted when changing the setting of the load calculation function of the Java VM to be monitored from enabled to disabled and vice versa.

If you are using Windows, restart the iplb4 service by clicking **Start**→**Control Panel**→**Management Tools**→**Services**.

Linking with the BIG-IP Local Traffic Manager

Target load balancer: BIG-IP Local Traffic Manager

The JVM monitor resource can link with BIG-IP LTM. Hereafter, the explanation assumes the use of Tomcat as the application server to be monitored. Linkage with BIG-IP LTM offers the distributed node control function and the target Java VM load calculation function.

The linkage between BIG-IP LTM and the JVM monitor resource is realized with the BIG-IP series API (iControl).

The distributed node is the load distribution server, and the linkage module is that which is installed in each distributed node. The linkage module is contained in Java Resource Agent.

To use the distributed node control function, specify the setting with **Builder Cluster Properties -> JVM monitor tab -> Load Balancer Linkage Settings** dialog box, **JVM monitor resource Properties - Monitor(special) tab - Tuning property - Load Balancer Linkage tab**.

To use the target Java VM load calculation function, specify the setting with **Builder cluster properties -> JVM monitor tab -> Load Balancer Linkage Settings** dialog box.

The following BIG-IP LTM linkage error message is output to the JVM operation log. For details, see “JVM monitor resource log output messages.”

```
Error: Failed to operate clpjra_bigip.[error code]
```

If the relevant server configures the BIG-IP LTM load distribution system, when the JVM monitor detects a Tomcat failure (for example: the amount of collection information exceeds the specified threshold), iControl is used to update the BIG-IP LTM distributed node status from “enable” to “disable.”

After updating the status of the distributed node of BIG-IP LTM, the JVM monitor waits until the number of connections of the distributed node falls to 0. After waiting, it executes **Restart Command** specified on the **JVM monitor resource Properties - Monitor(special) tab -> Tuning property - Load Balancer Linkage tab**. It does not execute the action specified by **Restart Command** if the number of connections of the distributed node does not fall to 0, even if **Timeout** elapses, as specified on the **JVM monitor resource Properties - Monitor(special) tab -> Tuning property - Load Balancer Linkage tab**.

When the JVM monitor detects a Tomcat failure recovery, it uses iControl to update the status of the BIG-IP LTM distributed node from “disable” to “enable.” In this case, it does not execute the action specified by **Restart Command** specified on the JVM monitor resource **Properties - Monitor(special) tab -> Tuning property - Load Balancer Linkage tab**.

If the distributed node status is “disable,” BIG-IP LTM determines the distributed node to be down and therefore disconnects it. Use of the distributed node control function requires no related setting for BIG-IP LTM.

The distributed node status is updated by BIG-IP LTM when the JVM monitor detects a failure or failure recovery. Therefore, after the failover generated by an operation other than JVM monitoring, the distributed node status of BIG-IP LTM may be “enable.”

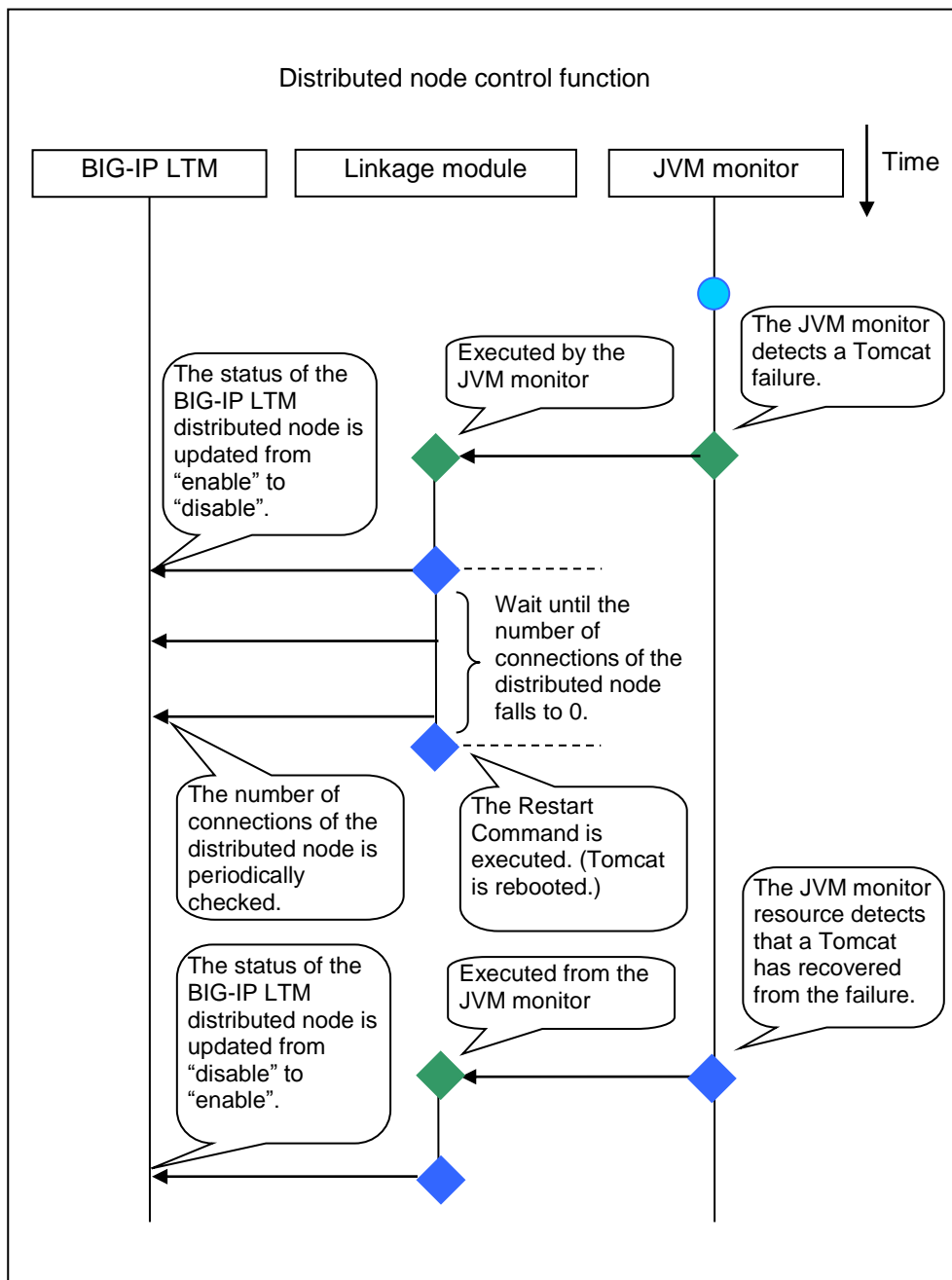

The JVM monitoring calculates the load on the target Java VM according to the information obtained about the Java memory.

Obtain the Java VM load from the following expression. The threshold is the value obtained by multiplying the entire amount of the Java heap area by the use ratio set with **Monitor(special)** tab - **Tuning** property - **Memory** tab - **Monitor Heap Memory Rate** - **Total Usage**.

$$\text{Java VM load (\%)} = \text{current memory usage (MB)} \times 100 / \text{threshold (MB)}$$

The linkage module installed on the server on which the JVM monitor runs executes a command at regular intervals, and reports the load collected on the target Java VM to BIG-IP LTM. BIG-IP LTM distributes the traffic (request) to the optimal server according to the load status of Java VM of the distributed node.

Set the following EXPRESSCLUSTER settings with the Builder.

- **JVM monitor resource**

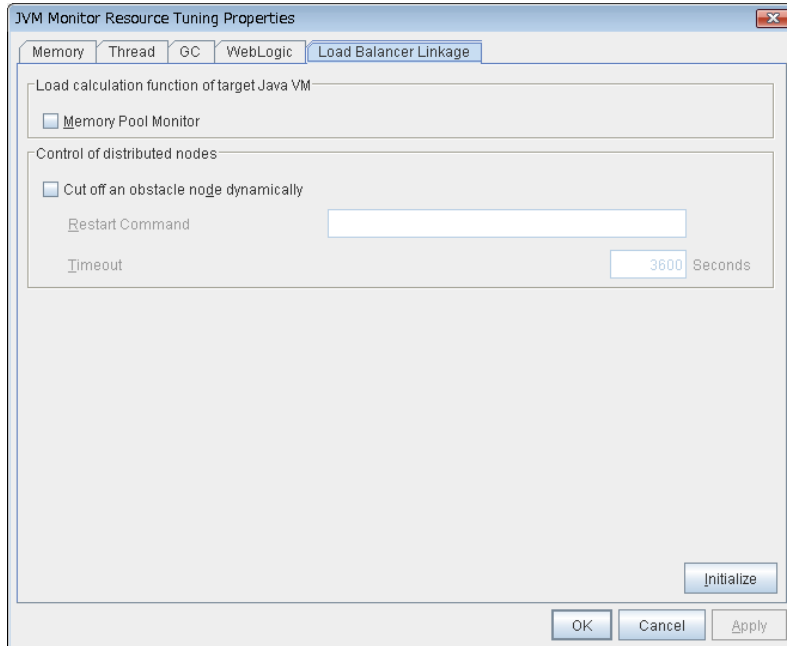

Properties - Monitor(special) tab -> Tuning property - Load Balancer Linkage tab
 Select the **Memory Pool Monitor** check box.

- **Custom monitor resource**

Properties - Monitor(common) tab
 Select the **Monitor Timing - Always** radio button.

Properties - Monitor(special) tab
 Select **Script created by this product(W)**. Select **File - Edit** and then add the following boldfaced section.

```
rem *****
rem *                genw.bat                *
rem *****
echo START
"<Installation path of
EXPRESSCLUSTER>\ha\jra\bin\clpjra_bigip.exe" weight
echo EXIT
```

Select the **Monitor Type - Synchronous** radio button.

In the BIG-IP LTM setting, specify **Ratio(node)** in **LocalTraffic - Pools:PoolList - Relevant pool - Members - LoadBalancing - Load Balancing Method** of BIG-IP Configuration Utility

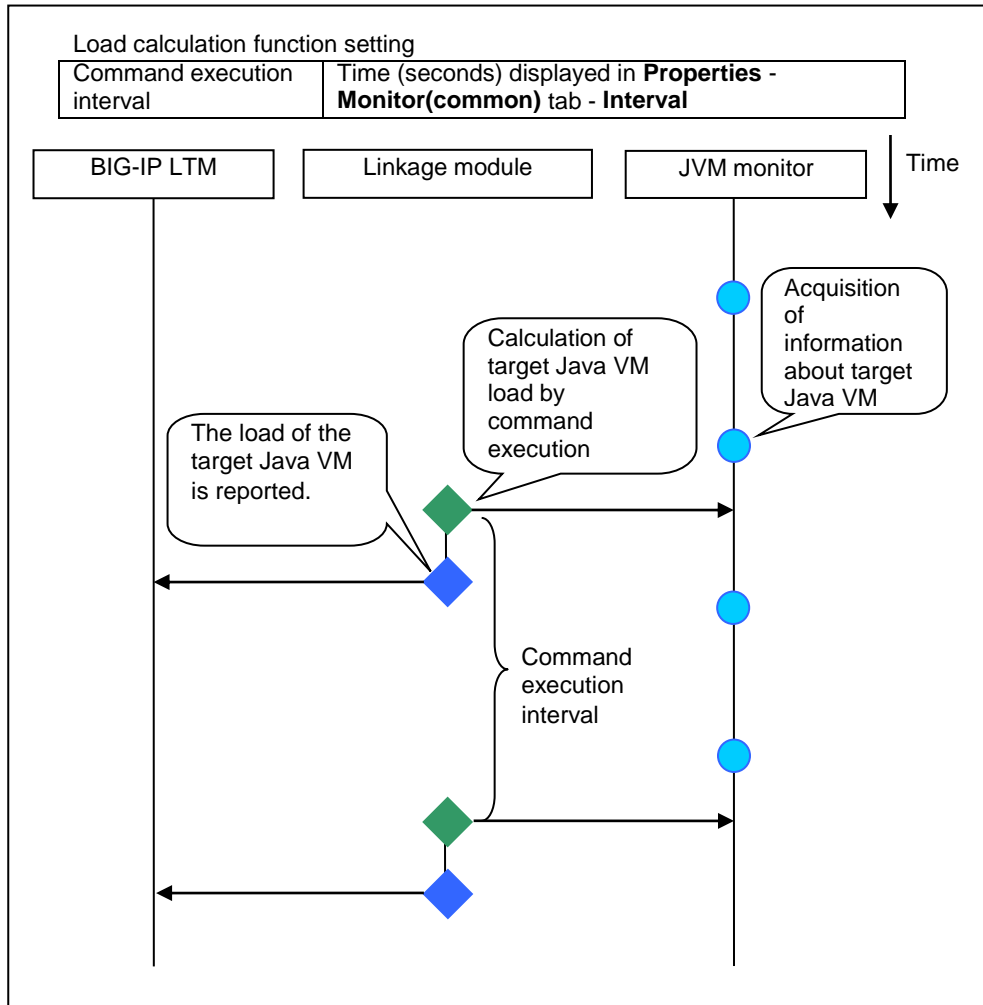

JVM statistical log

JVM monitor resources collect statistical information on the monitor target Java VM. The information is stored on CSV-format files, JVM statistical logs.

The following “monitor items” refer to parameters in the [Monitor(special)] tab in the [Properties] of the JVM monitor resources.

Statistical information is collected and output to its corresponding JVM statistical log when an item is selected and the threshold value is set for the item. If a monitor item is not selected, statistical information on the item will be neither collected nor output to its corresponding JVM statistical log.

The following table lists monitor items and their corresponding JVM statistical logs.

Monitor items	Corresponding JVM statistical log
[Memory] tab - [Monitor Heap Memory Rate] [Memory] tab - [Monitor Non-Heap Memory Rate]	jramemory.stat
[Thread] tab - [Monitor the number of Active Threads]	jraithread.stat
[GC] tab - [Monitor the time in Full GC] [GC] tab - [Monitor the count of Full GC execution]	jragc.stat
[Memory] tab - [Monitor Virtual Memory Usage]	jaruntime.stat
[WebLogic] tab - [Monitor the requests in Work Manager]	wlworkmanager.stat
[WebLogic] tab - [Monitor the requests in Thread Pool]	wlthreadpool.stat

Java memory area usage check on monitor target Java VM (jramemory.stat)

The jramemory.stat log file records the size of the Java memory area used by the monitor target Java VM. Its file name becomes either of the following two depending on the Rotation Type selected on the Log Output Setting dialog box.

- When Cluster Properties - [JVM monitor] tab - [Log Output Setting] - [Rotation Type] - [File Capacity] is checked: jramemory<integer starting with 0>.stat
- When Cluster Properties - [JVM monitor] tab - [Log Output Setting] - [Rotation Type] - [Period] is checked: jramemory<YYYYMMDDhhmm>.stat

Its data formats are as follows.

No	Format	Description
1	yyyy/mm/dd hh:mm:ss.SSS	Date and time of log recording
2	Half-size alphanumeric characters and symbols	Name of the monitor target Java VM; it has been specified in [Properties] - [Monitor(special)] tab - [Identification name] in JVM monitor resources.
3	Half-size alphanumeric characters and symbols	Name of the Java memory pool; for details, refer to “Java memory pool name.”
4	Half-size alphanumeric characters and symbols	Type of the Java memory pool Heap, Non-Heap
5	Half-size numeric characters	Memory size that the Java VM requests from the OS at startup; it is expressed in bytes. (init) At the startup of the monitor target Java VM, the size can be specified by the following Java VM startup options. <ul style="list-style-type: none"> • HEAP:-Xms • NON_HEAP permanent area (Perm Gen): -XX:PermSize • NON_HEAP code cache area (Code Cache): -XX:InitialCodeCacheSize

6	Half-size numeric characters	Memory size currently used by the Java VM; it is expressed in bytes. (used)
7	Half-size numeric characters	Memory size guaranteed for current use in operation of the Java VM; it is expressed in bytes. (committed) This size varies depending on memory use; it is always equal to the value of “used” or larger but equal to the value of “max” or smaller.
8	Half-size numeric characters	Maximum memory size that the Java VM can use; it is expressed in bytes. (max) The size can be specified by the following Java VM startup options. <ul style="list-style-type: none"> • HEAP:-Xmx • NON_HEAP permanent area (Perm Gen): -XX:MaxPermSize • NON_HEAP code cache area (Code Cache): -XX:ReservedCodeCacheSize <p>Example)</p> <pre>java -XX:MaxPermSize=128m -XX:ReservedCodeCacheSize=128m javaAP</pre> <p>In this example, max of NON_HEAP becomes 128 m + 128 m = 256 m.</p> <p>(Note)</p> <p>When the same value is specified for -Xms and -Xmx, “ini” may become larger than “max”. This is because “max” of HEAP is determined by subtracting half the size of Survivor Space from the area size ensured by specification of -Xmx.</p>
9	Half-size numeric characters	Peak size of the memory used after startup of the measurement target Java VM; when the name of the Java memory pool is HEAP or NON_HEAP, this size becomes equal to that of the memory currently used by the Java VM (used). It is expressed in bytes.
10	Half-size numeric characters	Memory size equal to “max” (No. 8 field) × the threshold (%) when the Java memory pool type (No. 4 field) is HEAP; it is expressed in bytes. When the Java memory pool type is not HEAP, it is 0.

Thread operation status check on monitor target Java VM (jrathread.stat)

The jrathread.stat log file records the thread operation status of the monitor target Java VM. Its file name becomes either of the following two depending on the Rotation Type selected on the Log Output Setting dialog box.

- When Cluster Properties - [JVM monitor] tab - [Log Output Setting] - [Rotation Type] - [File Capacity] is checked: jrathread<integer starting with 0>.stat
- When Cluster Properties - [JVM monitor] tab - [Log Output Setting] - [Rotation Type] - [Period] is checked: jrathread<YYYYMMDDhhmm>.stat

Its data formats are as follows.

No	Format	Description
1	yyyy/mm/dd hh:mm:ss.SSS	Date and time of log recording
2	Half-size alphanumeric characters and symbols	Name of the monitor target Java VM; it has been specified in [Properties] - [Monitor(special)] tab - [Identification name] in JVM monitor resources.

3	Half-size alphanumeric characters and symbols	The number of active threads in the monitor target Java VM
4	[Half-size numeric characters: half-size numeric characters:...]	Deadlocked thread ID in the monitor target Java VM; it contains the IDs of all deadlocked threads successively.
5	Half-size alphanumeric characters and symbols	Detailed information on deadlocked threads in the monitor target Java VM; it contains information on all deadlocked threads successively in the following format. ThreadName, ThreadID, ThreadStatus, UserTime, CpuTime, WaitedCount, WaitedTime, isInNative, isSuspended <line feed> stacktrace<line feed> : stacktrace<line feed> stacktrace=ClassName, FileName, LineNumber, MethodName, isNativeMethod

GC operation status check on monitor target Java VM (jragc.stat)

The jragc.stat log file records the GC operation status of the monitor target Java VM. Its file name becomes either of the following two depending on the Rotation Type selected on the Log Output Setting dialog box.

- When Cluster Properties - [JVM monitor] tab - [Log Output Setting] - [Rotation Type]-[File Capacity] is checked: jragc< integer starting with 0>.stat
- When Cluster Properties - [JVM monitor] tab - [Log Output Setting] - [Rotation Type] - [Period] is checked: jragc<YYYYMMDDhhmm>.stat

JVM monitor resources output two types of GC information: Copy GC and Full GC.

On Oracle Java, JVM monitor resources count the increment in the count of execution of the following GC as Full GC.

- MarkSweepCompact
- MarkSweepCompact
- PS MarkSweep
- ConcurrentMarkSweep

Its data formats are as follows.

No	Format	Description
1	yyyy/mm/dd hh:mm:ss.SSS	Date and time of log recording
2	Half-size alphanumeric characters and symbols	Name of the monitor target Java VM; it has been specified in [Properties] - [Monitor(special)] tab - [Identification name] in JVM monitor resources.
3	Half-size alphanumeric characters and symbols	GC name of the monitor target Java VM When the monitor target Java VM is Oracle Java The GC name to be indicated is one of the following. Copy MarkSweepCompact MarkSweepCompact PS Scavenge PS MarkSweep ParNew ConcurrentMarkSweep
4	Half-size numeric characters	Count of GC execution during the period from startup of the monitor target Java VM to measurement; the count includes GC executed before the JVM monitor resources starts monitoring.

5	Half-size numeric characters	Total time in GC during the period from startup of the monitor target Java VM to measurement; it is expressed in milliseconds. It includes time taken for GC executed before the JVM monitor resources starts monitoring.
---	------------------------------	---

Virtual memory usage check on monitor target Java VM (jraruntime.stat)

The jraruntime.stat log file records the size of the virtual memory used by the monitor target Java VM. Its file name becomes either of the following two depending on the Rotation Type selected on the Log Output Setting dialog box.

- When Cluster Properties - [JVM monitor] tab - [Log Output Setting] - [Rotation Type] - [File Capacity] is checked: jraruntime<integer starting with 0>.stat
- When Cluster Properties - [JVM monitor] tab - [Log Output Setting] - [Rotation Type] - [Period] is checked: jraruntime<YYYYMMDDhhmm>.stat

Its data formats are as follows.

No	Format	Description
1	yyyy/mm/dd hh:mm:ss.SSS	Date and time of log recording
2	Half-size alphanumeric characters and symbols	Name of the monitor target Java VM; it has been specified in [Properties] - [Monitor(special)] tab - [Identification name] in JVM monitor resources.
3	Half-size numeric characters	Start time of the monitor target Java VM expressed in milliseconds
4	Half-size numeric characters	Operating time of the monitor target Java VM expressed in milliseconds
5	Half-size alphanumeric characters and symbols	Size of the virtual memory used by the monitor target Java VM; it also includes the size of memory used in the heap area, non-heap area, and stack area. [Process name:PID,size of memory used:] It is expressed in bytes.

Operation status check on Work Manager of WebLogic Server (wlworkmanager.stat)

The wlworkmanager.stat log file records the operation status of the Work Manager of the WebLogic Server. Its file name becomes either of the following two depending on the Rotation Type selected on the Log Output Setting dialog box.

- When Cluster Properties - [JVM monitor] tab - [Log Output Setting] - [Rotation Type] - [File Capacity] is checked: wlworkmanager<integer starting with 0>.stat
- When Cluster Properties - [JVM monitor] tab - [Log Output Setting] - [Rotation Type] - [Period] is checked: wlworkmanager<YYYYMMDDhhmm>.stat

Its data formats are as follows.

No	Format	Description
1	yyyy/mm/dd hh:mm:ss.SSS	Date and time of log recording
2	Half-size alphanumeric characters and symbols	Name of the monitor target Java VM; it has been specified in [Properties] - [Monitor(special)] tab - [Identification name] in JVM monitor resources.
3	Half-size alphanumeric characters and symbols	Application name
4	Half-size alphanumeric characters and symbols	Work Manager name
5	Half-size numeric characters	Count of request execution
6	Half-size numeric characters	The number of wait requests

Operation status check on Thread Pool of WebLogic Server (wlthreadpool.stat)

The wlthreadpool.stat log file records the operation status of the thread pool of the WebLogic Server. Its file name becomes either of the following two depending on the Rotation Type selected on the Log Output Setting dialog box.

- When Cluster Properties - [JVM monitor] tab - [Log Output Setting] - [Rotation Type] - [File Capacity] is checked: wlthreadpool< *integer starting with 0* >.stat
- When Cluster Properties - [JVM monitor] tab - [Log Output Setting] - [Rotation Type] - [Period] is checked: wlthreadpool< *YYYYMMDDhhmm* >.stat

Its data formats are as follows.

No	Format	Description
1	yyyy/mm/dd hh:mm:ss.SSS	Date and time of log recording
2	Half-size alphanumeric characters and symbols	Name of the monitor target Java VM; it has been specified in [Properties] - [Monitor(special)] tab - [Identification name] in JVM monitor resources.
3	Half-size numeric characters	Total count of request execution
4	Half-size numeric characters	The number of requests queued in the WebLogic Server
5	Half-size numeric characters	Count of request execution per unit time (second)
6	Half-size numeric characters	The total number of threads for executing the application
7	Half-size numeric characters	The number of threads in an idle state
8	Half-size numeric characters	The number of executing threads
9	Half-size numeric characters	The number of threads in a stand-by state

Java memory pool name

This section describes the Java memory pool name outputted as memory_name in messages to the JVM operation log file. It also describes the Java memory pool name outputted to a JVM statistical log file, jramemory.stat log file.

The character strings of Java memory pool names are not determined by JVM monitor resources. Character strings received from the monitor target Java VM are output as Java memory pool names.

Their specifications are not open for Java VM, and accordingly, are subject to change without notice in a version upgrade of Java VM.

Therefore, we do not recommend monitoring Java memory pool names contained in messages.

The following monitor items refer to parameters in the [Memory] tab of the [Monitor(special)] tab in the [Properties] of the JVM monitor resources.

The following memory pool names have been confirmed on actual machines operating on Oracle Java.

When “-XX:+UseSerialGC” is specified as a startup option of the monitor target Java VM, the No. 3 Java memory pool name in the jramemory.stat log file appears as follows.

Monitor item	Character string outputted as memory_name
[Monitor Heap Memory Rate] - [Total Usage]	HEAP
[Monitor Heap Memory Rate] - [Eden Space]	Eden Space
[Monitor Heap Memory Rate] - [Survivor Space]	Survivor Space
[Monitor Heap Memory Rate] - [Tenured Gen]	Tenured Gen

[Monitor Non-Heap Memory Rate] - [Total Usage]	NON_HEAP
[Monitor Non-Heap Memory Rate] - [Code Cache]	Code Cache
[Monitor Non-Heap Memory Rate] - [Perm Gen]	Perm Gen
[Monitor Non-Heap Memory Rate] - [Perm Gen[shared-ro]]	Perm Gen [shared-ro]
[Monitor Non-Heap Memory Rate] - [Perm Gen[shared-rw]]	Perm Gen [shared-rw]

When “-XX:+UseParallelGC” and “-XX:+UseParallelOldGC” are specified as startup options of the monitor target Java VM, the No. 3 Java memory pool name in the jramemory.stat log file appears as follows.

Monitor item	Character string outputted as memory_name
[Monitor Heap Memory Rate] - [Total Usage]	HEAP
[Monitor Heap Memory Rate] - [Eden Space]	PS Eden Space
[Monitor Heap Memory Rate] - [Survivor Space]	PS Survivor Space
[Monitor Heap Memory Rate] - [Tenured Gen]	PS Old Gen
[Monitor Non-Heap Memory Rate] - [Total Usage]	NON_HEAP
[Monitor Non-Heap Memory Rate] - [Code Cache]	Code Cache
[Monitor Non-Heap Memory Rate] - [Perm Gen]	PS Perm Gen
[Monitor Non-Heap Memory Rate] - [Perm Gen[shared-ro]]	Perm Gen [shared-ro]
[Monitor Non-Heap Memory Rate] - [Perm Gen[shared-rw]]	Perm Gen [shared-rw]

When “-XX:+UseConcMarkSweepGC” is specified as a startup option of the monitor target Java VM, the No. 3 Java memory pool name in the jramemory.stat log file appears as follows.

Monitor item	Character string outputted as memory_name
[Monitor Heap Memory Rate] - [Total Usage]	HEAP
[Monitor Heap Memory Rate] - [Eden Space]	Par Eden Space
[Monitor Heap Memory Rate] - [Survivor Space]	Par Survivor Space
[Monitor Heap Memory Rate] - [Tenured Gen]	CMS Old Gen
[Monitor Non-Heap Memory Rate] - [Total Usage]	NON_HEAP
[Monitor Non-Heap Memory Rate] - [Code Cache]	Code Cache
[Monitor Non-Heap Memory Rate] - [Perm Gen]	CMS Perm Gen
[Monitor Non-Heap Memory Rate] - [Perm Gen[shared-ro]]	Perm Gen [shared-ro]
[Monitor Non-Heap Memory Rate] - [Perm Gen[shared-rw]]	Perm Gen [shared-rw]

When [Oracle Java(usage monitoring)] is selected for [JVM Type] and "-XX:+UseSerialGC" is specified as a startup option for the monitor target Java VM, the No. 3 Java memory pool name in the jramemory.stat file will be as follows.

Monitor item	Character string output as memory_name
[Monitor Heap Memory Usage]-[Total Usage]	HEAP
[Monitor Heap Memory Usage]-[Eden Space]	Eden Space
[Monitor Heap Memory Usage]-[Survivor Space]	Survivor Space
[Monitor Heap Memory Usage]-[Tenured Gen]	Tenured Gen
[Monitor Non-Heap Memory Usage]-[Total Usage]	NON_HEAP
[Monitor Non-Heap Memory Usage]-[Code Cache]	Code Cache(For Java 9, no output)
[Monitor Non-Heap Memory Usage]-[Metaspace]	Metaspace

When [Oracle Java(usage monitoring)] is selected for [JVM Type] and "-XX:+UseParallelGC" and "-XX:+UseParallelOldGC" are specified as startup options for the monitor target Java VM, the No. 3 Java memory pool name in the jramemory.stat file will be as follows.

Monitor item	Character string output as memory_name
[Monitor Heap Memory Usage]-[Total Usage]	HEAP
[Monitor Heap Memory Usage]-[Eden Space]	PS Eden Space
[Monitor Heap Memory Usage]-[Survivor Space]	PS Survivor Space
[Monitor Heap Memory Usage]- [Tenured Gen]	PS Old Gen
[Monitor Non-Heap Memory Usage]-[Total Usage]	NON_HEAP
[Monitor Non-Heap Memory Usage]-[Code Cache]	Code Cache(For Java 9, no output)
[Monitor Non-Heap Memory Usage]-[Metaspace]	Metaspace

When [Oracle Java(usage monitoring)] is selected for [JVM Type] and "-XX:+UseConcMarkSweepGC" is specified as a startup option for the monitor target Java VM, the No. 3 Java memory pool name in the jramemory.stat file will be as follows.

Monitor item	Character string output as memory_name
[Monitor Heap Memory Usage]-[Total Usage]	HEAP
[Monitor Heap Memory Usage]-[Eden Space]	Par Eden Space
[Monitor Heap Memory Usage]-[Survivor Space]	Par Survivor Space
[Monitor Heap Memory Usage]-[Tenured Gen]	CMS Old Gen
[Monitor Non-Heap Memory Usage]-[Total Usage]	NON_HEAP
[Monitor Non-Heap Memory Usage]-[Code Cache]	Code Cache(For Java 9, no output)
[Monitor Non-Heap Memory Usage]-[Metaspace]	Metaspace

When [Oracle Java(usage monitoring)] is selected for [JVM Type] and "-XX:+UseParNewGC" is specified as a startup option for the monitor target Java VM, the No. 3 Java memory pool name in the jramemory.stat file will be as follows. For Java 9, if -XX:+UseParNewGC is specified, the monitor target Java VM does not start.

Monitor item	Character string output as memory_name
[Monitor Heap Memory Usage]-[Total Usage]	HEAP
[Monitor Heap Memory Usage]-[Eden Space]	Par Eden Space
[Monitor Heap Memory Usage]-[Survivor Space]	Par Survivor Space
[Monitor Non-Heap Memory Usage]-[Tenured Gen]	Tenured Gen
[Monitor Non-Heap Memory Usage]-[Total Usage]	NON_HEAP
[Monitor Non-Heap Memory Usage]-[Code Cache]	Code Cache
[Monitor Non-Heap Memory Usage]-[Metaspace]	Metaspace

When [Oracle Java(usage monitoring)] is selected for [JVM Type] and "-XX:+UseG1GC" is specified as a startup option for the monitor target Java VM the No. 3 Java memory pool name in the jramemory.stat file will be as follows.

Monitor item	Character string output as memory_name
[Monitor Heap Memory Usage]-[Total Usage]	HEAP
[Monitor Heap Memory Usage]-[Eden Space]	G1 Eden Space
[Monitor Heap Memory Usage]-[Survivor Space]	G1 Survivor Space
[Monitor Heap Memory Usage]-[Tenured Gen(Old Gen)]	G1 Old Gen
[Monitor Non-Heap Memory Usage]-[Total Usage]	NON_HEAP
[Monitor Non-Heap Memory Usage]-[Code Cache]	Code Cache(For Java 9, no output)
[Monitor Non-Heap Memory Usage]-[Metaspace]	Metaspace

Java memory pool names appearing in the jramemory.stat log file, a JVM statistical log file, correspond to the Java VM memory space as follows.

◆ For Oracle Java 6/Oracle Java 7

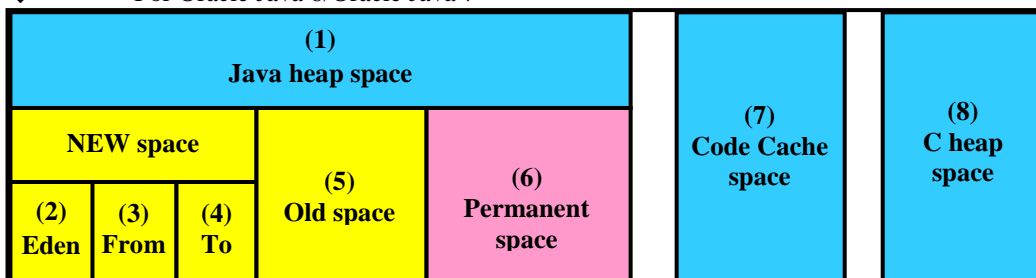

Number in diagram	Monitor item	Java memory pool name in jramemory.stat log file
(1)	[Monitor Heap Memory Rate] - [Total Usage]	HEAP
(2)	[Monitor Heap Memory Rate] - [Eden Space]	EdenSpace PS Eden Space Par Eden Space

(3)+(4)	[Monitor Heap Memory Rate] - [Survivor Space]	Survivor Space PS Survivor Space Par Survivor Space
(5)	[Monitor Heap Memory Rate] - [Tenured Gen]	Tenured Gen PS Old Gen CMS Old Gen
(6)	[Monitor Non-Heap Memory Rate] - [Perm Gen] [Monitor Non-Heap Memory Rate] - [Perm Gen[shared-ro]] [Monitor Non-Heap Memory Rate] - [Perm Gen[shared-rw]]	Perm Gen Perm Gen [shared-ro] Perm Gen [shared-rw] PS Perm Gen CMS Perm Gen
(7)	[Monitor Non-Heap Memory Rate] - [Code Cache]	Code Cache
(8)	-	-
(6)+(7)	[Monitor Non-Heap Memory Rate] - [Total Usage]	NON_HEAP * No stack trace is included.

◆ For Oracle Java 8/Oracle Java 9

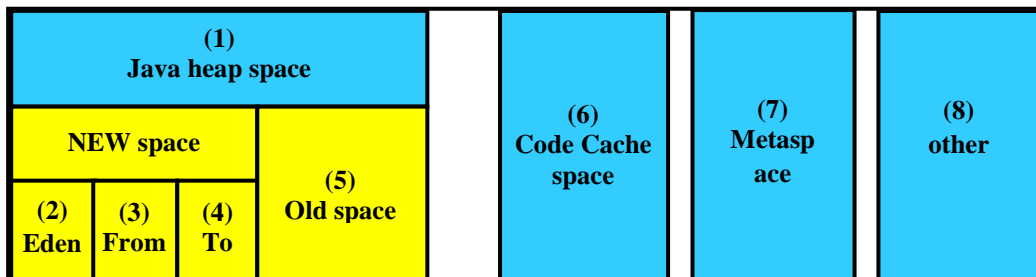

Number in diagram	Monitor item	Java memory pool name in jramemory.stat log file
(1)	[Monitor Heap Memory Usage] - [Total Usage]	HEAP
(2)	[Monitor Heap Memory Usage] - [Eden Space]	EdenSpace PS Eden Space Par Eden Space G1 Eden Space
(3)+(4)	[Monitor Heap Memory Usage] - [Survivor Space]	Survivor Space PS Survivor Space Par Survivor Space G1 Survivor Space
(5)	[Monitor Heap Memory Usage] - [Tenured Gen]	Tenured Gen PS Old Gen CMS Old Gen G1 Old Gen
(6)	[Monitor Non-Heap Memory Usage] - [Code Cache]	Code Cache
(7)	[Monitor Non-Heap Memory Usage] - [Metasp ace]	Metasp ace
(8)	-	Compressed Class Space, etc.
(6)+(7) +(8)	[Monitor Non-Heap Memory Usage] - [Total Usage]	NON_HEAP

Executing command corresponding to cause of each detected error

EXPRESSCLUSTER does not provide means for executing specific commands according to the causes of detected monitor resource errors.

JVM monitor resources can execute specific commands according to error causes. If an error is detected, JVM monitor resources will execute an appropriate command.

The following setting items specify commands that will be executed according to error causes.

Error cause	Setting item
<ul style="list-style-type: none"> • Failure in connection to the monitor target Java VM • Failure in resource measurement 	[Monitor(special)] tab - [Command]
<ul style="list-style-type: none"> • Heap memory rate • Non-heap memory rate • Virtual memory usage • Heap memory usage • Non-heap memory usage 	[Monitor(special)] tab - [Tuning] properties - [Memory] tab - [Command]
<ul style="list-style-type: none"> • The number of active threads 	[Monitor(special)] tab - [Tuning] properties - [Thread] tab - [Command]
<ul style="list-style-type: none"> • Time in Full GC • Count of Full GC execution 	[Monitor(special)] tab - [Tuning] properties - [GC] tab - [Command]
<ul style="list-style-type: none"> • Requests in Work Manager of WebLogic • Requests in Thread Pool of WebLogic 	[Monitor(special)] tab - [Tuning] properties - [WebLogic] tab - [Command]

A [Command] passes the detail of an error cause as the arguments of a command with the arguments attached to the end of the [Command]. A Command further specialized for dealing with specific error causes can be defined by designing and specifying a script etc. for a [Command]. The following character strings are passed as the arguments.

When multiple character strings are stated as possible arguments, one of them will be passed according to the CG type of the monitor target Java VM. For the details of their differences, refer to “Java memory pool name”.

Statements “(For Oracle Java)” suggest that different character strings are used according to the JVM type. When no such statement is contained, the same character strings will be equally used for all JVM types.

Details of error causes	Character string for argument
<ul style="list-style-type: none"> • Failure in connection to the monitor target Java VM • Failure in resource measurement 	No character string defined
[Monitor(special)] tab - [Tuning] properties - [Memory] tab - [Monitor Memory Heap Rate] - [Total Usage] (For Oracle Java)	HEAP
[Memory] tab - [Monitor Memory Heap Rate] - [Eden Space] (For Oracle Java)	EdenSpace PSEdenSpace ParEdenSpace
[Memory] tab - [Monitor Memory Heap Rate] - [Survivor Space] (For Oracle Java)	SurvivorSpace PSSurvivorSpace ParSurvivorSpace
[Memory] tab - [Monitor Memory Heap Rate] - [Tenured Gen] (For Oracle Java)	TenuredGen PSOldGen CMSOldGen

[Memory] tab - [Monitor Non-Heap Memory Rate] - [Total Usage] (For Oracle Java)	NON_HEAP
[Memory] tab - [Monitor Memory Non-Heap Rate] - [Code Cache] (For Oracle Java)	CodeCache
[Memory] tab - [Monitor Memory Non-Heap Rate] - [Perm Gen] (For Oracle Java)	PermGen PSPermGen CMSPermGen
[Memory] tab - [Monitor Memory Non-Heap Rate] - [Perm Gen[shared-ro]] (For Oracle Java)	PermGen[shared-ro]
[Memory] tab - [Monitor Memory Non-Heap Rate] - [Perm Gen[shared-rw]] (For Oracle Java)	PermGen[shared-rw]
[Memory] tab - [Monitor Virtual Memory Usage] - (For Oracle Java)	Vmsize
[Memory] tab - [Monitor Heap Memory Usage] - [Total Usage] (for Oracle Java(usage monitoring))	HEAP
[Memory] tab - [Monitor Heap Memory Usage] - [Eden Space] (for Oracle Java(usage monitoring))	EdenSpace PSEdenSpace ParEdenSpace G1EdenSpace
[Memory] tab - [Monitor Heap Memory Usage]-[Survivor Space] (for Oracle Java(usage monitoring))	SurvivorSpace PSSurvivorSpace ParSurvivorSpace G1SurvivorSpace
[Memory] tab - [Monitor Heap Memory Usage] - [Tenured Gen] (for Oracle Java(usage monitoring))	TenuredGen PSOldGen CMSOldGen G1OldGen
[Memory] tab - [Monitor Non-Heap Memory Usage] - [Total Usage] (for Oracle Java(usage monitoring))	NON_HEAP
[Memory] tab - [Monitor Non-Heap Memory Usage] - [Code Cache] (for Oracle Java(usage monitoring))	CodeCache
[Memory] tab - [Monitor Non-Heap Memory Usage] - [Metaspace] (for Oracle Java(usage monitoring))	Metaspace
[Thread] tab - [Monitor the number of Active Threads]	Count
[GC] tab - [Monitor the time in Full GC]	Time
[GC] tab - [Monitor the count of Full GC execution]	Count
[WebLogic] tab - [Monitor the requests in Work Manager] - [Waiting Requests, The number]	WorkManager_PendingRequests
[WebLogic] tab - [Monitor the requests in Thread Pool] - [Waiting Requests, The number]	ThreadPool_PendingUserRequestCount
[WebLogic] tab - [Monitor the requests in Thread Pool] - [Executing Requests, The number]	ThreadPool_Throughput

The following are examples of execution.

Example 1)

Setting item	Setting information
[Monitor(special)] tab - [Tuning] properties - [GC] tab - [Command]	c:\Program Files\bin\downcmd
[Monitor(special)] tab - [Tuning] properties - [GC] tab - [Monitor the count of Full GC execution]	1
[Cluster] properties - [JVM monitor] tab - [Resource Measurement Setting] - [Common] tab - [Error Threshold]	3

If Full GC is executed successively as many times as specified by the Error Threshold (three times), JVM monitor resources will detect a monitor error and execute a command corresponding to “c:\Program Files\bin\downcmd Cont”.

Example 2)

Setting item	Setting information
[Monitor(special)] tab - [Tuning] properties - [GC] tab - [Command]	“c:\Program Files\bin\downcmd” GC
[Monitor(special)] tab - [Tuning] properties - [GC] tab - [Monitor the time in Full GC]	65536
[Cluster] properties - [JVM monitor] tab - [Resource Measurement Setting] - [Common] tab - [Error Threshold]	3

If the time in Full GC exceeds 65535 milliseconds successively as many times as specified by the Error Threshold (three times), JVM monitor resources will detect a monitor error and execute a command corresponding to “c:\Program Files\bin\downcmd GC Time”.

Example 3)

Setting item	Setting information
[Monitor(special)] tab - [Tuning] properties - [Memory] tab - [Command]	“c:\Program Files\bin\downcmd” memory
[Monitor(special)] tab - [Tuning] properties - [Memory] tab - [Monitor Heap Memory Rate]	On
[Monitor(special)] tab - [Tuning] properties - [Memory] tab - [Eden Space]	80
[Monitor(special)] tab - [Tuning] properties - [Memory] tab - [Survivor Space]	80
[Cluster] properties - [JVM monitor] tab - [Resource Measurement Setting] - [Common] tab - [Error Threshold]	3

If the usage rate of the Java Eden Space and that of the Java Survivor Space exceed 80% successively as many times as specified by the Error Threshold (three times), JVM monitor resources will detect a monitor error and execute a command corresponding to “c:\Program Files\bin\downcmd memory EdenSpace SurvivorSpace”.

Timeout (second) for waiting for the completion of execution of the command specified by the [Command] is set by specifying the [Command Timeout] in the [JVM monitor] of the Cluster Properties window. The same value is applied to the timeout of the [Command] of each of the above-mentioned tabs; the timeout cannot be specified for each [Command] separately.

If a timeout occurs, the system will not perform processing for forced termination of the [Command] process; the operator needs to perform post-processing (e.g. forced termination) of the [Command] process. When a timeout occurs, the following message is output to the JVM operation log:

action thread execution did not finish. action is alive = <command>

Note the following cautions.

- No [Command] is executed when restoration of the Java VM to normal operation (error → normal operation) is detected.
- A [Command] is executed upon detection of an error of the Java VM (when threshold crossing occurs successively as many times as specified by the error threshold). It is not executed at each threshold crossing.
- Note that specifying a [Command] on multiple tabs allows multiple commands to be executed if multiple errors occur simultaneously, causing a large system load.

- A [Command] may be executed twice simultaneously when the following two items are monitored: [Monitor(special)] tab - [Tuning] properties - [WebLogic] tab - [Monitor the requests in Work Manager] - [Waiting Requests, The Number]; [Monitor(special)] tab - [Tuning] properties - [WebLogic] tab - [Monitor the requests in Work Manager] - [Waiting Requests, Average].

This is because errors may be detected simultaneously on the following two items: [Cluster] properties - [JVM monitor] tab - [Resource Measurement Setting] - [WebLogic] tab - [Interval, The number of request]; [Cluster] properties - [JVM monitor] tab - [Resource Measurement Setting] - [WebLogic] tab - [Interval, The average number of the request]. To avoid this phenomenon, specify only one of the two items as a monitor target. This applies to the following combinations of monitor items.

- [Monitor(special)] tab - [Tuning] properties - [WebLogic] tab - [Monitor the requests in Thread Pool] - [Waiting Requests, The Number] and [Monitor(special)] tab - [Tuning] properties - [WebLogic] tab - [Monitor the requests in Thread Pool] - [Waiting Requests, Average]
- [Monitor(special)] tab - [Tuning] properties - [WebLogic] tab - [Monitor the requests in Thread Pool] - [Executing Requests, The Number] and [Monitor(special)] tab - [Tuning] properties - [WebLogic] tab - [Monitor the requests in Thread Pool] - [Executing Requests, Average]

Monitoring WebLogic Server

For how to start the operation of the configured target WebLogic Server as an application server, see the manual for WebLogic Server.

This section describes only the settings required for monitoring by the JVM monitor resource.

1. Start WebLogic Server Administration Console.

For how to start WebLogic Server Administration Console, refer to “Overview of Administration Console” in the WebLogic Server manual.

Select **Domain Configuration-Domain-Configuration-General**. Make sure that **Enable Management Port** is unchecked.

2. Select **Domain Configuration-Server**, and then select the name of the server to be monitored. Set the selected server name as the identifier on the **Monitor(special)** tab from **Properties** that can be selected in the Builder tree view.
3. Regarding the target server, select **Configuration-General**, and then check the port number through which a management connection is established with **Listen Port**.
4. Stop WebLogic Server. For how to stop WebLogic Server, refer to “Starting and stopping WebLogic Server” in the WebLogic Server manual.
5. Open the script for starting the WebLogic Server managing server (`startWebLogic.cmd`).
6. Write the following instructions in the script.

➤ When the target is the WebLogic Server managing server:

```
✓ set JAVA_OPTIONS=%JAVA_OPTIONS%
-Dcom.sun.management.jmxremote.port=n
-Dcom.sun.management.jmxremote.ssl=false
-Dcom.sun.management.jmxremote.authenticate=false
```

*Write each line of coding on one line.

Note:

For **n**, specify the number of the port used for monitoring. The specified port number **must be different from that of the listen port for the target Java VM**. If there are other target WebLogic Server entities on the same machine, specify a port number different from those for the listening port and application ports of the other entities.

➤ When the target is a WebLogic Server managed server:

```
✓ if "%SERVER_NAME%" == "SERVER_NAME" (
  set JAVA_OPTIONS=%JAVA_OPTIONS%
  -Dcom.sun.management.jmxremote.port=n
  -Dcom.sun.management.jmxremote.ssl=false
  -Dcom.sun.management.jmxremote.authenticate=false
)
```

*Write all the if statement lines (lines 2 to 5) on one line.

Note:

For **SERVER_NAME**, specify the name of the target server confirmed by **Select Target Server**. If more than one server is targeted, change the server name on the settings (line 1 to 6) for each server.

Note:

When the target is WebLogic Server 11gR1(10.3.3) or later, add the following options:

```
-Djavax.management.builder.initial=weblogic.management.jmx.
mbeanserver.WLSMBeanServerBuilder
```

Note:

Place the above addition prior to the following coding:

```
%JAVA_HOME%\bin\java %JAVA_VM% %MEM_ARGS%
-Dweblogic.Name=%SERVER_NAME%
-Djava.security.policy=%WL_HOME%\server\lib\weblogic.policy %JAVA_OPTIONS
% %PROXY_SETTINGS% %SERVER_CLASS%
```

*Write the above coding on one line.

* The contents of the above arguments may differ depending on the WebLogic version. In such a case, write JAVA_OPTIONS in the script before executing java.

7. Redirect the standard output and standard error output of the target WebLogic Server to a file. For how to configure these settings, refer to the WebLogic Server manual. Configure the settings if you want to include the standard output and standard error output in information to be collected. When configuring the settings, be careful to secure sufficient hard disk space.
8. Configure the settings so as to output the GC log to the target WebLogic Server. For how to configure these settings, refer to the WebLogic Server manual. Configure the settings if you want to include the GC log in information to be collected. When configuring the settings, be careful to secure sufficient hard disk space.
9. Start WLST (wlst.cmd) of the target WebLogic Server. To do this, select **Start menu-Oracle WebLogic-WebLogic Server <version number>-Tools-WebLogic Scripting Tool**.

10. On the prompt window displayed, execute the following commands. Replace the **USERNAME**, **PASSWORD**, **SERVER_ADDRESS**, **SERVER_PORT**, and **DOMAIN_NAME** with those for the domain environment.

```
>connect(' USERNAME' , ' PASSWORD' , ' t3://SERVER_ADDRESS:SERVER_PORT' )
> edit()
> startEdit()
> cd(' JMX/DOMAIN_NAME' )
> set(' PlatformMBeanServerUsed' , ' true' )
> activate()
> exit()
```

11. Restart the target WebLogic Server.

Monitoring WebOTX

This section describes how to configure a target WebOTX to enable monitoring by the JVM monitor resource.

Start the WebOTX Administration Console. For how to start the WebOTX Administration Console, refer to “Starting the console” in the *WebOTX Operation (Web Administration Console)*.

The settings differ depending on whether a Java process of the JMX agent running on WebOTX or the Java process of a process group is to be monitored. Configure the settings according to the target of monitoring.

Monitoring a Java process of the WebOTX domain agent

There is no need to specify any settings. If you are using V8.30, please upgrade to V8.31 or later.

Monitoring a Java process of a WebOTX process group

1. Connect to the domain by using the administration console.
2. In the tree view, select **<domain_name>-TP System-Application Group-<application_group_name>-Process Group-<process_group_name>**.
3. For the **Other Arguments** attributes on the **JVM Options** tab on the right, specify the following Java options on one line. For *n*, specify the port number. If there is more than one Java VM to be monitored on the same machine, specify a unique port number. The port number specified for the settings is specified with Builder (table view → **JVM Monitor Resource Name** → **Property** → **Monitor(special)** tab → **Connection Port**).

```
-Dcom.sun.management.jmxremote.port=n
-Dcom.sun.management.jmxremote.ssl=false
-Dcom.sun.management.jmxremote.authenticate=false
-Djavax.management.builder.initial=com.nec.webotx.jmx.mbeanserver.JmxMBeanServerBuilder
```

* In the case of WebOTX V9.2 or later, it is unnecessary to specify -Djavax.management.builder.initial.

4. Then, click **Update**. After the configuration is completed, restart the process group.

These settings can be made by using **Java System Properties**, accessible from the **Java System Properties** tab of the WebOTX administration console. When making these settings by using the console, do not designate “-D” and set the strings prior to “=” in “name” and set the strings subsequent to “=” in “value”.

Note: If restart upon a process failure is configured as a function of the WebOTX process group, and when the process group is restarted as the recovery processing by EXPRESSCLUSTER, the WebOTX process group may fail to function correctly. For this reason, when monitoring the WebOTX process group, make the following settings for the JVM monitor resource by using the Builder.

Tab name for setting	Item name	Setting value
Monitor(common)	Monitor Timing	Always
Recovery Action	Recovery Action	Execute only the final action
Recovery Action	Final Action	No operation

Linking with the load balancer is not supported for WebOTX process group monitoring.

Receiving WebOTX notifications

By registering a specific listener class, notification is issued when WebOTX detects a failure. The JVM monitor resource receives the notification and outputs the following message to the JVM operation log.

```
%1$s:Notification received. %2$s.
```

%1\$s and %2\$s each indicates the following:

```
%1$s: Monitored Java VM
```

```
%2$s: Message in the notification (ObjectName=**,type=**,message=**)
```

At present, the following is the detailed information on MBean on the monitorable resource.

ObjectName	[domainname];j2eeType=J2EEDomain,name=[domainname],category=runtime
notification type	nec.webotx.monitor.alivecheck.not-alive
Message	failed

Monitoring Tomcat

This section describes how to configure a target Tomcat to be monitored by the JVM monitor resource.

1. Stop Tomcat, and then open **Start** → (*Tomcat_Program_folder*) → **Configure Tomcat**.
2. In the Java Options of Java of the open window, specify the following settings. For *n*, specify the port number. If there is more than one Java VM to be monitored on the same machine, specify a unique port number. The port number specified for the settings is specified with Builder (table view → **JVM Monitor Resource Name** → **Property** → **Monitor(special)** tab → **Connection Port**).

```
-Dcom.sun.management.jmxremote.port=n
-Dcom.sun.management.jmxremote.ssl=false
-Dcom.sun.management.jmxremote.authenticate=false
```
3. Save the settings, and then start Tomcat.

- With Builder (table view → **JVM Monitor Resource Name** → **Property** → **Monitor(special)** tab → **Identifier**), specify a unique string that is different from those for the other monitor targets (e.g., tomcat). With Builder (table view → **JVM Monitor Resource Name** → **Property** → **Monitor (special)** tab → **Process Name**), set “com.sun.management.jmxremote.port=*n*” (*n* is the port number specified in 2).

Monitoring SVF

This section describes how to configure a target SVF to be monitored by the JVM monitor resource.

- Select a monitor target from the following, and then use an editor to open the file.

Monitor target	File to be edited
Report Director EnterpriseServer	<SVF installation path> \\launcher\ReportDirectorEnterpriseServer.run
Report Director Svf Server	<SVF installation path> \\launcher\ReportDirectorSvfServer.run
Report Director Spool Balancer	<SVF installation path> \\launcher\ReportDirectorSpoolBalancer.run
Tomcat	The window indicated by carrying out the following <SVF installation path> \\apache-tomcat\bin\tomcat5w.exe //ES//SVFWebService
SVF Print Spooler services	<SVF installation path> \\svfjpd\launcher\SpoolerDaemon.run

- The following contents are inserted in the part where Arguments is designated just after the setting point of "-Xms". For *n*, specify the port number. If there is more than one Java VM to be monitored on the same machine, specify a unique port number. The port number specified here is also specified with the Builder (table view → **JVM Monitor Resource Name** → **Property** → **Monitor(special)** tab → **Connection Port**).

```
-Dcom.sun.management.jmxremote.port=n
-Dcom.sun.management.jmxremote.ssl=false
-Dcom.sun.management.jmxremote.authenticate=false
```

- With the Builder (table view → **JVM Monitor Resource Name** → **Property** → **Monitor(special)** tab → **Identifier**), and with the Builder (table view → **JVM Monitor Resource Name** → **Property** → **Monitor (special)** tab → **Process Name**), specify the following.

Monitor target	Identifier, Process Name
Report Director EnterpriseServer	RDEServer
Report Director Svf Server	RDSvfServer
Report Director Spool Balancer	ReportDirectorSpoolBalancer
Tomcat	Tomcat
SVF Print Spooler services	spooler.Daemon

Displaying and changing the JVM monitor resource details

1. Click the **Monitors** icon on the tree view displayed on the left side of the Builder window.
2. A list of the monitor resources is displayed in the table view on the right side of the screen. Right-click the target JVM monitor resource, and click the **Monitor(special)** tab in the **Monitor Resource Properties** window.
3. On the **Monitor(special)** tab, you can see and/or change the detailed settings as described below.

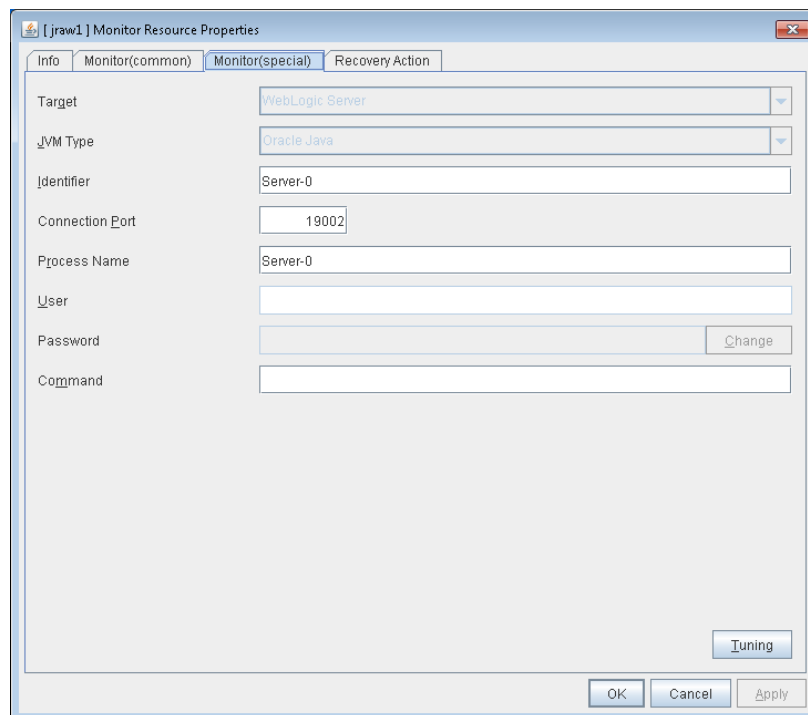

Target **SuspendResume**

Select the target to be monitored from the list. When monitoring WebSAM SVF for PDF, WebSAM Report Director Enterprise, or WebSAM Universal Connect/X, select **WebSAM SVF**. When monitoring a Java application that you created, select **Java Application**.

Default: None

JVM Type **SuspendResume**

Select the Java VM on which the target application to be monitored is running.

For Java 8 or later, select **Oracle Java(usage monitoring)**. For Java 8, the following specification changes have been made.

- It has become impossible to acquire the maximum value of each memory in a non-heap area.
- Perm Gen has been changed to Metaspace.

For Java 8, therefore, the monitor items on the **Memory** tab have been changed as below.

- Monitoring for the use rate has been changed to monitoring for the amount used.
- **Perm Gen**, **Perm Gen[shared-ro]**, and **Perm Gen[shared-rw]** cannot be monitored. Clear the check box.
- **Metaspace** can be monitored.

For Java 9, the following specification changes have been made.

- **Code Cache** has been divided.

For Java9, therefore, the monitor items on the **Memory** tab have been changed as below.

- **Code Cache** cannot be monitored. Clear the check box.

Default: None

Identifier (within 255 bytes) **SuspendResume**

The identifier is set to differentiate the relevant JVM monitor resource from another JVM monitor resource when the information on the application to be monitored is output to the JVM operation log of the relevant JVM monitor resource. For this purpose, set a unique character string between JVM monitor resources. You must specify the identifier.

- When the target is **WebLogic Server**
Set the name of the server instance to be monitored, according to “Monitoring WebLogic Server”, item 2.
- When the target is **WebOTX Process Group**
Specify the name of the process group.
- When the target is **WebOTX Domain Agent**
Specify the name of the domain.
- When the target is **WebOTX ESB**
Same as for **WebOTX Process Group**.
- When the target is **Tomcat**
Specify this according to “Monitoring Tomcat”.
- When the target is **WebSAM SVF**
Specify this according to “Monitoring SVF”.
- When the target is **Java applications**
Specify a uniquely identifiable string for the monitored Java VM process.

Default: None

Connection Port (1024 to 65535) **SuspendResume**

Set the port number used by the JVM monitor resource when it establishes a JMX connection to the target Java VM. The JVM monitor resource obtains information by establishing a JMX connection to the target Java VM. Therefore, to register the JVM monitor resource, it is necessary to specify the setting by which the JMX connection port is opened for the target Java VM. You must specify the connection port. This is common to all the servers in the cluster. A value between 42424 and 61000 is not recommended.

- When the target is **WebLogic Server**
Set the connection port number according to “Monitoring WebLogic Server”, item 6.
- When the target is **WebOTX Process Group**
Specify this according to “Monitoring a Java process of a WebOTX process group”.
- When the target is **WebOTX Domain Agent**
Specify “domain.admin.port” of
“(WebOTX_installation_path)\<domain_name>.properties”.
- When the target is **WebOTX ESB**
Same as for **WebOTX Process Group**.
- When the target is **Tomcat**
Specify as described in “Monitoring Tomcat”.

- When the target is **WebSAM SVF**
Specify this according to “Monitoring SVF”.
- When the target is **Java applications**
Specify a uniquely identifiable string for the monitored Java VM process.

Default: None

Process Name (within 255 bytes) **SuspendResume**

Set a **Process Name** to identify the target JVM monitor resource when outputting information of the monitor target to the JVM operation log of the JVM monitor resource. Therefore, be sure to specify a character string that is unique among JVM monitor resources.

- When the target is **WebLogic Server**
Specify a unique server instance name for a process name to identify the target Java VM process. If the process name consisting of only a server instance name is not unique, specify a process name by combining a server instance name and **Connection Port** number.
Example: When the server instance name is ServerA and the **Connection Port** number is 7001, the **Process Name** is ServerA7001.
- When the target is other than **WebOTX Process Group**
Specify the name of the process group. If you are specifying multiple settings, specify a string that can be uniquely identified across the group process so that no name is specified more than the same process group.
- When the target is **WebOTX Domain Agent**
Specify "-Dwebotx.funcid=agent -Ddomain.name=<domain_name>".
- When the target is **WebOTX ESB**
Same as for **WebOTX Process Group**.
- When the target is **Tomcat**
Specify this according to “Monitoring Tomcat”.
- When the target is **WebSAM SVF**
Specify this according to “Monitoring SVF”.
- When the target is **Java applications**
Specify a uniquely identifiable string for the monitored Java VM process.

Default: None

User (within 255 bytes) **SuspendResume**

Specify the name of the administrator who will be making a connection with the target Java VM. When **WebOTX Domain Agent** is selected as the target, specify the “domain.admin.user” value of “(WebOTX_installation_path)\<domain_name>.properties”.

Default: None

Password (within 255 bytes) **SuspendResume**

Specify the password for the administrator who will be making a connection with the target Java VM. When **WebOTX Domain Agent** is selected as the target, specify the “domain.admin.passwd” value of “(WebOTX_installation_path)\<domain_name>.properties”. Click **Change** and enter the password in the dialog box. The letters of the password are not displayed.

Default: None

Command (within 255 bytes) **SuspendResume**

Specify the command to execute if an error is detected in the target Java VM. It is possible to specify the command to execute for each error cause, as well as arguments. Specify a full path. Enclose an executable file name with double quotes (""). Example) "\\Program Files\bin\command.bat" arg1 arg2

Here, specify the commands to execute if it is impossible to connect to the target Java VM and if an error is detected in acquiring the resource amount used.

See also "Executing command corresponding to cause of each detected error".

Default: None

When you click **Tuning**, the following information is displayed in the pop-up dialog box. Make detailed settings according to the descriptions below.

Memory tab(when Oracle Java is selected for JVM Type)

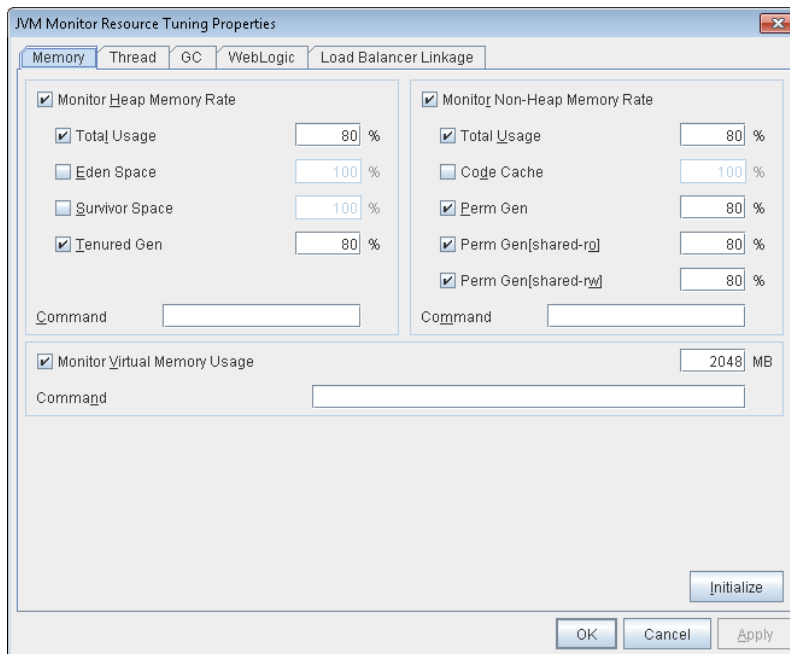

Monitor Heap Memory Rate **SuspendResume**

Enables the monitoring of the usage rates of the Java heap areas used by the target Java VM.

- When the checkbox is selected:
Monitoring enabled
- When the checkbox is not selected: (default):
Monitoring disabled

Total Usage (1 to 100) **SuspendResume**

Specify the threshold for the usage rate of the Java heap areas used by the target Java VM.

Default: 80[%]

Eden Space (1 to 100) `SuspendResume`

Specify the threshold for the usage rate of the Java Eden Space used by the target Java VM. If G1 GC is specified as the GC method of the target Java VM, read it as G1 Eden Space.

Default: 100[%]

Survivor Space (1 to 100) `SuspendResume`

Specify the threshold for the usage rate of the Java Survivor Space used by the target Java VM. If G1 GC is specified as the GC method of the target Java VM, read it as G1 Survivor Space.

Default: 100[%]

Tenured Gen (1 to 100) `SuspendResume`

Specify the threshold for the usage rate of the Java Tenured(Old) Gen area used by the target Java VM. If G1 GC is specified as the GC method of the target Java VM, read it as G1 Old Gen.

Default: 80[%]

Monitor Non-Heap Memory Rate `SuspendResume`

Enables the monitoring of the usage rates of the Java non-heap areas used by the target Java VM.

- When the checkbox is selected:
Monitoring enabled
- When the checkbox is not selected: (default):
Monitoring disabled

Total Usage (1 to 100) `SuspendResume`

Specify the threshold for the usage rate of the Java non-heap areas used by the target Java VM.

Default: 80[%]

Code Cache (1 to 100) `SuspendResume`

Specify the threshold for the usage rate of the Java Code Cache area used by the target Java VM.

Default: 100[%]

Perm Gen (1 to 100) `SuspendResume`

Specify the threshold for the usage rate of the Java Perm Gen area used by the target Java VM.

Default: 80[%]

Perm Gen[shared-ro] (1 to 100) `SuspendResume`

Specify the threshold for the usage rate of the Java Perm Gen [shared-ro] area used by the target Java VM.

The **Java Perm Gen [shared-ro]** area is used when `-client -Xshare:on -XX:+UseSerialGC` is specified as the startup option of the target Java VM.

Default: 80[%]

Perm Gen[shared-rw] (1 to 100) `SuspendResume`

Specify the threshold for the usage rate of the Java Perm Gen [shared-rw] area used by the target Java VM.

The **Java Perm Gen [shared-rw]** area is used when `-client -Xshare:on -XX:+UseSerialGC` is specified as the startup option of the target Java VM.

Default: 80[%]

Monitor Virtual Memory Usage (1 to 3072) Suspend/Resume

Specify the threshold for the usage of the virtual memory used by the target Java VM. JVM monitor resources do not support the monitoring of virtual memory usage when target Java VM consists of 64-bit processes. Therefore, when the target Java VM consists of 64-bit processes, uncheck this check box.

Default: 2048[MB]

Command (within 255 bytes) Suspend/Resume

Specify the command to execute if an error is detected in the target Java VM. It is possible to specify the command to execute for each error cause, as well as arguments. Specify a full path. Enclose an executable file name with double quotes (""). Example) "\Program Files\bin\command.bat" arg1 arg2

Here, specify the commands to execute if an error is detected in the Java heap area, Java non-heap area, and virtual memory usage amount of the target Java VM.

See also "Executing command corresponding to cause of each detected error".

Default: None

Initialize

Click the Initialize button to set all the items to their default values.

Memory tab(when Oracle Java(usage monitoring) is selected for JVM Type)

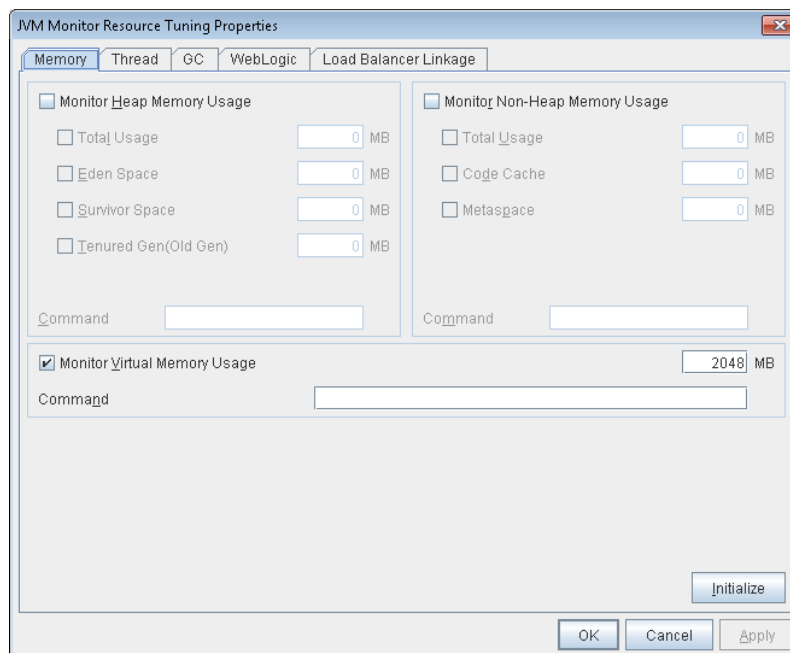

Monitor Heap Memory Usage Suspend/Resume

Enables the monitoring of the amount of the Java heap areas used by the target Java VM.

- When the checkbox is selected: Monitoring enabled
- When the checkbox is not selected: (default): Monitoring disabled

Total Usage (1 to 102400) **SuspendResume**

Specify the threshold for the usage rate of the Java heap areas used by the target Java VM. If zero is specified, this item is not monitored.

Default: 0[MB]

Eden Space(1 to 102400) **SuspendResume**

Specify the threshold for the usage rate of the Java Eden Space used by the target Java VM. If zero is specified, this item is not monitored. If G1 GC is specified as the GC method of the target Java VM, read it as G1 Eden Space.

Default: 0[MB]

Survivor Space(1 to 102400) **SuspendResume**

Specify the threshold for the usage rate of the Java Survivor Space used by the target Java VM. If zero is specified, this item is not monitored. If G1 GC is specified as the GC method of the target Java VM, read it as G1 Survivor Space.

Default: 0[MB]

Tenured Gen(1 to 102400) **SuspendResume**

Specify the threshold for the usage rate of the Java Tenured(Old) Gen area used by the target Java VM. If zero is specified, this item is not monitored. If G1 GC is specified as the GC method of the target Java VM, read it as G1 Old Gen.

Default: 0[MB]

Monitor Non-Heap Memory Usage **SuspendResume**

Enables the monitoring of the usage rate of the Java non-heap areas used by the target Java VM.

- When the check box is selected:
Monitoring is enabled.
- When the check box is not selected (default):
Monitoring is disabled.

Total Usage(1 to 102400) **SuspendResume**

Specify the threshold for the usage rate of the Java **non-heap areas** used by the target Java VM. If zero is specified, this item is not monitored.

Default: 0[MB]

Code Cache(1 to 102400) **SuspendResume**

Specify the threshold for the usage rate of the Java **Java Code Cache** used by the target Java VM. If zero is specified, this item is not monitored.

Default: 0[MB]

Perm Gen(1 to 102400) **SuspendResume**

Specify the threshold for the usage rate of the Java **Java Perm Gen** used by the target Java VM. If zero is specified, this item is not monitored.

Default: 0[MB]

Metaspace(1 to 102400) **SuspendResume**

Specify the threshold for the usage rate of the Metaspace area used by the target Java VM.

Default: 0[MB]

Monitor Virtual Memory Usage (1 to 3072) **SuspendResume**

Specify the threshold for the usage rate of the virtual memory used by the target Java VM. JVM monitor resources do not support the monitoring of virtual memory usage when target Java VM consists of 64-bit processes. Therefore, when the target Java VM consists of 64-bit processes, uncheck this check box.

Default: 2048[MB]

Command (within 255 bytes) **SuspendResume**

Specify the command to execute if an error is detected in the target Java VM. It is possible to specify the command to execute for each error cause, as well as arguments. Specify a full path. Enclose an executable file name with double quotes (""). Example) "\Program Files\bin\command.bat" arg1 arg2

Here, specify the commands to execute if an error is detected in the Java heap area, Java non-heap area, and virtual memory usage amount of the target Java VM.

See also "Executing command corresponding to cause of each detected error".

Default: None

Initialize

Click **Initialize** to set all the items to their default values.

Thread tab

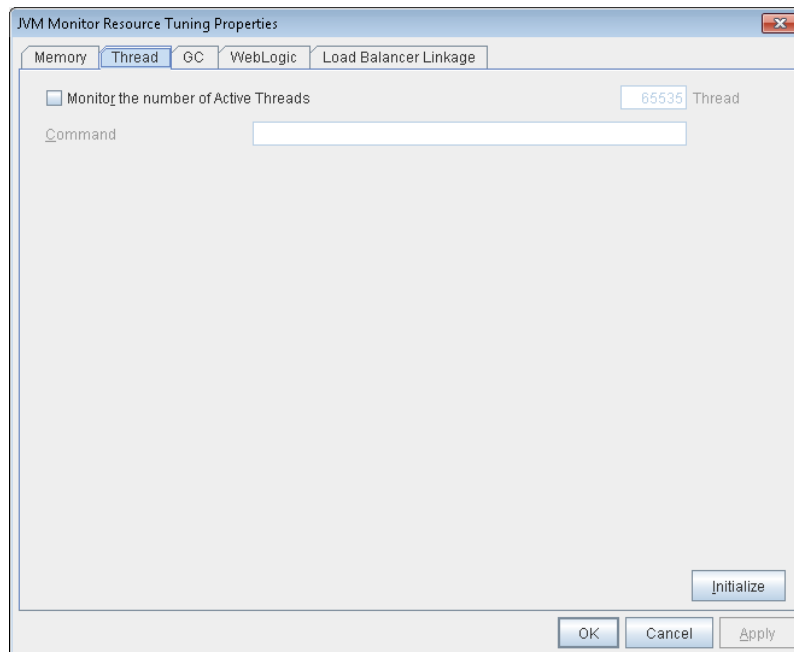

Monitor the number of Active Threads (1 to 65535) **SuspendResume**

Specify the upper limit threshold for the number of threads running on the monitor target Java VM.

Default: 65535 [threads]

Command (within 255 bytes) **SuspendResume**

Specify the command to execute if an error is detected in the target Java VM. It is possible to specify the command to execute for each error cause, as well as arguments. Specify a full path. Enclose an executable file name with double quotes ("). Example) "Program Files\bin\command.bat" arg1 arg2

Here, specify the command to execute if an error is detected in the number of threads currently running in the target Java VM.

See also "Executing command corresponding to cause of each detected error".

Default: None

Initialize

Click **Initialize** to set all the items to their default values.

GC tab

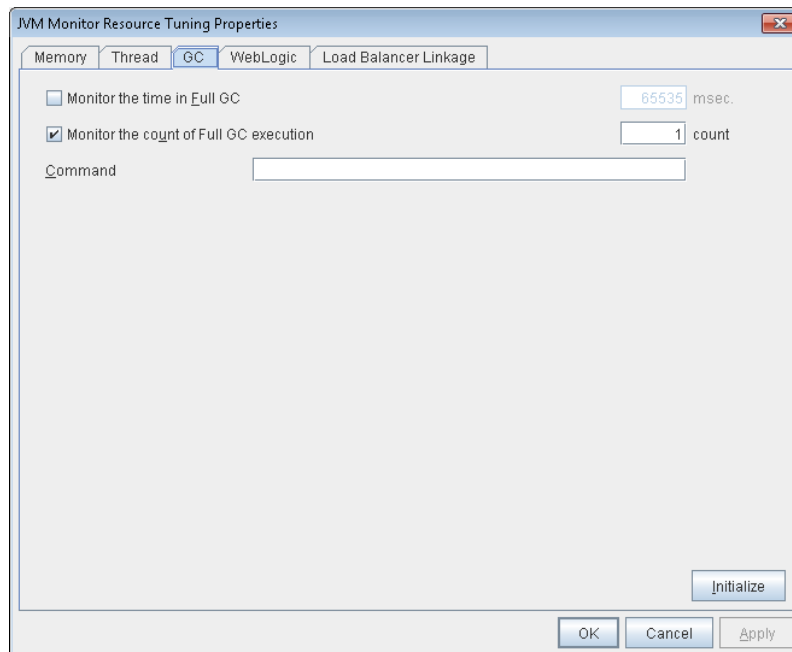

Monitor the time in Full GC (1 to 65535) **Suspend/Resume**

Specify the threshold for the Full GC execution time since previous measurement on the target Java VM. The threshold for the Full GC execution time is the average obtained by dividing the Full GC execution time by the number of times Full GC occurs since the previous measurement.

To determine the case in which the Full GC execution time since the previous measurement is 3000 milliseconds and Full GC occurs three times as an error, specify 1000 milliseconds or less.

Default: 65535 [milliseconds]

Monitor the count of Full GC execution (1 to 65535) **Suspend/Resume**

Specify the threshold for the number of times Full GC occurs since previous measurement on the target Java VM.

Default: 1 (time)

Command (within 255 bytes) **Suspend/Resume**

Specify the command to execute if an error is detected in the target Java VM. It is possible to specify the command to execute for each error cause, as well as arguments. Specify a full path. Enclose an executable file name with double quotes (""). Example) "\\Program Files\bin\command.bat" arg1 arg2

Here, specify the commands to execute if an error is detected in the Full GC execution time and Full GC execution count of the target Java VM.

See also "Executing command corresponding to cause of each detected error".

Default: None

Initialize

Click **Initialize** to set all the items to their default values.

WebLogic tab

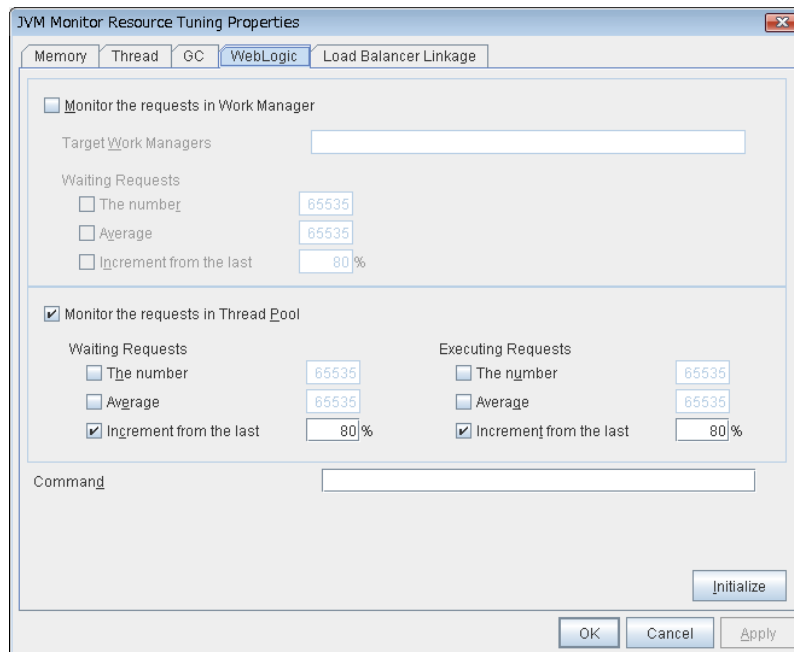

Monitor the requests in Work Manager **Suspend/Resume**

Enables the monitoring of the wait requests by Work Managers on the WebLogic Server.

- When the checkbox is selected:
Monitoring enabled
- When the checkbox is not selected: (default):
Monitoring disabled

Target Work Managers **Suspend/Resume**

Specify the names of the Work Managers for the applications to be monitored on the target WebLogic Server. To monitor Work Managers, you must specify this setting.

App1[*WM1*,*WM2*,...];*App2*[*WM1*,*WM2*,...];...

For *App* and *WM*, only ASCII characters are valid (except Shift_JIS codes 0x005C and 0x00A1 to 0x00DF).

To specify an application that has an application archive version, specify “application_name#version” in *App*.

When the name of the application contains “[and/or “]”, prefix it with \.

(Ex.) When the application name is app[2], enter app\[2\].

Default: None

The number (1 to 65535) **Suspend/Resume**

Specify the threshold for the wait request count for the target WebLogic Server Work Manager(s).

Default: 65535

Average (1 to 65535) **SuspendResume**

Specify the threshold for the wait request count average for the target WebLogic Server Work Manager(s).

Default: 65535

Increment from the last (1 to 1024) **SuspendResume**

Specify the threshold for the wait request count increment since the previous measurement for the target WebLogic Server Work Manager(s).

Default: 80[%]

Monitor the requests in Thread Pool **SuspendResume**

Enables the monitoring of the number of wait requests (number of HTTP requests queued in the WebLogic Server) and the number of executing requests (number of HTTP requests queued in the WebLogic Server) in the target WebLogic Server thread pool.

- When the checkbox is selected:
Monitoring enabled
- When the checkbox is not selected: (default):
Monitoring disabled

Wait Requests The number (1 to 65535) **SuspendResume**

Specify the threshold for the wait request count.

Default: 65535

Wait Request Average (1 to 65535) **SuspendResume**

Specify the threshold for the wait request count average.

Default: 65535

Wait Request Increment from the last (1 to 1024) **SuspendResume**

Specify the threshold for the wait request count increment since the previous measurement.

Default: 80[%]

Executing Requests The number (1 to 65535) **SuspendResume**

Specify the threshold for the number of requests executed per unit of time.

Default: 65535

Executing Requests Average (1 to 65535) **SuspendResume**

Specify the threshold for the average count of requests executed per unit of time.

Default: 65535

Executing Requests Increment from the last (1 to 1024) **SuspendResume**

Specify the threshold for the increment of the number of requests executed per unit of time since the previous measurement.

Default: 80[%]

Command (within 255 bytes) **SuspendResume**

Specify the command to execute if an error is detected in the target Java VM. It is possible to specify the command to execute for each error cause, as well as arguments. Specify a full path. Enclose an executable file name with double quotes (""). Example) "\\Program Files\bin\command.bat"

Here, specify the commands to execute if an error is detected in the requests in the thread pool or in the work manager of the WebLogic Server.

See also "Executing command corresponding to cause of each detected error".

Default: None

Initialize

Click **Initialize** to set all the items to their default values.

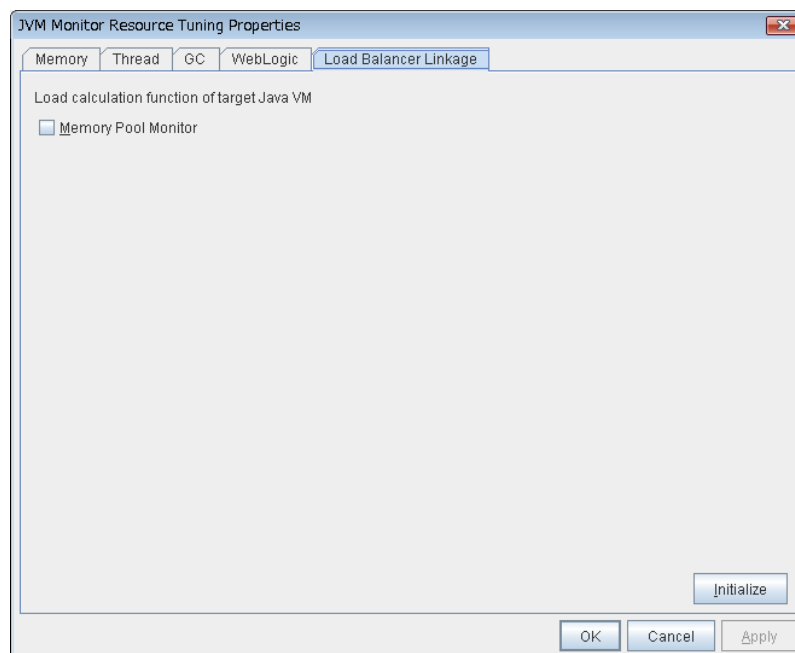
Load Balancer Linkage tab

This screen appears when an item other than **BIG-IP LTM** is selected as the load balancer type.

Memory Pool Monitor **SuspendResume**

Enables the monitoring of the memory pool when notifying the load balancer of dynamic load information.

- When the checkbox is selected:
Monitoring enabled
- When the checkbox is not selected: (default):
Monitoring disabled

Initialize

Click **Initialize** to set all the items to their default values.

Load Balancer Linkage tab(In case of BIG-IP LTM)

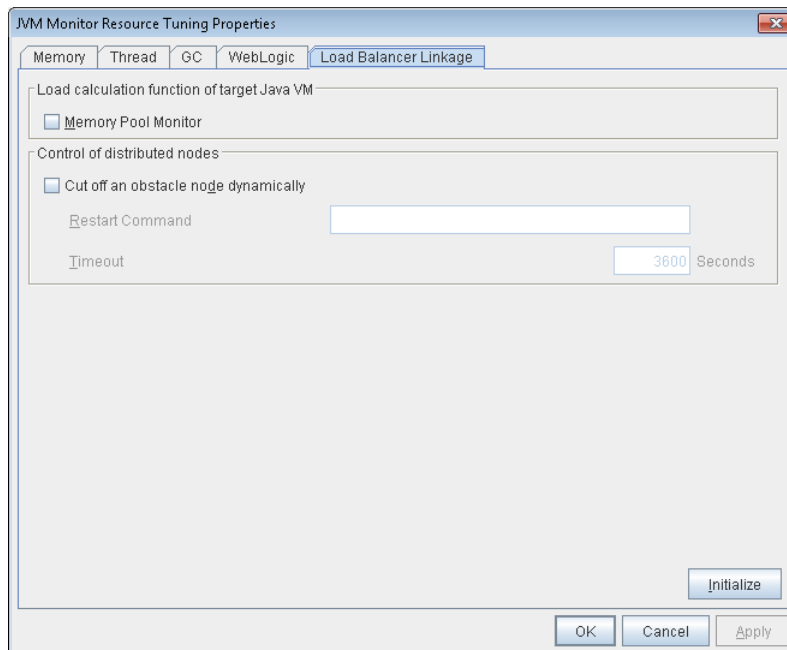

This screen appears when **BIG-IP LTM** is selected as the load balancer type.

Memory Pool Monitor **SuspendResume**

Enables the monitoring of the memory pool when notifying the load balancer of dynamic load information.

- When the checkbox is selected:
Monitoring enabled
- When the checkbox is not selected: (default):
Monitoring disabled

Cut off an obstacle node dynamically **SuspendResume**

When the JVM monitor detects a monitor target failure (example: the collection information exceeds the configured threshold), it sets whether to update the status of the BIG-IP LTM distributed node from “enable” to “disable.”

- When the checkbox is selected:
Update the status from “enable” to “disable.”
- When the checkbox is not selected: (default):
Do not update.

Restart Command **SuspendResume**

Specify the command to be executed after waiting until the number of connections of the distributed node becomes 0. This function is effective when the monitor target is rebooted when resident monitoring is performed and a monitor target failure is detected. For a restart command, specify the common value for every JVM monitor resources.

Timeout (0 to 2592000) SuspendResume

After updating the distributed node status from “enable” to “disable,” the JVM monitor sets the timeout used when waiting until the number of connections of the distributed node falls to 0. If the timeout elapses, **Restart Command** is not executed.

Default: 3600 [sec]

Initialize

Click the **Initialize** button to set **Memory Pool Monitor**, **Cut off an obstacle node dynamically**, and **Timeout** to their default values.

Displaying the JVM monitor resource properties with the WebManager

1. Start the WebManager
(http://management_IP_address_or_cluster_server_IP_address:port_number (default: 29003)).
2. When you click an object for a JVM monitor resource  in the tree view, the following information is displayed in the list view.

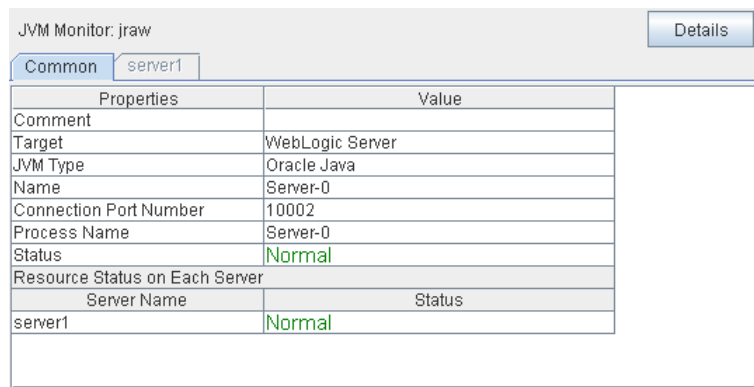

- | | |
|--------------------------------|--|
| Comment | Comment of the JVM monitor resource |
| Target: | Name of the target application server |
| JVM Type: | Java VM on which the target application server runs |
| Name: | Name that uniquely identifies the target Java VM |
| Connection Port Number: | Number of port used to establish a connection to the target Java VM |
| Process Name: | Character string that uniquely identifies the target Java VM process |
| Status: | Status of the JVM monitor resource |
| Resource Status on Each Server | |
| Server Name: | Name of the server |
| Status: | Monitor source status on the server |

When you click **Details**, the following information is displayed in the pop-up dialog box.

Properties	Value
Name	jraw1
Type	jraw
Monitor Timing	Activating
Target Resource	appli1
Interval	60
Timeout	120
Do Not Retry at Timeout Occurrence	Off
Do Not Execute Recovery Action at Timeout Occurrence	Off
Retry Count	1
Final Action	No operation
Execute Script Before Reactivation	Off
Execute Script before Failover	Off
Execute Script before Final Action	Off
Recovery Target	LocalServer
Recovery Target Type	Itself
Recovery Script Threshold	0
Reactivation Threshold	0
Failover Target Server	Stable Server
Failover Threshold	0
Wait Time to Start Monitoring	0
Dummy Failure Possibility	Possible
Collect Dump at Timeout Occurrence	Off
Run Migration Before Run Failover	Off

Name:	JVM monitor resource name
Type:	Monitor resource type
Monitor Timing:	Timing to start monitoring
Target Resource:	Resource to be monitored
Interval:	Interval between monitoring (in seconds)
Timeout:	Timeout for monitor resource error detection after detecting a monitor target error (in seconds)
Do Not Retry at Timeout Occurrence:	Whether or not to retry when timeout occurs
Do Not Execute Recovery Action at Timeout Occurrence:	Whether or not to execute recovery action when timeout occurs
Retry Count:	The number of retries to detect an error with the monitor resource after detecting a monitor target error
Final Action:	Final action at detection of an error
Execute Script before Reactivation:	Whether the pre-reactivation script is executed upon the detection of an error
Execute Script before Failover:	Whether the pre-failover script is executed upon the detection of an error
Execute Script before Final Action:	Whether the pre-final-action script is executed upon the detection of an error
Recovery Target:	Target to be recovered when an error is detected
Recovery Target Type:	Type of the target to be recovered when an error is detected
Recovery Script Threshold:	The number of times the recovery script is executed upon the detection of an error
Reactivation Threshold:	The number of reactivations to be made at detection of an error
Failover Target Server:	Determination method of Failover Target Server
Failover Threshold:	The number of failovers to be made at detection of an error
Wait Time to Start Monitoring:	Time to wait before starting monitoring (in seconds)
Dummy Failure Possibility:	Possibility of Dummy Failure
Collect Dump at Timeout Occurrence:	Whether or not dump is collected when timeout occurs
Run Migration Before Run Failover:	Whether or not migration is run before running failover

Understanding system monitor resources

System monitor resources monitor the resources used by processes. The resources periodically collect statistical information about resources used by processes and analyze the information according to given knowledge data. System monitor resources serve to detect the exhaustion of resources early according to the results of analysis.

Notes on system monitor resource

System Resource Agent may output operation logging for each monitoring operation. Configure System Resource Agent according to the desired logging output settings.

For the recovery target, specify the resource to which fail-over is performed upon the detection of an error in resource monitoring by System Resource Agent.

The use of the default System Resource Agent settings is recommended.

Errors in resource monitoring may be undetectable when:

- A system resource value repeatedly exceeds and then falls below a threshold.

In a case like where the system is high loaded, it may take a long time to collect statistical information and the interval of statistical information collection may be unapplied.

When a service of System Resource Agent stops, a pop-up dialog box may show a message telling that the stop sequence did not end within the specified duration of time. Click the **OK** button to the message to close the dialog box, and then wait until the service gets to the “stopped” status.

If date or time of OS has been changed during System Resource Agent's operation, resource monitoring may operate wrongly as follows since the timing of analyze which is normally done at 10 minute intervals may be changed at first time after changing date or time. In such case, suspend and resume cluster.

- Error is not detected after passing specified duration to detect error.
- Error is detected before passing specified duration to detect error.

Once the cluster has been suspended and resumed, the collection of information is started from that point of time.

The amount of process resources and system resources used is analyzed at 10-minute intervals. Thus, an error may be detected up to 10 minutes after the monitoring session.

The amount of disk resources used is analyzed at 60-minute intervals. Thus, an error may be detected up to 60 minutes after the monitoring session.

Specify a smaller value than the actual disk size when specifying the disk size for free space monitoring of disk resources. If a larger value specified, a lack-of-free-space error will be detected.

If the monitored disk is exchanged, the following information analyzed up to then will be cleared if it differs from the information in the previous disk:

- Total disk capacity
- File system

For servers in which no swap areas are allocated, uncheck monitoring the total usage of virtual memory.

When monitoring disk resources, only hard disks can be monitored.

Up to 26 disk units can be simultaneously monitored by the disk resource monitoring function.

If **system monitor** is not displayed in the **Type** column on the monitor resource definition screen, select **Get License Info** and then acquire the license information.

The status of the system monitor resource is Warning from when start of monitoring is enabled to when the monitoring processing is actually performed. In this status, the following message is output to the alert log.

Monitor srav is in the warning status. (100 : not ready for monitoring.)

Monitoring by system monitor resources

System monitor resources monitor the following:

Periodically collect the amounts of process resources, system resources and disk resources used and then analyze the amounts.

An error is recognized if the amount of a resource used exceeds a pre-set threshold.

When an error detected state persists for the monitoring duration, it is posted as an error detected during resource monitoring.

If process resource monitoring (of the CPU, memory, or number of threads) operated by using the default values, a resource error is reported after 24 hours.

The following chart describes how process resource monitoring detects memory usage errors.

- ◆ In the following example, as time progresses, memory usage increases and decreases, the maximum value is updated more times than specified, and increases by more than 10% from its initial value.

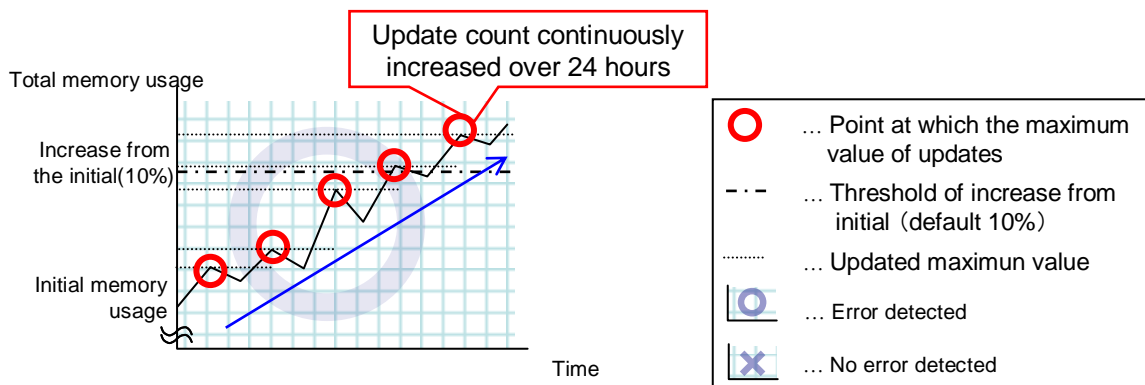

-> Memory leak will be detected as memory usage continuously increased over 24hours (by default), and it increased more than 10% from its initial value.

- ◆ In the following example, memory usage increases and decreases, but remains within a set range.

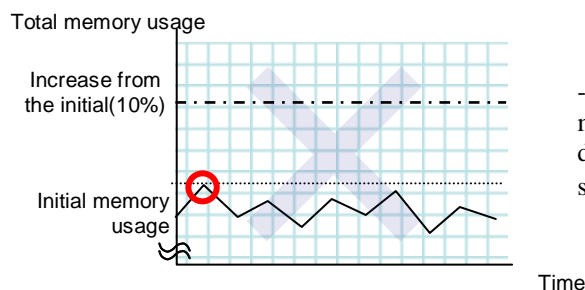

-> Memory leak will not be detected as memory usage repeat increasing and decreasing within certain range (below specific value).

System resource monitoring with the default values reports an error found in resource monitoring 60 minutes later if the resource usage does not fall below 90%.

The following shows an example of error detection for the total memory usage in system resource monitoring with the default values.

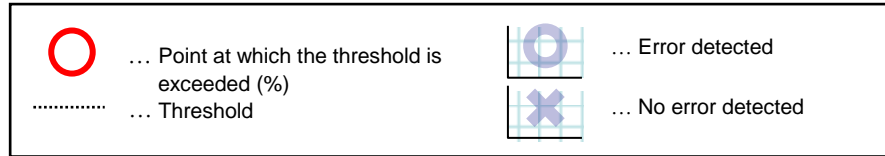

- ◆ The total memory usage remains at the total memory usage threshold or higher as time passes, for at least a certain duration of time.

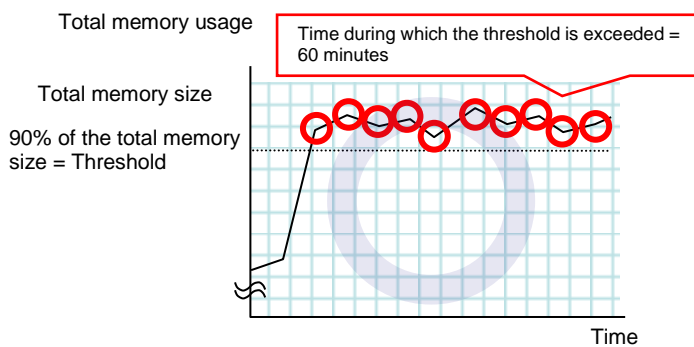

→ The total memory usage remains at the threshold (90%) or higher continuously for the monitoring duration time (60 minutes) or longer; detection of a total memory usage error is recognized.

- ◆ The total memory usage rises and falls in the vicinity of the total memory usage threshold as time passes, but always remains under that threshold.

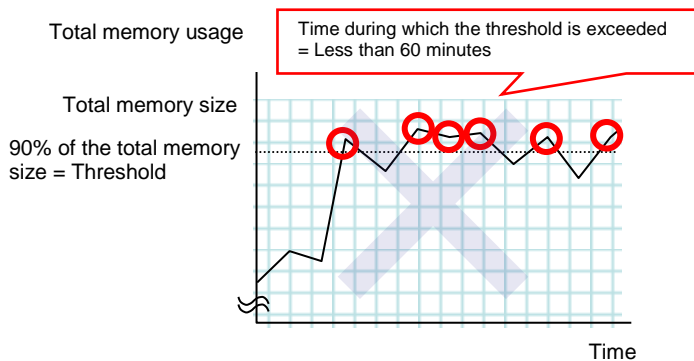

→ The total memory usage is temporarily at the total memory usage threshold (90%) or higher, but goes below the threshold before it remains at the threshold or higher continuously for the monitoring duration time (60 minutes); no total memory usage error is detected.

If disk resource monitoring operated under the default settings, it will report a notice level error after 24 hours.

The following chart describes how disk resource monitoring detects disk usage errors when operating under the default settings.

Monitoring disk usage by warning level

- ◆ In the following example, disk usage exceeds the threshold which is specified as the warning level upper limit.

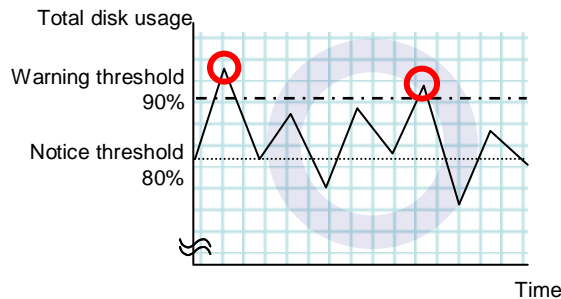

-> Disk usage error will be detected as disk usage exceed the threshold which configured as warning level upper limit.

- ◆ In the following example, disk usage increases and decreases within certain range, and does not exceed the threshold which is specified as the warning level upper limit.

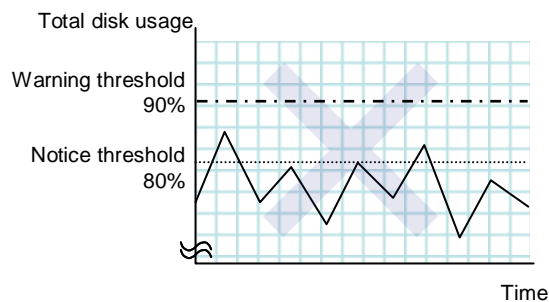

-> Disk usage error will not be detected as disk usage repeat increasing and decreasing within certain range(below warning level upper limit).

Monitoring disk usage by notice level

- ◆ In the following example, disk usage continuously exceeds the threshold specified as the notification level upper limit, and the duration exceeds the set length.

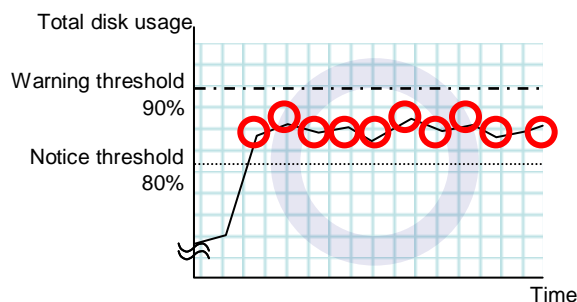

-> Disk usage error will be detected as disk usage continuously exceed notice level upper limit.

- ◆ In the following example, disk usage increases and decreases within a certain range, and does not exceed the threshold specified as the notification level upper limit.

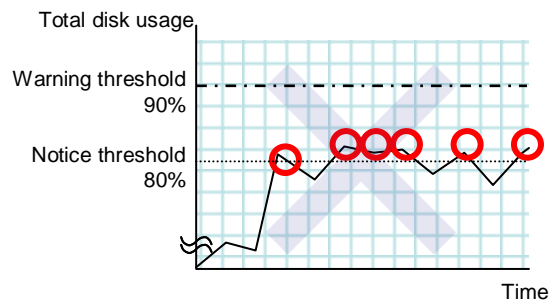

-> Disk usage error will not be detected as disk usage repeat increasing and decreasing around notice level upper limit.

Displaying and changing the system monitor resource details

1. Click the **Monitors** icon on the tree view displayed on the left side of the Builder window.
2. A list of the monitor resources is displayed in the table view on the right side of the screen. Right-click the target system monitor resource, and click the **Monitor(special)** tab in the **Monitor Resource Properties** window.
3. On the **Monitor(special)** tab, you can see and/or change the detailed settings as described below.

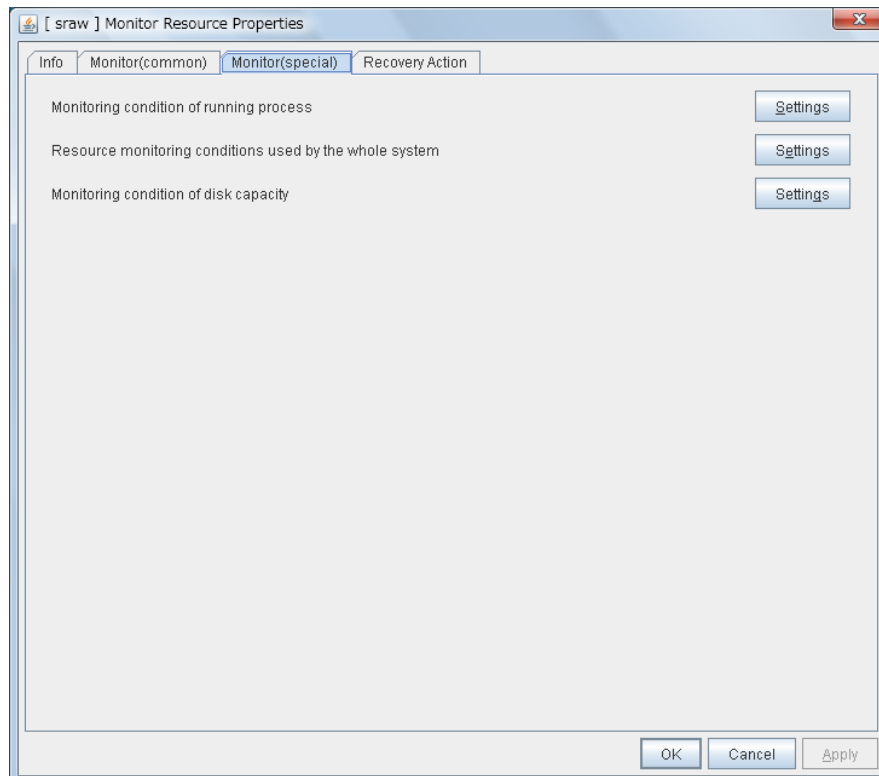

Settings

Click the **Settings** button; the following pop-up dialog box appears. Configure detailed settings for the monitoring of error detection according to the following descriptions.

Click the **Settings** button for **Process detail settings**; the process settings dialog box appears.

Click the **Settings** button for **Resource monitoring conditions used by the whole system**; the system settings dialog box appears.

Click the **Settings** button for **Monitoring disk space**; the disk list dialog box appears.

Configure detailed settings for the monitoring of error detection according to the descriptions of the dialog boxes.

System Resource Agent process settings

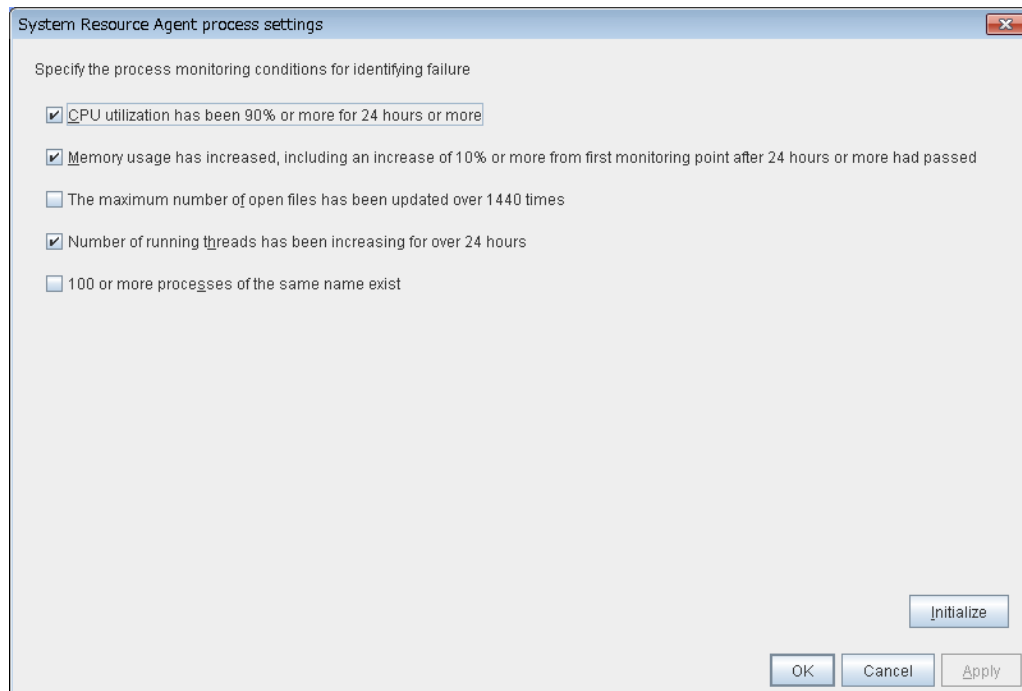

CPU utilization has been 90% or more for 24 hours or more

Enables the monitoring of processes for which CPU utilization has been continuously 90% or more for 24 hours or more.

- When the checkbox is selected:
Monitoring is enabled for processes for which CPU utilization has been continuously 90% or more for 24 hours or more.
- When the checkbox is not selected:
Monitoring is disabled for processes for which CPU utilization has been continuously 90% or more for 24 hours or more.

Memory usage has increased, including an increase of 10% or more from first monitoring point after 24 hours or more had passed

Enables the monitoring of processes for which the memory usage has increased, including an increase of 10% or more from the first the monitoring point after 24 hours or more had passed.

- When the checkbox is selected:
Monitoring is enabled for processes for which the memory usage has increased, including an increase of 10% or more from the first monitoring point after 24 hours or more has passed.
- When the checkbox is not selected:
Monitoring is disabled for processes for which the memory usage has increased, including an increase of 10% or more from the first monitoring point after 24 hours or more has passed.

The maximum number of open files has been updated over 1440 times

Enables the monitoring of processes for which the maximum number of open files has been exceeded over 1440 times.

- When the checkbox is selected:
Monitoring is enabled for processes for which the maximum number of open files has been exceeded over 1440 times.
- When the checkbox is not selected:
Monitoring is disabled for processes for which the maximum number of open files has been exceeded over 1440 times.

Number of running threads has been increasing for over 24 hours

Enables the monitoring of processes for which the number of running threads has been increasing for over 24 hours.

- When the checkbox is selected:
Monitoring is enabled for processes for which the number of running threads has been increasing for over 24 hours.
- When the checkbox is not selected:
Monitoring is disabled for processes for which the number of running threads has been increasing for over 24 hours.

100 or more processes of the same name exist

Enables the monitoring of processes for which there are 100 or more processes having the same name.

- When the checkbox is selected:
Monitoring is enabled for processes for which there are 100 or more processes having the same name.
- When the checkbox is not selected:
Monitoring is disabled for processes for which there are 100 or more processes having the same name.

System Resource Agent system settings

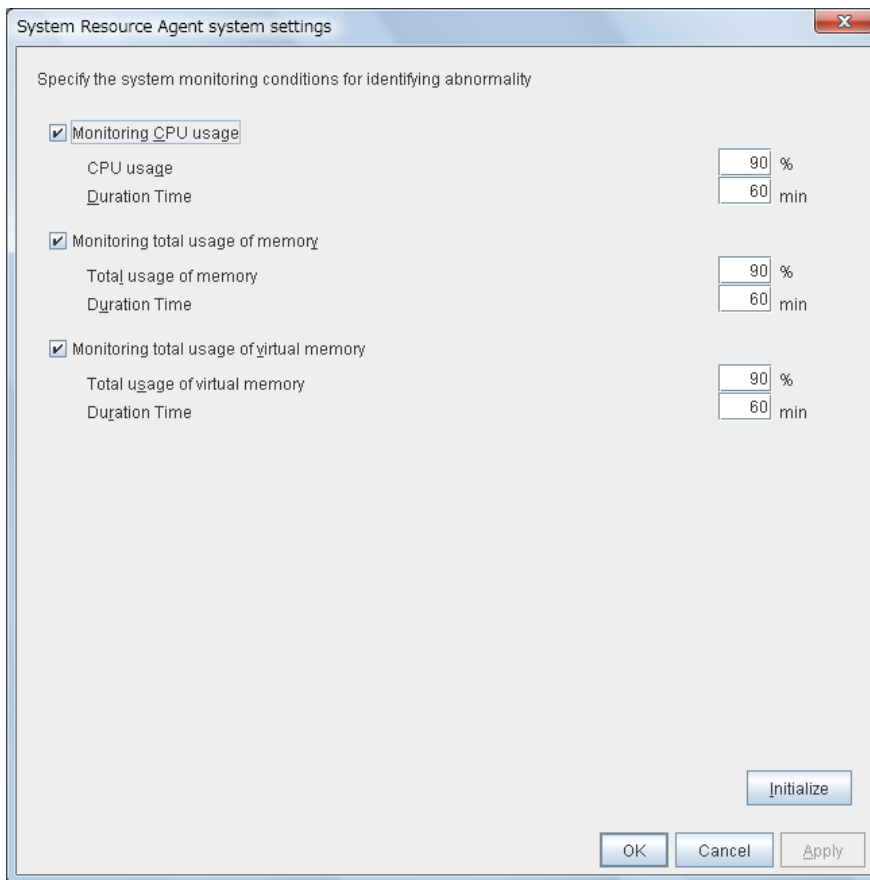

Monitoring CPU usage

Enables CPU usage monitoring.

- When the checkbox is selected:
Monitoring is enabled for the CPU usage.
- When the checkbox is not selected:
Monitoring is disabled for the CPU usage.

CPU usage (0 to 100)

Specify the threshold for the detection of the CPU usage.

Duration Time (1 to 1440)

Specify the duration for detecting the CPU usage.

If the threshold is continuously exceeded over the specified duration, the detection of an error is recognized.

Monitoring total usage of memory

Enables the monitoring of the total usage of memory.

- When the checkbox is selected:
Monitoring is enabled for the total usage of memory.

- When the checkbox is not selected:
Monitoring is disabled for the total usage of memory.

Total usage of memory (0 to 100)

Specify the threshold for the detection of a memory use amount error (percentage of the memory size implemented on the system).

Duration Time (1 to 1440)

Specify the duration for detecting a total memory usage error.

If the threshold is continuously exceeded over the specified duration, the detection of an error is recognized.

Monitoring total usage of virtual memory

Enables the monitoring of the total usage of virtual memory.

- When the checkbox is selected:
Monitoring is enabled for the total usage of virtual memory.
- When the checkbox is not selected:
Monitoring is disabled for the total usage of virtual memory.

Total usage of virtual memory (0 to 100)

Specify the threshold for the detection of a virtual memory usage error.

Duration Time (1 to 1440)

Specify the duration for detecting a total virtual memory usage error.

If the threshold is continuously exceeded over the specified duration, the detection of an error is recognized.

System Resource Agent disk list

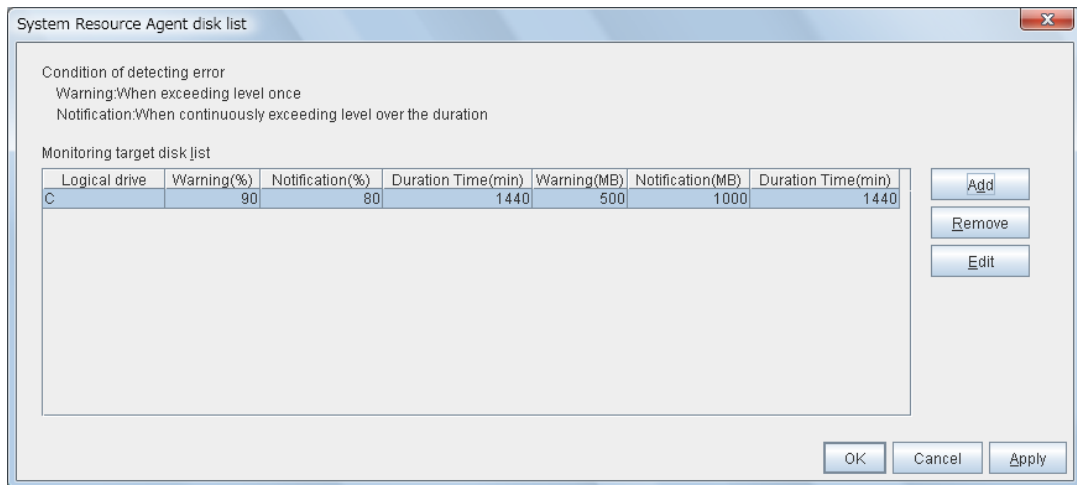

Add

Click this to add disks to be monitored. The **Input of watch condition** dialog box appears.

Configure the detailed monitoring conditions for error determination, according to the descriptions given in the **Input of watch condition** dialog box.

Remove

Click this to remove a disk selected in **Disk List** so that it will no longer be monitored.

Edit

Click this to display the **Input of watch condition** dialog box. The dialog box shows the monitoring conditions for the disk selected in **Disk List**. Edit the conditions and click **OK**.

The screenshot shows a dialog box titled "Specify monitoring condition". It has a "Logical drive" field containing "C". Under "Monitor Type", there are two sections. The first section, "Utilization rate", has a checked checkbox and three input fields: "Warning level" (90%), "Notice level" (80%), and "Duration Time" (1440 min). The second section, "Free space", also has a checked checkbox and three input fields: "Warning level" (500 MB), "Notice level" (1000 MB), and "Duration Time" (1440 min). At the bottom right, there are three buttons: "Initialize", "OK", and "Cancel".

Logical drive

Set the logical drive to be monitored.

Utilization rate

Enables the monitoring of the disk usage.

- When the checkbox is selected:
Monitoring is enabled for the disk usage.
- When the checkbox is not selected:
Monitoring is disabled for the disk usage.

Warning level (1 to 100)

Specify the threshold for warning level error detection for disk usage.

Notice level (1 to 100)

Specify the threshold for notice level error detection for disk usage.

Duration Time (1 to 43200)

Specify the duration for detecting a notice level error of the disk usage rate.

If the threshold is continuously exceeded over the specified duration, the detection of an error is recognized.

Free space

Enables the monitoring of the free disk space.

- When the checkbox is selected:
Monitoring is enabled for the free disk space.

- When the checkbox is not selected:
Monitoring is disabled for the free disk space.

Warning level (1 to 4294967295)

Specify the amount of disk space (in megabytes) for which the detection of an free disk space error at the warning level is recognized.

Notice level (1 to 4294967295)

Specify the amount of disk space (in megabytes) for which the detection of an free disk space error at the notice level is recognized.

Duration Time (1 to 43200)

Specify the duration for detecting a notice level error related to the free disk space.

If the threshold is continuously exceeded over the specified duration, the detection of an error is recognized.

Displaying the system monitor resource properties with the WebManager

1. Start the WebManager
([http://managemnt_IP_address_or_cluster_server_IP_address:port_number\(default:29003\)](http://managemnt_IP_address_or_cluster_server_IP_address:port_number(default:29003))).
2. When you click an object for a system monitor resource  in the tree view, the following information is displayed in the list view.

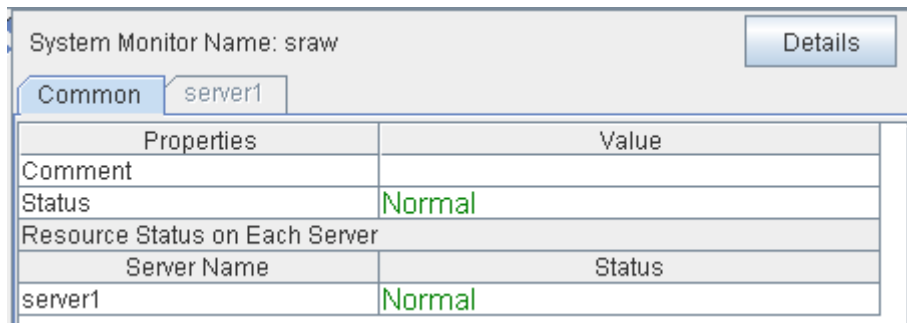

Comment: Comment on the system monitor resource
 Status: Status of the system monitor resource

Resource Status on Each Server:
 Server Name: Name of the server
 Status: Status of the monitor resource on the server

When you click **Details**, the following information is displayed in the pop-up dialog box.

Properties	Value
Name	sraw1
Type	sraw
Monitor Timing	Always
Target Resource	
Interval	30
Timeout	60
Do Not Retry at Timeout Occurrence	Off
Do Not Execute Recovery Action at Timeout Occurrence	Off
Retry Count	0
Final Action	No operation
Execute Script Before Reactivation	Off
Execute Script Before Failover	Off
Execute Script before Final Action	Off
Recovery Target	LocalServer
Recovery Target Type	Itself
Recovery Script Threshold	0
Reactivation Threshold	0
Failover Target Server	Stable Server
Failover Threshold	0
Wait Time to Start Monitoring	0
Dummy Failure Possibility	Possible
Collect Dump at Timeout Occurrence	Off
Run Migration Before Run Failover	Off
System : Monitoring CPU Usage	On
System : CPU Rate (%)	90
System : CPU Monitoring Duration (sec)	3600
System : Monitoring Memory Usage	On
System : Memory Usage Rate (%)	90
System : Memory Usage Monitoring Duration (sec)	3600
System : Monitoring Virtual Memory	On
System : Virtual Memory(VM) Usage Rate (%)	90
System : VM Usage Monitoring Duration (sec)	3600
Process : Monitoring CPU Usage	On
Process : Monitoring Memory Leak	On
Process : Monitoring File Leak	On
Process : Monitoring Thread Leak	On
Process : Monitoring Same Name Process Count	Off
Disk : Logical Drive	

- Name: System monitor resource name
- Type: Monitor resource type
- Monitor Timing: Timing to start monitoring
- Target Resource: Resource to be monitored
- Interval: Interval between monitoring (in seconds)
- Timeout: Timeout for monitor resource error detection after detecting a monitor target error (in seconds)
- Do Not Retry at Timeout Occurrence: Whether or not to retry when timeout occurs
- Do Not Execute Recovery Action at Timeout Occurrence: Whether or not to execute recovery action when timeout occurs
- Retry Count: The number of retries to detect an error with the monitor resource after detecting a monitor target error
- Final Action: Final action at detection of an error
- Execute Script before Reactivation: Whether the pre-reactivation script is executed upon the detection of an error
- Execute Script before Failover: Whether the pre-failover script is executed upon the detection of an error
- Execute Script before Final Action: Whether the pre-final-action script is executed upon the detection of an error
- Recovery Target: Target to be recovered when an error is detected
- Recovery Target Type: Type of the target to be recovered when an error is detected

Recovery Script Threshold:	The number of times the recovery script is executed upon the detection of an error
Reactivation Threshold:	The number of reactivations to be made at detection of an error
Failover Target Server:	How to specify the failover target
Failover Threshold:	The number of failovers to be made at detection of an error
Wait Time to Start Monitoring:	Time to wait before starting monitoring (in seconds)
Dummy Failure Possibility:	Possibility of Dummy Failure
Collect Dump at Timeout Occurrence:	Whether or not dump is collected when timeout occurs
Run Migration Before Run Failover:	Whether or not migration is run before running failover
System: Monitoring CPU Usage:	CPU usage monitoring enabled/disabled
System: CPU Rate (%):	Threshold for detection of the CPU usage error (%)
System: CPU Monitoring Duration (sec):	Duration for detecting a CPU usage error (seconds)
System: Monitoring Memory Usage:	Memory usage monitoring enabled/disabled
System: Memory Usage Rate (%):	Threshold for detection of a memory usage error (%)
System: Memory Usage Monitoring Duration (sec):	Duration for detecting a memory usage error (seconds)
System: Monitoring Virtual Memory Usage:	Virtual memory usage monitoring enabled/disabled
System: Virtual Memory(VM) Usage Rate (%):	Threshold for detection of a virtual memory usage error (%)
System: VM Usage Monitoring Duration (sec):	Duration for detecting a virtual memory usage error (seconds)
Process: Monitoring CPU Usage:	CPU usage monitoring enabled/disabled
Process: Monitoring Memory Leak:	Memory leak monitoring enabled/disabled
Process: Monitoring File Leak:	File leak monitoring enabled/disabled
Process: Monitoring Thread Leak:	Thread leak monitoring enabled/disabled
Process: Monitoring Same Name Process Count:	Process multiplicity monitoring enabled/disabled
Disk: Logical Drive:	Logical drive at which the disk subject to the system monitor resource monitoring is mounted

Understanding user space monitor resources

The user space monitor resources monitor any user space stalls.

Monitoring by user space monitor resources

The user space monitor resources monitor the following:

After the start of monitoring, a user space monitor resource starts the keepalive timer and then updates the keepalive timer at monitoring intervals. It detects an error if the timer is not updated during a set duration as a result of a user space stall.

A user space monitor resource has a setting for extending the monitoring by creating a dummy thread. If this setting is enabled, it creates a dummy thread at monitoring intervals. If it fails to create a dummy thread, it does not update the keepalive timer.

The processing logic of the user space monitor resources is as follows:

- ◆ Overview of processing

The following steps 2 and 3 are repeated.

1. Set the keepalive timer
2. Create a dummy thread
3. Update the keepalive timer

Step 2 is a process for advanced monitor setting. If this is not set, the process is not started.

- ◆ Behavior when a timeout does not occur (steps 2 and 3, above, are processed properly)

Recovery processing such as reset is not executed.

- ◆ Behavior when a timeout occurs (Either of steps 2 or 3, above, is stopped or delayed)

According to the action settings, a reset or panic is generated by the clphb driver.

Displaying and changing the details of user space monitor resources

1. From the tree view displayed in the left pane of the Builder, click the monitor resource icon.
2. A list of the monitor resources is displayed in the table view on the right side of the window. Right-click the target user space monitor resource name, and then click **Properties** on the shortcut menu. In **Properties**, click the **Monitor (special)** tab.
3. Display and/or change the detailed settings on the **Monitor (special)** tab as described below.

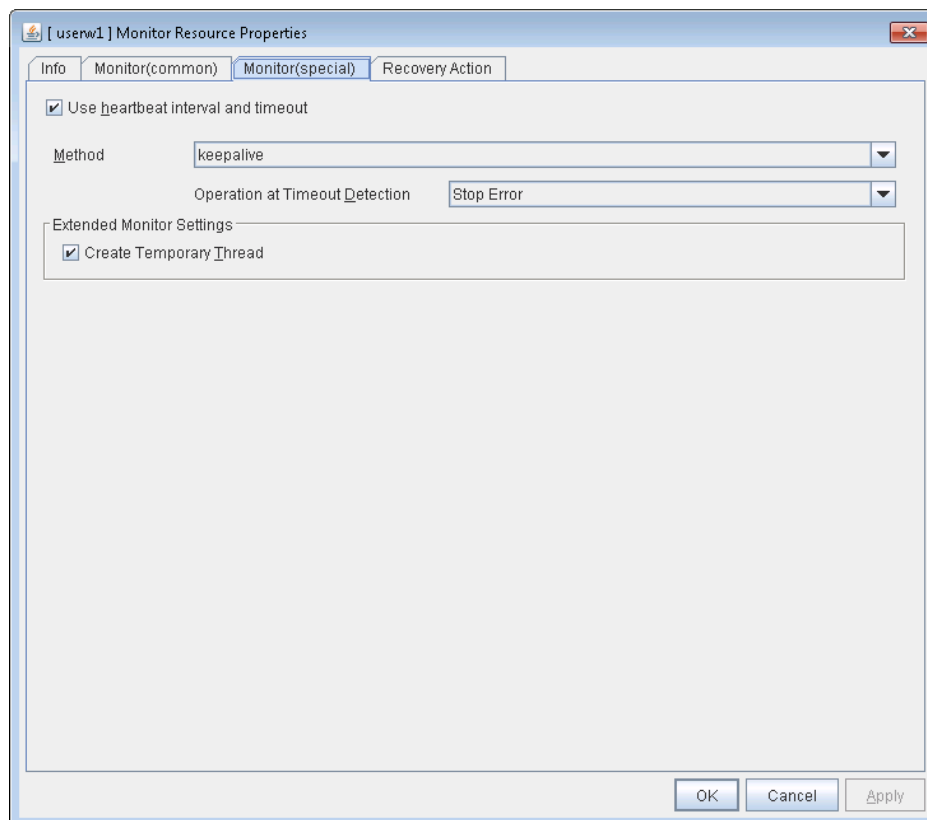

Use Heartbeat Interval/Timeout **SuspendResume**

Specify whether to use the heartbeat interval and timeout as the monitoring interval and timeout.

- ◆ When this check box is selected (default)

The heartbeat interval and timeout are used.

- ◆ When this check box is not selected

The interval and timeout that are set in the **Monitor** tab are used without using the heartbeat settings. The timeout value needs to be larger than the interval value.

Monitor Method **SuspendResume**

Specify how the user space is monitored.

- ◆ keepalive

The clphb driver is used.

Action When Timeout Occurs **SuspendResume**

Specify the action to take when a timeout occurs.

- ◆ No Operation

No action is taken.

- ◆ HW Reset

Reset the hardware.

- ◆ Generate an intentional stop error

Intentionally cause a stop error.

Note:

A dummy failure cannot be triggered by an action when a timeout occurs.

Create a Dummy Thread SuspendResume

Specify whether or not to create a dummy thread when monitoring.

- ◆ When the checkbox is selected (default value)
Create a dummy thread.
- ◆ When the checkbox is not selected
Do not create a dummy thread.

Displaying the user space monitor resource properties with the WebManager

1. Start the WebManager (http://Management IP address or the IP address of the cluster server: port_number (the default value is 29003)).
2. Click the user space monitor resources object [] in the tree view. The following information is displayed in the list view:

User-Mode Monitor: userw1		Details
Common server1 server2		
Properties	Value	
Comment		
Method	keepalive	
Use HB interval and timeout	On	
Status	Normal	
Resource Status on Each Server		
Server Name	Status	
server1	Normal	
server2	Normal	

Comment	Comment of the user space monitor resource
Method	Method for monitoring
Use HB interval and timeout	Possibility of using heartbeat interval/timeout
Status	Status of the user space monitor resource
Resource Status on Each Server	
Server Name	Server name of each server
Status	Status of the monitor resource on the given server

When you click [Details], the following information is displayed in the pop-up dialog box.

Properties	Value
Name	userw
Type	userw
Monitor Timing	Always
Target Resource	
Interval	30
Timeout	300
Do Not Retry at Timeout Occurrence	Off
Do Not Execute Recovery Action at Timeout Occurrence	Off
Retry Count	0
Final Action	No operation
Execute Script Before Reactivation	Off
Execute Script Before Failover	Off
Execute Script before Final Action	Off
Recovery Target	LocalServer
Recovery Target Type	Itself
Recovery Script Threshold	0
Reactivation Threshold	0
Failover Target Server	Stable Server
Failover Threshold	Number of Servers
Wait Time to Start Monitoring	0
Dummy Failure Possibility	Possible
Collect Dump at Timeout Occurrence	Off
Run Migration Before Run Failover	Off
Operation at Timeout	Stop Error
Create Temporary Thread	On

Name	User space monitor resource name
Type	Monitor resource type
Monitor Timing	Timing to start monitoring
Target Resource	Resource to be monitored
Interval (sec)	Interval between monitoring (in seconds)
Timeout (sec)	Timeout for monitoring (in seconds)
Do Not Retry at Timeout Occurrence:	Whether or not to retry when timeout occurs
Do Not Execute Recovery Action at Timeout Occurrence:	Whether or not to execute recovery action when timeout occurs
Retry Count	The number of retries to be made from detection of an error in the monitor target to establish the error as error
Final Action	Final action at detection of an error
Execute Script before Reactivation	Whether the pre-reactivation script is executed upon the detection of an error
Execute Script before Failover	Whether the pre-failover script is executed upon the detection of an error
Execute Script before Final Action	Whether the pre-final-action script is executed upon the detection of an error
Recovery Target	Target to be recovered when an error is detected
Recovery Target Type	Type of target to be recovered when an error is detected
Recovery Script Threshold	The number of times the recovery script is executed upon the detection of an error
Reactivation Threshold:	The number of reactivations to be made at detection of an error
Failover Threshold	The number of failovers to be made at detection of an error

Wait Time to Start Monitoring (sec)	Time to wait before starting of monitoring (in seconds)
nice Value	Monitor resource nice value
Dummy Failure Possibility	Possibility of Dummy Failure
Collect Dump at Timeout Occurrence	Whether or not dump of monitor process is collected when timeout occurs
Run Migration Before Run Failover	Whether or not migration is run before running failover
Use Heartbeat Interval/Timeout	Possibility of using heartbeat interval/timeout
Monitor Method	Method for monitoring
Action When Timeout Occurs	Actions taken when timeout occurs.
Open/Close Dummy File	Possibility of opening/closing dummy file
Write	Possibility of writing to dummy file
Size	Writing size to dummy file
Create Dummy Thread	Whether or not dummy thread is created

Understanding AWS elastic ip monitor resources

For EIP control, AWS elastic ip monitor resources confirm the existence of EIPs by using the AWS CLI command.

Notes on AWS elastic ip monitor resources

- ◆ AWS elastic ip monitor resources are automatically created when AWS elastic ip resources are added. A single AWS elastic ip monitor resource is automatically created for a single AWS elastic ip resource.
- ◆ See “Setting up AWS elastic ip resources” in “Notes when creating the cluster configuration data” in Chapter 5 “Notes and Restrictions” of the *Getting Started Guide*

Applying environment variables to AWS CLI run from the AWS elastic ip monitor resource

See “Applying environment variables to AWS CLI run from the AWS elastic ip resource” in this guide

Displaying and changing the details of AWS elastic ip monitor resources

1. In the tree view shown on the left pane of the Builder, click the **Monitors** icon.
2. A list of monitor resources is shown in the table view on the right side of the screen. Right-click the target AWS elastic ip monitor resource, and click **Properties**, and then click the **Monitor(special)** tab.
3. On the **Monitor(special)** tab, you can see and/or change the detailed settings as described below.

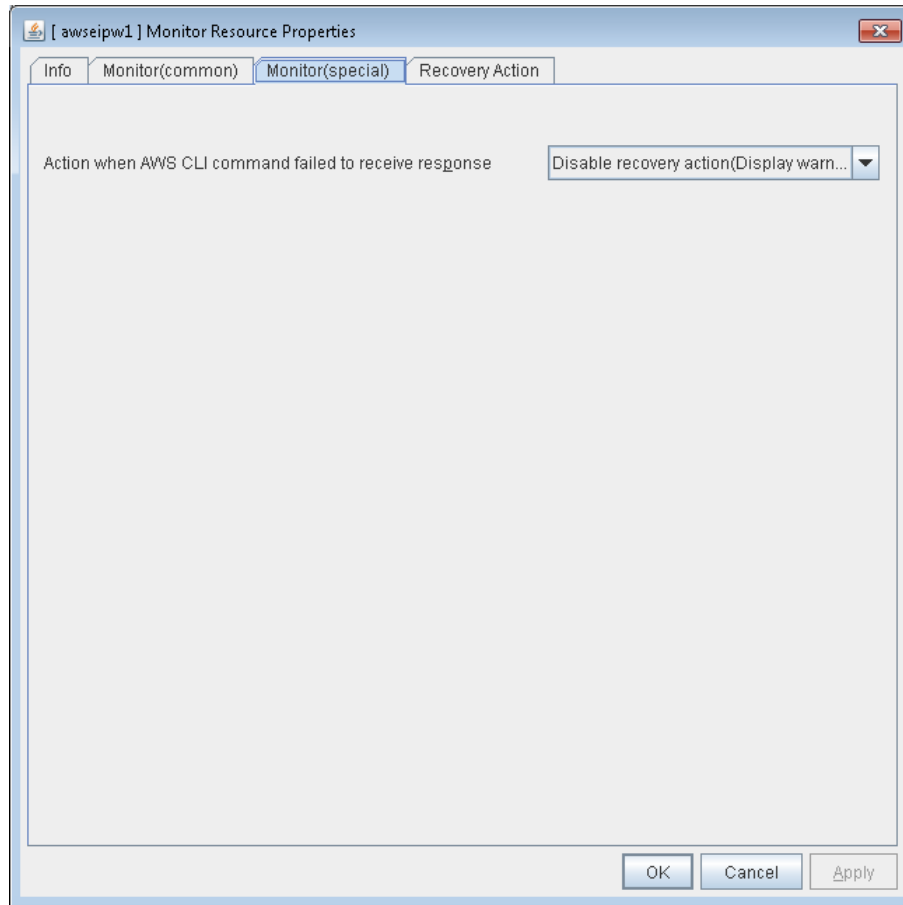

Action when AWS CLI command failed to receive response **SuspendResume**

Specify the action to be taken when acquiring the AWS CLI command response fails.

Displaying the AWS elastic ip monitor resource properties with the WebManager

1. Start the WebManager. (http://Management IP address or the IP address of the cluster server: port_number (the default value is 29003))
2. When you click an AWS elastic ip monitor object  in the tree view, the following information is displayed in the list view.

AWS Elastic IP monitor: awseipw1		Details
Common server1 server2		
Properties	Value	
Comment		
Action when AWS CLI comma...	Disable recovery action(Display warning)	
Status	Normal	
Resource Status on Each Server		
Server Name	Status	
server1	Offline	
server2	Offline	

Comment AWS elastic ip monitor resource comment
 Status Status of the AWS elastic ip monitor resource

Action when AWS CLI command failed to receive response

Action to be taken when acquiring the AWS CLI command response fails

Resource Status on Each Server

Server Name

Server name

Status

Status of the monitor resource on the given server

When you click Details, the following information is displayed in the pop-up dialog box.

Properties	Value
Name	awseipw1
Type	awseipw
Monitor Timing	Activating
Target Resource	awseip1
Interval	60
Timeout	100
Do Not Retry at Timeout Occurrence	Off
Do Not Execute Recovery Action at Timeout Occurrence	Off
Retry Count	1
Final Action	No operation
Execute Script Before Reactivation	Off
Execute Script Before Failover	Off
Execute Script before Final Action	Off
Recovery Target	awseip1
Recovery Target Type	Resource
Recovery Script Threshold	0
Reactivation Threshold	3
Failover Target Server	Stable Server
Failover Threshold	Number of Servers
Wait Time to Start Monitoring	0
Dummy Failure Possibility	Impossible
Collect Dump at Timeout Occurrence	Off
Run Migration Before Run Failover	Off

Name: AWS elastic ip monitor resource name

Type: Monitor resource type

Monitor Timing: Timing for the monitor resource to start monitoring

Target Resource: Resource to be monitored

Interval (sec): Interval between monitoring (in seconds)

Timeout (sec): Timeout for monitoring (in seconds)

Do Not Retry at Timeout Occurrence: Whether or not to retry when timeout occurs

Do Not Execute Recovery Action at Timeout Occurrence: Whether or not to execute recovery action when timeout occurs

Retry Count: The number of retries to be made from detection of an error in the monitor target to establish the error as error.

Final Action: Final action at detection of an error

Execute Script before Reactivation: Whether or not the pre-reactivation script is executed upon the detection of an error

Execute Script before Failover: Whether or not the pre-failover script is executed upon the detection of an error

Execute Script before Final Action: Whether or not the pre-final-action script is executed upon the detection of an error

Recovery Target: Target to be recovered when an error is detected

Recovery Target Type: Type of target to be recovered when an error is detected

Recovery Script Threshold: The number of times the recovery script is executed upon the detection of an error

Reactivation Threshold: The number of reactivations to be made at detection of an error

Failover Target Server: Determination method of Failover Target Server

Failover Threshold:	The number of failovers to be made at detection of an error
Wait Time to Start Monitoring (sec):	Time to wait before starting monitoring (in seconds)
Dummy Failure Possibility	Possibility of Dummy Failures
Collect Dump at Timeout Occurrence:	Whether or not dump of monitor process is collected when timeout occurs
Run Migration before Run Failover	Whether or not migration is run before running failover

Understanding AWS virtual ip monitor resources

For VIP control, AWS virtual ip monitor resources confirm the existence of VIPs and the soundness of VPC routing by using the OS API and AWS CLI commands.

AWS CLI command is executed for AWS virtual ip monitor resources while monitoring to check the route table information.

Notes on AWS virtual ip monitor resources

- ◆ AWS virtual ip monitor resources are automatically created when AWS virtual ip resources are added. A single AWS virtual ip monitor resource is automatically created for a single AWS virtual ip resource.
- ◆ See "Setting up AWS virtual ip resources" in "Notes when creating the cluster configuration data" in Chapter 5, "Notes and Restrictions" in the *Getting Started Guide*.

Applying environment variables to AWS CLI run from the AWS virtual ip monitor resource

See "Applying environment variables to AWS CLI run from the AWS virtual ip resource" in this guide.

Displaying and changing the details of AWS virtual ip monitor resources

1. In the tree view shown on the left pane of the Builder, click the **Monitors** icon.
2. A list of monitor resources is shown in the table view on the right side of the screen. Right-click the target AWS virtual ip monitor resource, and click **Properties**, and then click the **Monitor(special)** tab.
3. On the **Monitor(special)** tab, you can see and/or change the detailed settings as described below.

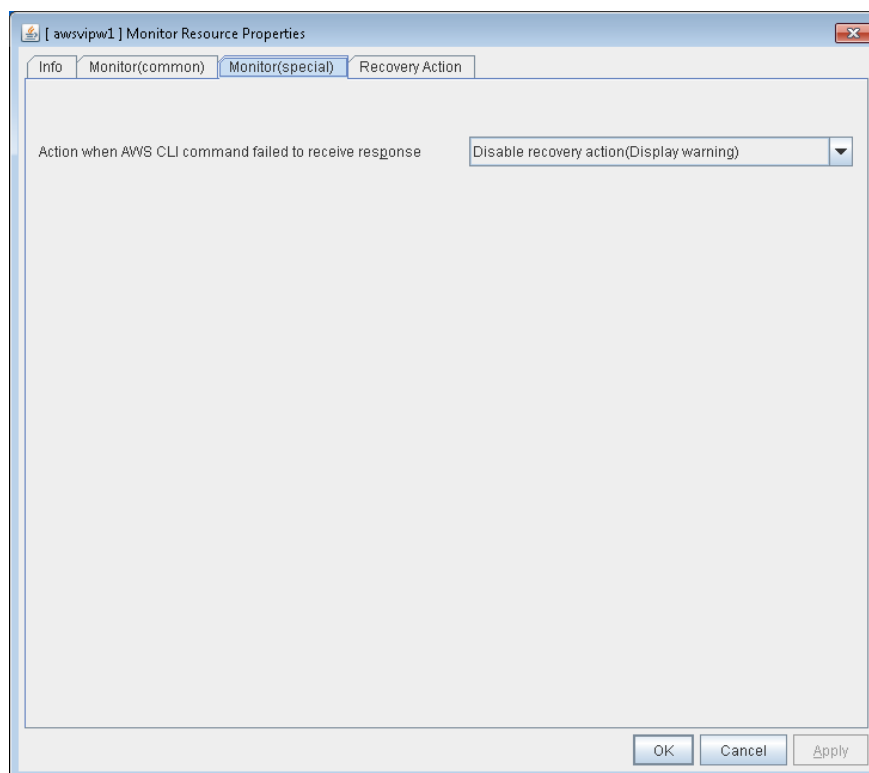
**Action when AWS CLI command failed to receive response**

Specify the action to be taken when acquiring the AWS CLI command response fails. When **Disable recovery action** is selected, a failure in the AWS CLI command (such as timeout or a credential error) is not detected even if the entry of the route table has an error. Therefore, it is recommended to select **Disable recovery action(Display warning)**.

When you click Details, the following information is displayed in the pop-up dialog box.

Properties	Value
Name	awsvipw1
Type	awsvipw
Monitor Timing	Activating
Target Resource	awsvip1
Interval	60
Timeout	100
Do Not Retry at Timeout Occurrence	Off
Do Not Execute Recovery Action at Timeout Occurrence	Off
Retry Count	1
Final Action	No operation
Execute Script Before Reactivation	Off
Execute Script Before Failover	Off
Execute Script before Final Action	Off
Recovery Target	awsvip1
Recovery Target Type	Resource
Recovery Script Threshold	0
Reactivation Threshold	3
Failover Target Server	Stable Server
Failover Threshold	Number of Servers
Wait Time to Start Monitoring	0
Dummy Failure Possibility	Impossible
Collect Dump at Timeout Occurrence	Off
Run Migration before Run Failover	Off

Name:	AWS virtual ip monitor resource name
Type:	Monitor resource type
Monitor Timing:	Timing for the monitor resource to start monitoring
Target Resource:	Resource to be monitored
Interval (sec):	Interval between monitoring (in seconds)
Timeout (sec):	Timeout for monitoring (in seconds)
Do Not Retry at Timeout Occurrence:	Whether or not to retry when timeout occurs
Do Not Execute Recovery Action at Timeout Occurrence:	Whether or not to execute recovery action when timeout occurs
Retry Count:	The number of retries to be made from detection of an error in the monitor target to establish the error as error.
Final Action:	Final action at detection of an error
Execute Script before Reactivation:	Whether or not the pre-reactivation script is executed upon the detection of an error
Execute Script before Failover:	Whether or not the pre-failover script is executed upon the detection of an error
Execute Script before Final Action:	Whether or not the pre-final-action script is executed upon the detection of an error
Recovery Target:	Target to be recovered when an error is detected
Recovery Target Type:	Type of target to be recovered when an error is detected
Recovery Script Threshold:	The number of times the recovery script is executed upon the detection of an error
Reactivation Threshold:	The number of reactivations to be made at detection of an error
Failover Target Server:	Determination method of Failover Target Server
Failover Threshold:	The number of failovers to be made at detection of an error
Wait Time to Start Monitoring (sec):	Time to wait before starting monitoring (in seconds)
Dummy Failure Possibility	Possibility of Dummy Failures
Collect Dump at Timeout Occurrence:	Whether or not dump of monitor process is collected when timeout occurs
Run Migration before Run Failover	Whether or not migration is run before running failover

Understanding AWS AZ monitor resources

AWS AZ monitor resources monitor the soundness of the AZ to which each server belongs, by using the AWS CLI command.

When the AZ status obtained by using AWS CLI command is anything other than “available”, it causes an error.

Notes on AWS AZ monitor resources

- ◆ When monitoring an AZ, create a single AWS AZ monitor resource.
- ◆ See "Setting up AWS elastic ip resources" and "Setting up AWS virtual ip resources" in "Notes when creating the cluster configuration data " in Chapter 5, "Notes and Restrictions" in the *Getting Started Guide*.

Applying environment variables to AWS CLI run from the AWS AZ monitor resource

See “Applying environment variables to AWS CLI run from the AWS virtual ip resource” in this guide.

Displaying and changing the details of AWS AZ monitor resources

1. In the tree view shown on the left pane of the Builder, click the **Monitors** icon.
2. The list of monitor resources is shown in the table view on the right side of the screen. Right-click the desired AWS AZ monitor resource name. Then click **Properties** and select the **Monitor(special)** tab.
3. On the **Monitor(special)** tab, you can display and/or change the settings by following the description below.

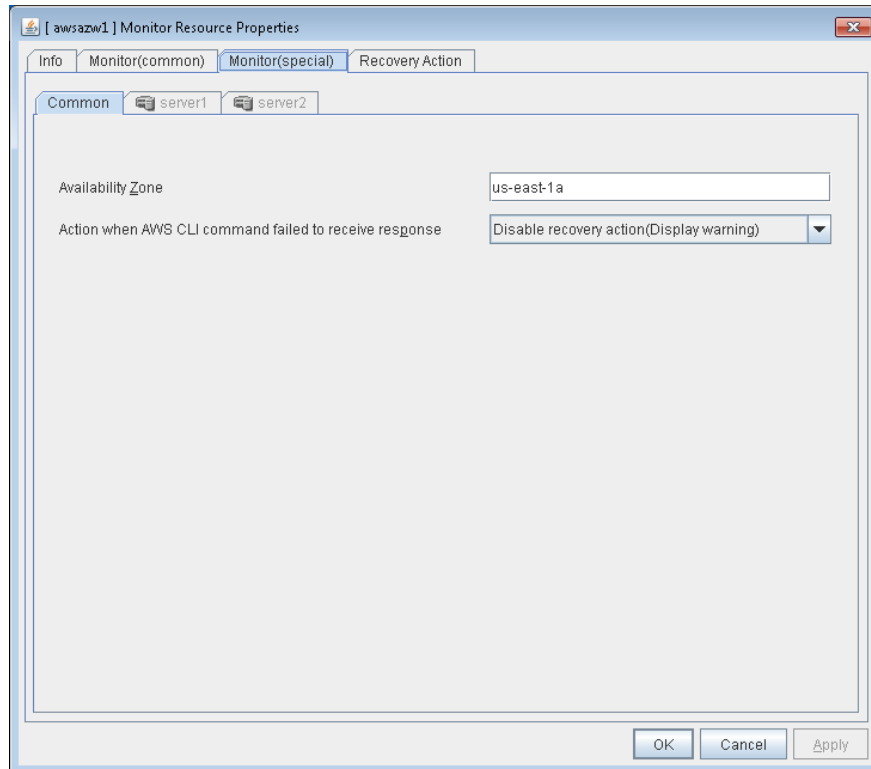

Availability Zone (Within 45 bytes) ~~SuspendResume~~

Specify the availability zone in which to perform monitoring.

Action when AWS CLI command failed to receive response ~~SuspendResume~~

Specify the action to be taken when acquiring the AWS CLI command response fails.

Displaying the AWS AZ monitor resource properties with the WebManager

1. Start the WebManager. (http://Management IP address or the IP address of the cluster server: port_number (the default value is 29003))
2. When you click an AWS AZ monitor object  in the tree view, the following information is displayed in the list view.

AWS AZ monitor: awsazw1		Details	
Common		server1	server2
Properties	Value		
Comment			
Availability Zone	us-east-1a		
Action when AWS CLI comma...	Disable recovery action(Display warning)		
Status	Normal		
Resource Status on Each Server			
Server Name	Status		
server1	Normal		
server2	Normal		

Comment: AWS AZ monitor resource comment

Status: Status of the AWS AZ monitor resource
 Availability Zone Availability zone
 Action when AWS CLI command failed to receive response
 Action to be taken when acquiring the AWS CLI command response fails.

Resource Status on Each Server
 Server Name: Server name of each server
 Status: Status of the monitor resource on the given server

When you click **Details**, the following information is displayed in the pop-up dialog box.

Properties	Value
Name	awsazw1
Type	awsazw
Monitor Timing	Always
Target Resource	
Interval	60
Timeout	100
Do Not Retry at Timeout Occurrence	Off
Do Not Execute Recovery Action at Timeout Occurrence	Off
Retry Count	1
Final Action	No operation
Execute Script Before Reactivation	Off
Execute Script Before Failover	Off
Execute Script before Final Action	Off
Recovery Target	LocalServer
Recovery Target Type	Itself
Recovery Script Threshold	0
Reactivation Threshold	0
Failover Target Server	Stable Server
Failover Threshold	0
Wait Time to Start Monitoring	0
Dummy Failure Possibility	Impossible
Collect Dump at Timeout Occurrence	Off
Run Migration Before Run Failover	Off

Name: AWS AZ monitor resource name
 Type: Monitor resource type
 Monitor Timing: Timing for the monitor resource to start monitoring
 Target Resource: Resource to be monitored
 Interval (sec) Interval between monitoring (in seconds)
 Timeout (sec) Timeout for monitoring (in seconds)
 Do Not Retry at Timeout Occurrence: Whether or not to retry when timeout occurs
 Do Not Execute Recovery Action at Timeout Occurrence: Whether or not to execute recovery action when timeout occurs
 Retry Count The number of retries to be made from detection of an error in the monitor target to establish the monitor resource as error
 Final Action Final action at detection of an error
 Execute Script before Reactivation Whether or not pre-reactivation script is executed upon the detection of an error
 Execute Script before Failover: Whether or not the pre-failover script is executed upon the detection of an error
 Execute Script before Final Action Whether or not the pre-final action script is executed upon the detection of an error
 Recovery Target: Target to be recovered when an error is detected
 Recovery Target Type: Type of target to be recovered when an error is detected
 Recovery Script Threshold: The number of times the recovery script is executed upon the detection of an error
 Reactivation Threshold: The number of reactivations to be made at detection of an error
 Failover Target Server: Determination method of Failover Target Server

Failover Threshold: The number of failovers to be made at detection of an error

Wait Time to Start Monitoring (sec): Time to wait before starting monitoring (in seconds)

Dummy Failure Possibility: Possibility of Dummy Failure

Collect Dump at Timeout Occurrence: Whether or not dump of monitor process is collected when timeout occurs

Run Migration Before Run Failover: Whether or not migration is run before running failover

Understanding Azure probe port monitor resources

Azure probe port monitor resources perform alive monitoring on a probe port control process that starts when Azure probe port resources are active on the node on which the Azure probe port resources are active. If the process does not start normally, a monitoring error occurs.

Notes on Azure probe port monitor resources

- ◆ Azure probe port resources are automatically created when Azure probe port resources are added. One Azure probe port monitor resource is automatically created per Azure probe port resource.
- ◆ In Azure probe port monitor resources, I will monitor the occurrence of probe standby timeout on the Azure probe port resources. Therefore, **Interval** of Azure probe port monitor resource, than the value of the set in the Azure probe port resources monitored **Probe Wait Timeout**, you need to set a large value.
- ◆ See “Setting up Azure probe port resources” on “Notes when creating the cluster configuration data” in Chapter 5, “Notes and Restrictions” of the *Getting Started Guide*.

Displaying and changing the Azure probe port monitor resource details

1. In the tree view shown on the left pane of the Builder, click the **Monitors** icon.
2. A list of monitor resources is shown in the table view on the right side of the screen. Right-click the desired Azure probe port monitor resource name. Then click **Properties** and select the **Monitor(special)** tab.
3. On the **Monitor(special)** tab, you can display and/or change the settings by following the description below.

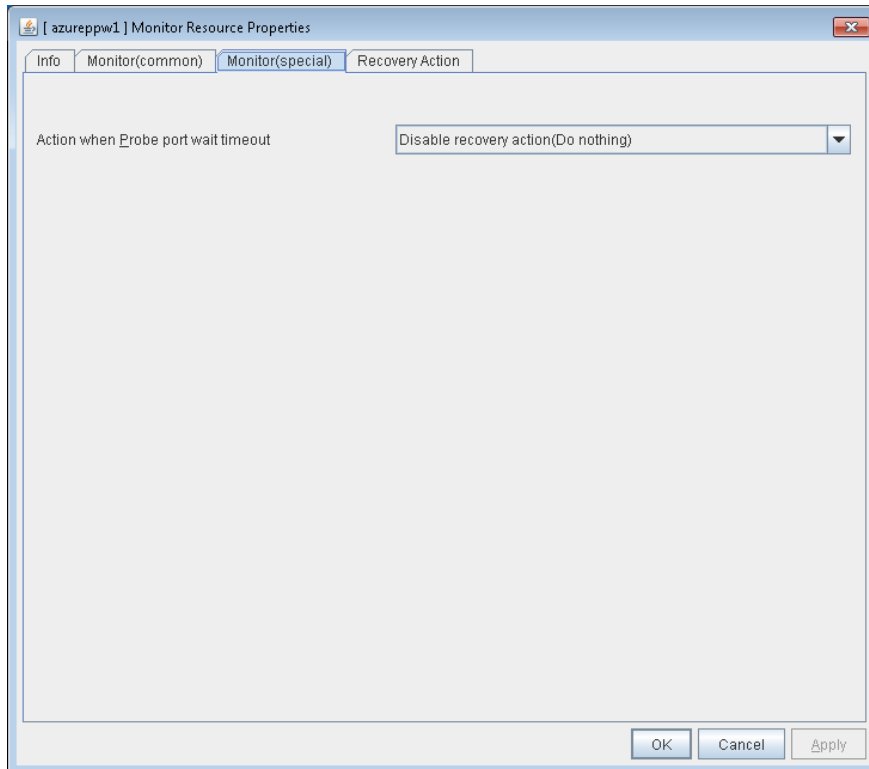

Action when Probe port wait timeout `SuspendResume`

Specify the recovery action to be taken when a probe port wait timeout occurs in Azure probe port resources.

Displaying the Azure probe port monitor resource properties with the WebManager

1. Start the WebManager. (http://Management IP address or the IP address of the cluster server: port_number (the default value is 29003))
2. When you click an Azure probe port monitor object  in the tree view, the following information is displayed in the list view.

Azure probe port monitor: azureppw1		Details	
Common		server1	server2
Properties	Value		
Comment			
Action when Probe port wait tim...	Disable recovery action(Do nothing)		
Status	Normal		
Resource Status on Each Server			
Server Name	Status		
server1	Offline		
server2	Offline		

Comment: Azure probe port monitor resource comment
 Status: Status of the Azure probe port monitor resource
 Action when Probe port wait timeout: Action to be taken when a timeout occurs.

Resource Status on Each Server:

Server Name: Server name of each server
 Status: Status of the monitor resource on the given server

When you click Details, the following information is displayed in the pop-up dialog box.

Properties	Value
Name	azureppw1
Type	azureppw
Monitor Timing	Activating
Target Resource	azurepp1
Interval	60
Timeout	100
Do Not Retry at Timeout Occurrence	Off
Do Not Execute Recovery Action at Timeout Occurrence	Off
Retry Count	1
Final Action	No operation
Execute Script Before Reactivation	Off
Execute Script Before Failover	Off
Execute Script before Final Action	Off
Recovery Target	azurepp1
Recovery Target Type	Resource
Recovery Script Threshold	0
Reactivation Threshold	3
Failover Target Server	Maximum Priority Server
Failover Threshold	Number of Servers
Wait Time to Start Monitoring	0
Dummy Failure Possibility	Impossible
Collect Dump at Timeout Occurrence	Off
Run Migration Before Run Failover	Off

Name: Azure probe port monitor resource name
 Type: Monitor resource type
 Monitor Timing: Timing for the monitor resource to start monitoring
 Target Resource: Resource to be monitored
 Interval (sec): Interval between monitoring (in seconds)
 Timeout (sec): Timeout for monitoring (in seconds)
 Do Not Retry at Timeout Occurrence: Whether or not to retry when timeout occurs
 Do Not Execute Recovery Action at Timeout Occurrence: Whether or not to execute recovery action when timeout occurs
 Retry Count: The number of retries to be made from detection of an error in the monitor target to establish the monitor resource as error
 Final Action: Final action at detection of an error
 Execute Script before Reactivation: Whether or not pre-reactivation script is executed upon the detection of an error
 Execute Script before Failover: Whether or not the pre-failover script is executed upon the detection of an error
 Execute Script before Final Action: Whether or not the pre-final action script is executed upon the detection of an error
 Recovery Target: Target to be recovered when an error is detected
 Recovery Target Type: Type of target to be recovered when an error is detected
 Recovery Script Threshold: The number of times the recovery script is executed upon the detection of an error
 Reactivation Threshold: The number of reactivations to be made at detection of an error
 Failover Target Server: Determination method of Failover Target Server
 Failover Threshold: The number of failovers to be made at detection of an error
 Wait Time to Start Monitoring (sec): Time to wait before starting monitoring (in seconds)
 Dummy Failure Possibility: Possibility of Dummy Failure

Collect Dump at Timeout Occurrence:	Whether or not dump of monitor process is collected when timeout occurs
Run Migration before Run Failover	Whether or not migration is run before running failover

Understanding Azure load balance monitor resources

Azure load balance monitor resources monitor to see if a port with the same port number as that of the probe port has been open on the node on which the Azure probe port resources are not active.

Notes on Azure load balance monitor resources

- ◆ Azure load balance monitor resources are automatically created when Azure probe port resources are added. One Azure load balance monitor resource is automatically created per Azure probe port resource.
- ◆ See “Setting up Azure probe port resources” on “Notes when creating the cluster configuration data” in Chapter 5, “Notes and Restrictions” of the *Getting Started Guide*.
- ◆ See “Setting up Azure load balance monitor resources” on “Notes when creating the cluster configuration data” in Chapter 5, “Notes and Restrictions” of the *Getting Started Guide*.

Displaying and changing the Azure load balance monitor resource details

1. In the tree view shown on the left pane of the Builder, click the **Monitors** icon.
2. The list of monitor resources list is shown in the table view on the right side of the screen. Right-click the desired Azure load balance monitor resource name. Then click **Properties** and select the **Monitor(special)** tab.
3. On the **Monitor(special)** tab, you can display and/or change the settings by following the description below.

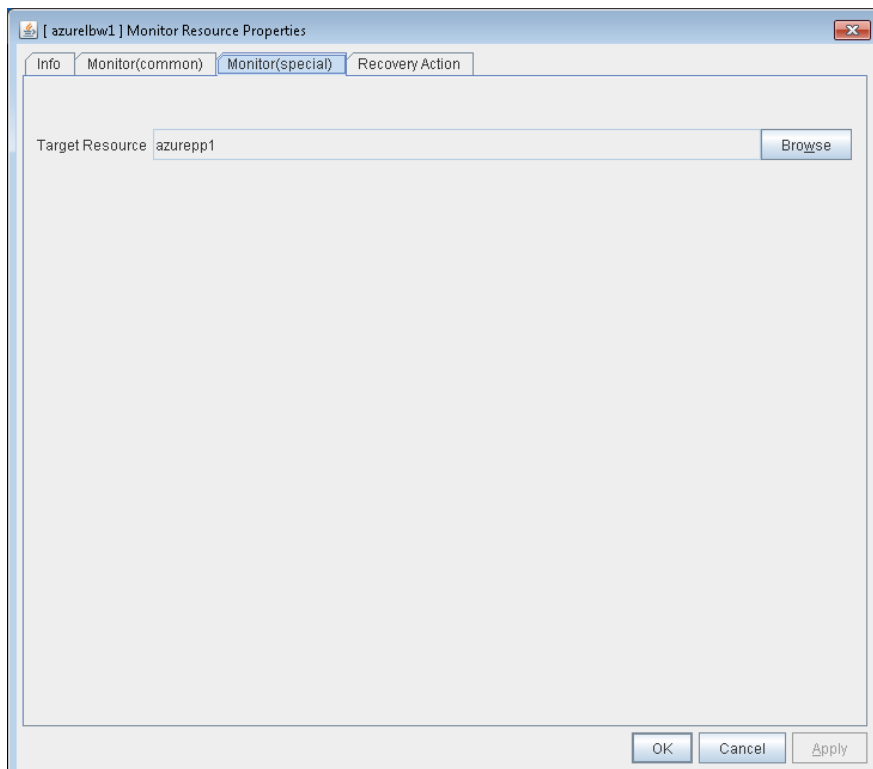

Target Resource **SuspendResume**

Set Resource to be monitored

Displaying Azure load balance monitor resource properties with the WebManager

1. Start the WebManager. (http://Management IP address or the IP address of the cluster server:port_number (the default value is 29003))
2. When you click an Azure load balance monitor object  in the tree view, the following information is displayed in the list view.

Azure load balance monitor: azurelbw1		Details
<div style="display: flex; border-bottom: 1px solid gray;"> Common server1 server2 </div>		
Properties	Value	
Comment		
Monitor Target	azurepp1	
Status	Normal	
Resource Status on Each Server		
Server Name	Status	
server1	Normal	
server2	Normal	

Comment: Azure load balance monitor resource comment
 Status: Status of the Azure load balance monitor resource
 Monitor Target: Resource to be monitored

Resource Status on Each Server
 Server Name: Server name of each server
 Status: Status of the monitor resource on the given server

When you click **Details**, the following information is displayed in the pop-up dialog box.

Properties	Value
Name	azurelbw1
Type	azurelbw
Monitor Timing	Always
Target Resource	
Interval	60
Timeout	100
Do Not Retry at Timeout Occurrence	Off
Do Not Execute Recovery Action at Timeout Occurrence	Off
Retry Count	1
Final Action	No operation
Execute Script Before Reactivation	Off
Execute Script Before Failover	Off
Execute Script before Final Action	Off
Recovery Target	azurepp1
Recovery Target Type	Resource
Recovery Script Threshold	0
Reactivation Threshold	3
Failover Target Server	Maximum Priority Server
Failover Threshold	Number of Servers
Wait Time to Start Monitoring	0
Dummy Failure Possibility	Impossible
Collect Dump at Timeout Occurrence	Off
Run Migration Before Run Failover	Off

Name:	Azure load balance monitor resource name
Type:	Monitor resource type
Monitor Timing:	Timing for the monitor resource to start monitoring
Target Resource:	Resource to be monitored
Interval (sec):	Interval between monitoring (in seconds)
Timeout (sec):	Timeout for monitoring (in seconds)
Do Not Retry at Timeout Occurrence:	Whether or not to retry when timeout occurs
Do Not Execute Recovery Action at Timeout Occurrence:	Whether or not to execute recovery action when timeout occurs
Retry Count	The number of retries to be made from detection of an error in the monitor target to establish the monitor resource as error
Final Action	Final action at detection of an error
Execute Script before Reactivation	Whether or not pre-reactivation script is executed upon the detection of an error
Execute Script before Failover	Whether or not the pre-failover script is executed upon the detection of an error
Execute Script before Final Action	Whether the pre-final action script is executed upon the detection of an error
Recovery Target	Target to be recovered when an error is detected
Recovery Target Type	Type of target to be recovered when an error is detected
Recovery Script Threshold	The number of times the recovery script is executed upon the detection of an error
Reactivation Threshold:	The number of reactivations to be made at detection of an error
Failover Target Server:	Determination method of Failover Target Server
Failover Threshold:	The number of failovers to be made at detection of an error
Wait Time to Start Monitoring (sec)	Time to wait before starting monitoring (in seconds)
Dummy Failure Possibility	Possibility of Dummy Failure
Collect Dump at Timeout Occurrence	Whether or not dump of monitor process is collected when timeout occurs
Run Migration Before Run Failover	Whether or not migration is run before running failover

Chapter 7 Heartbeat resources

This chapter provides detailed information on heartbeat resources.

This chapter covers:

- Heartbeat resources 1060
- Understanding kernel mode LAN heartbeat resources 1061
- Understanding BMC heartbeat resources 1063

Heartbeat resources

Servers in a cluster monitor if other servers in the cluster are activated. For this monitoring, heartbeat resources are used.

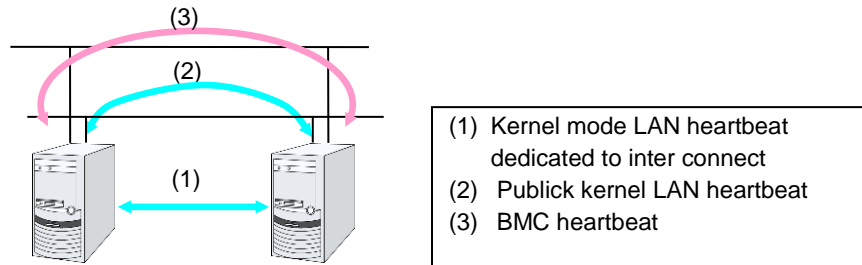

Type of Heartbeat resource	Abbreviation	Functional overview
Kernel mode LAN heartbeat resource (1), (2)	lankhb	A kernel mode module uses a LAN to monitor if servers are activated.
BMC heartbeat resource (3)	bmchb	Monitors if servers are activated by using BMC.

- You need to set at least one LAN heartbeat resource. It is recommended to set two or more LAN heartbeat resources. It is recommended to set both interconnect-dedicated LAN heartbeat resource and public LAN heartbeat resource together.
- Make sure to set one or more Kernel mode LAN heartbeats that can communicate among all the servers.

Understanding kernel mode LAN heartbeat resources

Kernel mode LAN heartbeat resources

Kernel mode LAN heartbeat resources achieve heartbeat functions using the kernel mode driver module. Kernel mode LAN heartbeat resources are less burdened and help to reduce misidentification of disconnection of interconnect by using the kernel mode driver.

Settings of the kernel mode LAN heartbeat resources

For details on settings of the kernel mode LAN heartbeat resources, see “Cluster properties Interconnect tab” in Chapter 2, “Function of the Builder” in this guide.

Notes on the kernel mode LAN heartbeat resources

- It is recommended to specify two or more kernel mode LAN heartbeat resources; the one dedicated to interconnect and the one shared with interconnect and public.
- The communication data of alert synchronization is transmitted over the interconnect interface. You should consider network traffic when you make settings.
- You can set the same IP address to the interconnect LAN interface and the public LAN interface. If you do this, communication data of alert synchronization is transmitted.

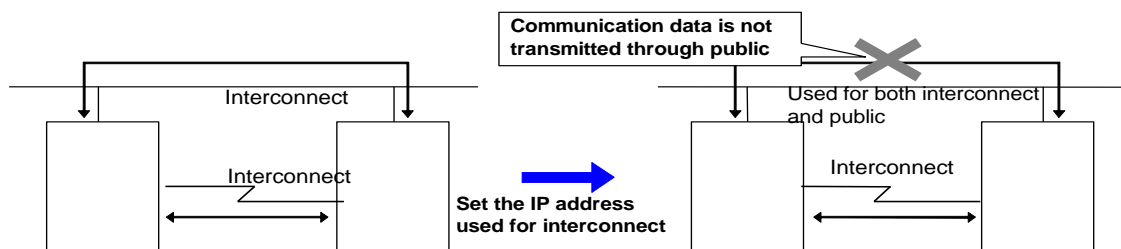

Displaying the properties of kernel mode LAN heartbeat resources with the WebManager

1. Start the WebManager (*http://Management IP address or the IP address of the cluster server: port_number* (the default value is 29003)).
2. Click the kernel mode LAN heartbeat resources object, , in the tree view. The following information is displayed in the list view.

Kernel Mode LAN Heartbeat Name: lankhb1		Details
Server Name	Status	
server1	Normal	
server2	Normal	

Server Name: Server name
 Status: Status of the heartbeat resource on the given server

When you click **Details**, the following information is displayed in the pop-up dialog box.

Properties	Value
Name	lankhb1
Type	lankhb
Comment	LAN Heartbeat
Status	Normal
IP Address	10.0.0.1

Name: Kernel mode LAN heartbeat resource name
 Type: Kernel mode LAN heartbeat resource type
 Comment: Comment of the Kernel mode LAN heartbeat resource
 Status: Status of all kernel mode LAN heartbeat resources
 IP Address: IP address of the LAN used for kernel mode LAN heartbeat

Understanding BMC heartbeat resources

Notes on BMC heartbeat resources

BMC heartbeat resources provide the same functions as LAN heartbeat resources using the BMC. They have the following features:

- ◆ BMC heartbeat resources are less burdened and help to reduce the misidentification of any disconnection of an interconnect by using hardware to monitor whether the server is active.
- ◆ The versions of the BMC hardware and firmware must be available for BMC heartbeat resources. For the available BMC versions, refer to "Servers supporting Express5800/A1080a or Express5800/A1040a series linkage" in Chapter 3, "Installation requirements for EXPRESSCLUSTER" in the *Getting Started Guide*.

Displaying the properties of BMC heartbeat resources with the WebManager

1. Start the WebManager.
2. Click the BMC heartbeat resources object, , in the tree view. The following information is displayed in the list view.

BMC Heartbeat: bmchb1		Details
Server Name	Status	
server1	Normal	
server2	Normal	

Server Name: Server name
 Status: Status of the heartbeat resource on the given server

When you click **Details**, the following information is displayed in the pop-up dialog box.

Properties	Value
Name	bmchb1
Type	bmchb
Comment	BMC Heartbeat
Status	Normal
IP Address	192.168.12.176

Name: BMC heartbeat resource name
 Type: BMC heartbeat resource type
 Comment: Comment for the BMC heartbeat resource
 Status: Status of all BMC heartbeat resources
 IP Address: IP address of the BMC used for the BMC heartbeat resource

Chapter 8 Details on network partition resolution resources

This chapter provides detailed information on network partition resolution resources.

This chapter covers:

- Network partitions 1066
- Understanding the network partition resolution resources 1066
- Understanding network partition resolution by COM method 1069
- Understanding network partition resolution by DISK method 1071
- Understanding network partition resolution by PING method 1074
- Understanding network partition resolution by majority method 1076
- Understanding network partition resolution by COM method and DISK method 1078
- Understanding network partition resolution by PING method and DISK method 1078
- Not resolving network partition 1078
- Notes on network partition resolution resource settings 1079

Network partitions

Network partitioning, or “Split Brain” syndrome, refers to the status where all communication channels have problems and the network between servers is partitioned.

In a cluster system that is not equipped with solutions for “Split Brain Syndrome,” a failure on a communication channel cannot be distinguished from an error on a server. This can cause data corruption brought by access from multiple servers to the same resource. EXPRESSCLUSTER, on the other hand, uses resources for network partition resolution to distinguish a failure on a server from “Split Brain Syndrome” when a heartbeat from a server is lost. If the lack of heartbeat is determined to be caused by the server’s failing, the system performs a failover by activating each resource and rebooting applications on a server running normally. When the lack of heartbeat is determined to be caused by “Split Brain” syndrome, the selected “action at NP occurrence”⁷ is executed because protecting data has higher priority over continuity of the operation.

Understanding the network partition resolution resources

Servers in a cluster monitor other servers by using heartbeat resources. When all heartbeat resources are disconnected or other server is shut down by a server not in a cluster, the network partition is solved using network partition resolution resources. The following four types of network partition resolution resources are provided.

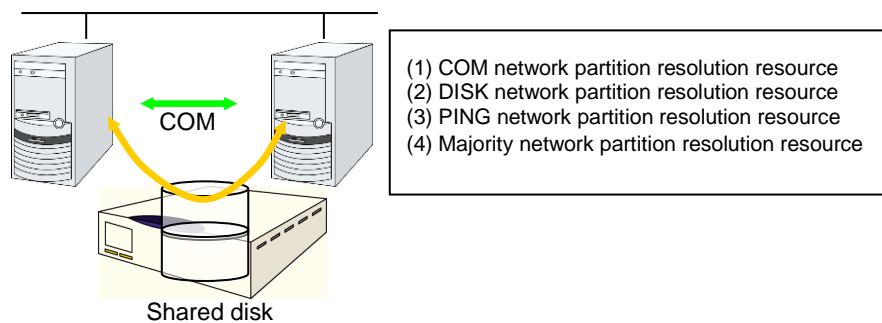

Network partition resolution resources	Abbreviation	Function Overview
COM network partition resolution resource (COM method)	comnp	A network partition is solved by connecting two servers with COM cable.
DISK network partition resolution resource (DISK method)	Disk1np	A network partition is solved by using a dedicated disk partition on the shared disk.
PING network partition resolution resource (PING method)	pingnp	A network partition is solved by determining a server that can communicate using the ping command.
Majority network partition resolution resource (Majority method)	majonp	A network partition is solved by the number of servers that can make connection among three or more servers.

⁷ The action can be changed on Builder by selecting **Cluster Properties->NP Resolution** tab->**Tuning** button->**Network Partition Resolution Tuning Properties** window->**Action at NP Occurrence**.
EXPRESSCLUSTER X 3.3 for Windows Reference Guide

A network partition resolution resource that can be selected is different depending on a server configuration in a cluster. Select one of the following network partition resolution methods:

Cluster server configuration	Network partition resolution method (Listed in the order of our recommendation)
Mirror disk resource exists	<p>Number of servers: 2</p> <ul style="list-style-type: none"> - PING method and DISK method - COM method and DISK method - DISK method <p>Number of servers: 3 or more servers</p> <ul style="list-style-type: none"> - PING method and DISK method - DISK method - Majority method
Mirror disk resource exists but disk resource does not exist	<p>Number of servers: 2</p> <ul style="list-style-type: none"> - PING method - COM method - No network partition resolution <p>Number of servers: 3 or more servers</p> <ul style="list-style-type: none"> - PING method - Majority method - No network partition resolution
Neither disk resource nor mirror disk resource does not exist	<p>Number of servers: 2</p> <ul style="list-style-type: none"> - PING method - COM method - No network partition resolution <p>Number of servers: 3 or more servers</p> <ul style="list-style-type: none"> - PING method - Majority method - No network partition resolution

- For example, if both server1 and server2 use disk resource and mirror disk resource, the combination of DISK method and PING method, or a DISK method can be selected as a network partition resolution resource.

Disk resource and mirror disk resource

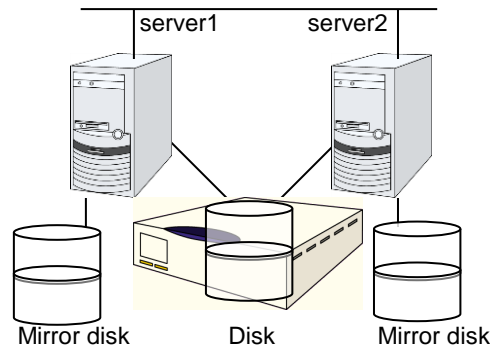

- When servers that can be started by disk resource and mirror disk resource differ, the network partition resolution resource needs to be set in each server. For example, if server1 and server2 use a shared disk, and server2 and server3 use a mirror disk, the combination of COM method and DISK method, PING method and DISK method, DISK method can be selected as network partition resolution resource for server1 and server2. PING method or COM method can be selected for server2 and server3.

Disk resource Mirror disk resource

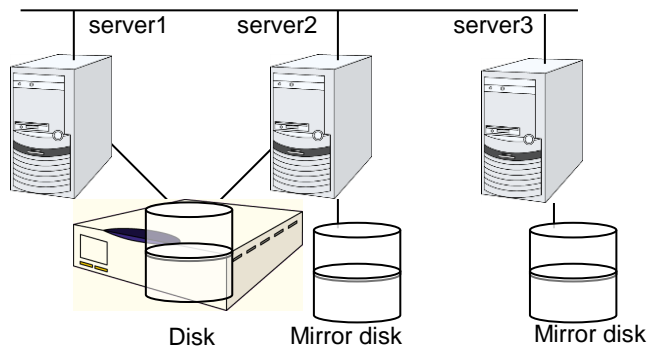

- A combination of two or more types of network partition resolution resources can be registered. When two or more types of resources are registered, they are used for solving an NP in the following order:
 1. PING method and DISK method
 2. COM method and DISK method
 3. PING method
 4. COM method
 5. DISK method
 6. Majority method

Understanding network partition resolution by COM method

Settings of the COM network partition resolution resources

To use COM network partition resolution resources, prepare a serial cross cable to connect two servers.

- The COM network partition resolution resources shut down a server with less priority when a network partition is detected.

The COM network partition resolution resources executes the selected “action at NP occurrence” in the server with less priority when a network partition is detected.

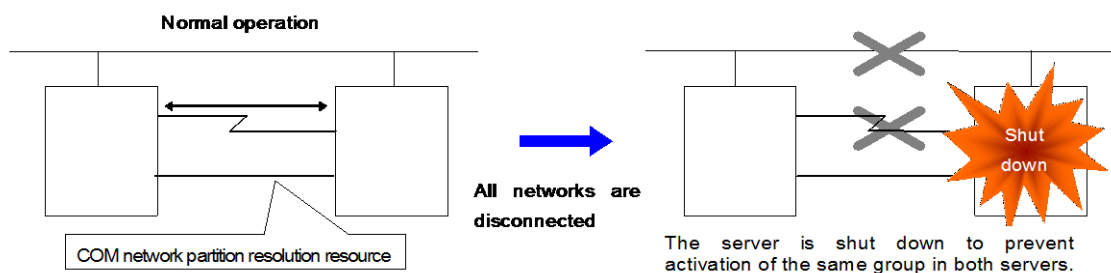

For more information, refer to “Cluster properties NP Resolution tab” in Chapter 2, “Function of the Builder” in this guide.

COM network partition resolution resources

- COM network partition resolution resource can be used between two servers. When mirror disk resources are used, be sure not to use COM network partition resolution resource.
- The selected “action at NP occurrence” takes places in all servers if all heartbeats are disconnected while the COM channel is having an error (for example COM port or serial cross cable.)
- If failures occur in all network channels between cluster servers and the COM channel simultaneously, both active and standby servers fail over. This can cause data corruption due to access to the same resource from multiple servers.

Displaying the properties of COM network partition resolution resources with the WebManager

1. Start the WebManager (*http://Management IP address or the IP address of the cluster server: port_number* (the default value is 29003)).
2. Click the COM network partition resolution resource object, , in the tree view. The following information is displayed in the list view.

COM Network Partition Resolution Resource Name: comnp1		Details
Server Name	Status	
server1	Normal	
server2	Normal	

Server Name: Server name
 Status: Status of the network partition resource on the given server

When you click **Details**, the following information is displayed in the pop-up dialog box.

Properties	Value
Name	comnp1
Type	comnp
Comment	com resolution
Status	Normal
Port Name	COM1

Name: COM network partition resolution resource name
 Type: COM network partition resolution resource type
 Comment: Comment of the COM network partition resolution resource
 Status: Status of all COM network partition resolution resources
 Port Name: Port name used for COM network partition resolution

Understanding network partition resolution by DISK method

Settings of the DISK network partition resolution resources

The following settings are required to use DISK network partition resolution resource:

- Allocate a dedicated disk partition for disk heartbeat resource on the shared disk. It is not necessary to format the partition.
- Allocate driver letters for the disk partition on the shared disk. The drive letters must be the same for all the servers.

DISK network partition resolution resources cause the “action at NP occurrence” in servers that cannot communicate with the first priority server or the cluster service to stop when a network partition is detected.

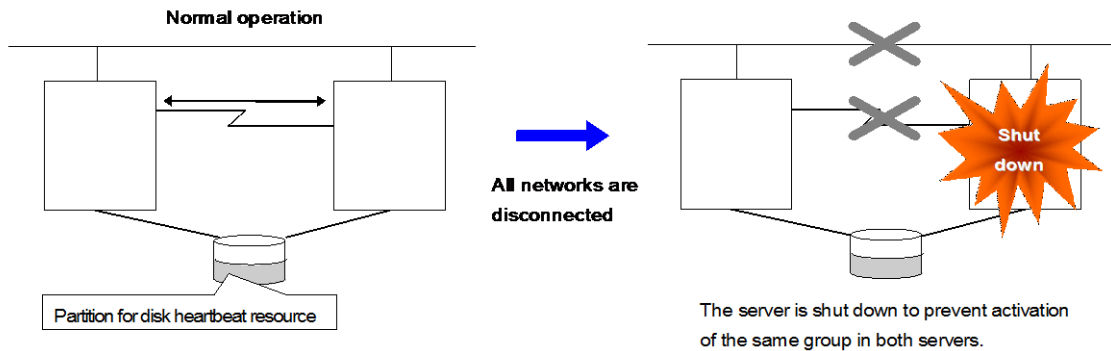

When a cluster is configured with two or more servers, DISK network partition resolution resources can be used as described below. DISK network partition resolution resources can be set to be used by servers that use the shared disk in a cluster.

For more information, refer to “Cluster properties NP Resolution tab” in Chapter 2, “Function of the Builder” in this guide.

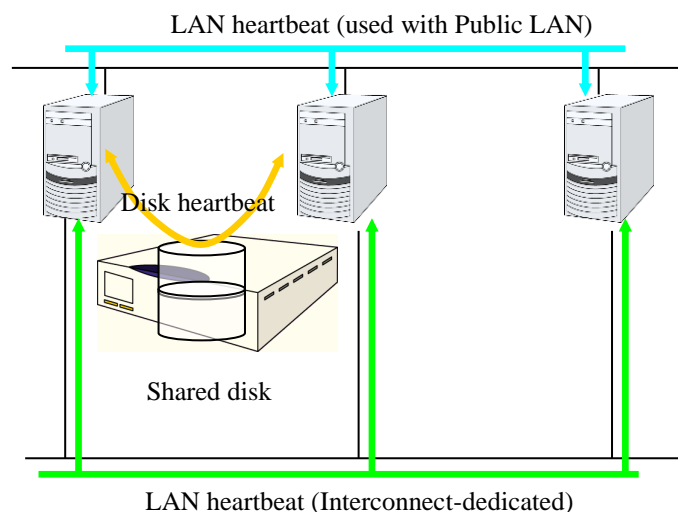

DISK network partition resolution resources

- It is recommended to use DISK network partition resolution resources when a shared disk is used.
- Configure DISK network partition resolution resources considering burden on the disk because they regularly perform read/write operations to the disk.
- For disk heartbeat partitions to be used in DISK network partition resolution resources, use partitions that are configured to be managed in cluster in the HBA settings.
- If a failure has occurred on all network channels while all disk heartbeat partitions can be accessed normally, a network partition is detected. Then failover takes place in the master server and a server that can communicate with the master server. The selected “action at NP occurrence” takes place in the rest of servers.
- If the heartbeat is lost while some disk heartbeat partitions cannot be accessed normally, the network partitions cannot be solved and a failover cannot be performed. In this case, the selected “action at NP occurrence” is performed for those servers for which the disk heartbeat partition cannot be accessed normally.
- When the I/O time to the shared disk takes longer than I/O Wait Time of DiskNP resource configured in cluster properties, a failover may not be performed due to timeout of solving a network partition.
- Solving a network partition with this method takes longer compared to other methods because delay in disk I/O needs to be taken into account. The time required to solve a network partition takes twice as long as the longer time of the heartbeat timeout and Disk I/O Wait Time configured in cluster properties.
- When DISK network partition resolution resources are used, all servers on which a cluster is started periodically access the dedicated disk partition on the shared disk. The servers on which the cluster is stopped or suspended do not access the dedicated partition.

Displaying the properties of DISK network partition resolution resources with the WebManager

1. Start the WebManager (*http://Management IP address or the IP address of the cluster server: port_number* (the default value is 29003)).
2. Click the DISK network partition resolution resource object, , in the tree view. The following information is displayed in the list view.

DISK Network Partition Resolution Resource Name: disknp1		Details
Server Name	Status	
server1	Normal	
server2	Normal	

Server Name: Server name
 Status: Status of the network partition resource on the given server

When you click **Details**, the following information is displayed in the pop-up dialog box.

Properties	Value
Name	disknp1
Type	disknp
Comment	disk resolution
Status	Normal
Volume Mount Point	W:\
Disk I/O Wait Time	80

Name: DISK network partition resolution resource name
 Type: DISK network partition resolution resource type
 Comment: Comment of the DISK network partition resolution resource
 Status: Status of all DISK network partition resolution resources
 Volume Mount Point: Drive letters of disk heartbeat partition
 Disk I/O Wait Time: Read/Write wait time for DISK network partition resolution

Understanding network partition resolution by PING method

Settings of the PING network partition resolution resources

To use PING network partition resolution resources, a device that is always active to receive and respond to the ping command (hereafter described as ping device) is required.

When the heartbeat from another server is lost but the ping device is responding to the ping command, the remote server is down. Failover starts. If there is no response to the ping command, it is determined that the local server is isolated from the network due to “Split Brain Syndrome,” and the selected “action at NP occurrence” takes place.

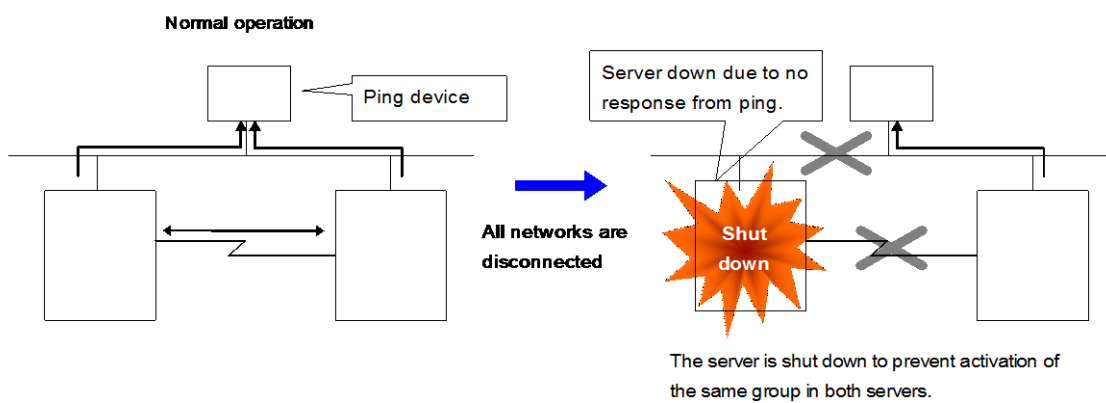

For more information, refer to “Cluster properties NP Resolution tab” in Chapter 2, “Function of the Builder” in this guide.

PING network partition resolution resource

To use the ping network partition resolution resource, specify an address that allows transmission and reception via the interconnect LAN registered in the configuration data.

When the status where no response is returned to the ping command on all servers continues before the heartbeat is lost, which is caused by a failure in the ping device, if a network partition occurs under such situation, “action at NP occurrence” is not executed.

When shared disk is used, it is recommended to use not only PING Network Partition Resolution resource, but also DISK Network Partition Resolution resource at the same time.

It is possible to set **Use** or **Do Not Use** for each server. If **Do Not Use** is set incorrectly, NP resolution processing cannot be performed and a double activation may be detected. The following is an example of an incorrect setting in which NP resolution processing cannot be performed.

NP Resolution List				
Type	Ping Target	server1	server2	
Ping	10.0.0.254	Use	Do Not Use	
Ping	10.0.0.254	Do Not Use	Use	

Displaying the properties of PING network partition resolution resources with the WebManager

1. Start the WebManager (*http://Management IP address or the IP address of the cluster server: port_number* (the default value is 29003)).
2. Click the PING network partition resolution resource object, , in the tree view. The following information is displayed in the list view.

PING Network Partition Resolution Resource Name: pingnp1		Details
Server Name	Status	
server1	Normal	
server2	Normal	

Server Name: Server name
 Status: Status of the network partition resource on the given server

When you click **Details**, the following information is displayed in the pop-up dialog box.

Properties	Value
Name	pingnp1
Type	pingnp
Comment	ping resolution
Status	Normal
IP Addresses	192.168.0.254
Ping Interval	5
Ping Timeout	3
Ping Retry Threshold	3

Name: PING network partition resolution resource name
 Type: PING network partition resolution resource type
 Comment: Comment of the PING network partition resolution resource
 Status: Status of all PING network partition resolution resources
 IP Addresses: List of IP addresses of the ping device
 Ping Interval: Interval for PING network partition resolution resource
 Ping Timeout: Timeout for PING network partition resolution resource
 Ping Retry Threshold: Threshold value for retrying PING network partition resolution resource

Understanding network partition resolution by majority method

Settings of the majority network partition resolution resources

This method prevents data corruption caused by “Split Brain Syndrome” by executes the selected “action at NP occurrence” in the server that can no longer communicate with the majority of the servers in the entire cluster because of network failure or stopping the cluster service.

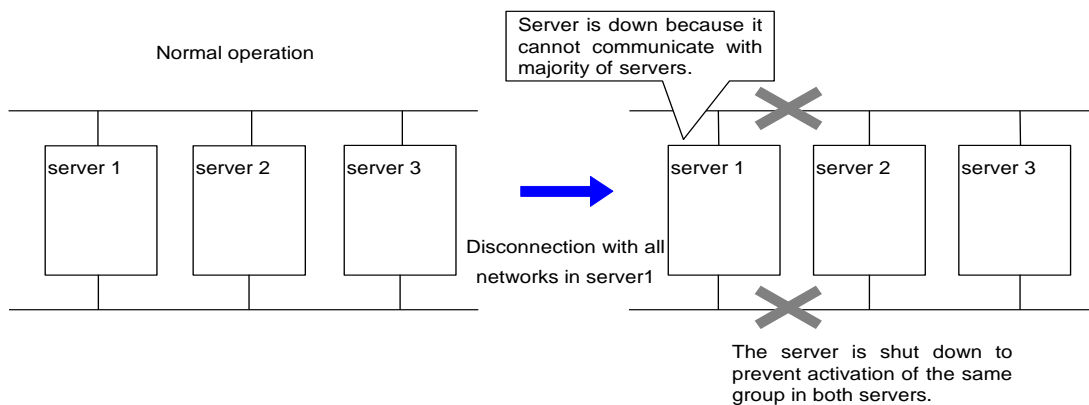

For more information, refer to “Cluster properties NP Resolution tab” in Chapter 2, “Function of the Builder” in this guide.

Majority network partition resolution resources

- This method can be used in a cluster with three or more nodes.
- If majority of the servers are down, the selected “action at NP occurrence” takes place in rest of the servers working properly. When communication with exactly half of the servers in the entire cluster is failing, the selected “action at NP occurrence” takes place in a server that cannot communicate with the top priority server.
- If all servers are isolated form the network due to a hub error, the selected “action at NP occurrence” takes place in all servers.

Displaying the properties of majority network partition resolution resources with the WebManager

1. Start the WebManager (*http://Management IP address or the IP address of the cluster server: port_number* (the default value is 29003)).
2. Click the majority network partition resolution resource object, , in the tree view. The following information is displayed in the list view.

Majority Network Partition Resolution Resource Name: majonp1		Details
Server Name	Status	
server1	Normal	
server2	Normal	

Server Name: Server name
 Status: Status of the network partition resource on the given server

When you click **Details**, the following information is displayed in the pop-up dialog box.

Properties	Value
Name	majonp1
Type	majonp
Comment	majo resolution
Status	Normal

Name: Majority network partition resolution resource name
 Type: Majority network partition resolution resource type
 Comment: Comment of the majority network partition resolution resource
 Status: Status of all majority network partition resolution resources

Understanding network partition resolution by COM method and DISK method

A network partition is solved by combining COM network partition resolution resources and DISK network partition resolution resources.

When the COM channel (such as a COM port and serial cross cable) is working properly, this method works in the same way as the COM method. When an error occurs on the COM channel, this method switches to the shared disk method. This mechanism allows for higher availability than using only the COM method. The method also resolves achieves network partition faster than using the disk method alone.

Understanding network partition resolution by PING method and DISK method

A network partition is solved by combining PING network partition resolution resources and DISK network partition resolution resources.

When communication with ping device is working properly, this method works in the same way as the PING method. Whereas, when the communication is not working properly⁸, this method works in the same way as the DISK method. This mechanism allows for higher availability than using the PING method alone. The method also solves network partition faster than using only the disk method.

This method works as PING + DISK method when the server which uses PING network partition resolution resources and the server which uses DISK network partition resolution resources are identical. For example, in the clusters of hybrid disk configuration, when DISK network partition resolution resources used by a particular server group and PING network resolution resources used by the whole clusters are configured, these resources work independently. In such a case, to configure the resources to work in PING+DISK method, it is required to add PING network resolution resources to be used only by the same server group as DISK network partition resolution resources.

Not resolving network partition

- This method can be selected in a cluster that does not use a shared disk.
- If a failure occurs on all network channels between servers in a cluster, all servers failover.

⁸ Status where no response is returned to the ping command on all servers before the heartbeat is lost, which is caused by a failure in the ping device.

Notes on network partition resolution resource settings

In Ver. 2.1 or earlier, if any combination of network partition resolution resources other than those shown above is specified, network partitions are not resolved. In Ver. 3.0 or later, network partitions are resolved in the following order according to the specified resources, even for a combination of network partition resolution resources other than those shown above.

- (1) PING method and DISK method
- (2) COM method and DISK method
- (3) PING method (not applied if network partition resolution processing is performed in 1.)
- (4) COM method (not applied if network partition resolution processing is performed in 2.)
- (5) DISK method (not applied if network partition resolution processing is performed in 1 or 2.)
- (6) Majority method

Chapter 9 Other monitor settings

This chapter provides information on other monitor settings.

This chapter covers:

- The forced stop function..... 1082
- Script for forced stop..... 1085
- Chassis Identify 1087
- Alert Service..... 1089
- SNMP linkage 1093
- Express5800/A1080a or Express5800/A1040a series linkage 1099
- AWS elastic ip resources, AWS virtual ip resources, AWS elastic ip monitor resources, AWS virtual ip monitor resources, AWS AZ monitor resources..... 1108
- Azure probe port resources, Azure probe port monitor resources, Azure load balance monitor resources 1109

The forced stop function

What is the forced stop function?

The forced stop function forcibly stops the failing server from one of the rest of servers working normally when it is recognized that the server is failing.

This function stops a physical machine by using the IPMI function.

It stops the guest OS on a virtual machine by using the VMware vCenter Server or System Center Virtual Machine Manager (SCVMM) .

In addition to the functions above, you can execute a script in which the procedure for stopping the failing server is written. For details, refer to “Script for forced stop” in Chapter 9, “Other monitor settings” in this guide.

Conditions for performing forced stop

- ◆ Forcibly stopping the guest OS on a virtual machine
 - Only power off operation can be performed. This function cannot be used if communication with VMWare vCenter Server cannot be performed.
- ◆ Versions of ipmiutil
 - When you use the hwreset command or the iredset command, use ipmiutil 1.7.9-1 or later.
- Forced stop is not performed when:
 - The failover group successfully stops before the server fails
 - The server is shut down by the clpdown command, the OS shutdown command or WebManager and the failover group successfully stops
 - The cluster is stopped by the clpcl command or WebManager and the failover group successfully stops
 - The server fails and there is no failover group to perform failover from the failing server to another server
(including when the failover group is not activated in the failing server)
- Forced stop is performed when the server is failing and there is a failover group to perform failover from the failing server to another server

Commands to be used for forced stop

The `hwreset` or `ireset` command in IPMI Management Utilities (`ipmiutil`) is used to forcibly stop a physical machine server. When the command cannot be used, this function cannot be used either.

Specify the following option values for the command execution in the **BMC** tab of **Server Properties**.

The <code>hwreset</code> or <code>ireset</code> command option	Configured in the BMC tab of the server properties
-N [<i>target IP address</i>]	IP address
-U [<i>user name</i>]	User name
-P [<i>password</i>]	Password

The `vmcontrol` command of the VMware vSphere Command Line Interface (vCLI) is used to forcibly stop the guest OS on a virtual machine. This function cannot be used if VMware vSphere Command Line Interface (vCLI) is not installed.

Specify the following option values for the command execution.

<code>vmcontrol</code> command option	Configured in Virtual Machine Forcestop Setting on the Recovery tab of Cluster Properties	Configured in Input for Virtual Machine name on the Info tab of Server Properties
--server [<i>vCenter IP address</i>]	IP address	-
--username [<i>vCenter user name</i>]	User name	-
--password [<i>vCenter password</i>]	Password	-
--xxxxxx [<i>virtual machine name</i>]	-	Virtual machine name

The following option is used for action.

Command	Option	Overview
<code>vmcontrol</code>	--operation poweroff	Powers off the guest OS on a virtual machine.

Displaying and changing the details of forced stop

For the forced stop settings, refer to “Cluster properties Recovery tab”, “Servers Properties Info tab”, and “Servers Properties BMC tab” in Chapter 2 “Function of the Builder” in this guide.

Notes on the forced stop

- Forcibly stopping the guest OS on a virtual machine
Only power off operation can be performed. Moreover, this function cannot be used in the following cases:
- vSphere infrastructure: Communication with VMWare vCenter Server is not possible.
- About `ipmiutil`
When you use the `hwreset` or `ireset` command, it is necessary to install `ipmiutil` 2.0.0 or later in each cluster server. For information on how to get `ipmiutil` and how to install it, refer to “Settings after configuring hardware 9. Setup of BMC and `ipmiutil`” in Chapter 1 “Determining a system configuration” in the *Installation and Configuration Guide*.

- **Impacts on forced stop**
When you use the forced stop function, the following functions are influenced because power off, reset, power cycle or NMI is forcibly performed regardless of the OS or server status.
 - **Dump collection**
Because it is not recognized that dump files are being collected, power off, reset or power cycle is performed even though dump collection is being performed, so dump collection does not complete.
 - **Power on within heartbeat timeout**
When the server is powered on again for the purpose of maintenance etc. within heartbeat timeout, power off, reset, power cycle or NMI may occur after heartbeat timeout has elapsed.
- **BMC network settings**
Configure the settings so that the IP address of the LAN port for BMC management and the IP address which OS uses can communicate with each other. This function cannot be used when BMC is not installed in the server, or in the environment where the network for the BMC management is blocked.
Configure the same IP address that is configured for the LAN port for the BMC management to the BMC tab of the server properties.
See the server's manuals etc. for information on how to configure the IP address of the LAN port for the BMC management etc.
- **Power Options settings of the OS**
When power off or power cycle is executed by BMC or power off of the guest OS on a virtual machine is executed by VMware vSphere, operation specified in **Power Options** of the OS (e.g. sleep, hibernation and shutdown) may be executed.
The settings can be referred to and configured by the following instruction:

Windows Server 2003: Open **Power Options** in **Control Panel** and select **Advanced** tab, **Power buttons** and **When I press the power button on my computer**

Windows Server 2008: Open **Power Options** in **Control Panel** and select **Choose what the power button does**, **Power button settings** and **When I press the power button:**

When Forced stop is used in EXPRESSCLUSTER, it is recommended that this setting is configured as **No Operation**.

Script for forced stop

What is the script for forced stop?

When it is recognized that the server is failing, any script created by the user can be executed on one of the rest of servers working normally.
The failing server can be stopped forcibly by using the script.

Conditions for executing the script for forced stop

- The script for forced stop is not executed when:
 - The failover group successfully stops before the server fails
 - The server is shut down by the clpdown command, the OS shutdown command or WebManager and the failover group successfully stops
 - The cluster is stopped by the clpcl command or WebManager and the failover group successfully stops
 - The server fails and there is no failover group to perform failover from the failing server to another server (including when the failover group is not activated in the failing server)
- The script for forced stop is executed when the server is failing and there is a failover group to perform failover from the failing server to another server.

Features of the script for forced stop

Environment variables used in the script for forced stop

EXPRESSCLUSTER stores the data such as the information of a failing server to environment variables.

You can use the following environment variables for branch conditions in the script to describe the procedure tailored to the operations of your system.

Environment variable	Setting value	Description
CLP_SERVER_DOWN ...Down server name	Server name	Specifies the name of the failing server
CLP_SERVER_LOCAL ...Local server name	Server name	Specifies the name of the server where the script is executed.

Return value of the script for forced stop

Return 0 when the script terminates normally.

Displaying and changing the details of the script for forced stop

For the settings of the script for forced stop, refer to “Cluster properties Recovery tab” in Chapter 2 “Function of the Builder” in this guide.

Notes on the script for forced stop

- ◆ Describe the customer-defined process in the script to stop the server.
- ◆ When using the script for forced stop, refer to “Notes on the forced stop - Impacts on forced stop” of “The forced stop function” in Chapter 9 “Other monitor settings” in this guide.
- ◆ When the forced stop function and the script for forced stop is used together, they are executed in the following order.
 1. The forced stop function
 2. The script for forced stop
- ◆ If the internal version is 11.33, you have to edit the script again after updating the version to 11.34 or later to use the script.

Chassis Identify

What is chassis identify?

This function allows another normal server to report the server failure by blinking the chassis ID lamp using the IPMI function when it recognizes that the server is failing

Conditions for chassis ID lamp to blink

- The chassis ID lamp does not blink when:
 - Statuses other than server status becomes abnormal
 - The cluster shuts down
 - All the servers in the cluster fail
If the servers do not fail simultaneously, they blink for 250 seconds at the maximum, and eventually the chassis ID lamps of all servers go off.
 - BMC of the failing server cannot communicate with a normal server
 - There is a normal server in the cluster but EXPRESSCLUSTER is stopped
- The chassis ID lamp blinks when (the above conditions for not blinking are given priority over these conditions when they overlap):
 - When some servers in the cluster fail due to some abnormality
 - When some servers in the cluster are shut down by the shutdown command of the OS.
 - When some servers in the cluster are made to shut down by the clpdown command or WebManager
 - When EXPRESSCLUSTER is stopped by the clpcl command or WebManager in some servers in the cluster
 - When some servers in the cluster are started while EXPRESSCLUSTER Server service is configured as manual start
- Chassis ID lamp stops blinking and goes off when there are normal servers in the cluster, and the server status of the failing server returns to normal

Behavior of the chassis ID lamp blinking when the cluster stops

If the chassis ID lamp of a server in the cluster is in blinking when the cluster stops, the chassis ID lamp may keep blinking for 250 seconds at the maximum.

Commands to be used for chassis identify

The `alarms` or `ialarms` command of IPMI Management Utilities (`ipmiutil`) is used to control the chassis ID lamp. When the command cannot be executed, this function cannot be used.

Specify the following option values for the command execution in the **BMC** tab of **Server Properties**.

The alarms/ialarms command option	Configured in the BMC tab of the server properties
-N [<i>target IP address</i>]	IP address
-U [<i>user name</i>]	User name
-P [<i>password</i>]	Password

Displaying and changing the chassis identify details

For the chassis identify settings, refer to “Cluster properties Alert Service tab” and “Server Properties BMC tab” in “Chapter 2 Functions of the Builder” in this guide.

Notes on chassis identify

- **About ipmiutil**
To use this function, it is necessary to install `ipmiutil` 2.0.0 or later in each cluster server. For how to obtain `ipmiutil` and how to install it, see “Settings after configuring hardware 9. Setup of BMC and ipmiutil” in Chapter 1 “Determining a system configuration” in the *Installation and Configuration Guide*.
- **BMC network settings**
Configure the settings so that the IP address of the LAN port for BMC management and the IP address which OS uses can communicate with each other. This function cannot be used when BMC is not installed in the server, or in the environment where the network for the BMC management is blocked.
Configure the same IP address that is configured for the LAN port for the BMC management to the BMC tab of the server properties.
See the server’s manuals etc. for how to configure the IP address of the LAN port for the BMC management etc.

Alert Service

Alert Service

EXPRESSCLUSTER Alert Service is a function to report failures found in operations on EXPRESSCLUSTER to system administrators in remote locations.

Failures are reported in three ways, each serving a different purpose.

(1) E-mail report

Alert messages in the WebManager are sent by e-mail to administrators.

(2) Warning light

The warning light is a visual display of the status of the server. When the server shuts down successfully, the warning light goes off.

The e-mail report and the warning light function work independently of each other.

(3) SNMP trap sending

When a WebManager alert message is displayed, the contents of the alert are sent with an SNMP trap.

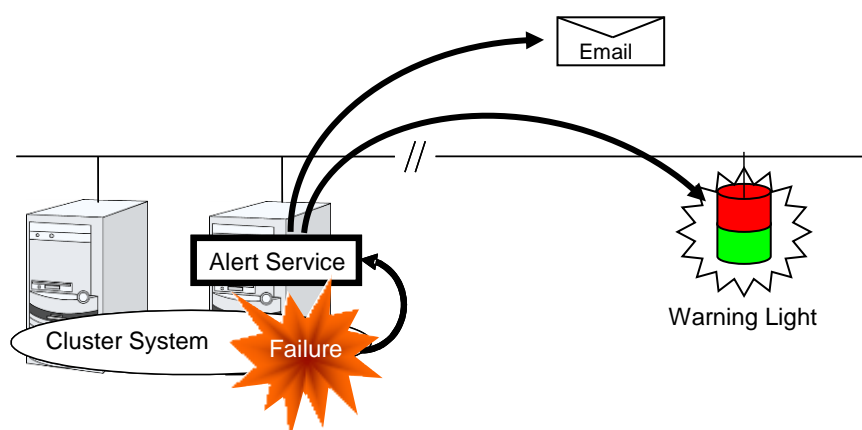

Alert Service allows you to:

- Receive information about failures while not physically located in the place where management PC is. This is achieved via e-mail reporting function.
- Receive e-mail messages on your mobile phone.
- Visually be alerted of failures by viewing a light.
- Recognize a failure audibly by reproducing the audio file for the network warning light.
- Notify the servers that are configured as the destination of the details of errors by SNMP trap sending.

Mail Report notifies the content of the alert in the following format by e-mail.

Subject:

EXPRESSCLUSTER

Body:

Message: Server [down server] has been stopped.

Type: nm

ID: 2

Host: [mail sending source server name]

Date: [send time stamp]

Notes on Alert Service

- To use the mail report and warning light function, the EXPRESSCLUSTER X Alert Service 3.3 license must be applied to the system. To operate the reporting icon, log off from the system after applying the license and then log on to the system again.
- The task of Alert Service is to send the first report of failure but not to examine or find the cause of failure. When a failure occurs, instead of using the Alert Service, try other methods, such as viewing EXPRESSCLUSTER logs or syslog, to find out the cause of the error.
- When the warning light function is used on Windows Server 2008, it is necessary to set up the subsystem for UNIX base application (SUA).
- When the warning light function is used on Windows Server 2012 or later, it is necessary to set up the command such as rsh that is supported by the warning light manufacturer.

Mail report actions

- Alert Service sends the same messages as the WebManager. For the alert messages to be reported by e-mail, see “Messages reported by event log and alert” in Chapter 12 “Error messages” in this guide.
- You can change the alerts that are reported by e-mail. For more information, see “Cluster properties Alert Service tab” in Chapter 2 “Function of the Builder” in this guide.

Warning Light status

The network warning light performs the following operations.

(1) When the server is started

When the server starts up successfully, warning light changes to green.

(2) When the server shuts down

When the server shuts down successfully, warning light goes off.

(3) When the server fails

When the server fails, its warning light flashes in red. If all servers in the cluster fail, the warning light of the server that failed last will not work because the warning light is controlled by a normal server that monitors other servers.

Once a network warning light is lit or starts flashing, it will not go off until the cluster shuts down. Run the `clplamp` command introduced in the following section to put the light out. For more information on the `clplamp` command, see “Switching off network warning light (`clplamp` command)” in Chapter 3, “EXPRESSCLUSTER command reference” in this guide.

For a network warning light (specified by NEC) that supports playback of an audio file, the setting also enables audio file reproduction to link to On/Off.

Operations of SNMP trap sending

- The contents of WebManager alert messages are sent with an SNMP trap. For alert messages subject to SNMP trap sending, see “Messages reported by event log and alert” in Chapter 12 “Error messages” in this guide.
- The alerts subject to SNMP trap sending can be changed. For more information, see “Cluster properties Alert Service tab” in Chapter 2, “Functions of the Builder” in this guide.
- For details on the SNMP trap, see “SNMP trap sending”.

Behavior of reporting icon

The icons indicate the server status. Depending on the server status, the icon displayed may change or blink.









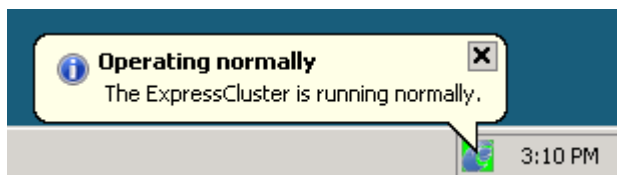













When you point the cursor to the icon, a chip is displayed.



When the server status changes, a balloon is displayed.



Icons, chips and balloons are displayed as the following:

Icons	Title of chips / balloons	Description in balloons
	EXPRESSCLUSTER(*)	None
	 Service is stopped	The EXPRESSCLUSTER Server service is stopped.
	 Service is starting	The EXPRESSCLUSTER Server service is starting.
	 Service is terminating	The EXPRESSCLUSTER Server service is about to terminate.
	 EXPRESSCLUSTER is starting	EXPRESSCLUSTER is starting up. Wait until all nodes are started.
	 Operating normally	EXPRESSCLUSTER is running normally.
	 Abnormal resource	Check the resource marked as abnormal on the WebManager.
	 Isolated	Recover the server to the cluster.
	 Stopped	EXPRESSCLUSTER is stopped.
	 Cluster suspended	The cluster is being suspended.
	 Cluster resumed	The cluster is being resumed.

(*) Before EXPRESSCLUSTER is started, the “EXPRESSCLUSTER” chip may be displayed for a while.

SNMP linkage

SNMP linkage

SNMP linkage enables SNMP trap sending from EXPRESSCLUSTER and information acquisition by SNMP from an SNMP manager according to the EXPRESSCLUSTER MIB definitions.

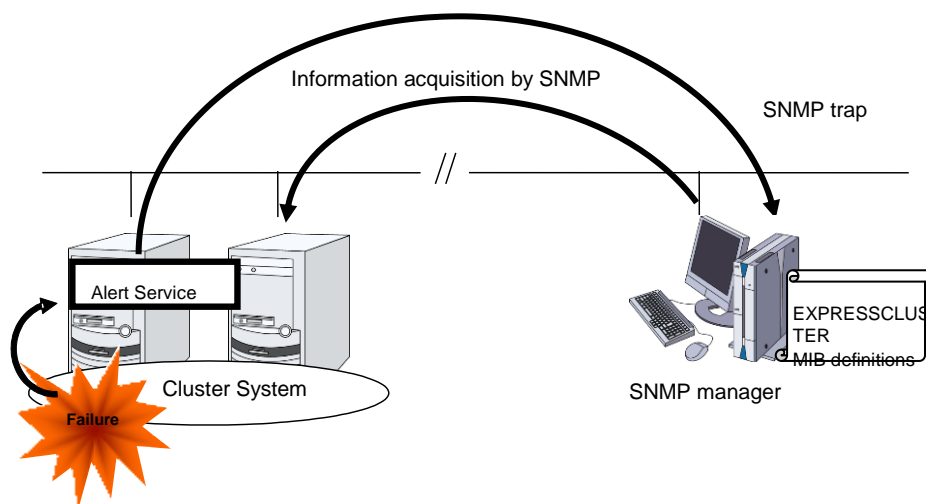

EXPRESSCLUSTER MIB definitions

The information sent/acquired with SNMP linkage is configured by the MIB definition files.

To use the functions of SNMP trap sending and information acquisition by SNMP, described later, MIB definition files are required.

To receive SNMP traps from EXPRESSCLUSTER by using an SNMP manager, or to acquire cluster statuses from an SNMP manager, set the EXPRESSCLUSTER MIB definition files in the SNMP manager.

For how to set the MIB definition files in an SNMP manager, refer to the manual for the SNMP manager.

The EXPRESSCLUSTER MIB definition files are placed in the following directory on the EXPRESSCLUSTER X CD-ROM.

```
<EXPRESSCLUSTER_X_CD-ROM>\Common\<version number>\common\mib
```

The MIB definition files provide the functions described below.

No.	MIB definition file	Description
(1)	NEC-CLUSTER-SMI.mib	Configures the EXPRESSCLUSTER MIB tree root path.
(2)	NEC-CLUSTER-EVENT-MIB.mib	Configures the trap and MIB definitions for the EXPRESSCLUSTER SNMP trap sending function.
(3)	NEC-CLUSTER-MANAGEMENT-MIB.mib	Configures MIB definitions for the following EXPRESSCLUSTER information: <ul style="list-style-type: none">• Cluster information• Server information• Group information

The available functions depend on the files set in the SNMP manager.

To receive SNMP traps from EXPRESSCLUSTER:

- (1) NEC-CLUSTER-SMI.mib
- (2) NEC-CLUSTER-EVENT-MIB.mib

To get information by SNMP:

- (1) NEC-CLUSTER-SMI.mib
- (3) NEC-CLUSTER-MANAGEMENT-MIB.mib

SNMP trap sending

SNMP trap sending serves to send the contents of WebManager alert messages to the SNMP manager.

The traps to be sent are defined by NEC-CLUSTER-EVENT-MIB.

NEC-CLUSTER-EVENT-MIB defines the following MIB objects.

clusterEventNotifications group

This group defines the traps to be sent. The MIB objects defined for the group function as described below.

No.	SNMP TRAP OID	Description
(1)	clusterEventInformation	Trap for information level alerts. A clusterEvent group MIB object is attached.
(2)	clusterEventWarning	Trap for warning level alerts. A clusterEvent group MIB object is attached.
(3)	clusterEventError	Trap for error level alerts. A clusterEvent group MIB object is attached.

clusterEvent group

This group defines the information appended to the traps. The MIB objects defined for the group function as described below.

No.	SNMP OID	Description
(1)	clusterEventMessage	Indicates the alert message.
(2)	clusterEventID	Indicates the event ID.
(3)	clusterEventDateTime	Indicates the time at which the alert originated.
(4)	clusterEventServerName	Indicates the server from which the alert originated.
(5)	clusterEventModuleName	Indicates the module from which the alert originated.

Information acquisition by SNMP

By using the SNMP protocol, some information about the EXPRESSCLUSTER configuration and status can be acquired. However, EXPRESSCLUSTER does not include SNMP agent functions. For an SNMP agent, Windows SNMP Service needs to be implemented separately.

SNMP agent

The SNMP agent serves to return a response about the configuration information or status information (GetResponse) to information acquisition requests (GetRequest, GetNextRequest) from an SNMP manager (network management software).

Note:

If Windows SNMP Service has been installed when EXPRESSCLUSTER Server is installed, the SNMP linkage function is automatically registered. Otherwise, it is not automatically registered.

It needs to be manually registered; for details on how to manually register it, refer to “Setting up the SNMP linkage function manually” in the *Installation and Configuration Guide*.









MIB objects acquirable with SNMP linkage

The MIB objects that can be acquired with the SNMP linkage function are defined by NEC-CLUSTER-MANAGEMENT-MIB.

NEC-CLUSTER-MANAGEMENT-MIB defines the following MIB objects.















clusterGeneral group

This group is used to acquire cluster information. The MIB objects defined for the group function as described below.

No.	SNMP OID	Description										
(1)	clusterName	Indicates the name of the cluster.										
(2)	clusterComment	Indicates the comment of the cluster.										
(3)	clusterStatus	<p>Indicates the current status of the cluster.</p> <p>The correspondence between the MIB value and the WebManager status is as described below.</p> <table border="1"> <thead> <tr> <th>MIB value</th> <th>WebManager status</th> </tr> </thead> <tbody> <tr> <td>normal</td> <td> Normal</td> </tr> <tr> <td>caution</td> <td> Caution</td> </tr> <tr> <td>error</td> <td> Error</td> </tr> <tr> <td>Unknown</td> <td>-</td> </tr> </tbody> </table>	MIB value	WebManager status	normal	 Normal	caution	 Caution	error	 Error	Unknown	-
MIB value	WebManager status											
normal	 Normal											
caution	 Caution											
error	 Error											
Unknown	-											





















clusterServer group

This group is used to acquire server information. Indexes on acquisition of clusterServerTable are sorted by server priority. The MIB objects defined for the group function as described below.

No.	SNMP OID	Description												
(1)	clusterServerLocalServerIndex	Indicates the index of the server receiving the present SNMP information acquisition request (clusterServerIndex).												
(2)	clusterServerTable	Indicates the information table for the server.												
(3)	clusterServerEntry	Indicates the server information list. The index for the list is clusterServerIndex.												
(4)	clusterServerIndex	Indicates the index for uniquely identifying the server.												
(5)	clusterServerName	Indicates the name of the server.												
(6)	clusterServerComment	Indicates a comment for the server.												
(7)	clusterServerStatus	Indicates the current status of the server. The correspondence between the MIB value and the WebManager status is as described below. <table border="1" data-bbox="874 920 1417 1328"> <thead> <tr> <th>MIB value</th> <th>WebManager status</th> </tr> </thead> <tbody> <tr> <td>online</td> <td> Online</td> </tr> <tr> <td>caution</td> <td> Suspension (Network Partition Unsolved)</td> </tr> <tr> <td>isolated</td> <td> Suspension (Isolated)</td> </tr> <tr> <td>offline</td> <td> Offline</td> </tr> <tr> <td>unknown</td> <td> Unknown</td> </tr> </tbody> </table>	MIB value	WebManager status	online	 Online	caution	 Suspension (Network Partition Unsolved)	isolated	 Suspension (Isolated)	offline	 Offline	unknown	 Unknown
MIB value	WebManager status													
online	 Online													
caution	 Suspension (Network Partition Unsolved)													
isolated	 Suspension (Isolated)													
offline	 Offline													
unknown	 Unknown													
(8)	clusterServerPriority	Indicates the priority of the server.												
(9)	clusterServerProductName	Indicates the name of the EXPRESSCLUSTER product installed on the server.												
(10)	clusterServerProductVersion	Indicates the version of the EXPRESSCLUSTER product installed on the server.												
(11)	clusterServerProductInstallPath	Indicates the installation path of EXPRESSCLUSTER on the server. If the return value is other than an ASCII character, the data might be corrupt.												
(12)	clusterServerPlatformName	Indicates the name of the platform on the server.												

clusterGroup group

This group is used to acquire group information. The MIB objects defined for the group function as described below.

No.	SNMP OID	Description																
(1)	clusterGroupTable	Indicates the information table for the group.																
(2)	clusterGroupEntry	Indicates the group information list. The index for the list is clusterGroupIndex.																
(3)	clusterGroupIndex	Indicates the index for uniquely identifying the group.																
(4)	clusterGroupName	Indicates the name of the group.																
(5)	clusterGroupComment	Indicates a comment for the group.																
(6)	clusterGroupType	Indicates the type of the group. The correspondence between the MIB value and the group type is as described below. <table border="1" data-bbox="826 817 1374 981"> <thead> <tr> <th>MIB value</th> <th>Group type</th> </tr> </thead> <tbody> <tr> <td>failover</td> <td>Failover group</td> </tr> <tr> <td>cluster</td> <td>Management group</td> </tr> <tr> <td>virtualMachine</td> <td>Virtual machine group</td> </tr> </tbody> </table>	MIB value	Group type	failover	Failover group	cluster	Management group	virtualMachine	Virtual machine group								
MIB value	Group type																	
failover	Failover group																	
cluster	Management group																	
virtualMachine	Virtual machine group																	
(7)	clusterGroupStatus	Indicates the current status of the group. The correspondence between the MIB value and the WebManager status is as described below. <table border="1" data-bbox="826 1099 1374 1621"> <thead> <tr> <th>MIB value</th> <th>WebManager status</th> </tr> </thead> <tbody> <tr> <td>online</td> <td> Online</td> </tr> <tr> <td>onlineFailure</td> <td> Online Failure</td> </tr> <tr> <td>offlineFailure</td> <td> Offline Failure</td> </tr> <tr> <td>offline</td> <td> Offline</td> </tr> <tr> <td>unknown</td> <td> Unknown</td> </tr> <tr> <td>onlinePending</td> <td> Online Pending</td> </tr> <tr> <td>offlinePending</td> <td> Offline Pending</td> </tr> </tbody> </table>	MIB value	WebManager status	online	 Online	onlineFailure	 Online Failure	offlineFailure	 Offline Failure	offline	 Offline	unknown	 Unknown	onlinePending	 Online Pending	offlinePending	 Offline Pending
MIB value	WebManager status																	
online	 Online																	
onlineFailure	 Online Failure																	
offlineFailure	 Offline Failure																	
offline	 Offline																	
unknown	 Unknown																	
onlinePending	 Online Pending																	
offlinePending	 Offline Pending																	
(8)	clusterGroupCurrentServerIndex	Indicates the index of the server on which the group is currently active (clusterServerIndex). If the group has been deactivated, the return value is -1																

Express5800/A1080a or Express5800/A1040a series linkage

Express5800/A1080a or Express5800/A1040a series linkage

Express5800/A1080a or Express5800/A1040a series linkage takes over operations by linking to EXPRESSCLUSTER if the BMC installed on a server detects an error.

This function uses BMC heartbeat resources and message receive monitor resources.

BMC heartbeat resources monitor whether the target servers are active by using the BMC network.

Setting a message receive monitor resource for Express5800/A1080a or Express5800/A1040a series linkage makes the BMC installed on the server report an error to execute a recovery operation.

Notes on Express5800/A1080a or Express5800/A1040a series linkage

To use this function, the following conditions must be satisfied.

- The hardware and firmware of the BMC must support this function. For the available models, refer to “Servers supporting Express5800/A1080a or Express5800/A1040a series linkage” in Chapter 3, “Installation requirements for EXPRESSCLUSTER” in the *Getting Started Guide*.
- The ipmi service must be started in advance.
- To use this function in the same environment as that for ESMPRO Agent, use the ESMPRO Agent control panel (ESMamsadm) to change the agent event operation after report from **Shutdown** to **No Operation**.

Source name: ESMCOMMONSERVICE, ID: C00001FD, C0000203, C0000454

[Starting the control panel (ESMamsadm)]

- 1) Log in as a root user.
- 2) Move to the directory containing ESMamsadm.

```
# cd /opt/nec/esmpro_sa/bin/
```
- 3) Start the control panel (ESMamsadm).

```
# ./ESMamsadm
```

[Specifying an operation after report for each monitor event]

- 1) Start the control panel (ESMamsadm) and select **Agent Event Setting**.
- 2) Select a source for **Source Name**. (Use the ↑ or ↓ key.)
- 3) Select an event ID for **Event ID**. (Use the ↑ or ↓ key.)
- 4) Click the **Setting...** button. The **Monitor Event Setting** window appears.
- 5) Change **Operation after Report** from **Shutdown** to **No Operation**.

For details, refer to the *ESMPRO Agent User's Guide (Linux)*.

Creating configuration information for using Express5800/A1080a or Express5800/A1040a series linkage

The following describes, using an example, how to create the configuration information needed to use the Express5800/A1080a or Express5800/A1040a series linkage function.

Sample cluster environment

The creation of configuration information is explained below using an example for configuring a cluster environment with the following network configuration. In the figure below, disk configuration and other data are omitted because they are not directly related to the Express5800/A1080a or Express5800/A1040a series linkage function.

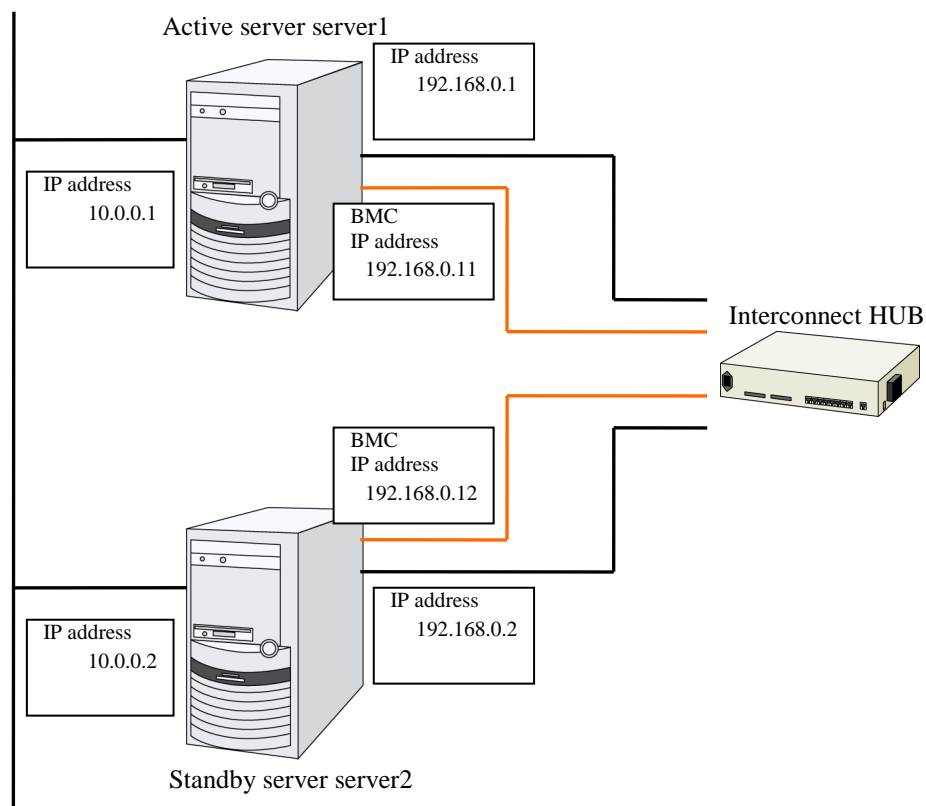

The following table lists sample values for the cluster configuration information that is used to configure the cluster system shown in the above figure. The following pages provide a step-by-step procedure for creating cluster configuration information for these conditions. When actually setting values, use the configuration information for the cluster to be configured.

	Parameter to be set	Value
Cluster configuration	Cluster name	cluster
	Number of servers	2
	Number of failover groups	1
	Number of monitor resources	2
Heartbeat resources	Number of LAN heartbeat resources	2
	Number of COM heartbeat resources	0
	Number of disk heartbeat resources	0
	Number of BMC heartbeat resources	1
First server information (master server)	Server name	server1
	Interconnect IP address (dedicated)	192.168.0.1
	Interconnect IP address (backup)	10.0.0.1
	BMC server Web console IP address	192.168.0.11
Second server information	Server name	server2
	Interconnect IP address (dedicated)	192.168.0.2
	Interconnect IP address (backup)	10.0.0.2
	BMC server Web console IP address	192.168.0.12
First group	Type	Failover
	Group name	failover1
	Starting server	All servers
	Number of group resources	-
Group resource (omitted)	-	-
	-	-
	-	-
First monitor resource (default)	Type	user mode monitor
	Monitor resource name	userw
Second monitor resource	Type	message receive monitor
	Category	BMCNOTICE
	Keyword (common)	192.168.0.1
	Keyword (Individual server setting: server1)	192.168.0.1

Parameter to be set	Value
Keyword (Individual server setting: server2)	192.168.0.2
Recovery operation	Executes the failover for the recovery target.
Recovery target	failover1

Procedure for creating cluster configuration information

The creation of cluster configuration information involves the following three basic steps: creating a cluster, creating groups, and creating monitor resources. The following shows the flow of the procedure for setting items specific to Express5800/A1080a or Express5800/A1040a series linkage. For other items, refer to Chapter 5, “Creating cluster configuration information” in the *Installation and Configuration Guide*.

Note:

An operation on cluster configuration information can be performed any number of times. Most settings can be modified later by using the rename function or the properties view function.

1 Creating a cluster

Create a cluster and add servers.

1-1 Adding a cluster

Add a cluster you want to construct and enter its name. This item contains no settings that are specific to Express5800/A1080a or Express5800/A1040a series linkage.

1-2 Adding servers

Add servers and set their server names, IP addresses, and other items. This item contains no settings that are specific to Express5800/A1080a or Express5800/A1040a series linkage.

1-3 Setting the network configuration

Set the network configuration between servers that constitute the cluster. Set BMC heartbeat resources as an item specific to Express5800/A1080a or Express5800/A1040a series linkage.

1-4 Setting network partition resolution resources

Set the network partition resolution resources. This item contains no settings that are specific to Express5800/A1080a or Express5800/A1040a series linkage.

2 Creating a failover group

Create a failover group that operates as a unit when failover occurs. This item contains no settings that are specific to Express5800/A1080a or Express5800/A1040a series linkage.

2-1 Adding a failover group

Add a group that operates as a unit when failover occurs. This item contains no settings that are specific to Express5800/A1080a or Express5800/A1040a series linkage.

2-2 Adding a group resource

Add a resource that constitutes a group. This item contains no settings that are specific to Express5800/A1080a or Express5800/A1040a series linkage.

3 Creating a monitor resource

Create a monitor resource that monitors the specified target in the cluster.

3-1 Adding a monitor resource (message receive monitor)

Add a monitor resource to use.

1 Procedure for creating a cluster

First, create a cluster. To the created cluster, add a server that is part of the cluster and determine the priorities of the server and heartbeat. Only item 1-3 contains settings that are specific to Express5800/A1080a or Express5800/A1040a series linkage.

1-1 Adding a cluster

This item contains no settings that are specific to Express5800/A1080a or Express5800/A1040a series linkage.

1-2 Adding servers

This item contains no settings that are specific to Express5800/A1080a or Express5800/A1040a series linkage.

1-3 Setting the network configuration

Set the network configuration between the servers that constitute the cluster.

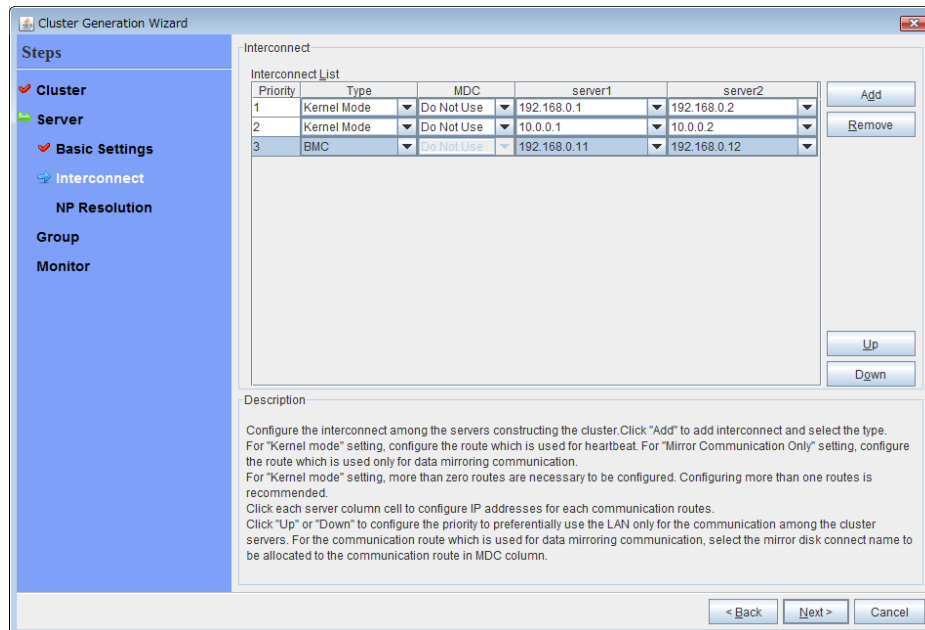

1. For the communication route used for BMC heartbeat transmission (interconnect), click a cell in the **Type** column, and then select **BMC**. Click a cell in the column for each server, and then enter the BMC server Web console IP address.

1-4 Setting network partition resolution resources

This item contains no settings that are specific to Express5800/A1080a or Express5800/A1040a series linkage.

2 Creating a failover group

This item contains no settings that are specific to Express5800/A1080a or Express5800/A1040a series linkage.

3 Creating a monitor resource

Create a monitor resource that monitors the specified target in the cluster. For the Express5800/A1080a or Express5800/A1040a series linkage function, set a message receive monitor. For details on the monitor, see "Express5800/A1080a or Express5800/A1040a series linkage with message receive monitor resources" (on page 1106).

3-1 Adding a monitor resource (message receive monitor)

Add a monitor resource that monitors the reception of an error report from the server.

1. Click **Next** in **Group**.
2. The **Monitor Resource** window appears. Click **Add**.

3. The **Monitor Resource Definition** dialog box appears. Select the monitor resource type (message receive monitor) from the **Type** box, and then enter the monitor resource name (mrw1) in the **Name** box. Click **Next**.
4. Enter the monitoring settings. Click **Next** without changing the default values.
5. Enter BMCNOTICE in the **Category** box and the IP address of the OS side of each server that can communicate with the BMC as the IP address of the destination of the error report in the **Keyword** box. Use the **Monitor(special)** tab because the IP addresses differ depending on the server. In this example, enter 192.168.0.1 for **Common** and **server1** and 192.168.0.2 for **server2**.
6. Set **Executing failover the recovery target** for **Recovery Action**. For Express5800/A1080a or Express5800/A1040a series linkage, select this setting for **Recovery Action**.
7. Set a recovery target. Click **Browse**. In the displayed tree view, select **failover1** and then click **OK**. **failover1** is set for **Recovery Target**.
8. Click **Complete**.

This completes the creation of cluster configuration information that is specific to Express5800/A1080a or Express5800/A1040a series linkage.

Express5800/A1080a or Express5800/A1040a series linkage with message receive monitor resources

This function enables EXPRESSCLUSTER to immediately execute a recovery operation if the BMC installed on the Express5800/A1080a or Express5800/A1040a series detects an error.

When this function is not used, and the BMC detects an error, server reset and other operations are executed immediately. For this reason, required operations such as application termination are not executed.

When this function is used, even if the BMC detects an error, server reset and other operations are performed after EXPRESSCLUSTER executes recovery.

The following figure is an overview of the operation that is performed when Express5800/A1080a or Express5800/A1040a series linkage with message receive monitor resources is used.

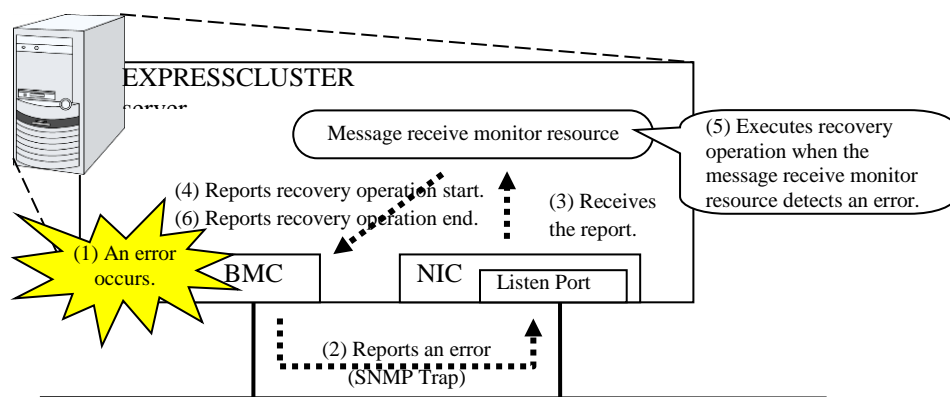

Notes on Express5800/A1080a or Express5800/A1040a series linkage with message receive monitor resources

In addition to the conditions listed in "Notes on Express5800/A1080a or Express5800/A1040a series linkage" (on page 1099), the following condition must be satisfied.

- Because SNMP Traps are used for reporting an error from the BMC to a message receive monitor resource, communication using TCP/IP must be enabled between the BMC and OS network interfaces.

Also note the following points when setting BMC linkage:

- Set BMCNOTICE for **Category**.
- Unique values must be specified for **Keyword** on different servers. Specify the IP address and port number on the OS side connected to the BMC on each server as the destination of error reports.

Displaying and changing the details of message receive monitor resources

1. Click a monitor resource icon in the tree view on the left side of the Builder window.
2. A list of monitor resources is displayed in the table view on the right side of the window. Right-click the name of the target message receive monitor resource, and then click the **Monitor(special)** tab in **Property**.
3. On the **Monitor(special)** tab, display or change the detailed settings as explained below.

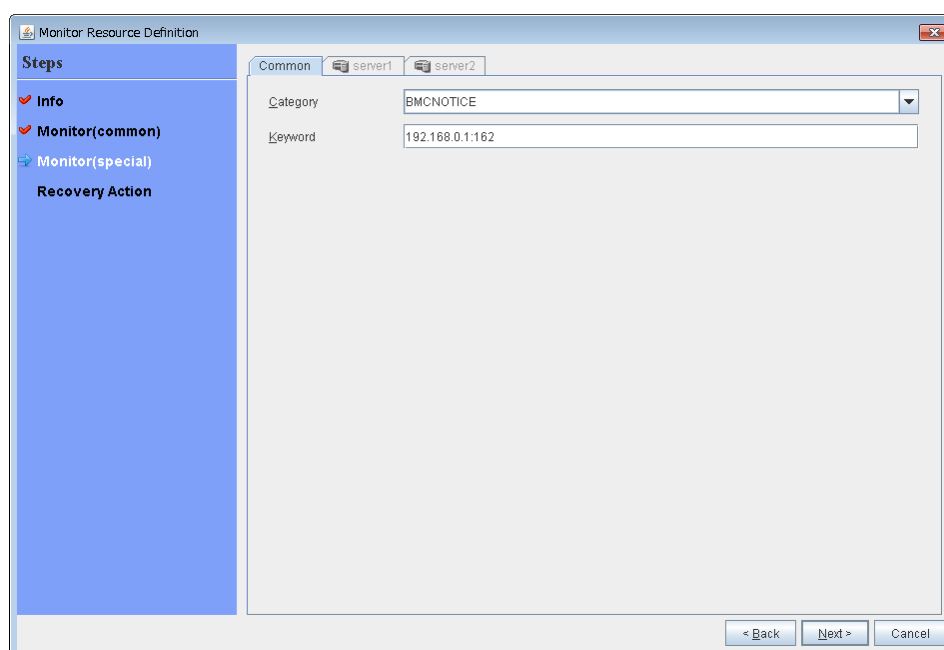

Category (within 32 bytes)

Specify a category.
Specify BMCNOTICE.

Keyword (within 255 bytes)

Specify an IP address that can communicate with the BMC on each server. In this case, specify the IP address and port number for receiving error reports.

Use individual server settings to specify the values for each server.

The port number can be omitted (default: 162). To set the port number, use the same value for all the message receive monitor resources for the same server.

The format is as follows:

`<IP address>[:<Port number>]`

AWS elastic ip resources, AWS virtual ip resources, AWS elastic ip monitor resources, AWS virtual ip monitor resources, AWS AZ monitor resources

The contents of this section have moved to "EXPRESSCLUSTER X 3.3 HA Cluster Configuration Guide for Amazon Web Services (Windows)". Please refer to the building tour guide who has that below.

<http://www.nec.com/en/global/prod/expresscluster/en/support/Setup.html>

Azure probe port resources, Azure probe port monitor resources, Azure load balance monitor resources

Setting of the Microsoft Azure environment

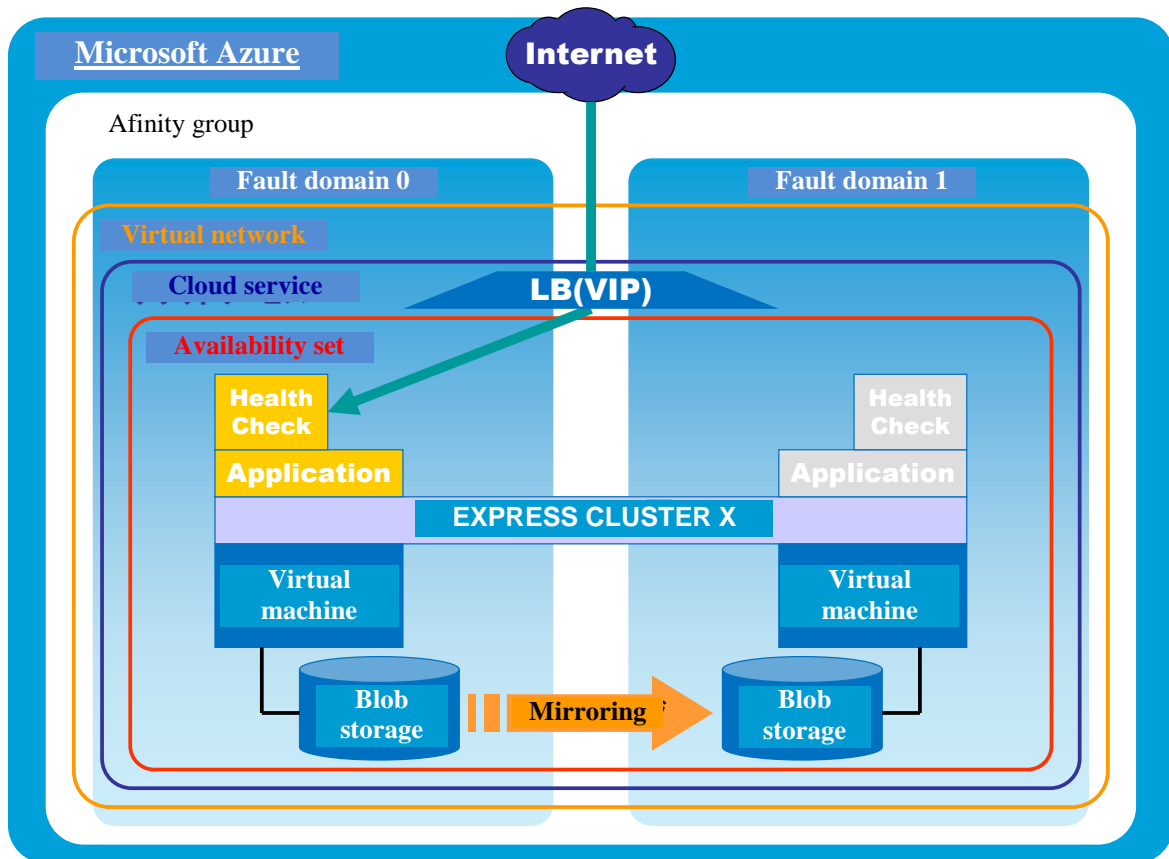

Fig. 1 System configuration

For the version information for the OSs on Microsoft Azure on which the operation of the Azure probe port resource is verified, refer to “Operation environment for Azure probe port resource” in the *Getting Started Guide*.

You must set the port number to use with the alive monitoring (Health Check in the figure above) to be implemented by the Microsoft Azure load balancer. The alive monitoring process of the load balancer periodically accesses the port subject to alive monitoring. There are two ways to set the port number to use with alive monitoring.

- Method 1: Implementing alive monitoring by using a port different from the port that provides the application. Set the port number with **Probe Port** on the Details tab in **Azure probe port Resource Properties** in the Builder.
- Method 2: Implementing alive monitoring by using the same port as that that provides the application. In this case, no Azure probe port resources, Azure probe port monitor resources, or Azure load balance monitor resources are necessary.

In the Microsoft Azure environment, you must create the following, and make settings in each virtual machine.

- Set a cloud service DNS name
- Create an affinity group
- Create a virtual network
 - Create a virtual network in the region in which you created the affinity group.
- Set a virtual network subnet
- Create a storage account
 - Create a storage account for adding a Blob to the virtual machines.
- Create virtual machines
 - Add the virtual machines that constitute a cluster.
- Set an availability set name
- Add a Blob
 - Add the Blob used with the mirror disk (cluster partition and data partition). For an explanation of the partitions for mirror disks, see "Partition settings for mirror disk resource" in Chapter 1 "Determining a system configuration" in the Installation and Configuration Guide. Respective system configuration examples for an "HA cluster with VIP control" and an "HA cluster with EIP control" are shown below. In each of the "HA cluster with VIP control" and the "HA cluster with EIP control", the VPC environment must be configured.

Log into each created virtual machine, and make the following settings. For details, see the appropriate Microsoft Azure document.

- Set a fixed IP address for the virtual machine
 - After installing the virtual machines, fix the IP addresses assigned inside subnets of the respective networks. The reason for this is to prevent the IP addresses to be assigned inside subnets from being changed due to the order in which to start the virtual machines.
- Set the end point for the application provided by EXPRESSCLUSTER
 - Set an end point to make the server that provides the application accessible from an external network, using a VIP or DNS name.

To the judgment of network partition resolution

It offers `clpazure_port_checker` commands that can be performed to determine the network partition resolution. For TCP port of the specified server, checks whether LISTEN exists.

clpazure_port_checker: the `clpazure_port_checker` command judges the network partition resolution.

Command line

```
clpazure_port_checker -h host -p port
```

- | | |
|--------------------|--|
| Description | This command is for the TCP port of the specified server in the argument, checks whether LISTEN exists.

If 5 seconds (fixed) there is no response elapsed and then determined to be abnormal(Timeout).

In the case of abnormality, it prints an error message to the stderr. |
|--------------------|--|

By executing this command from the *Understanding custom monitor resources*, it is possible to make a determination of the network partition resolution.

For an example of how to configure network partition resolution using this command, please refer to *For an example of how to configure network partition resolution*.

For network partition resolution, please refer to the *Details on network partition resolution resources*.

Option	<code>-h <i>hostname</i></code>	Determining server is specified by hostname (FQDN name or IP address). Can not be omitted.
	<code>-p <i>port</i></code>	Determining port number is specified by the port (port number or service name). Can not be omitted.
Return Value	0	Success
	1	Failure(Communication Error)
	2	Failure(Timeout)
	3	Failure(Invalid argument, Internal Error)
Configuration Example	A setting example of the custom monitor resource when carrying out from a custom monitor resource, is mentioned.	

Script created with this product

Select the **Script created with this product**, set the following command in the script.

```
EXPRESS_CLUSTER Install
Path\bin\clpazure_port_checker -h host1 -p 26001
```

Monitor Type

Please select the Synchronous.

Normal Return Value

Please set the 0.

For an example of how to configure network partition resolution

Network partition resolution(or less, NP) as example of the configuration, there are two types of the following.

1. If you want to use the Microsoft Azure load balancer (if you want to publish the work in Microsoft Azure virtual network externalities)
2. If you want to use the Microsoft Azure internal load balancing(ILB) (if you want to publish the work to the internal virtual network of Microsoft Azure)

The described an example of the setting of the case of a two-node configuration.

1. If you want to use the Microsoft Azure load balancer (if you want to publish the work in Microsoft Azure virtual network externalities)

Monitor resources**- Custom monitor resource**

This resource monitors whether communication with Microsoft Azure Service Management API is possible, and checks the health of the communication with the external network. Use the `clpazure_port_checker` command, you can create a monitor resource for communication confirmation to the Microsoft Azure of Service Management API.

For details, see Understanding custom monitor resources.

- (1) For **Monitor Resource Definition**, select **Custom monitor**.
- (2) Set **Monitor Timing** to **Always**.
- (3) Select **Script created with this product**, and then create a script to monitor communication with the Microsoft Azure Service Management API. (Sample script to create is as follows.)

```
EXPRESS CLUSTER InstallPath\bin\clpazure_port_checker -h  
management.core.windows.net -p 443
```

- (4) For **Recovery Action** set **Final action only**, for **Recovery Target**, set **LocalServer**, and for **Final Action** set **No operation**.

- IP monitor resource

This resource monitors communications between clusters made up of virtual machines, and checks the health of the communication with the internal network. To check inter-cluster communication, create one IP monitor resource for each server.

For details, see Understanding IP monitor resources.

- (1) For **Monitor Resource Definition**, select **IP monitor**.
- (2) Set **Monitor Timing** to **Always**.
- (3) For **Choose servers that execute monitoring**, select and then add an available server.
- (4) From the IP address list, select **Add**, and set the IP address of a server other than that selected in step (3).
- (5) For **Recovery Action**, set **Final action only**, for **Recovery Target**, set **LocalServer**, and for **Final Action** set **No operation**.
- (6) On the other server, create a similar resource.

- multi-target monitor resource

This resource checks the states of both of the custom monitor resource that monitors communication with Microsoft Azure Service Management API and the IP monitor resource between clusters made up of virtual machines. If the states of both monitor resources become abnormal, it executes a script that describes processing for NP resolution.

To enable NP resolution, create a multi-target monitor resource to monitor the states of the custom monitor resource for checking communication and the IP monitor resource, created as described above.

If the multi-target monitor resource detects an error, and the local server can be checked as being active and offering services normally, the resource does nothing; otherwise, it shuts down the server.

For details, see Understanding multi target monitor resources.

- (1) From **Monitor Resource Definition**, select **multi-target monitor**.
- (2) Set **Monitor Timing** to **Always**.
- (3) From the list of available monitor resources, select **Add**, and then add a total of three resources, namely, the custom monitor resource for communication checking and the IP monitor resources that have been set on two servers.
- (4) For **Recovery Action**, set **Final action only**, select **Execute Script before Final Action:**, for **Recovery Target**, set **LocalServer**, and for **Final Action** set **No operation**.
- (5) Click **Script Settings**, and then create a script to execute if the multi-target monitor resource detects an error. (Sample script to create is as follows)

```

-----
rem *****
rem Check Active Node
rem *****

EXPRESS CLUSTER InstallPath\bin\clpazure_port_checker -h
127.0.0.1 -p private port

IF NOT "%ERRORLEVEL%" == "0" (
    GOTO CLUSTER_SHUTDOWN
)

rem *****
rem Check DNS
rem *****

EXPRESS CLUSTER InstallPath\bin\clpazure_port_checker -h
DNS name of cloud service of Azure -p public port

IF "%ERRORLEVEL%" == "0" (
    GOTO EXIT
)

rem *****
rem Cluster Shutdown
rem *****
:CLUSTER_SHUTDOWN
clpdown

```

```

rem *****
rem EXIT
rem *****
:EXIT
EXIT 0
-----

```

Other settings

- Cluster property

For Microsoft Azure and ExpressCluster linkage, make the settings in the cluster properties as described below.

- (1) Migrate to **Config Mode** of the WebManager, right-click on the cluster name, and then select **Properties**.
- (2) Select the Timeout tab. For the heartbeat timeout value, set the result of "A + B + 30" (that is, "error detection time for the multi-target monitor resource + 30 seconds").

A: **Monitor interval** x (**Retry Count** + 1) of a monitor resource monitored by the multi-target monitor resource for NP resolution

* Select the larger of the results of the above calculation for the two monitors.

B: **Monitor interval** x (**Retry Count** + 1) of the multi-target monitor resource

Note: If the heartbeat timeout value is shorter than the time for which the monitor for NP resolution detects an error, a heartbeat timeout will be detected before NP resolution processing is performed. In this case, a service may be started on the standby server, causing double start of the service within the cluster.

2. If you want to use the Microsoft Azure internal load balancing(ILB) (if you want to publish the work to the internal virtual network of Microsoft Azure)

PING network partition resolution resources is used. clpazure_port_checker It isn't necessary to use the command.

For details, see Understanding network partition resolution by PING method.

Section III Maintenance information

This section provides information on operation and maintenance of the EXPRESSCLUSTER system.

- Chapter 10 The system maintenance information
- Chapter 11 Troubleshooting
- Chapter 12 Error messages

Chapter 10 The system maintenance information

This chapter provides information you need for maintenance of your EXPRESSCLUSTER system. Resources to be managed are described in detail.

This chapter covers:

• Directory structure of EXPRESSCLUSTER	1118
• How to delete EXPRESSCLUSTER logs or alerts	1120
• Mirror statistics information collection function	1121
• Communication ports	1132
• Limit on the band for mirror connect communication	1134
• What causes EXPRESSCLUSTER to shut down servers	1137
• Configuring the settings to temporarily prevent execution of failover	1140
• How to execute chkdsk/defrag	1142
• How to replace a server with a new one	1145
• Wait time for synchronized cluster startup	1146
• Changing the server configuration (add/delete)	1147
• Changing the server IP address	1150
• Changing the host name	1151
• Replacing the network card	1153
• Changing the disk configuration - For a shared disk	1154
• Changing the disk configuration - For a mirror disk	1157
• Backing up/restoring data	1159
• Performing a snapshot backup	1160
• Restoring the system disk	1161
• Replacing the shared disk	1164
• Replacing the mirror disk	1166
• Replacing the hybrid disk	1167
• Increasing the shared disk size	1169
• Increasing the mirror disk size	1170
• Increasing the hybrid disk size	1171
• Replacing the disk array controller (DAC)/updating the firmware	1173
• Replacing FibreChannel HBA / SCSI / SAS controller	1175
• Information required for inquiry	1176

Directory structure of EXPRESSCLUSTER

Note:

You will find executable files and script files that are not described in Chapter 3, “EXPRESSCLUSTER command reference” in this guide under the installation directory. Run these files only with EXPRESSCLUSTER. Any failures or troubles caused by executing them by using applications other than EXPRESSCLUSTER are not supported.

EXPRESSCLUSTER directories are structured as described below:

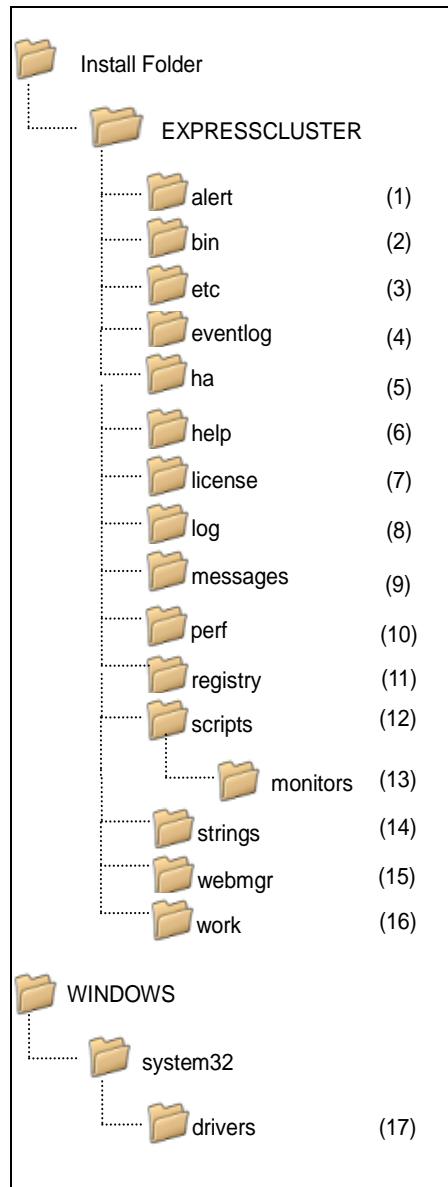

- 1.** Directory for alert synchronization
This directory stores EXPRESSCLUSTER Alert Synchronization's modules and management files.
- 2.** Directory for cluster modules
This directory stores the EXPRESSCLUSTER Server's executable files and libraries.
- 3.** Directory for cluster configuration data
This directory stores the cluster configuration files and policy file of each module.
- 4.** Directory for event logs
This directory stores libraries that are related to the EXPRESSCLUSTER event logs.
- 5.** Directory for HA products
The directory stores binary files and setting files of Java Resource Agent and System Resource Agent.
- 6.** Directory related to Help
Not used now.
- 7.** Directory for licenses
This directory stores licenses for licensed products.
- 8.** Directory for module logs
This directory stores logs produced by each module.
- 9.** Directory for report messages (alert, event log)
This directory stores alert and event log messages reported by each module.
- 10.** Directory for performance log
This directory stores performance log of mirror or hybrid disk resources and system resource of OS.
- 11.** Directory for the registry
Not used now.
- 12.** Directory for script resource scripts of group resources
This directory stores script resource scripts of group resources.
- 13.** Directory for the recovery script executed
This directory stores the script executed when an error is detected in the group resource or monitor resource.
- 14.** Directory for the string table
This directory stores string tables used in EXPRESSCLUSTER.
- 15.** Directory for the WebManager
This directory stores the EXPRESSCLUSTER X WebManager's modules and management files.
- 16.** Directory for module tasks
This is a work directory for modules.
- 17.** Directory for cluster drivers
This directory stores drivers for kernel mode LAN heartbeat and disk filter.

How to delete EXPRESSCLUSTER logs or alerts

To delete EXPRESSCLUSTER logs or alerts, perform the following procedure.

- (1) Change the **Startup Type** of the following services to **Manual** on all the servers in the cluster
 - EXPRESSCLUSTER
 - EXPRESSCLUSTER Event
 - EXPRESSCLUSTER Manager
 - EXPRESSCLUSTER Old API Support
 - EXPRESSCLUSTER Server
 - EXPRESSCLUSTER Transaction
 - EXPRESSCLUSTER Web Alert
- (2) Delete the EXPRESSCLUSTER shutdown hook registered in the Startup temporarily. Move the shortcut files in the following folder to another folder.
 - Windows Server 2003
 - <system drive>\Documents and Settings\All Users\Start Menu\Programs\Startup
 - Windows Server 2008
 - <system drive>\Users\All Users\Microsoft\Windows\Start Menu\Programs\Startup
- (3) Shut down the cluster with the WebManager or clpstdn command, and then reboot the cluster.
- (4) When the license of EXPRESSCLUSTER X Alert Service 3.3 for Windows has been registered, right-click the EXPRESSCLUSTER icon displayed on the task manager, and then select **Exit**.
- (5) To delete logs, delete the files in the following folder. Perform this operation on the server for which you want to delete the logs.
 - < EXPRESSCLUSTER installation path>\log
- (6) To delete alerts, delete the files in the following folder. Perform this operation on the server for which you want to delete the alerts.
 - < EXPRESSCLUSTER installation path>\alert\log
- (7) Return the shortcut files that were moved in (2) to the original folder.
- (8) Change the **Startup Type** of the following services to **Automatic** on all the servers in the cluster
 - EXPRESSCLUSTER
 - EXPRESSCLUSTER Event
 - EXPRESSCLUSTER Manager
 - EXPRESSCLUSTER Old API Support
 - EXPRESSCLUSTER Server
 - EXPRESSCLUSTER Transaction
 - EXPRESSCLUSTER Web Alert

- (9) Restart all the servers in the cluster.

Mirror statistics information collection function

What is the mirror statistics information collection function?

The mirror statistics information collection function collects statistics information related to the mirror function that is obtained from each mirror source in mirror disk and hybrid disk configurations.

Using the Windows OS functions (performance monitor and typeperf command), the mirror statistics information collection function can collect mirror statistics information for EXPRESSCLUSTER X and display the collected information in real time. Moreover, it can continuously output mirror statistics information to a statistic log file from the instant that the mirror is constructed.

As shown below, the collected mirror statistics information can be used during mirror construction and mirror operation.

During mirror construction	To tune the mirror setting items in the current environment, you can adjust the optimum setting by checking how each setting item influences the current environment.
During mirror operation	You can monitor the situation to determine whether a problem is likely to occur. Moreover, analysis performance improves because mirror statistics information can be collected before and after failure occurrence.

Linkage between the mirror statistics information collection function and OS standard functions

◆ Using the OS standard functions

Using the performance monitor and typeperf command, mirror statistics information can be collected and that information displayed in real time. Any counter can be selected from the subsequent “Counter names” list to continuously display and collect information over a fixed period of time. This allows you to visually check whether the mirror-related setting values are suitable for the constructed environment or whether an error has occurred during the collection of the statistics information.

For the procedure for using the performance monitor and typeperf command, see the subsequent items “Displaying mirror statistics information with the performance monitor,” “Collecting mirror statistics information from the performance monitor”, and “Collecting mirror statistics information from the typeperf command.”

◆ Specifying an object name

The object name used with the mirror statistics information collection function is “Cluster Disk Resource Performance” Specifying the “Cluster Disk Resource Performance” object enables the collection of mirror statistics information.

◆ Specifying a counter name

The counter names used by the mirror statistics information collection function are listed below.

Counter name	Meaning	Unit
	Description	
% Compress Ratio	Compression ratio	%
	Compression ratio of the mirror data to be sent to a remote server. The ratio of the compressed data size relative to the original data is used. Therefore, if 100 MB of data is compressed to 80 MB, the compression ratio is 80%.	
Async Application Queue Bytes Async Application Queue Bytes, Max	Application queue size (instantaneous value/maximum value)	Byte
	Amount of data which is retained in the user space memory and which has yet to be sent during asynchronous mirror communication. The value that appears when the latest data is collected is an instantaneous value while the value that appears when the amount of data to be retained is the greatest is the maximum value.	
Async Kernel Queue Bytes Async Kernel Queue Bytes, Max	Kernel queue size (instantaneous value/maximum value)	Byte
	Amount of data which is retained in the kernel space memory and which has yet to be sent during asynchronous mirror communication. The value that appears when the latest data is collected is an instantaneous value while the value that appears when the amount of data to be retained is the greatest is the maximum value.	
Async Mirror Queue Transfer Time Async Mirror Queue Transfer Time, Max	Time for transfer from the kernel queue to the application queue (average value/maximum value)	msec
	Average value/maximum value of the time needed to transfer data from the kernel space memory to the user space memory during asynchronous mirror communication	
Async Mirror Send Wait History Files Total Bytes Async Mirror Send Wait History Files Total Bytes, Max	History file usage (instantaneous value/maximum value)	Byte
	Total size of the data files accumulated in the history file storage folder and which have yet to be sent during asynchronous mirror communication. The value that appears when the latest data is collected is an instantaneous value while the value that appears when the amount of accumulated data is the greatest is the maximum value.	
Async Mirror Send Wait Total Bytes Async Mirror Send Wait Total Bytes, Max	Amount of data yet to be sent (instantaneous value/maximum value)	Byte
	Total amount of mirror data which is to be sent to a remote server and which has yet to be sent during asynchronous mirror communication. The value that appears when the latest data is collected is an instantaneous value while the value that appears when the amount of data that has yet be sent is the greatest is the maximum value.	
Mirror Bytes Sent Mirror Bytes Sent/sec	Mirror transmission amount (total value/average value)	Byte (Byte/sec)
	Number of bytes of mirror data sent to a remote server. The total number of bytes that appears until the latest data is collected is the total value while the number of bytes to be sent per second is the average value.	
Request Queue Bytes	Request queue size (instantaneous value/maximum value)	Byte

Counter name	Meaning	Unit
	Description	
Request Queue Bytes, Max	Amount of queue used when an IO request is received during mirror communication. The value that appears when the latest data is collected is an instantaneous value while that the value that appears when the queue size is the greatest is the maximum value.	
Transfer Time, Avg Transfer Time, Max	Mirror communication time (average value/maximum value)	msec/time
	Communication time per mirror communication used during mirror data transmission. The communication time averaged by the number of times of mirror communication used until the latest data is collected is the average value while the communication time per mirror communication which was the greatest is the maximum value.	

◆ **Specifying the instance name**

The instance name to be used by the mirror statistics information collection function is “MD,HD ResourceX.” X indicates a mirror disk number/hybrid disk number from 1 to 8. For example, if the mirror disk number of mirror disk resource “MD” is set to “2”, the mirror statistics information relating to resource “MD” can be collected by specifying instance “MD,HD Resource2.”

Moreover, if two or more resources are set, specifying instance “_Total” can collect information totalized by mirror statistics information relating to all resources that have been set.

Note:

Specify the instance name corresponding to the mirror disk number/hybrid disk number for which a resource is set. An instance for which no resource is set can be specified; however, mirror statistics information cannot be displayed/collected.

◆ **Using mirror statistics information**

Mirror statistics information that has actually been collected can be used to adjust the mirror-related setting values. If, for example, the communication speed and communication load can be confirmed from the collected mirror statistics information, it may be possible to improve the communication speed by turning the mirror-related setting values.

◆ **Displaying mirror statistics information with the performance monitor**

Procedure for displaying the mirror statistics information to be collected in real time (Example: In the case of Windows Server 2008 R2)

1. From the **Start** menu, start **Administrative Tools - Performance Monitor**.
2. Select the performance monitor.
3. Click the + button or right-click to execute **Add Counters** from the menu.
4. Save the counter setting added with **File - Save as**.
5. Starting from the saved setting, you can repeatedly use the same counter setting.

The procedure is detailed below.

Here, “Mirror Bytes Sent,” or one item of mirror statistics information, is collected as an example. The target instance is assumed to be “MD/HD Resource1.”

1. From the **Start** menu, start **Administrative Tools - Performance**.
2. From the left-hand menu tree in the window, select **Performance Monitor**.

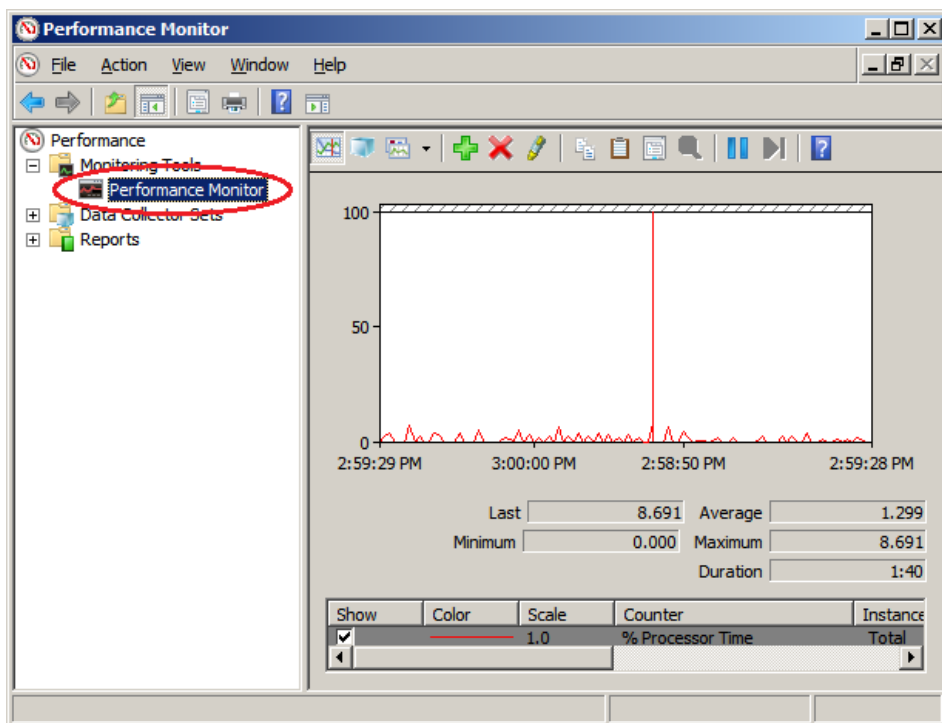

The performance monitor window appears on the right-hand side of the window.

- Click the + button or right-click to execute **Add Counters** from the menu.

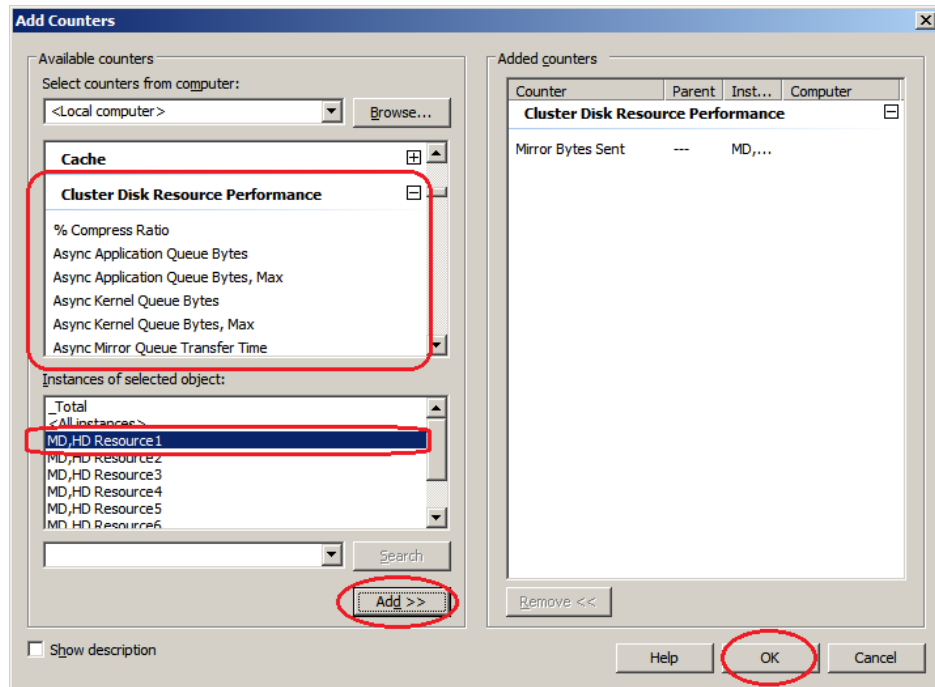

If the operation conditions are satisfied, the additional counter/instance is displayed.

Select **Cluster Disk Resource Performance**, select counter **Mirror Bytes Sent** and instance **MD,HD Resource1** and then click **Add**.

Note:

If **Cluster Disk Resource Performance** is not displayed, the linkage function is disabled. In this case, execute the following command at the command prompt to enable the linkage function, and then retry the procedure from step 1.

```
>lodctr.exe <EXPRESSCLUSTER installation path>\perf\clpdiskperf.ini
```

- Save the counter setting added with **File - Save as**.
- Starting from the saved setting, you can repeatedly use the same counter setting.

◆ **Collecting mirror statistics information from the performance monitor**

The following explains the procedure for collecting the log file of mirror statistics information from the performance monitor.

Procedure for collecting the log file (example: Windows Server 2008 R2)

1. From the **Start** menu, start **Administrative Tools - Performance Monitor**.
 2. Create a new data collector set with **Data Collector Sets - User Defined**.
 3. From **Create Data Log**, select **Performance Counter** and then click **Add**.
 4. Select **Cluster Disk Resource Performance** and then add the counter and instance to be collected.
 5. Start log collection.
-

The procedure is detailed below.

Here, “Mirror Bytes Sent,” or one item of mirror statistics information, is collected as an example. The target instance is assumed to be “MD/HD Resource1.”

1. From the **Start** menu, start **Administrative Tools - Performance Monitor**.
2. From **Data Collector Sets - User Defined**, select **Operation - New**, or from **New** of the right-click option, specify **Data Collector Set**.
 - Enter any name as the data collector set name.
 - As the data collector set creation method, select **Create manually (Details) (C)**.
3. From **Create Data Log**, select **Performance Counter** and then click **Add**.
4. Add a counter. Here, after selecting **Mirror Bytes Sent** from **Cluster Disk Resource Performance**, select **MD,HD Resource1** from **Instances of Selected object**, and then click **Add**.

MD,HD Resource1 of **Mirror Bytes Sent** is added to **Added Counter**.

After adding all the counters to be collected, click **OK** and then select **Finish**.

Note:

If **Cluster Disk Resource Performance** is not displayed, the linkage function is disabled. In this case, execute the following command at the command prompt to enable the linkage function, and then retry the procedure from step 1.

```
>lodctr.exe <EXPRESSCLUSTER installation path>\perf\clpdiskperf.ini
```

5. Start log collection. Execute **Start** from the menu with **Data Collector Sets - User Defined - (Data Collector Set Name)**.

◆ **Collecting mirror statistics information from the typeperf command**

The following explains the procedure for collecting the mirror statistics information from the typeperf command.

(Example: Windows Server 2008 R2)

1. From the **Start** menu, start **Programs - Accessories - Command Prompt**.
2. Execute typeperf.exe.

The following explains the use example in detail.

[Use example 1] Collecting the mirror communication time (specifying all instances EXPRESSCLUSTER Resource)

Case in which MD resources: md01 to md04 and HD resources: hd05 to hd08 are already registered

However, each resource is set as follows:

- The md01 mirror disk number is 1.
- The md02 mirror disk number is 2.
- :
- The hd07 hybrid disk number is 7.
- The hd08 hybrid disk number is 8.

Note:

The title is line-fed to enhance readability. Actually, the title is displayed in a horizontally row.

```
C:\>typeperf "\Cluster Disk Resource Performance(*)\Transfer Time, Avg" .....Collecting the EXPRESSCLUSTER Mirror communication time

"(PDH-CSV 4.0)","\\v-ralw2k8r2\CLSTERPRO X Disk Performance(*)\Transfer Time, Avg",
"\\v-ralw2k8r2\Cluster Disk Resource Performance(MD,HD Resource1)\Transfer Time, Avg",
"\\v-ralw2k8r2\Cluster Disk Resource Performance(MD,HD Resource2)\Transfer Time, Avg",
"\\v-ralw2k8r2\Cluster Disk Resource Performance(MD,HD Resource3)\Transfer Time, Avg",
"\\v-ralw2k8r2\Cluster Disk Resource Performance(MD,HD Resource4)\Transfer Time, Avg",
"\\v-ralw2k8r2\Cluster Disk Resource Performance(MD,HD Resource5)\Transfer Time, Avg",
"\\v-ralw2k8r2\Cluster Disk Resource Performance(MD,HD Resource6)\Transfer Time, Avg",
"\\v-ralw2k8r2\Cluster Disk Resource Performance(MD,HD Resource7)\Transfer Time, Avg",
"\\v-ralw2k8r2\Cluster Disk Resource Performance(MD,HD Resource8)\Transfer Time, Avg",
"\\v-ralw2k8r2\Cluster Disk Resource Performance(_Total)\Transfer Time, Avg"
"03/03/2010 15:21:24.546","0.24245658","0.3588965","0.488589","0.24245658","0.3588965","0.488577","0.3588965","0.488589"
"03/03/2010 15:21:24.546","0.21236597","0.6465466","0.488589","0.24245658","0.3588965","0.488589","0.2588965","0.288589"
"03/03/2010 15:21:24.546","0.24465858","0.7797976","0.488589","0.13123213","0.4654699","0.488544","0.6588965","0.288589"
"03/03/2010 15:21:24.546","0.85466658","0.5555565","0.488589","0.24245658","0.3588965","0.485689","0.7588965","0.388589"
"03/03/2010 15:21:24.546","0.46564468","0.3123213","0.488589","0.24245658","0.4388965","0.482289","0.8888965","0.338589"
"03/03/2010 15:21:24.546","0.85858998","0.3588965","0.488589","0.44245658","0.2288965","0.483289","0.3768965","0.228589"
"03/03/2010 15:21:24.546","0.47987964","0.3588965","0.488589","0.64245658","0.1288965","0.488214","0.3488965","0.428589"
"03/03/2010 15:21:24.546","0.88588596","0.3588965","0.488589","0.24245658","0.1588965","0.484449","0.3668965","0.422589"

.....Title

"sampling time", "md01", "md02", "md03", "md04", "hd05", "hd06", "hd07", and "hd08" communication times
```

[Use example 2] Collecting the amount of mirror data transmission (specifying the hd05 resource for the instance)

Case in which MD resources: md01 to md04 and HD resources: hd05 to hd08 are already registered

However, each resource is set as follows:

- The md01 mirror disk number is 1.
- The md02 mirror disk number is 2.
- :
- The hd07 hybrid disk number is 7.
- The hd08 hybrid disk number is 8.

```
C:\>typeperf "\Cluster Disk Resource Performance(MD,HD Resource5)\Mirror Bytes Sent/sec" .....Collecting the mirror transmission amount
"(PDH-CSV 4.0)", "\\v-ra1w2k8r2\Cluster Disk Resource Performance(MD,HD Resource5)\Mirror Bytes Sent/sec"
"03/03/2010 15:21:24.546", "52362", .....Title
"03/03/2010 15:21:24.546", "45564",
"03/03/2010 15:21:24.546", "25560",
"03/03/2010 15:21:24.546", "25450",
"03/03/2010 15:21:24.546", "22560",
"03/03/2010 15:21:24.546", "21597",
"03/03/2010 15:21:24.546", "35999",
"03/03/2010 15:21:24.546", "25668",
}
"sampling time","hd05" data transmission amount
```

[Use example 3] Outputting the compression ratio to the log (specifying the hd01 resource for the instance)

Case in which MD resources: md01 to md04 and HD resources: hd05 to hd08 are already registered

However, each resource is set as follows:

- The md01 mirror disk number is 1.
- The md02 mirror disk number is 2.
- :
- The hd07 hybrid disk number is 7.
- The hd08 hybrid disk number is 8.

CSV is specified as the log file format and C:\PerfData\hd01.csv as the file output destination path.

```
C:\>typeperf "\Cluster Disk Resource Performance(MD,HD Resource1)\% Compress Ratio" -f CSV -o C:\PerfData\hd01.csv .....Outputting the compression ratio to the log
```

Use [Ctrl]+[C] to stop the log output after command execution.

[Use example 4] Displaying the counter list (specifying no instance)

Case in which MD resources: md01 to md04 and HD resources: hd05 to hd08 are already registered

However, each resource is set as follows:

The md01 mirror disk number is 1.

The md02 mirror disk number is 2.

:

The hd07 hybrid disk number is 7.

The hd08 hybrid disk number is 8.

```
C:\>typeperf -q "\Cluster Disk Resource Performance" ..... Displaying the counter list

\Cluster Disk Resource Performance(*)\% Compress Ratio
\Cluster Disk Resource Performance(*)\Async Application Queue Bytes
\Cluster Disk Resource Performance(*)\Async Application Queue Bytes, Max
\Cluster Disk Resource Performance(*)\Async Kernel Queue Bytes
\Cluster Disk Resource Performance(*)\Async Kernel Queue Bytes, Max
\Cluster Disk Resource Performance(*)\Async Mirror Queue Transfer Time
\Cluster Disk Resource Performance(*)\Async Mirror Queue Transfer Time, Max
\Cluster Disk Resource Performance(*)\Async Mirror Send Wait History Files Total Bytes
\Cluster Disk Resource Performance(*)\Async Mirror Send Wait History Files Total Bytes, Max
\Cluster Disk Resource Performance(*)\Async Mirror Send Wait Total Bytes
\Cluster Disk Resource Performance(*)\Async Mirror Send Wait Total Bytes, Max
\Cluster Disk Resource Performance(*)\Mirror Bytes Sent
\Cluster Disk Resource Performance(*)\Mirror Bytes Sent/sec
\Cluster Disk Resource Performance(*)\Request Queue Bytes
\Cluster Disk Resource Performance(*)\Request Queue Bytes, Max
\Cluster Disk Resource Performance(*)\Transfer Time, Avg
\Cluster Disk Resource Performance(*)\Transfer Time, Max
```

In addition, sampling interval change, command issuance to a remote server, and the like can all be specified as options.

Use “Typeperf -?” to confirm the details of the options.

Operation of the mirror statistics information collection function

◆ Mirror statistics information log output (automatic) during operation

The mirror statistics information collection function continuously collects statistics information in the environment in which the operation condition is satisfied and then outputs it to the statistic log file. Mirror statistics information collection and log output are performed automatically. Statistic log output is detailed below.

Item	Operation	Description
Output file name	nmp_<n>.cur	<n> indicates the mirror disk No. or hybrid disk No. cur is the newest, followed by pre, pre1, pre2, ..., in the newest to oldest order.
	nmp_<n>.pre<x>	The larger the number, the older.
	nmp_total.cur	When the prescribed number of log files is exceeded, existing logs are deleted, starting with the oldest.
	nmp_total.pre<x>	total indicates the total data of all mirror disk resources/hybrid disk resources.
Output file format	Text file	Data is output to the file in the comma-separated (CSV) text format. One-line data is output for each information collection.
Output destination folder	EXPRESSCLUSTER installation folder\perfdisk	Data is output within the work folder immediately under the EXPRESSCLUSTER installation folder.
Resource to be output	For each resource + total	Log is output to one file for each mirror disk resource or hybrid disk resource that was set. If no resource is set, no log file is created. If one or more log files are created, the Total log file indicating the total value of all the resources is also created.
Output timing	Per minute	Information is output every minute. No log output occurs if the mirror statistics information output function is disabled. If the mirror statistics information log output operation is disabled, no log output occurs even though the mirror statistics information collection function is operating.
Output file size	About 16 MB	The maximum size of one file is about 16 MB. If the upper size limit is exceeded, the log file is automatically rotated and the previous log file is saved. Even if the upper size limit is not exceeded, the log file may be rotated automatically when the output data is changed.

Number of log rotations	12 generations	Up to 12 generations of log files are saved through log file rotations. If the upper rotation limit is exceeded, the oldest generation log file is automatically deleted.
-------------------------	----------------	--

Operation conditions of the mirror statistics information collection function

The mirror statistics information collection function runs when the following conditions are satisfied:

The EXPRESSCLUSTER Disk Agent service is active normally.

One or more mirror disk resources or hybrid disk resources are set.

The mirror statistic information collection function is enabled on the WebManager setting window.

Confirm the EXPRESSCLUSTER Disk Agent service status. (ex. Windows Server 2008 R2)

From the **Start** menu, start **Server Management - Service**.

Confirm that the EXPRESSCLUSTER Disk Agent service status is **Start**.

Confirm that **Startup Type** is **Auto**.

The server is required to be restarted if the service status is not **Start**.

Confirm the mirror setting.

Start WebManager.

Confirm that the mirror disk resource or hybrid disk resource is set.

Confirm the setting of the mirror statistics information collection function.

Start WebManager.

Change the mode to **Settings**. (*Specification of the prescribed setting tab/cluster properties?*)

For details of WebManager, see Chapter 1, "Functions of the WebManager" and Chapter 2, "Function of the Builder."

Notes on the mirror statistics information collection function

To operate the mirror statistics information collection function, the free space (up to about 3.4 GB) is required on disk to record the statistic log file of the mirror statistics information.

Up to 32 processes can be started for a single server with both the performance monitor and typeperf commands combined. No mirror statistics information can be collected if more than 32 performance monitors or typeperf commands are executed for a single server.

More than one of statistical information acquisition can't be done in 1 process.

For example the computer which is a target from more than one performance monitor on the other computers, and the occasion from which more than one data collect is extracted by 1 performance monitor, etc.

Communication ports

EXPRESSCLUSTER uses the following port numbers by default. You can change these port numbers by using the Builder. Make sure that the programs other than EXPRESSCLUSTER do not access these port numbers.

To set up a firewall for the server, make sure that the following port numbers can be accessed.

Server – Server					
From			To		Remarks
Server	Auto-assignment ¹	→	Server	29001/TCP	Internal communication
Server	Auto-assignment	→	Server	29002/TCP	Data transfer
Server	Auto-assignment	→	Server	29003/UDP	Alert synchronization
Server	Auto-assignment	→	Server	29004/TCP	Communication between disk agents
Server	Auto-assignment	→	Server	29005/TCP	Communication between mirror drivers
Server	29106/UDP	→	Server	29106/UDP	Heartbeat (kernel mode)

Server – Client					
From			To		Remark
Server	Auto-assignment	→	Server	29007/TCP 29007/UDP	Client-server communication

Server - WebManager					
From			To		Remarks
WebManager	Auto-assignment	→	Server	29003/TCP	http communication

Integrated WebManager connected server-Server to be managed					
From			To		Remarks
Integrated WebManager connected server	Auto-assignment	→	Server	29003/TCP	http communication
Server to be managed by the Integrated WebManager	29003	→	Client	29010/UDP	UDP communication

¹ An available port number at the time is automatically assigned.

Other					
From			To		Remarks
Server	Auto-assignment	-	Network warning light	Refer to the manual for each product.	Network warning light control
Server	Auto-assignment	-	Server BMC management LAN	623/UDP	BMC control (forced stop/chassis identify)
Server BMC management LAN	Auto-assignment	-	Server	162/UDP	Monitoring target of the external linkage monitor set for BMC identify
Server BMC management LAN	Auto-assignment	-	Server BMC management LAN	5570/UDP	BMC HB communication
Server	Auto-assignment	-	Monitoring target	Icmp	IP monitor
Server	Auto-assignment	-	NFS server	Icmp	Monitoring if the NFS server of the NAS resource is active
Server	Auto-assignment	-	Monitoring target	Icmp	Monitoring target of a Ping network partition resolution resource
Server	-	-	Server	Management port number set in the Builder	JVM monitor resource
Server	-	-	Monitoring target	Connection port number set in the Builder	JVM monitor resource
Server	-	-	Server	Load balancer linkage management port number set in the Builder	JVM monitor resource

If mirror connect monitor resources are going to be used, you need to let icmp packets through because EXPRESSCLUSTER checks if ping reaches between servers. If mirror connect monitor resources are going to be used, modify firewall settings so that ping reaches between servers.

Limit on the band for mirror connect communication

You can set a limit on the communication band used for mirror connect communication by using the standard Windows Local Group Policy Editor (Policy-based QoS). A limit is set for each mirror disk connect. This method is useful for setting a limit on the communication band for all mirror disk resources or hybrid disk resources using the specified mirror disk connect.

Note:

Policy-based QoS in the Local Group Policy Editor is available with Windows Server 2008 or Windows Server 2008 R2.

Procedure for setting a limit on the band for mirror connect communication

To set a limit on the band for mirror connect communication, follow the procedure described below. The following describes the procedure using Windows Server 2008 R2 as the OS.

1. Setting the properties of a network adapter

- Click **Start, Control Panel**, then **Network and Sharing Center**. Then, open **Properties** for a mirror disk connect.
- Check the **Qos Packet Scheduler** check box when it is in **Properties**.
- Click **Install, Services**, and then **Add** buttons to select **QoS Packet Scheduler** when it is not in **Properties**.

2. Starting the Local Group Policy Editor

To set a limit on the band, use the Local Group Policy Editor. From the **Start** menu, click **Run**, and then execute the following command:

```
gpedit.msc
```

3. Creating a policy

Create a policy for a limit on the band. In the left pane, click **Local Computer Policy, Computer Configuration**, then **Windows Settings**, and then right-click **Policy-based QoS** and select **Create New Policy**.

3.1. Policy-based QoS - Create a QoS policy window

Set items as follows.

Policy name

Enter a policy name for identification.

Specify DSCP value

Set the IP priority. This setting is optional. For details, see **Learn more about QoS Policies**.

Specify Outbound Throttle Rate

Check the **Specify Outbound Throttle Rate** check box. Specify an upper limit on the communication band used for the mirror disk connect in units of **KBps** (kilobytes per second) or **MBps** (megabytes per second).

After setting the required items, click the **Next** button.

3.2. Policy-based QoS - This QoS policy applies to: window

Set this item as follows.

This QoS policy applies to: (application specification)

Select **All applications**.

After setting the required items, click the **Next** button.

3.3. Policy-based QoS - Specify the source and destination IP addresses. window

Set these items as follows.

This QoS policy applies to: (source IP address specification)

Select **Only for the following source IP address or prefix** and then enter the source IP address used for the mirror disk connect.

This QoS policy applies to: (destination IP address specification)

Select **Only for the following destination IP address or prefix** and then enter the destination IP address used for the mirror disk connect.

After setting the required items, click the **Next** button.

3.4. Policy-based QoS - Specify the protocol and port numbers. window

Set these items as follows.

Select the protocol this QoS policy applies to (S)

Select **TCP**.

Specify the source port number:

Select **From any source port**.

Specify the destination port number:

Select **To this destination port number or range** and then specify the mirror driver port number (default: 29005).

4. Reflecting the policy

Click the **Finish** button to apply the settings. The set policy is not immediately reflected, but according to the automatic policy update interval (default: within 90 minutes). To reflect the set policy immediately, update the policy manually. From the **Start** menu, click **Run**, and then execute the following command:

```
gpupdate /force
```

This completes the setting of a policy.

Procedure for suspending or releasing the limit on the band for mirror connect communication

To suspend or release the limit on the band for mirror connect communication, follow the procedure described below. The following describes the procedure using Windows Server 2008 R2 as the OS.

1. Starting the Local Group Policy Editor

To suspend or release the limit on a band, use the Local Group Policy Editor. From the **Start** menu, click **Run**, and then execute the following command:

```
gpedit.msc
```

2. Suspending a policy by changing its setting or deleting the policy

➤ To suspend a limit on the band

To suspend a limit on the band, change the setting for the policy for the limit on the band. Right-click the target QoS policy and then choose **Edit Existing Policy**. Then, uncheck the **Specify Outbound Throttle Rate** check box.

After making this setting, click the **OK** button.

➤ To release a limit on the band

To release a limit on the band, delete the policy for the limit on the band. Right-click the target QoS policy and then choose **Delete Policy**. The pop-up message "Are you sure you want to delete the policy?" appears. Click **Yes**.

3. Reflecting the policy

The modification or deletion of a policy is not immediately reflected, but according to the automatic policy update interval (default: within 90 minutes). To reflect the deletion or modification immediately, update the policy manually. From the **Start** menu, click **Run**, and then execute the following command:

```
gpupdate /force
```

This completes the setting of a policy.

What causes EXPRESSCLUSTER to shut down servers

When any one of the following errors occurs, EXPRESSCLUSTER shuts down or resets servers to protect resources.

Final action for an error in group resource activation or deactivation

When one of the following is specified as the final action to be taken for errors in resource activation/inactivation:

Final action	Result
The cluster service stops and the OS shuts down.	Causes normal shutdown after the group resources stop.
The cluster service stops and the OS reboots.	Causes normal reboot after the group resources stop.
An intentional stop error is generated	Causes a stop error (Panic) intentionally upon group resource activation/deactivation error.

Action for a stall of resource activation or deactivation

When one of the following is specified as the action to be taken for a stall of resource activation or deactivation, and resource activation or deactivation took longer time than expected:

Action for a stall	Result
Emergency shutdown	Causes the OS to shut down upon the stall of group resource activation or deactivation.
Intended generation of a stop error	Causes a stop error (Panic) upon the stall of group resource activation or deactivation.

The OS shuts down if the resource activation or deactivation takes an unexpectedly long time. The OS shuts down, regardless of the setting of recovery in the event of a resource activation or deactivation error.

If a resource activation stall occurs, the following message is output to the event log and as an alert message.

Module type: rc

Event ID: 1032

Message: Failed to start the resource %1. (99 : command is timeout)

Description: Resource start failure

If a resource deactivation stall occurs, the following message is output to the event log and as an alert message.

Module type: rc

Event ID: 1042

Message: Failed to stop the resource %1. (99 : command is timeout)

Description: Resource stop failure

Final action at detection of an error in monitor resource

When the final action for errors in monitor resource monitoring is specified as one of the following:

Final action	Result
Stop cluster service and shut down the OS	Causes normal shutdown after the group resources stop.
Stop cluster service and reboot the OS	Causes normal reboot after the group resources stop.
An intentional stop error is generated	Causes a stop error (Panic) intentionally upon monitor resource error detection.

Forced stop action

When the setting is configured as **Use Forced Stop**:

◆ Physical machine

Forced stop action	Result
BMC reset	Causes reset in the failing server where the failover group existed.
BMC power off	Causes power off in the failing server where the failover group existed.
BMC power cycle	Causes power cycle in the failing server where the failover group existed.
BMC NMI	Causes NMI in the failing server where the failover group existed.

◆ vSphere virtual machine (guest OS)

Forced stop action	Result
VMware vSphere CLI Power off	Causes power off in the failing server where the failover group existed.

Emergency server shutdown

When the following processes terminated abnormally, clustering can not work properly. Then EXPRESSCLUSTER shuts down the server on which those processes terminated. This action is called emergency server shutdown.

- clpnm.exe
- clprc.exe

Server shut down method can be configured in **Action When the Cluster Service Process is Abnormal** of **Cluster Properties**. Followin method can be set.

- OS shutdown (default)
- Generate an Intentional Stop Error
- HW Reset²

² This function does not require ipmiutil, unlike the force stop function.

Resource deactivation error in stopping the EXPRESSCLUSTER Server service

When deactivating a resource by running `clpcl -t`, which stops the EXPRESSCLUSTER Server service fails, EXPRESSCLUSTER causes a shutdown.

Recovery from network partitioning

If all heartbeats are disrupted, network partitioning resolution takes place which results in one or all of the servers to shut down. When the server(s) is started after the shutdown, it is in the restarted status and is not clustered.

When you resolve the problem that caused the disruption of heartbeats, recover the cluster.

For details on network partitioning, see Chapter 8, “Details on network partition resolution resources” in this guide.

For information on the suspended status (restart following a shutdown) and cluster recovery, see Chapter 1, “Functions of the WebManager” in this guide.

Emergency server restart

When an abnormal termination is detected in the following processes, EXPRESSCLUSTER reboots the OS. This action is called Emergency server restart.

- EXPRESSCLUSTERDisk Agent (`clpdiskagent.exe`)
- EXPRESSCLUSTERServer (`clppmsvc.exe`)
- EXPRESSCLUSTERTransaction (`clptrnsv.exe`)

Failure in resuming the cluster

If resuming the cluster fails, the server is shutdown.

Configuring the settings to temporarily prevent execution of failover

Follow the steps below to temporarily prevent failover caused by a failed server from occurring.

- Temporarily adjust timeout

By temporarily adjusting timeout, you can prevent a failover caused by a failed server from occurring.

The `clptoratio` command is used to temporarily adjust timeout. Run the `clptoratio` command on one of the servers in the cluster.

(Example) To (temporarily) extend the heartbeat time-out to 3600 seconds (one hour) from the current time when the heartbeat time-out is set to 90 seconds:

```
clptoratio -r 40 -t 1h
```

- Releasing temporary time-out adjustment

Releases the temporary adjustment of time-out. Execute the `clptoratio` command for any server in the cluster.

```
clptoratio -i
```

Follow the steps below to temporarily prevent failover caused by a monitor error by temporarily stopping monitor resource monitoring.

- Suspending monitoring operation of monitor resources

By suspending monitoring operations, a failover caused by monitoring can be prevented.

The `clpmonctrl` command is used to suspend monitoring. Run the `clpmonctrl` command on all servers in the cluster.

(Example) To suspend all monitoring operations:

```
clpmonctrl -s
```

- Restarting monitoring operation of monitor resources

Resumes monitoring. Execute the `clpmonctrl` command for all servers in the cluster.

(Example) Resuming all monitoring operations:

```
clpmonctrl -r
```

Follow the steps below to temporarily prevent failover caused by a monitor error by suppressing the recovery operation for a monitor resource error.

- Suppressing recovery operation upon a monitor resource error

If suppression of recovery operation upon a monitor resource error is set, the monitor resource does not perform recovery even if it detects an error. To set this function, check **Inhibit the recovery action** on the **Recovery** tab in **Cluster Properties** on the Builder. The setting is applied.

- Suppress no recovery operation upon a monitor resource error

The setting specifying suppression of the recovery operation upon a monitor resource error is released. To set this function, uncheck **Inhibit the recovery action** on the **Recovery** tab in **Cluster Properties** on the Builder. The setting is applied.

When an application or service has been started using the `armload` command with `/M` or `/R` specified, that process is monitored. To temporarily prevent failover caused by a monitoring error, follow the steps below.

- Suspending monitoring for an application/service

By using the `armloadc` command, it is possible to prevent restart or failover caused by a monitoring error for an application/service started by the `armload` command.

Execute the `armloadc` command on the server on which the application/service is running.

`armloadc watchID /W pause`

- Restarting monitoring for the application/service

Resume monitoring. Execute the `armloadc` command on the server on which monitoring for the application/service has been suspended.

`armloadc watchID /W continue`

For details on the `armload` and `armloadc` commands, see Chapter 4, “Compatible command reference” in this guide.

How to execute chkdsk/defrag

How to execute chkdsk/defrag on a shared disk

Follow the steps below to execute chkdsk/defrag on a shared disk:

1. Suspend all monitor resources temporarily by using the WebManager or the clpmonctrl command.
(Example)
`clpmonctrl -s`
2. Stop the group in which the target disk resource is registered by using the WebManager or the clpgrp command.
(Example)
`clpgrp -t <group name> -h <server name>`
3. Start only the target disk resource in the group by using the WebManager or the clprsc command.
(Example)
`clprsc -s <resource name> -h <server name>`
4. Execute chkdsk or defrag on the target partition from the command prompt.
Note:
When executing chkdsk in recovery mode (/f, /r option), it is necessary to close all processes (including EXPRESSCLUSTER) before executing chkdsk.

Note:
If the message "chkdsk cannot run because the volume is being used by another process. Would you like to schedule this volume to be checked the next time the system restarts? (Y/N)" appears, select "N".

5. Stop only the target disk resource in the group by using the WebManager or the clprsc command.
(Example)
`clprsc -t <resource name> -h <server name>`
6. Start the group in which the target disk resource is registered by using the WebManager or the clpgrp command.
(Example)
`clpgrp -s <group name> -h <server name>`
7. Resume all monitor resources by using the WebManager or the clpmonctrl command.
(Example)
`clpmonctrl -r`

How to execute chkdsk/defrag on a mirror/hybrid disk

When executing chkdsk or defrag on a partition configured as a mirror disk resource, the procedure differs depending on whether the server is an active server or a standby server.

How to execute chkdsk/defrag on an active server (mirror/hybrid disk)

Refer to “How to execute chkdsk/defrag on a shared disk”

How to execute chkdsk/defrag on a standby server (mirror disk)

If you perform a chkdsk or defragmentation in restoration mode on the standby server, mirror copy overwrites partitions established as mirror disks on the active disk image, and the file system fails to be restored or optimized. This section describes the procedure for chkdsk in order to check media errors.

1. Suspend the mdw monitor resources temporarily by using the WebManager or the clpmonctrl command.

(Example)

```
clpmonctrl -s -m <mdw monitor name>
```

2. Isolate the target mirror disk resource.

(Example)

```
clpmdctrl --break <md resource name>
```

3. Enable access to the mirror disk .

(Example)

```
mdopen <md resource name>
```

4. Execute chkdsk or defrag on the target partition from the command prompt.

Note:

If the message "chkdsk cannot run because the volume is being used by another process. Would you like to schedule this volume to be checked the next time the system restarts? (Y/N)" appears, select “N”.

5. Disable access to the mirror disk.

(Example)

```
mdclose <md resource name>
```

6. Resume the mdw monitor resources by using the WebManager or the clpmonctrl command.

(Example)

```
clpmonctrl -r -m <mdw monitor name>
```

7. If automatic mirror recovery is disabled, perform mirror recovery manually from Mirror Disk Helper.

How to execute chkdsk/defrag on a standby server (hybrid disk)

If you perform a chkdsk or defragmentation in restoration mode on the standby server, mirror copy overwrites partitions established as hybrid disks on the active disk image, and the file system fails to be restored or optimized. This section describes the procedure for chkdsk in order to check media errors.

1. Suspend the hdw monitor resources temporarily by using the WebManager or the clpmonctrl command.

(Example)

```
clpmonctrl -s -m <hdw monitor name>
```

2. Isolate and enable access to the target hybrid disk resource.

(Example)

```
clphdsnapshot --oprn <hd resource name>
```

3. Execute chkdsk or defrag on the target partition from the command prompt.

Note:

If the message "chkdsk cannot run because the volume is being used by another process. Would you like to schedule this volume to be checked the next time the system restarts? (Y/N)" appears, select "N".

4. Disable access to the mirror disk ..

(Example)

```
clphdsnapshot --close
```

5. Resume the mdw monitor resources by using the WebManager or the clpmonctrl command.

(Example)

```
clpmonctrl -r -m <hdw monitor name>
```

6. If automatic mirror recovery is disabled, perform mirror recovery manually from Mirror Disk Helper.

How to replace a server with a new one

When you replace a server in a cluster environment, follow the instructions below:

1. Set up a new server in the same way as the failed server.
 - When using a shared disk, do not connect the new server to the shared disk yet.
 - Set the same computer name and IP address as the failed server.
 - Register the EXPRESSCLUSTER license and apply updates as they have been registered and applied before.
 - If there were cluster partition and/or data partition of a mirror disk or hybrid disk on the local disk of the failing server, allocate these partitions and assign drive letters for them as they were configured in the failing server. When you use the disk of the failing server, configure drive letters for the partitions, though allocating partitions is not necessary.
 - When using a shared disk, set the SCSI controller or the HBA that is connected to the shared disk to be filtered in **Filter Settings of Shared Disk** upon installing the EXPRESSCLUSTER Server.
 - After the setup, shut it down and power it off.

Important:

In **Filter Settings of Shared Disk**, set the SCSI controller or the HBA that is connected to the shared disk to be filtered. If the new server is connected to the shared disk when it has not been set to be filtered, data on the shared disk may be corrupted.

2. If the failed server is still running, shut it down and remove it from the shared disk and the LAN, and make sure other servers in the cluster are working properly. (Ignore errors caused by the failed server being stopped.)
3. Start the new server while it is connected to the LAN. When using a shared disk, start the server while it is also connected to the shared disk.
4. When using the shared disk, on the new server, use Disk Management (On the **Start** menu, point to **Settings**, and click **Control Panel**. Double-click **Administrative Tools** and then **Computer Management**, and click **Disk Management**.) to confirm that the shared disk is visible, and set the same drive letter as the failed server.
 - At this point, access to the shared disk is controlled, so the disk data cannot be referred.
5. Connect to a server in normal operation in the cluster by using the Web browser to start the Builder. When using a shared disk, click **Properties**, **HBA** tab and **Connect** on the new server to check or modify the information on HBA and partitions.

Important:

On the **HBA** tab of **Properties** of the new server, set the SCSI controller or the HBA that is connected to the shared disk to be filtered. If the shared disk is connected when it has not been set to be filtered, data on the shared disk may be corrupted.

6. When there is any mirror disk resource or hybrid disk resource in the resources used in the new server, stop the failover group containing these resources from the WebManager.
7. Run “clppl --suspend --force” from the command prompt on the server in normal operation in the cluster and suspend the cluster.
 - A server is recognized to have stopped, so the cluster cannot be suspended from the WebManager.

8. Upload the updated cluster configuration data from the Builder.
 - When the message “There is difference between the disk information in the configuration information and the disk information in the server. Are you sure you want automatic modification?” appears, select **Yes**.
9. Resume the cluster from the WebManager. If you stopped any group in step 6, start it.

Note:

If you resume the cluster from the WebManager, the error message “**Failed to resume the cluster. Click the Reload button, or try again later.**” is displayed, but ignore it. This is displayed because the new server has not been suspended.

10. Right-click the new server on the WebManager, and select **Service** and then **Start**.
11. When **Off** is selected for **Auto Return** on the **Auto Recovery** tab in **Cluster Properties**, right-click the server where EXPRESSCLUSTER has been reinstalled by using the WebManager and select **Recover**.
12. When a mirror disk resource or hybrid disk resource exists in the resources used in the new server and the **Auto mirror recovery** check box is not selected in **Properties** of the cluster, copy the mirror disk or hybrid disk fully from Mirror Disk Helper.

Important:

If the server that operates in another mirror disk type cluster is replaced with a new server, differential copy is executed automatically. After differential copy is completed, perform full copy manually. If you do not perform full copy, a mirror disk data inconsistency will occur.

13. Move group as necessary. When mirror disk or hybrid disk is being fully copied, complete copying before moving.

Wait time for synchronized cluster startup

Even all servers in a cluster are powered on simultaneously, it does not always mean that EXPRESSCLUSTER will start up simultaneously on all servers. EXPRESSCLUSTER may not start up simultaneously after rebooting the cluster following shutdown. Because of this, one server waits for other servers in the cluster to start.

By default, 5 minutes is set to the startup synchronization time. To change the default value, click **Cluster Properties** in the Builder, click the **Timeout** tab, and select **Synchronize Wait Time**.

For more information, see “Timeout tab” in Chapter 2, “Function of the Builder” in this guide.

Changing the server configuration (add/delete)

Adding a server

To add a server, follow the steps below:

Important:

When adding a server in changing the cluster configuration, do not make any other changes such as adding a group resource.

1. Make sure that the cluster is working properly.
 2. Start the server to add. For using the shared disk, make sure the server to add is not connected to the shared disk and then start the server to add.
-

Important:

To use the shared disk, do not connect the server to the shared disk before setting it up and powering it off. Data on the shared disk may be corrupted.

3. Configure the settings that should be done before setting up the EXPRESSCLUSTER Server on the server to add. However, to use the shared disk, do not configure the settings for the disk in this step.
-

Related Information:

As for the settings to be configured before the setup, see “Settings after configuring hardware” of Chapter 1, “Determining a system configuration” in *Installation and Configuration Guide*.

4. Set up the EXPRESSCLUSTER Server to the server to add. Enter the port numbers of the WebManager and the disk agent. Configure the same settings for the port number as the server that has been already set up. To use the shared disk, set the HBA that is connected to the shared disk to be filtered. Register the license as necessary. After the setup, shut down the server to add and power it off.
-

Important:

If the shared disk is not set to be filtered in **Filter Settings of Shared Disk** when setting up the EXPRESSCLUSTER Server, do not connect to the shared disk even after the setup completes. Data on the shared disk may be corrupted. Reinstall EXPRESSCLUSTER and set the shared disk to be filtered.

5. Start the server to add. To use the shared disk, connect the disk to the server to add at first, and then start the server.
6. To use the shared disk, configure the settings for the disk on the server to add.
 - Use Disk Management (On the **start** menu, point to **Settings**, and click **Control Panel**. Double-click **Administrative Tools** and then **Computer Management**, and click **Disk Management**.) to confirm that the shared disk is visible.
 - Set the switchable partitions for disk resources and the partitions used as the cluster partition or data partition for hybrid disk resources so that they can be accessed from all the servers by using the same drive letters.
 - On all the servers, set the same drive letter to the disk heartbeat partitions to be used for the disk network partition resolution resources.
 - At this point, access to the shared disk is controlled, so the disk data cannot be referred.
7. Access to other server in the cluster via the Web browser and start the Builder. Right-click **Servers** on the tree in the left pane of the Builder, and select the server to add.

8. By using the Builder, configure the following settings of the server to add.
 - Information on the HBA and the partition on the **HBA** tab of **Properties** of the server to add (when using the shared disk).
 - Information on the disk heartbeat partition on the **NP Resolution** tab of **Cluster Properties** (when using the shared disk).
 - Information on the **Source IP Address** of the server to add on the **Details** tab of **Properties** of the virtual IP resource (when using the virtual IP resource).
 - **IP Address** of the server to add on the **Monitor(special)** tab of **Properties** of the NIC Link Up/Down monitor resource (when using the NIC Link Up/Down monitor resource).
 - Information on the **ENI ID** of the server to add on the **Details** tab of **Properties** of the AWS elastic IP resources (when using an AWS Elastic IP resource).
 - Information on the **ENI ID** of the server to add on the **Details** tab of **Properties** of the AWS virtual IP resources (when using an AWS virtual IP resource).
 - Information on the **IP Address** of the server to add on the **Details** tab of **Properties** of the Azure DNS resources (when using an Azure DNS resource).

Important:

On the **HBA** tab of **Properties** of the server to add, set the SCSI controller and the HBA connected to the shared disk to be filtered. If the shared disk is connected when it has not been set to be filtered, data on the shared disk may be corrupted.

9. When using a hybrid disk resource in the added server, right-click the **Servers** on the tree in the left pane of the Builder, and select **Properties**. Select **Settings** in **Server Group** and add the server to **Servers that can run the Group**. Do this for required servers only.
10. Right-click the failover group on the tree in the left pane of the Builder, and select the properties. Add the server that can be started on the **Startup Server** tab. Add the server that can be started only to the required failover group.
11. Select **Apply the Configuration File** from the **File** menu of the Builder, and apply the cluster configuration data to the cluster. Suspend and resume the cluster.
 - When the message “There is the disk information that is not configured. Are you sure you want automatic configuration?” appears, select **Yes**.

Note:

If the cluster is resumed, the message “Resume the cluster failed.” is displayed, but ignore it. This message is displayed because the server to add is not suspended.

12. If the cluster has been stopped, start it.
13. Restart the service of the added server with the WebManager. When **Off** is selected for **Auto Return** on the **Auto Recovery** tab in **Cluster Properties**, recover the cluster by using the WebManager manually.
14. Move group as necessary.

Deleting a server

To delete a server, follow the steps below:

Important: When deleting a server in changing the cluster configuration, do not make any other changes such as adding a group resource.

1. From the WebManager, stop the server to delete, close all the connections including LANs, SCSIs and COMs.

Important:

When the shared disk is used, take the following steps after closing all the connections to the shared disk completely. If a connection to the shared disk is kept after uninstalling EXPRESSCLUSTER, data on the shared disk may be corrupted.

2. When using mirror disk resources or hybrid disk resources, stop the target group used for resources from WebManager.
3. Make sure that the cluster is working properly. (However, ignore errors in the server to be deleted.)
4. Run the “clppl --suspend --force” command at the command prompt, and suspend only the server that has been started.
5. When the server to be deleted is registered in a server group, right-click the **Servers** in the tree in the left pane of the Builder, and then select **Properties**. Select **Settings in Server Group** and delete the server from **Servers that can run the Group**.
6. Right-click the server to delete on the tree in the left pane of the Builder, and select **Remove the server**.
7. When using mirror disk resources or hybrid disk resources, right-click the target resource and select **Remove Resource** from Builder.
8. Execute “clppl --suspend --force” from command prompt on the server in normal operation in the cluster to suspend only the servers in operation. When the server group configuration has been changed, stop the cluster from the WebManager.
9. Select **Apply the Configuration File** from the **File** menu of the Builder, and apply the cluster configuration data to the cluster.
10. Resume the cluster by using the WebManager.
11. Click **Reload** on the WebManager to verify the cluster is properly working.
12. Uninstall EXPRESSCLUSTER from the server you have deleted.

Changing the server IP address

To change the server IP address after you have started the cluster system operation, follow the instructions below.

When changing the mirror connect IP address is not required

1. Make sure that the cluster is working properly.
2. Suspend the cluster by using the WebManager.
3. Change the OS network configuration in the **Properties** of **My Network Places**.
4. Change the IP address on the **Interconnect** tab of the **Cluster Properties** by using the Builder.
5. If the changed IP address is used for the NIC Link Up/Down monitor resource, change the IP address on the **Monitor(special)** tab of the monitor resource properties.
6. Select **Settings** in **Integrated WebManager** in **WebManager** tab in the **Properties** of the cluster on the Builder. When the IP address is registered, change the IP address.
7. Select **Apply the Configuration File** from the **File** menu of the Builder, and apply the cluster configuration data to the cluster.
8. Resume the cluster by using the WebManager.

When changing the mirror connect IP address is required

1. Make sure that the cluster is working properly.
2. Stop the cluster by using the WebManager.
3. Change the OS network configuration in the **Properties** of **My Network Places**.
4. Change the IP address on the **Interconnect** tab and the **MDC** tab of the **Cluster Properties** by using the Builder.
5. If the changed IP address is used for the NIC Link Up/Down monitor resource, change the IP address on the **Monitor(special)** tab of the monitor resource properties.
6. Select **Settings** in **Integrated WebManager** in **WebManager** tab in the **Properties** of the cluster on the Builder. When the IP address is registered, change the IP address.
7. Select **Apply the Configuration File** from the **File** menu of the Builder, and apply the cluster configuration data to the cluster.
8. Reboot the OS on all the servers.

Changing the host name

Follow the steps below if you want to change the host name of a server after you have started the cluster system operation.

Environment where the mirror disk / hybrid disk does not exist

1. Make sure that the cluster is working properly.
2. If the group is started on the server whose host name is to be changed, move the group.
3. Suspend the cluster by using the WebManager.
4. Change the host name in the properties of **My Computer**.

Note:

Do not restart the OS at this stage. The cluster configuration data will not be able to be applied until the OS is completely restarted.

5. Right-click the server name on the tree in the left pane of the Builder, and select **Rename Server**.
6. Use Builder to save the cluster configuration information in which the server name has been changed in a disk area accessible from a cluster server.
 - When the Builder is used on a cluster server, save the information in the local disk. When the Builder is used in another PC, save the information in the shared disk that can be accessed from the cluster server or save it in an external media or the like and then copy it to the local disk of a cluster server.
7. Run the following command on one of the cluster servers to upload the saved cluster configuration information.

```
clpcfctrl --push -x <path_of_the_cluster_configuration_information> --nocheck
```
8. Shutdown the OS on the server you have changed the host name.
9. Resume the cluster from the WebManager.

Note:

If the cluster is resumed from the WebManager, the error message “Failed to resume the cluster. Click the Reload button, or try again later.” is displayed, but ignore it. This message is displayed because the server whose host name was changed is not suspended.

10. Execute the server of which the host name has been changed. When **Off** is selected for **Auto Return** on the **Auto Recovery** tab in **Cluster Properties**, recover the cluster by using the WebManager manually.
11. Restart the manager from the WebManager.

Environment where the mirror disk / hybrid disk exists

1. Make sure that the cluster is working properly.
2. Stop the cluster by using the WebManager.
3. Change the host name in the properties of **My Computer**.

Note:

Do not restart the OS at this stage. The cluster configuration data will not be able to be applied until the OS is completely restarted.

4. Right-click the server name on the tree in the left pane of the Builder, and select **Rename Server**.
5. Use Builder to save the cluster configuration information in which the server name has been changed in a disk area accessible from a cluster server.
 - When the Builder is used on a cluster server, save the information in the local disk. When the Builder is used in another PC, save the information in the shared disk that can be accessed from the cluster server or save it in an external media or the like and then copy it to the local disk of a cluster server.
6. Open **Administrative Tools - Services** for all servers to stop the EXPRESSCLUSTER X Disk Agent service.
7. Run the following command on one of the cluster servers to upload the saved cluster configuration information.

```
clpcfctrl --push -x  
<path_of_the_cluster_configuration_information> --nocheck
```
8. Reboot the OS on all the servers.

Replacing the network card

To replace the network card, follow the steps below. To replace the network card used for the mirror connect, follow the same steps as well.

1. Make sure that the cluster is working properly. (However, ignore errors in the network card to be replaced.)
2. If a group is running on the server whose network card is to be replaced, move the group. If the network card has been used for the mirror connect, no groups can be moved until the mirror disk recovers after the replacement. Because of this, stop the group by WebManager.
3. Open Services on the server whose network is to be changed (On the **start** menu, point to **Settings**, and click **Control Panel**. Double-click **Administrative Tools** and then **Services**.) set **Startup Type** to **Manual** from **Properties** of the following services.
 - EXPRESSCLUSTER
 - EXPRESSCLUSTER Event
 - EXPRESSCLUSTER Manager
 - EXPRESSCLUSTER Old API Support
 - EXPRESSCLUSTER Server
 - EXPRESSCLUSTER Transaction
 - EXPRESSCLUSTER Web Alert
4. Right-click the server whose network card is to be replaced on the tree in the left pane of the WebManager, and select **Shut Down**.
5. After the shutdown completes, replace the network card.
6. Start the server that the network card is replaced.
7. Configure the settings for the OS network in the **Properties** of **My Network Places**. Configure the same settings for the network as before replacing the network card.
8. Open Services on the server whose network card has been replaced (On the **Start** menu, point to **Settings**, and click **Control Panel**. Double-click **Administrative Tools** and then **Services**.), and restore **Startup Type** in **Properties** of each service which has been changed to **Manual** in step 3 to **Automatic**, and restart the server.
9. When **Off** is selected for **Auto Return** on the **Auto Recovery** tab in **Cluster Properties**, recover the cluster by using the WebManager manually.
10. Move group as necessary.

Changing the disk configuration - For a shared disk

-

Replacing the disk

To replace the shared disk, see “Replacing the shared disk” on page 1164.

Adding a disk

The following shows the procedures to add a disk resource. When you add a hybrid disk, consider “disk resource” as “hybrid disk resource”, and “partition used for disk resource” as “data partition”. Note that it is necessary to add the disk to both of two server groups when you add a hybrid disk resource. As for cluster partition, an existing cluster partition can be used, but it is necessary to configure it so that the offset index of the cluster partition does not overlap the existing hybrid disk.

1. Make sure that the cluster is working properly.
2. Stop the cluster by using the WebManager.
3. Change **Startup Attribute** to manual on the **Attribute** tab of **Properties** of the group to which the disk resource is added.
4. Select **Apply the Configuration File** from the **File** menu of the Builder, and apply the cluster configuration data to the cluster.
5. Shut down all the servers and power them off.
6. Power off the shared disk and add a disk.
7. Power on the share disk and configure its settings.
 - If it is required to build a RAID again or to change the LUN configuration, use the setup tool provided with the shared disk. For details, see the manual attached to the shared disk.
8. Start only one server, and create a partition used for the disk resource using Disk Management (On the **Start** menu, point to **Settings**, and click **Control Panel**. Double-click **Administrative Tools** and then **Computer Management**, and click **Disk Management**.) and set its drive letter. Even if the drive letter you want to assign is the same as the drive letter automatically assigned by the OS, manually assign the desired drive letter explicitly; for example, by deleting the OS assigned drive letter and then assigning the desired drive letter.

Note:

Controlling the access to the created partition is started upon its creation, so it cannot be formatted. Set only the drive letter here.

Note:

If the OS in use is Windows Server 2008 R2 or later, changing or deleting the drive letter assigned to a partition of a shared disk may fail. To avoid this, specify the drive letter according to the procedure below:

- (1) Run the following command by using the command prompt to delete the drive letter.
`mountvol <drive_letter(to_be_changed)>: /P`
 - (2) Confirm that the drive letter has been deleted from the target drive by using Disk Management (**Control Panel** > **Administrative Tools** > **Computer Management** > **Disk Management**).
 - (3) Assign a new drive letter to the drive by using Disk Management.
-

9. To create a disk heartbeat partition, create it in the same way as the disk resource, and set the drive letter. Do not format the partition.

10. To format the partition to be used as the disk resource, execute the following command to temporarily release the access restriction.

```
clpvolctrl --open <drive_letter_of_the_partition_to_be_used_as_the_disk_resource>
```

11. From disk management (**Control Panel > Administrative Tools > Computer Management > Disk Management**), format the partition to be used as the disk resource.

Note:

If “RAW” is not displayed for the partition to be formatted in **Disk Management**, the access restriction released in step 10 is not reflected to **Disk Management**. Before formatting the partition, reflect the released access restriction to **Disk Management**.

(1) From **Disk Management**, execute **Actions > Refresh**.

(2) Check that “RAW” is displayed for the partition to be formatted.

12. To restore the access restriction temporarily released in 10, above, execute the following command:

```
clpvolctrl --close  
<drive_letter_of_the_partition_to_be_used_as_the_disk_resource>
```

13. Start other servers in the cluster, and by using Disk Management (On the **Start** menu, point to **Settings**, and click **Control Panel**. Double-click **Administrative Tools** and then **Computer Management**, and click **Disk Management**.), confirm that the partition created by the first server is visible.

14. Set the drive letter of the partition used as the disk resource in the same way as the first server.

15. If the disk heartbeat partition has been created, set its drive letter in the same way as the first server.

16. Start the WebManager, and stop the cluster.

17. Start the Builder, and right-click the group to add a disk resource, and add a disk resource from **Add Resource**. Change **Startup Attribute** to manual on the **Attribute** tab of **Properties** of the group.

18. If the disk heartbeat partition has been added, in all the servers in the cluster, add a disk network partition resolution resource on the **NP Resolution** tab of **Cluster Properties**.

19. Select **Apply the Configuration File** from the **File** menu of the Builder, and apply the cluster configuration data to the cluster.

- When the message “There is the disk information that is not configured. Are you sure you want automatic configuration?” appears, select **Yes**.

20. Start the cluster by using the WebManager.

Deleting a disk

1. Make sure that the cluster is working properly.
2. Stop the cluster by using the WebManager.
3. Start the Builder and select the group whose disk resource is to be deleted. Right-click the disk resource from **Resources**, and select **Remove**. When there is a hybrid disk resource using the partition of the disk to be deleted, delete it as well.
4. When having used the partition for disk heartbeat, delete the disk network partition resolution resource in **NP Resolution** tab in **Properties** of the cluster.

5. Select **Apply the Configuration File** from the **File** menu of the Builder, and apply the cluster configuration data to the cluster.
6. Shut down all the servers, and power them off.
7. Power off the shared disk and remove it.
8. Power on the shared disk, and configure its settings.
 - If it is required to build a RAID again or to change the LUN configuration, use the setup tool provided with the shared disk. For details, see the manual attached to the shared disk.
9. Start all the servers.

Changing the disk configuration - For a mirror disk -

Replacing the disk

To replace the mirror disk, see “Replacing the mirror disk” on page 1166.

Adding a disk

To add a disk used for the mirror disk, follow the steps below:

1. Make sure that the cluster is working properly.
2. If the group is running on the server to which a disk is added, move the group.
3. Shut down only one server by using the WebManager, and power it off.
4. Expand the disk, and start the server.
5. Return the server to the cluster, and rebuild the mirror again.
6. Configure the settings for the disk by the server on which the disk is added.
 - Reserve a data partition and a cluster partition for mirror disk using Disk Management (On the **Start** menu, point to **Settings**, and click **Control Panel**. Double-click **Administrative Tools** and then **Computer Management**, and click **Disk Management**). Set their drive letters so that they will be the same on both of the servers.
7. Perform the steps 2 to 6 on other server.
8. Suspend the cluster by using the WebManager.
9. Start the Builder, and right-click the group to which the mirror disk resource is added, and add the mirror disk resource from **Add Resource**.
10. Select **Apply the Configuration File** from the **File** menu of the Builder, and apply the cluster configuration data to the cluster.
11. Resume the cluster by using the WebManager.
12. Start the added mirror disk resource or the group that added the mirror disk resource. If **Auto Mirror Initial Construction** is set to be performed in **Cluster Properties**, the initial mirror construction is started. If **Auto Mirror Initial Construction** is set not to be performed, perform the initial mirror construction manually.
13. Move group as necessary.

Deleting a disk

Follow the steps below to delete the disk used for the mirror disk.

1. Make sure that the cluster is working properly.
2. Stop the group with the mirror disk resource to be deleted by using the WebManager.
3. Suspend the cluster by using the WebManager.
4. Start the Builder and select the group from which the mirror disk resource is deleted. Right-click the mirror disk from **Resources** and select **Remove**.
5. Select **Apply the Configuration File** from the **File** menu of the Builder, and apply the cluster configuration data to the cluster.
6. Resume the cluster by using the WebManager.
7. Start the group with the WebManager.
8. Shut down the server on which the group has not been started with the WebManager, and power it off.
9. Remove the disk, and start the server.
10. Move the group, and perform the steps 8 and 9 on other server.
11. Move group as necessary.

Backing up/restoring data

Data is backed up and restored, as shown in the following image. For details on how to back up data, see the manuals of the backup software.

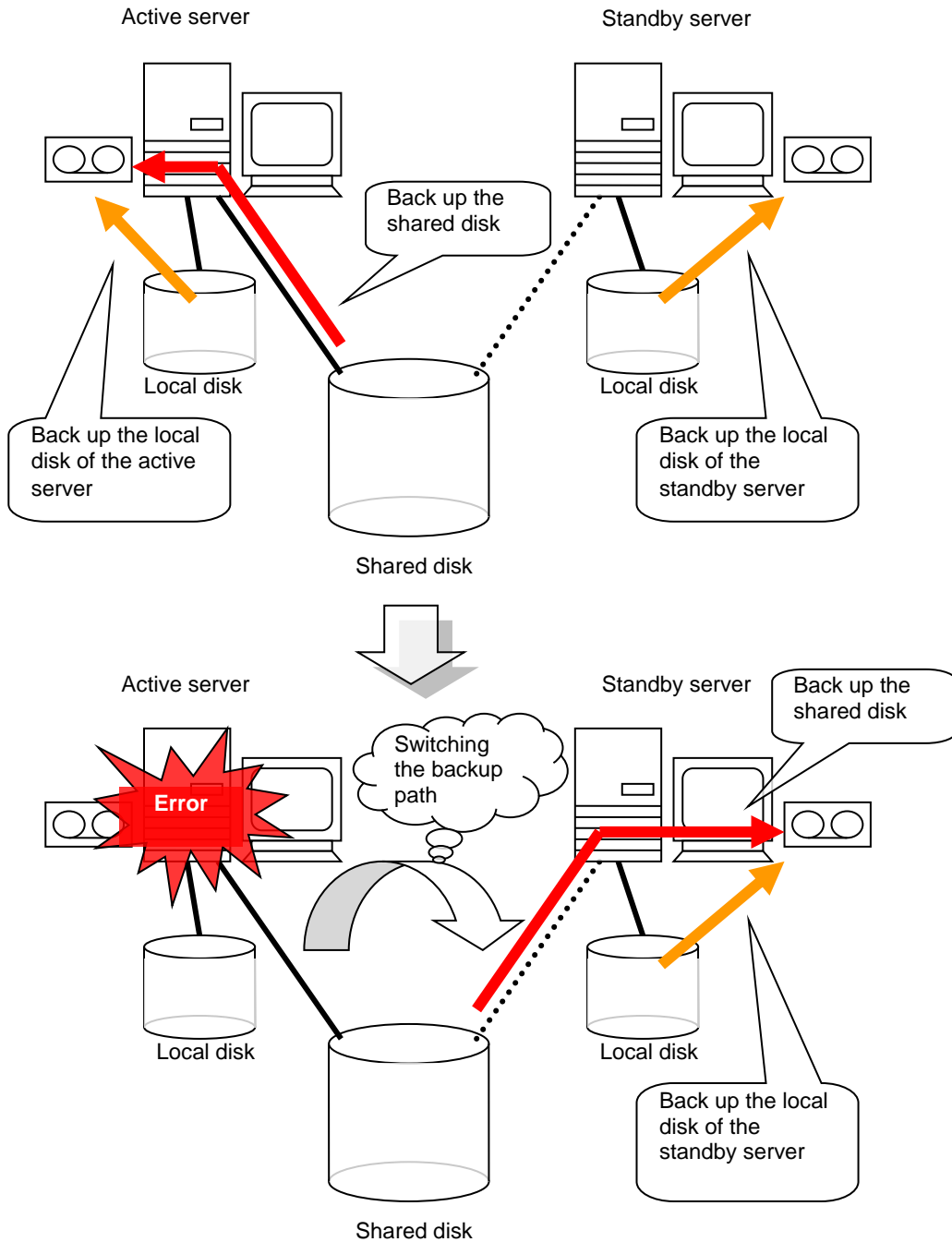

Performing a snapshot backup

When a mirror disk or a hybrid disk is used, it is possible to suspend mirroring to back up the stand-by data partition as a snapshot image. This is referred to as snapshot backup.

During executing snapshot backup, failover cannot be performed to the stand-by server or server group of the copying destination because mirroring is temporarily canceled. While in this state, cancel the access restriction to the data partition of the standby server to collect the backup.

To return from the snapshot status, control the disk access and build the mirror again.

For details for how to collect the backup, see the manuals of the backup software.

Note:

When mirroring is interrupted, note that the data at the mirroring copy destination does not necessarily have integrity as NTFS or application data, depending on the timing of the mirroring.

Performing a snapshot backup

To execute the snapshot backup for a mirror disk, follow the steps below:

1. Stop the mirror disk monitor resource that monitors the mirror disk that will be backed up on the server to be backed up.

```
clpmonctrl -s -m <mdw(mirror_disk_monitor_resource_name)>
```
2. Disconnect the mirror disk.

```
clpmdctrl --break <md(mirror_disk_resource_name)>
```
3. Allow accesses to the mirror disk.

```
mdopen <md(mirror_disk_resource_name)>
```
4. Back up necessary files.
5. Forbid accesses to the mirror disk.

```
mdclose <md(mirror_disk_resource_name)>
```
6. Start the mirror disk monitor resource that monitors the mirror disk.

```
clpmonctrl -r -m <mdw(mirror_disk_resource_monitor_resource_name)>
```
7. If automatic mirror recovery is disabled, perform mirror recovery manually from Mirror Disk Helper.

To execute the snapshot backup for a hybrid disk, collect the backup by following the steps below in a server in the standby server group of the copying destination.

1. Run the following command in the server where the backup is collected.

```
Clphdsnapshot -open <hybrid_disk_resource_name>
```
2. When the access restriction in the data partition is canceled, back up the required files.
3. Run the following command in the server where the backup has been collected to restart mirroring.

```
Clphdsnapshot --close <hybrid_disk_resource_name>
```
4. When the automatic mirror recovery is disabled, perform mirror recovery manually from Mirror Disk Helper.

For the commands, see Chapter 3, “EXPRESSCLUSTER command reference” in this guide.

EXPRESSCLUSTER X 3.3 for Windows Reference Guide

Restoring the system disk

If an error occurs in the system disk of the server, change the disk following the steps below, and restore the backup data. If EXPRESSCLUSTER has been updated or changes have been made on the configuration after the backup was created, make sure to uninstall EXPRESSCLUSTER after restoration and set this server as a new server by following the steps for server replacement.

1. If any group is running on the server where a system disk is restored (hereafter referred to as target server), move the group. When a mirror disk resource or hybrid disk resource is used, make sure that these resources are running properly after the group is moved.

Important:

If the mirror disk resource or hybrid disk resource is not in the latest status, and if the system disk is restored on the server that is not to be restored, the data on the data partition may be corrupted.

2. If the mirror disk resource or hybrid disk resource is used, execute the following procedure.
 - 2-1. Start up the Builder and right click on the cluster. In the **Properties**, select **Mirror Disk** tab and uncheck **Auto Mirror Recovery**.
 - 2-2. In **File** menu of the Builder, select **Apply the Configuration File** and apply the cluster configuration data to the cluster.
3. If the target server is running, shut down the server by selecting **Shut Down** from **Start** menu.
4. When the shared disk is connected to the target server, remove the cable connecting the target server and the shared disk. Remove the cable carefully by following the instructions shown below:
 - When a SCSI disk array is used, remove the cable from the base of the two-way cable.
 - When a Fibre Channel disk array device, remove the cable between the failing server and the Fibre Channel-HUB or the Fibre Channel-Switch.
5. Change the system disk of the server to be restored. For details on how to change the system disk, see the user's guide provided with the device.
6. Follow the normal installation procedure and install the OS.
 - To install the OS, see the user's guide provided with the server.
 - Make sure to configure the network settings when installing the OS. Apply the same OS service pack as the removed disk.
7. Make sure that the OS is running normally, and install the backup software. (For details, see the manual of the backup software.)
8. Use the backup software to restore the system disk from the backup.
 - There is no note cluster dependent note. Restore the system disk with the settings that allow the registry to be recovered and files with the same file names to be overwritten. For details, see the manual of the backup software.
9. When the EXPRESSCLUSTER Server service of the target server is configured as Auto Startup, change the settings to Manual Startup.
10. Reset its drive letter if it has been changed. Make sure that the date and time are the same as those of other servers in the same cluster.
11. When the driver of SCSI controller or FC-HBA (Host Bus Adapter) cannot be restored, re-install the above driver. For details, refer to the instruction manual of backup software.

12. Restart the target server. When the shared disk is not connected to the target server, the following steps up to 16 are not required.
13. Connect to the server that has not been restored via the Web browser to start the Builder. Open the **Properties** of the target server to configure the filter settings of the HBA connected to the shared disk.
 - Click **Connect** on the **HBA** tab to acquire the disk configuration information for the target server, and then select the check box for the HBA connected to the shared disk..
 - Do not change any settings other than above.
14. Use Builder to save the cluster configuration information in which HBA filter settings have been configured in a disk area accessible from a cluster server.
 - When the Builder is used on a cluster server, save the information in the local disk. When the Builder is used in another PC, save the information in the shared disk that can be accessed from the cluster server or save it in an external media disk or the like and then copy it to the local disk of a cluster server.
15. Run the following command on one of the cluster servers to upload the saved cluster configuration information.

```
clpcfctrl --push -x <path_of_the_cluster_configuration_information> --nocheck
```
16. Shut down the target server and connect the disk cable, and then reboot the server.
17. Start the target server and check the drive letter of the shared disk and the mirror disk (data partition and cluster partition) in **Disk Management** of the target server. If the drive letter has been changed, re-configure it as it was, restart the server and check that the drive letter is configured correctly.
18. Connect to the server which has not been restored via the Web browser to start the Builder. When the shared disk is connected to the target server and the shared disk has a volume that is not for filtering, update the information on the partition that is not for filtering in the **HBA** tab of **Properties** in the target server.
19. Perform the procedures in steps 14 and 15 above to save the cluster configuration information and then upload the information by using the clpcfctrl command from the server.
 - If the message “There is difference between the disk information in the configuration information and the disk information in the server. Are you sure you want automatic modification?” appears upon saving the configuration information, select **Yes**.
20. Restore the setting of the EXPRESSCLUSTER Server service to Auto Startup and reboot the target server.
21. When Off is selected for **Auto Return** on the **Auto Recovery** tab in Cluster Properties, right-click the target server and select **Recover** in the WebManager. If mirror disk resource or hybrid disk resource is not used on the target server, the following procedure is not required.
22. When a mirror disk resource or hybrid disk resource is created on the system disk, the resource must be recreated before mirror recovery. Perform the following procedure.
 - 22-1. From the WebManager, stop the group containing the target mirror disk resource or hybrid disk resource.
 - 22-2. Suspend the cluster.
 - 22-3. In the Builder window, right-click the target mirror disk resource or hybrid disk resource and then execute **Remove Resource**. Before deleting the resource, make a note of the parameter values required for recreating the resource.

- 22-4.** Select **Upload the Configuration File** from the **File** menu and then apply the cluster configuration data to the cluster.
 - 22-5.** Right-click the failover group and then execute **Add Resource**. For each parameter, specify the same value as that specified for the resource that was deleted.
 - 22-6.** Select **Upload the Configuration File** from the **File** menu again and then apply the cluster configuration data to the cluster.
- 23.** Execute the mirror recovery (full copy) from the Mirror Disk Helper of WebManager to all the mirror disk resources and hybrid disk resources.

Note:

Data on the server on which restore is performed (the disk is replaced) may not be up to date. A server where **restoring is not performed** must be **the source of the copy**.

In addition, Recover the mirror by **fully copying**, not partially copying because the data difference may be invalid in the process of restoring.

- 24.** When you have unchecked **Auto Mirror Recovery** in step 2, start up the Builder and right click on the cluster. In the **Properties**, select **Mirror disk** tab and check **Auto Mirror Recovery**.
- 25.** In **File** menu of the Builder, select **Apply the Configuration File** to upload the cluster configuration data to the cluster.
- 26.** Move the group as required.

Replacing the shared disk

Important: Before step 16, it is not possible to access to the partitions under HBAs to be managed by cluster, even if the partition is not access restricted.

1. Make sure that the cluster is working properly. (However, ignore errors in the disk to be replaced.)
2. Stop the cluster by using the WebManager. When the shared disk to be replaced is connected to some of the servers but not all, stop those servers only.
3. On all servers connected to the shared disk to be replaced, set **Startup Type** to **Manual** from **Properties** of the **EXPRESSCLUSTERServer** service.
4. Shut down all the servers connected to the shared disk to be replaced, and power them off.
5. Power off the shared disk, and change the disk.
6. Power on the shared disk, and configure its settings.
 - If it is required to build a RAID again or to change the LAN configuration, use the setup tool provided with the shared disk. For details, see the manual provided with the shared disk.
7. Start only one server, create a partition by using Disk Management (On the **Start** menu, point to **Settings**, and click **Control Panel**. Double-click **Administrative Tools** and then **Computer Management**, and click **Disk Management**.), and set the drive letter as before replacing the disk. Even if the drive letter you want to assign is the same as the drive letter automatically assigned by the OS, manually assign the desired drive letter explicitly; for example, by deleting the OS assigned drive letter and then assigning the desired drive letter.

Note:

Controlling the access to the created partition is started upon its creation, so it cannot be formatted. Set only the drive letter here.

Note:

The size of the switchable partition used for disk resource can be changed in this occasion. The size of the data partitions of hybrid disk resource need to be the same in both server groups. Because of this, to change the size it is necessary to delete the resource, change the partition size in both server groups and then create the resource again.

Note:

If the OS in use is Windows Server 2008 R2 or later, changing or deleting the drive letter assigned to a partition of a shared disk may fail. To avoid this, specify the drive letter according to the procedure below:

- (1) Run the following command by using the command prompt to delete the drive letter.
`mountvol <drive_letter(to_be_changed)>: /P`
 - (2) Confirm that the drive letter has been deleted from the target drive by using Disk Management (**Control Panel** > **Administrative Tools** > **Computer Management** > **Disk Management**).
 - (3) Assign a new drive letter to the drive by using Disk Management.
-

8. To format the partition to be used as the disk resource, execute the following command to temporarily release the access restriction.

```
clpvolctrl --open <drive_letter_of_the_partition_to_be_used_as_the_disk_resource>
```

9. From disk management (**Control Panel** > **Administrative Tools** > **Computer Management** > **Disk Management**), format the partition to be used as the disk resource.

10. To restore the access restriction temporarily released in 8, above, execute the following command:

```
clpvolctrl --close  
<drive_letter_of_the_partition_to_be_used_as_the_disk_resource>
```

11. Start other servers connected to the replaced shared disk in the cluster, by using Disk Management (On the **Start** menu, point to **Settings**, and click **Control Panel**. Double-click **Administrative Tools** and then **Computer Management**, and click **Disk Management**.), and check that the partition created by the first server is visible.
12. Set the drive letter of the partition used for the disk resource in the same way as the first server.
13. Start the Builder online.
14. When there are partitions with no access restriction on the replaced shared disk, add these partitions in **Partition excluded from cluster management** by selecting the **HBA** tab of **Properties** and then clicking **Connect** in each server connected to the shared disk.

Note:

When **Partition excluded from cluster management** is set for the shared disk before replacement, delete the setting, and then make the setting again. Perform the following procedure.

- 14-1. Right-click the server that is connected to the replaced disk from the Builder, open the **HBA** tab of **Properties** and then click **Connect**.
- 14-2. Select an HBA for which filtering is checked and then execute **Remove** for all the partitions that are displayed in **Partition excluded from cluster management**.
- 14-3. Click **Add** again to add all the partitions deleted in step 14-2.
- 14-4. Make sure that **Volume**, **Disk No.**, **Partition No.**, **Size**, and **GUID** are displayed for each partition that is excluded from cluster management.
15. When some servers are operating as cluster, stop the cluster from the WebManager.
16. Select **Apply the Configuration File** from the **File** menu of the Builder, and apply the cluster configuration data to the cluster.
 - When the message “There is difference between the disk information in the configuration information and the disk information in the server. Are you sure you want automatic modification?” appears, select **Yes**.
17. On all servers connected to the replaced shared disk, re-configure **Startup Type** to **Automatic** from **Properties** of the **EXPRESSCLUSTERServer** service.
18. Start the WebManager, and start the cluster.
19. Format the partition used for the disk resource from the server on which the disk resource is running. In case the group with the disk resource is stopped, format the partition after starting the disk resource as necessary.
20. When there is a partition of the hybrid disk resource on the replaced shared disk, rebuilding of mirroring (full copy) is automatically performed if the **Auto mirror recovery** is configured in the **Mirror disk** tab of **Cluster Properties**. If the settings are configured not to perform **Auto mirror recovery**, reconfigure mirror manually.

Replacing the mirror disk

If an error occurs in a disk that forms a mirror set, follow the steps below to replace the disk. When using a disk array, the procedure below also needs to be performed if the array configuration is changed or a disk is recognized as a new one due to DAC replacement or some other reason.

You can replace a local disk mirrored by a hybrid disk resource by following the steps below. In that case, consider “mirror disk resource” in the description below as “hybrid disk resource”. To replace a shared disk that is mirrored by a hybrid disk resource consisting of three or more servers, see the procedure described in "Replacing the hybrid disk".

1. Make sure that the cluster is working properly. (However, ignore errors in the disk to be replaced.)
2. If the group is running on the server, which contains the disk to be replaced, move the group.
3. When the **Auto Mirror Recovery** check box is selected in **Properties** of the cluster, start the Builder on line, select **Properties** of the cluster and the **Mirror disk** tab, clear the **Auto Mirror Recovery** check box, select **Apply the Configuration File** in the **File** menu to apply the cluster configuration data to the cluster.
4. Shutdown the server whose disk is to be replaced from the WebManager and power it off.
5. Replace the disk and start the server.
6. Configure the settings for the disk by the server with the replaced disk.
 - Reserve the data partition and the cluster partition for the mirror disk by using Disk Management (On the **Start** menu, point to **Settings**, and click **Control Panel**. Double-click **Administrative Tools** and then **Computer Management**, and click **Disk Management**.) Set the drive letters of the data partition and the cluster partition so that the drive letters of data partition and cluster partition and the size of data partitions are the same in both servers.
7. When the **Auto Mirror Recovery** is configured as **Off** in the **Auto Recovery** tab in **Cluster properties**, return the replaced server to the cluster from the WebManager.
8. Suspend the cluster.
9. Start the Builder on line. If you have unchecked the **Auto Mirror Recovery** check box in procedure 3, check the **Auto Mirror Recovery** check box again.
10. Select **Apply the Configuration File** from the **File** menu of the Builder to upload the cluster configuration data to the cluster.
 - When the message “There is difference between the disk information in the configuration information and the disk information in the server. Are you sure you want automatic modification?” appears, select **Yes**.
11. Resume the cluster from the WebManager.
12. If the **Auto Mirror Recovery** check box is selected in cluster properties, full reconstruction of mirror will be performed. If not, it is required to perform the reconstruction manually.
13. Move the group as necessary.

Replacing the hybrid disk

In a hybrid disk resource environment consisting of three or more servers, if an error occurs in a shared disk that forms a mirror set, replace that disk by applying the procedure described below. When a disk array is used, the procedure below also needs to be performed if the configuration of the array is changed or a disk is recognized as being a new one due to DAC replacement or some other reason.

To replace a local disk that is mirrored by a hybrid disk resource, see the procedure in "Replacing the mirror disk".

1. Check that the cluster is working properly. (Ignore errors with the disk that is to be replaced.)
2. If the group is running on the server, which contains the disk to be replaced, move the group.
3. When the **Auto Mirror Recovery** check box is checked in **Properties** of the cluster, start the Builder online, select **Properties** of the cluster and the **Mirror disk** tab, uncheck the **Auto Mirror Recovery** check box, and then select **Apply the Configuration File** from the **File** menu to apply the cluster configuration data to the cluster.
4. Select **Service** and then **Stop** from the WebManager to execute cluster stop for all the servers connected to the shared disk to be replaced.
5. On all the servers connected to the shared disk to be replaced, set **Startup Type** to **Manual** for **EXPRESSCLUSTER Server** service.
6. Shut down all the servers connected to the shared disk to be replaced, and power them off.
7. Power off and replace the shared disk.
8. Power on the shared disk, and configure its settings.
 - If the RAID is to be built again or if the LUN configuration is to be changed, use the setup tool provided with the shared disk. For details, refer to the manual provided with the shared disk.
9. Start only one server, create a partition by using Disk Management (**Control Panel** > **Administrative Tools** > **Computer Management** > **Disk Management**) and set the drive letter as before replacing the disk. Even if the drive letter you want to assign is the same as the drive letter automatically assigned by the OS, manually assign the desired drive letter explicitly; for example, by deleting the OS assigned drive letter and then assigning the desired drive letter.

Note:

Controlling the access to the created partition is started upon its creation, so it cannot be formatted. Set only the drive letter here.

Note:

The size of the switchable partition used for a disk resource can be changed in this occasion. The sizes of the data partitions of a hybrid disk resource need to be the same in both server groups. For this reason, to change the size, it is necessary to delete the resource, change the partition size in both server groups and then create the resource again.

Note:

If the OS in use is Windows Server 2008 R2 or later, changing or deleting the drive letter assigned to a partition of a shared disk may fail. To avoid this, specify the drive letter according to the procedure below:

- (1) Run the following command by using the command prompt to delete the drive letter.
`mountvol <drive_letter(_to_be_changed)>: /P`
 - (2) Confirm that the drive letter has been deleted from the target drive by using Disk Management (**Control Panel** > **Administrative Tools** > **Computer Management** >
-

Disk Management).

(3) Assign a new drive letter to the drive by using Disk Management.

10. To format the partition to be used as a disk resource, execute the following command to temporarily release the access restriction:

```
clpvolctrl --open <drive_letter_of_partition_to_be_used_as_disk_resource>
```

11. From Disk Management (**Control Panel > Administrative Tools > Computer Management > Disk Management**), format the partition to be used as a disk resource.
12. To restore the access restriction temporarily released in step 10 above, execute the following command:
- ```
clpvolctrl --close <drive_letter_of_partition_to_be_used_as_disk_resource>
```
13. Start the other servers connected to the replaced shared disk, and check that the partition created on the first server is visible from Disk Management (**Control Panel > Administrative Tools > Computer Management > Disk Management**).
14. Set the drive letter for each partition on the shared disk in the same way as for the first server as before replacing the disk.
15. On all the servers connected to the replaced shared disk, restore **Startup Type** to **Automatic** for **EXPRESSCLUSTER Server** service.
16. Start the WebManager and select **Service**, then click **Start** to execute cluster start for all the servers connected to the replaced shared disk.

---

**Note:**

An hdw or hdtw warning message may be displayed at this time. Ignore the message and proceed to the next step.

---

17. Suspend the cluster.
18. When there are partitions with no access restrictions on the replaced shared disk, add these partitions to **Partition excluded from cluster management** by selecting the **HBA** tab of **Properties** and then clicking **Connect** for each server connected to the shared disk.

---

**Note:**

When **Partition excluded from cluster management** is set for the shared disk before replacement, delete the setting, and then make the setting again. Perform the following procedure.

---

- 18-1. Right-click the server that is connected to the replaced disk from the Builder, open the **HBA** tab of **Properties** and then click **Connect**.
- 18-2. Select an HBA for which filtering is checked and then execute **Remove** for all the partitions that are displayed in **Partition excluded from cluster management**.
- 18-3. Click **Add** again to add all the partitions deleted in step 18-2.
- 18-4. Make sure that **Volume**, **Disk No.**, **Partition No.**, **Size**, and **GUID** are displayed for each partition that is excluded from cluster management.
19. Start the Builder. If you have unchecked **Auto Mirror Recovery** in step 3, check it again.
20. Select **Apply the Configuration File** from the **File** menu of the Builder to apply the cluster configuration data to the cluster.
- When the pop-up message "There is difference between the disk information in the configuration information and the disk information in the server. Are you sure you want automatic modification?" appears, select **Yes**.
21. Resume the cluster from the WebManager.
22. If **Auto Mirror Recovery** is checked, full reconstruction (full copying) of the mirror set is performed automatically. Otherwise, manually reconstruct the mirror set.

23. Move the group as required.

## Increasing the shared disk size

First, expand the logical disk volume in the shared disk settings so that you can allocate enough free space for increasing the disk size immediately after the partition that is used by the disk resource.

The disk size can not be increased by using the free space of a disk other than the disk that includes the partition that you want to expand.

1. Make sure that the cluster is working properly.
2. Suspend all monitor resources by the using WebManager.
3. Shut down and power off all servers connected to the shared disk by using the WebManager, excluding the server on which the group is running.
4. Perform **Extend Volume** by using Disk Management (**Control Panel > Administrative Tools > Computer Management > Disk Management**) for the target drive on the server on which the group is running.
5. Start all servers that were shut down in step 3.
6. Check whether the drive letter of the expanded volume has been changed on all servers. If the drive letter has been changed, assign the previous drive letter.

---

**Note:**

If the OS in use is Windows Server 2008 R2 or later, changing or deleting the drive letter assigned to a partition of a shared disk may fail. To avoid this, specify the drive letter according to the procedure below:

- (1) Run the following command by using the command prompt to delete the drive letter.  
`mountvol <drive_letter(to_be_changed)>: /P`
- (2) Confirm that the drive letter has been deleted from the target drive by using Disk Management (**Control Panel > Administrative Tools > Computer Management > Disk Management**).
- (3) Assign a new drive letter to the drive by using Disk Management.

- 
7. Stop the group that includes the disk resource by using the WebManager.
  8. Suspend the cluster by using the WebManager.
  9. Select **Apply the Configuration File** from the **File** menu of the Builder to apply the cluster configuration data to the cluster.

---

**Note:**

When the pop-up message "There is difference between the disk information in the configuration information and the disk information in the server. Are you sure you want automatic modification?" appears, select **Yes**.

- 
10. Resume the cluster by using the WebManager.
  11. Start the group by using the WebManager.
  12. Move the group as required.

## Increasing the mirror disk size

First, allocate enough free space for increasing the disk size immediately after the partition that is used by the mirror disk resource.

The disk size can not be increased by using the free space of a disk other than the disk that includes the partition that you want to expand.

1. Make sure that the cluster is working properly.
2. Stop the group that includes the mirror disk resource to be expanded.
3. Start the Builder and delete the mirror disk resource to be expanded from the group. (If you want to expand multiple mirror disk resources, remove all of them from the group.)
4. If **Startup Attribute** is **Auto Startup** on the **Attribute** tab of **Properties** of the target group, change it to **Manual Startup**.
5. Select **Apply the Configuration File** from the **File** menu to apply the cluster configuration data to the cluster. If a message asking you to resume the cluster is displayed, select **Cancel**.
6. Expand the volume on both target servers of the mirror disk resource by using Disk Management (**Control Panel** > **Administrative Tools** > **Computer Management** > **Disk Management**).
7. After expanding the volume size, run the following command to confirm that the volume sizes of both target servers are the same.

```
clpvolsz <drive_letter_of_the_partition_to_be_used_as_the_disk_resource> :
```

8. Start the Builder and then recreate the mirror disk resources that were deleted in step 3.
9. Select **Apply the Configuration File** from the **File** menu of the Builder to apply the cluster configuration data to the cluster.
10. Resume the cluster by using the WebManager.
11. Start Mirror Disk Helper on the expanded mirror disk resource and perform a full copy assuming that the server with the latest data is the copy source.
12. Start the group and confirm that each mirror disk resource starts normally.
13. If **Startup Attribute** was changed from **Auto Startup** to **Manual Startup** in step 4, start the Builder and change this to **Auto Startup**. Then, select **Apply the Configuration File** from the **File** menu to apply the cluster configuration data to the cluster.
14. Move the group as required.

## Increasing the hybrid disk size

First, expand the logical disk volume in the shared disk settings so that you can allocate enough free space for increasing the disk size immediately after the partition that is used by the hybrid disk resource.

The disk size can not be increased by using the free space of a disk other than the disk that includes the partition that you want to expand.

1. Make sure that the cluster is working properly.
2. Stop the group that includes the hybrid disk resource to be expanded.
3. Start the Builder and delete the hybrid disk resource to be expanded from the group. (If you want to expand multiple hybrid disk resources, remove all of them from the group.)
4. If **Startup Attribute** is **Auto Startup** on the **Attribute** tab of **Group Properties**, change it to **Manual Startup**.
5. Select **Apply the Configuration File** from the **File** menu to apply the cluster configuration data to the cluster. If a message asking you to resume the cluster is displayed, select **Cancel**.
6. Select one server from each server group to be used as a work server.
7. Shut down all servers, excluding the work servers.
8. For work servers that use a shared disk as a hybrid disk resource, run the following command to allow access to the partition to be expanded. This step is not necessary for a work server that does not use a shared disk.

```
clpvolctrl --open <drive_letter_of_the_partition>
```

9. Expand the volume on both work servers by using Disk Management (**Control Panel > Administrative Tools > Computer Management > Disk Management**).
10. After expanding the volume size, run the following command to confirm that the volume sizes of all work servers are the same.

```
clpvolsz <drive_letter_of_the_partition>:
```

11. On both work servers, run the following command to prohibit access to the expanded partition. This step is not necessary for a work server for which step 8 has not been performed.

```
clpvolctrl --close <drive_letter_of_the_partition>
```

12. Start all servers, excluding the work servers.
13. Check whether the drive letter of the expanded volume has been changed on all servers. If the drive letter has been changed, assign the previous drive letter.

---

### Note:

If the OS in use is Windows Server 2008 R2 or later, changing or deleting the drive letter assigned to a partition of a shared disk may fail. To avoid this, specify the drive letter according to the procedure below:

- (1) Run the following command by using the command prompt to delete the drive letter.
 

```
mountvol <drive_letter(to_be_changed)>: /P
```
  - (2) Confirm that the drive letter has been deleted from the target drive by using Disk Management (**Control Panel > Administrative Tools > Computer Management > Disk Management**).
  - (3) Assign a new drive letter to the drive by using Disk Management.
-

14. Start the Builder and then recreate hybrid disk resources that have been deleted in step 3.
15. Select **Apply the Configuration File** from the **File** menu of the Builder to apply the cluster configuration data to the cluster.
16. Resume the cluster by using the WebManager. For servers other than the work servers, start the service individually.
17. Start Mirror Disk Helper on the expanded hybrid disk resource and perform full copy assuming that the server having the latest data is a copy source.
18. Start the group and confirm that each hybrid disk resource starts normally.
19. If **Startup Attribute** was changed from **Auto Startup** to **Manual Startup** in step 4, start the Builder and change this to **Auto Startup**. Then, select **Apply the Configuration File** from the **File** menu to apply the cluster configuration data to the cluster.
20. Move the group as required.



## Replacing the disk array controller (DAC)/updating the firmware

After the disk array controller (DAC) is replaced or the firmware is updated, the OS may recognize an existing disk as a new disk even if the disk has not been replaced actually. The required procedure varies depending on how the OS recognizes the disk. Therefore, be sure to perform the following procedure when replacing the DAC or updating the firmware.

1. Make sure that the cluster is working properly.
2. If a group is active on a server on which DAC is to be replaced or on which the firmware is to be updated (hereafter referred to as target server), move the group.
3. Before replacing the DAC or updating the firmware, execute the following command to check the combinations of "drive letter" and "GUID" for the partitions of all the mirror disk resources and hybrid disk resources.

```
mountvol
```

Output example:

```
C: > mountvol
Assumed values of current mount points and volume names:
 \\?\Volume{123da03a-e7e0-11e0-a2aa-806d6172696f}\
 C: \
 \\?\Volume{123da03b-e7e0-11e0-a2aa-806d6172696f}\
 Drive letter Z: \
 \\?\Volume{123da03c-e7e0-11e0-a2aa-806d6172696f}\
 P: \
 GUID
```

4. When replacing the DAC, shut down the target server from WebManager to power off.
5. Replace the DAC or update the firmware.  
When replacing the DAC, power on the target server to start the OS.
6. After the completion of DAC replacement or firmware update, perform the following procedure to check that the OS recognizes the disk used by the mirror disk resources and hybrid disk resources as an existing disk.  
Execute the following command on the target server to check whether the combinations of "drive letter" and "GUID" for the mirror disk resources and hybrid disk resources have changed from those checked in step 3.

```
mountvol
```

7. When the combinations of "drive letter" and "GUID" for all mirror disk resources and hybrid disk resources have not changed from those checked in step 3, the disk is recognized as an existing disk by the OS. In this case, execute step 10 and subsequent steps. (Steps 8 and 9 are not required.)  
When the combination has changed from that checked in step 3, the disk is recognized as a new disk by the OS. In this case, execute step 8 and subsequent steps.
8. Check the disk setting on the target server.
  - Check the drive letters of the data and cluster partitions using Disk Management (**Control Panel -> Administrative Tools -> Computer Management -> Disk Management**). If the drive letter has been changed, re-configure it as it was, restart the server and check that the drive letter is configured correctly.
9. Restart the target server from WebManager.

- If the drive letters are corrected in step 8 above, reconfigure the cluster information according to the procedures in steps 7 to 11 of “Replacing the mirror disk”. In this case, read “server on which disks were replaced” as “target server”.
10. Recover the target server to the cluster.
    - In automatic recovery mode, the server is automatically recovered to the cluster.
  11. If **Cluster Properties** -> **Mirror Disk** tab -> **Auto Mirror Recovery** is set, the mirror is automatically reconstructed (partially copy or full copy). If the settings are configured not to perform **Auto Mirror Recovery**, reconstruct the mirror manually.
    - If mirror reconstruction ends abnormally, reconfigure the cluster information according to the procedures in steps 8 to 12 of “Replacing the mirror disk”. In this case, read “server on which disks were replaced” as “target server”.
  12. Move the group as required.

## Replacing FibreChannel HBA / SCSI / SAS controller

Follow the procedures below to replace HBA connecting the shared disk.

1. If the group is operating in the server where HBA is to be replaced (hereafter referred to as target server), move the group to another server.
2. Change the settings for the EXPRESSCLUSTER Server service of the target server to manual start.
3. Shut down the target server to replace HBA.
4. Start the target server with the disk cable disconnected.
5. Start the Builder online, open the properties of the target server and configure filter settings on the replaced HBA.
  - Click **Connect** on the **HBA** tab to acquire the disk configuration data for the target server, and then select the replaced HBA.
  - Do not change the settings other than above.
6. Save the cluster configuration data in which HBA filter setting has been configured in Builder temporarily in the disk area accessible from the cluster server.
  - If the Builder is used on the cluster server, save the cluster configuration data in the local disk. Also, if the Builder is used on another PC, save it in the shared folder accessible from the cluster server, or save it temporarily in an external media disk etc. and then copy it to the local disk of the cluster server.
7. Execute the following command on one of the cluster servers to upload the saved cluster configuration data.

```
clpcfctrl --push -x <
path_of_the_cluster_configuration_information> --nocheck
```
8. Shut down the target server and connect the disk cable.
9. Start the target server to check the drive letter in **Disk Management**. If the drive letter has been changed, set it as it was before. Restart the server to check that the drive letter is correctly configured.
10. Start the Builder online and open the properties of the target server to check the settings for the **HBA** tab. If there is a partition which does not restrict access on the shared disk, check that the partition data is registered in **Partition excluded from cluster management**.
11. As with the steps 6 and 7 above, save the cluster configuration data temporarily and upload it from the cluster server with the following command:

```
clpcfctrl --push -x <
path_of_the_cluster_configuration_information> --nocheck
```
12. Set the configuration for the EXPRESSCLUSTER Server service of the target server back to automatic start, and reboot the target server.
13. When **Auto Recovery** is configured as **Off** in **Properties** of the cluster, right-click the target server in WebManager to select **Recover**.
14. Migrate the group if necessary.

## Information required for inquiry

The following information is required for inquiring about the failure.

1. Failure  
Describe the failure.  
Example) Failover group (failover1) failed to fail over from server1 to server2.
2. Time that the failure occurred  
Example) 2014/01/01 00:00
3. Name of the server with the failure  
Example) server2
4. Version of EXPRESSCLUSTER  
Example) EXPRESSCLUSTER X 3.3
5. EXPRESSCLUSTER log and event log of when the failure occurred  
Logs can be collected by using the WebManager or by running the log collection command. To use the WebManager, see “Collecting logs by using the WebManager” in Chapter 1, “Functions of the WebManager” in this guide. To use the log collection command, see “Collecting logs (clplogcc command)” in Chapter 3, “EXPRESSCLUSTER command reference” in this guide.

# Chapter 11 Troubleshooting

This chapter provides instructions for troubleshooting problems with EXPRESSCLUSTER.

This chapter covers:

- Troubleshooting ..... 1178
- When the EXPRESSCLUSTER system does not start or end ..... 1178
- When activating or deactivating network partition resolution resource fails ..... 1179
- When a network partition resolution resource error is detected ..... 1179
- When activating or deactivating group resources fails ..... 1180
- When a monitor resource error occurs ..... 1180
- When a heartbeat timeout occurs ..... 1180
- Recovering from failure of one server ..... 1180
- Recovering from failure of both servers ..... 1180
- When network partitioning occurs ..... 1181
- Unavailable commands when interconnections are disconnected ..... 1184
- Connecting mirror disks/hybrid disks manually ..... 1185
- Normally connecting mirror disk when mirroring is available ..... 1185
- Forcibly connecting mirror disk when mirroring is not available ..... 1185
- Recovering from mirror breaks ..... 1186
- Automatically recovering from mirroring ..... 1187
- Checking the mirror break status with a command ..... 1188
- Checking the mirror recovery progress with a command ..... 1189
- Recovering mirror with a command ..... 1190
- Running the forcible mirror recovery with a command ..... 1190
- Running the forcible mirror recovery with a command only on one server ..... 1192
- Checking the mirror break status from the WebManager ..... 1193
- Checking the mirror recovery progress from the WebManager ..... 1194
- Recovering mirror using the WebManager ..... 1196
- Running the forcible mirror recovery using the WebManager ..... 1197
- Running the forcible mirror recovery from the WebManager only on one server ..... 1198
- Media sense function becomes invalid ..... 1198

## Troubleshooting

The following provides instructions for troubleshooting problems you experience in operating the EXPRESSCLUSTER system.

### When the EXPRESSCLUSTER system does not start or end

A cluster system starts working by restarting servers after installing EXPRESSCLUSTER. If your cluster system does not behave properly, check the following:

1. Registration of cluster configuration data

The cluster configuration data should be registered with all servers (which will form a cluster system) when you cluster them. Make sure that the cluster configuration data is uploaded on all the servers.

For details, see Chapter 5, “Creating the cluster configuration data” in the *Installation and Configuration Guide* for registering the data.

2. Server names and IP addresses in the cluster configuration data

Check the server names and IP addresses are valid.  
(>hostname, >ipconfig....)

3. License registration

The license may not be registered yet. Run the license manager on all servers in the cluster to confirm that the license is registered:

If you are using the trial version license, confirm if it is not expired yet.

To run the license manager, select **EXPRESSCLUSTER Server** from the **Start** menu, and then **License Manager**.

4. EXPRESSCLUSTER service

Start the service control manager of the OS, and make sure that the following EXPRESSCLUSTER services have been started. If all of them have been started, EXPRESSCLUSTER is running normally. To run the service control manager, from **Control Panel**, select **Administrative Tools** and select **Services**.

EXPRESSCLUSTER  
EXPRESSCLUSTERDisk Agent  
EXPRESSCLUSTEREvent  
EXPRESSCLUSTERManager  
EXPRESSCLUSTEROld API Support  
EXPRESSCLUSTERServer  
EXPRESSCLUSTERTransaction  
EXPRESSCLUSTERWeb Alert

5. Free disk space

Run [Disk Management] to check the size of the free disk space in the drive that contains <EXPRESSCLUSTER\_installation\_path>. For details on the disk space to be used by EXPRESSCLUSTER, see Chapter 3, “Installation requirements for EXPRESSCLUSTER” in *Getting Started Guide*. To run Disk Management, select **Control Panel**, select **Administrative Tools**, and select **Computer Management**. Then from the icon tree, select **Services** under **Services and Applications**.

6. Usage of memory or OS resource

Run Task Manager of the OS to check the OS memory usage and CPU usage rate.

## When activating or deactivating network partition resolution resource fails

1. Majority method  
Memory or OS resources may not be sufficient. Check them.
2. COM method  
The cause may be one of the following:
  - The specified device name (such as COM1 and COM2) may not exist in the system. Confirm that the device name specified by the Builder exists in the system.
  - Other application may be using the device name specified by the Builder (such as COM1 and COM2). Check the device name.
3. PING method  
Memory or OS resources may not be sufficient. Check them.
4. DISK method  
The settings of the Builder are invalid. Check that the disk heartbeat partition is set to be filtered on the **HBA** tab of **Server Properties** of the server that failed to be activated or deactivated. Check that the disk heartbeat partition is not used by other resource (disk resource, mirror disk resource).

## When a network partition resolution resource error is detected

1. Majority method  
Memory or OS resources may not be sufficient. Check them.
2. COM method  
Communication between the servers by the COM method cannot be performed. Confirm that the serial cable is connected to the device specified by the Builder properly.
3. PING method  
There is no PING command response from the PING destination device. Check that there is no problem in the communication path from the cluster server to the PING destination device.
4. DISK method  
Timeout occurred in accessing the disk heartbeat partition, or disconnection of the cable to the shared disk was detected.  
  
If a timeout has occurred, select **Cluster Properties** → disk network partition resolution resource in which the error occurred from the **NP Resolution** tab, and then open **Properties**. Adjust **IO Wait Time** in the **Disk NP Properties** dialog.  
  
If cable disconnection is detected, check the cable connection status.

## When activating or deactivating group resources fails

If any error is detected in activation of a group resource, detailed error information is logged in the alert and event log. See “Detailed information in activating and deactivating group resources” and examine the logs to find the cause of the error and take appropriate action for it.

## When a monitor resource error occurs

If a monitor resource detects any error, detailed information on error is logged in the alert and event logs. From the information, see “Detailed information of monitor resource errors” on page 1258, and examine the logs to find the cause of the error and take appropriate action for it.

## When a heartbeat timeout occurs

Possible causes of heartbeat timeout between servers are listed below:

| Cause                       | Solution                                               |
|-----------------------------|--------------------------------------------------------|
| Disconnection of LAN cables | Check that you can send packets with the ping command. |

## Recovering from failure of one server

If the automatic recovery mode is not set in **Cluster Properties**, the server that you have removed errors and restarted is in the **Suspension (Isolated)** status. To recover the server to the normally functioning cluster from this status, use the WebManager or the clpcl command.

If the Replicator is used, data between the disks that form a mirror set becomes inconsistent. However, by recovering the server, the mirror will be automatically rebuilt, and the data will become consistent.

To recover the server by using the WebManager, see “Operating a cluster by using the WebManager Recovering servers” in Chapter 1, “Functions of the WebManager” in this guide.

To recover the server by using the clpcl command, see “Operating the cluster (clpcl command)” in Chapter 3, “EXPRESSCLUSTER command reference” in this guide.

## Recovering from failure of both servers

When **Off** is selected for **Auto Return** on the **Auto Recovery** tab in **Cluster Properties**, when all the servers shut down by failures such as a hardware failure, after starting them up, they are removed from the cluster. Recover all the servers by using the WebManager or the clpcl command.

Right after recovering the servers, all the groups are stopped. Start all the groups. If the Replicator is used, the mirror will be automatically built again by starting the groups, and the data will become consistent.



## When network partitioning occurs

Network partitioning indicates that all communication routes are blocked between servers. This section describes how you can check whether or not the network is partitioned and what you should do about it when the network partition resolution resource is not registered. The following examples assume that you have registered kernel mode LAN heartbeat resources for heartbeat resources in a 2-node cluster configuration.

When all heartbeat resources are normal (the network is not partitioned), the result of executing the `clpstat` command is:

### When you run the command on server1

```
clpstat -n

===== HEARTBEAT RESOURCE STATUS =====
Cluster : cluster
 *server0 : server1
 server1 : server2

HB0 : lanhb1
HB1 : lanhb2

[on server0 : Online]
 HB 0 1

server0 : o o
server1 : o o

[on server1 : Online]
 HB 0 1

server0 : o o
server1 : o o
```

### When you run the command on server2

```
clpstat -n

===== HEARTBEAT RESOURCE STATUS =====
Cluster : cluster
 server0 : server1
 *server1 : server2

HB0 : lanhb1
HB1 : lanhb2

[on server0 : Online]
 HB 0 1

server0 : o o
server1 : o o

[on server1 : Online]
 HB 0 1
```

```

server0 : o o
server1 : o o
=====
```

When the network is partitioned, the result of executing the clpstat command is what is described below. Both servers recognize each other that the counterpart is down.

#### When you run the command on server1

```
clpstat -n
```

```
===== HEARTBEAT RESOURCE STATUS =====
Cluster : cluster
*server0 : server1
server1 : server2

HB0 : lanhb1
HB1 : lanhb2

[on server0 : Caution]
HB 0 1

```

```
server0 : o o
server1 : x x
```

```
[on server1 : Offline]
HB 0 1

```

```
server0 : - -
server1 : - -
=====
```

#### When you run the command on server2

```
clpstat -n
```

```
===== HEARTBEAT RESOURCE STATUS =====
Cluster : cluster
server0 : server1
*server1 : server2

HB0 : lanhb1
HB1 : lanhb2

[on server0 : Offline]
HB 0 1

```

```
server0 : - -
server1 : - -
```

```
[on server1 : Caution]
HB 0 1 2

```

```
server0 : x x
server1 : o o
```

=====

Shut down both servers immediately if the network is partitioned. Check the following for heartbeat resources.

**21. Kernel mode LAN heartbeat resource**

- LAN cable status
- Network interface status

If interconnection LAN is recovered from the network partitioning, EXPRESSCLUSTER causes the servers to shut down.

If EXPRESSCLUSTER detects that the same group is active on multiple servers, it causes the servers to shut down.

For the Replicator, depending on the server shutdown timing, the statuses of mirror disk resources may not be the same after rebooting the server.

Depending on the timing of server shutdown, the status of mirror disk resources may be the one requiring forced mirror recovery, mirror recovery, or normal.

## Unavailable commands when interconnections are disconnected

| Commands for cluster construction                             |                                                                                                                                                                                                               |                                                                         |
|---------------------------------------------------------------|---------------------------------------------------------------------------------------------------------------------------------------------------------------------------------------------------------------|-------------------------------------------------------------------------|
| Command                                                       | Description                                                                                                                                                                                                   | Remarks                                                                 |
| clpcfctrl                                                     | Distributes the configuration information created by the Builder to the servers registered in the configuration information.<br><br>Backs up the cluster configuration information to be used by the Builder. | The configuration information cannot be distributed to other servers.   |
| Commands for showing status                                   |                                                                                                                                                                                                               |                                                                         |
| Command                                                       | Description                                                                                                                                                                                                   | Remarks                                                                 |
| clpstat                                                       | Displays the cluster status and settings information.                                                                                                                                                         | Statuses of other servers cannot be retrieved.                          |
| Commands for cluster operation                                |                                                                                                                                                                                                               |                                                                         |
| Command                                                       | Description                                                                                                                                                                                                   | Remarks                                                                 |
| clpcl                                                         | Starts, stops, suspends and resumes the EXPRESSCLUSTER Server service.                                                                                                                                        | Other servers cannot be operated, suspended or resumed.                 |
| clpdown                                                       | Stops the EXPRESSCLUSTER service and shuts down a server registered in the configuration information.                                                                                                         | Other servers cannot be operated.                                       |
| clpstdn                                                       | Stops the EXPRESSCLUSTER service in the entire cluster, and shuts down all servers.                                                                                                                           | Other servers cannot be operated.                                       |
| clpgrp                                                        | Starts, stops and moves groups.<br><br>Migrates virtual machines.                                                                                                                                             | Only groups on the local server can be stopped.                         |
| clptoratio                                                    | Extends and displays timeout values of all servers in the cluster.                                                                                                                                            | Timeout ratios of other servers cannot be set.                          |
| clprexec                                                      | Issues a request to execute the error correction action from the external monitor.                                                                                                                            | Some error correction actions cannot be executed on the local server.   |
| Commands for logs                                             |                                                                                                                                                                                                               |                                                                         |
| Command                                                       | Description                                                                                                                                                                                                   | Remarks                                                                 |
| clplogcc                                                      | Collects logs and OS information.                                                                                                                                                                             | Logs of other servers cannot be collected.                              |
| Commands for mirror (only for the Replicator / Replicator DR) |                                                                                                                                                                                                               |                                                                         |
| Command                                                       | Description                                                                                                                                                                                                   | Remarks                                                                 |
| clpmdstat                                                     | Displays the status and settings information of mirroring                                                                                                                                                     | The mirror status of the other servers cannot be retrieved.             |
| clpmdctrl                                                     | Activates/inactivates mirror disk resources and recovers mirroring.                                                                                                                                           | Mirror-related operations cannot be performed for other servers.        |
| clphdsnapshot                                                 | Controls snapshot backup of hybrid disk resource.                                                                                                                                                             | This command cannot be used unless mirroring is successfully performed. |
| clphdstat                                                     | Displays the status and settings information for mirroring of a hybrid disk resource.                                                                                                                         | The mirror status of the other servers cannot be retrieved.             |
| clphdctrl                                                     | Activates/deactivates hybrid disk resources and recovers mirroring.                                                                                                                                           | Mirror-related operations cannot be performed for other server groups.  |

## Connecting mirror disks/hybrid disks manually

This section describes how to cancel the access restriction for the data partition of mirror disk resource or hybrid disk resource when you cannot start EXPRESSCLUSTER due to some sort of failure.

### Normally connecting mirror disk when mirroring is available

When the EXPRESSCLUSTER Server service can be activated while the EXPRESSCLUSTER X Disk Agent service cannot be, access restriction can be canceled by following the steps below.

1. Run the following command on the server where you want to connect disks.

For mirror disks:

```
clpmdctrl --active <mirror_disk_resource_name (Example: md1)>
```

For hybrid disks:

```
clphdctrl --active <hybrid_disk_resource_name (Example: hd1)>
```

2. The mirror disk resource or hybrid disk resource becomes accessible. Written data is mirrored to the other server.

### Forcibly connecting mirror disk when mirroring is not available

Follow the steps below to save data on mirror disks when both the EXPRESSCLUSTER Server service and the EXPRESSCLUSTER X Disk Agent service cannot be activated.

However, the mirroring status up to the moment just before both the EXPRESSCLUSTER Server service and the EXPRESSCLUSTER X Disk Agent service became unable to be activated must be normal, or you must know which server has the latest data.

1. Uninstall EXPRESSCLUSTER from the server with the latest data, and restart the server.

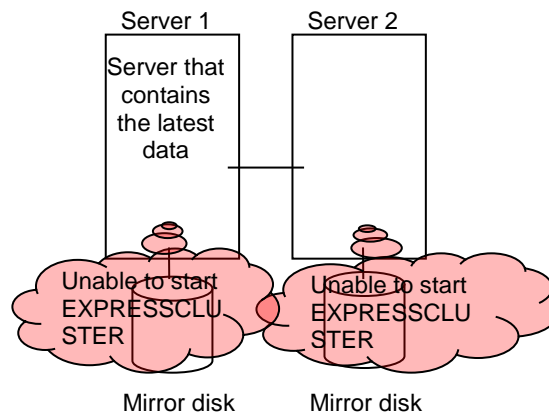

2. Back up the data in the data partition on a DAT tape or other media.

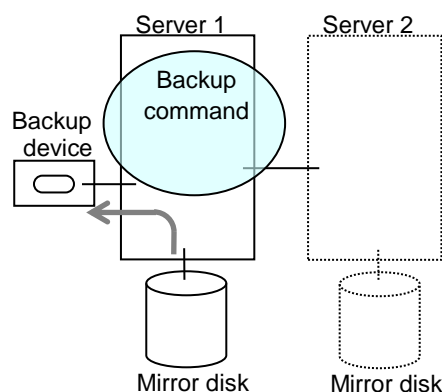

As for hybrid disk resources, if the above is performed while another server in the same server group is using the shared disk, the data on the shared disk may be destroyed. Make sure to stop the other server or disconnect the disk cable of the other server when you perform the above.

## Recovering from mirror breaks

When the auto-mirror recovery is enabled, no special operation is required. Mirroring is automatically recovered. However, if mirroring needs to be recovered forcibly, execution of a command or operations for forcible mirror recovery using the WebManager are required.

If the auto-mirror recovery is disabled, you have to recover mirroring by executing a command or using the WebManager.

The difference mirror recovery function is disabled and full copy is performed in the following cases:

- When the partition configuration for mirror disk resource or hybrid disk has been changed due to disk replacement etc.
- When both servers fail at the same time while mirror disk resource is normally activated
- When the current servers (servers updating and managing the disk in the server group) in the both server groups fail at the same time when the hybrid disk resource is normally activated
- When difference information could not be written successfully due to disk failure etc.

## Automatically recovering from mirroring

When the auto-mirror recovery is enabled, mirroring is automatically recovered under the following conditions:

1. Mirror disk resource or hybrid disk resource is active.
2. The server where mirror disk resource or hybrid disk resource is activated contains the latest data.
3. Servers in the cluster are in the normal status, and you can verify their mirroring statuses.
4. The data among the servers is not the same.
5. In case of mirror disk, both the mirror disk monitor resource and the mirror disk connect monitor resource must operate normally on all the registered servers.  
In case of hybrid disk, hybrid disk monitor resource must operate normally on a server that monitor target resource is activated.
6. Resource is not activated on a server/server group that does not store the latest data.
7. **Auto Mirror Recovery Setting** in the cluster's properties must be checked.  
However, if the initial mirror configuration is yet to be set, the initial mirror configuration must be checked in accordance with the above indicated.
8. Failures such as disk errors on the target disk of the mirror disk or hybrid disk are not occurring

The auto-mirror recovery is not performed if any of the following applies.

1. One of the servers (for hybrid disk resource, all servers in one of the server groups) is not started.
2. You cannot confirm the mirroring status of the other server.
3. There is no server whose mirror status is normal.
4. Mirror disk monitor resource or hybrid disk monitor resource is not registered.
5. Monitor resource is suspended or stopped in a server or server group that stores the latest data.
6. Resource is forcibly activated in other server or server group, including when snap shot backup is being executed.

For information on how to verify the progress of recovering mirroring, see “Checking the mirror recovery progress with a command” on page 1189 and “Checking the mirror recovery progress from the WebManager” on page 1194.

## Checking the mirror break status with a command

For mirror disk resources, run the following command to view the mirror break statuses.

```
clpmdstat --mirror <mirror_disk_resource_name (Example: md1)>
```

You can view the mirror disk resource statuses by running the clpmdstat command.

### 1. When normal:

```
Mirror Status: Normal
```

```
md1 server1 server2

Mirror Color GREEN GREEN
```

### 2. When the mirror recovery is required:

```
Mirror Status: Error
```

```
md1 server1 server2

Mirror Color GREEN RED
Lastupdate Time 2004/03/04 17:30:05 --
Break Time 2004/03/04 17:30:05 --
Disk Error OK OK
Difference Percent 1% --
```

### 3. When the forcible mirror recovery is required:

```
Mirror Status: Error
```

```
md1 server1 server2

Mirror Color RED RED
Lastupdate Time 2004/03/09 14:07:10 2004/03/09 13:41:34
Break Time 2004/03/09 14:06:21 2004/03/09 13:41:34
Disk Error OK OK
Difference Percent 1% 1%
```

### 4. While the mirroring is being recovered:

See “Checking the mirror recovery progress with a command” on page 1189.

For hybrid disk, execute the following command to check the mirror break status.

```
clphdstat --mirror <hybrid_disk_resource_name (Example: hd1)>
```



For details, see “Displaying the hybrid disk status (clphdstat command)” in Chapter 3, “EXPRESSCLUSTER command reference” in this guide.

## Checking the mirror recovery progress with a command

For mirror disk resources, run the following command to view the progress of recovering mirroring.

```
clpmdstat --mirror <mirror_disk_resource_name (Example: md1)>
```

You will see the following data while mirroring is being recovered.

```
Mirror Status: Recovering
```

```
md1 server1 server2
```

```

Mirror Color YELLOW YELLOW
```

```
Recovery Status Value
```

```

Status: Recovering
Direction: server1 -> server2
Percent: 7%
Used Time: 00:00:09
Remain Time: 00:01:59
```

You will see the following information when the mirror recovery is successfully completed.

```
Mirror Status: Normal
```

```
md1 server1 server2
```

```

Mirror Color GREEN GREEN
```

For hybrid disks, execute the following command to check the mirror break status.

```
clphdstat --mirror <hybrid_disk_resource_name (Example: hd1)>
```

For details, see “Displaying the hybrid disk status (clphdstat command)” in Chapter 3, “EXPRESSCLUSTER command reference” in this guide.

## Recovering mirror with a command

Run the following command to start the mirror recovery.

For mirror disk:

```
clpmdctrl --recovery <mirror_disk_resource_name (Example: md1)>
```

For hybrid disk:

```
clphdctrl --recovery <hybrid_disk_resource_name (Example: md1)>
```

When the difference mirror recovery can be performed, the difference data is used to recover the mirror (FastSync technology).

This command immediately returns the control once the mirror recovery starts. For information on how to verify the mirror recovery progress, see “Checking the mirror recovery progress with a command” on page 1189 and “Checking the mirror recovery progress from the WebManager” on page 1194.

## Running the forcible mirror recovery with a command

If EXPRESSCLUSTER cannot automatically determine which server contains the latest data, you have to run the forcible mirror recovery.

In this case, you have to manually identify the server that holds the latest data, and perform the forcible mirror recovery.

---

### Note:

The difference mirror recovery function is disabled in the forcible mirror recover, and the data may be fully copied.

---

Identify the server that holds the latest data by any of the following means:

- Using Mirror Disk Helper of the WebManager
  1. In the WebManager tree, right-click the mirror disk resource or hybrid disk resource you want to check and select **Detail information** to start Mirror Disk Helper.
  2. Click **Details**.
  3. See the last update time stamp (**Last Data Updated Time**) to identify the server which has the latest data. However, this **Last Data Updated Time** depends on the operating system's clock.

- Using the clpmdstat / clphdstat command

You can identify the server which has the latest data by using the following commands.

1. Run the following command.

For mirror disks:

```
clpmdstat --mirror <mirror_disk_resource_name (Example: md1)>
```

For hybrid disks:

```
clphdstat --mirror <hybrid_disk_resource_name (Example: hd1)>
```

2. See the last update time stamp (Last Data Updated Time) to identify the server which has the latest data. However, this Last Data Updated Time depends on the operating system's clock.

- Using data on disks

---

**Note:**

This method is not recommended because the data may be damaged if anything goes wrong in the procedure. Use the procedure described in "Using Mirror Disk Helper of the WebManager" or "Using the clpmdstat/clphdstat command" above when possible.

---

For mirror disks:

1. Confirm all groups are stopped.
2. Run the following command to connect the mirror disk resource.  
`clpmdopen <mirror_disk_resource_name (Example: md1)>`
3. Logically examine the data on the connection destination.
4. Run the following command to disconnect the mirror disk resource.
5. `clpmdclose <mirror_disk_resource_name (Example: md1)>`

For hybrid disks:

1. Confirm all groups are stopped.
2. Run the following command to connect the hybrid disk resource.  
`clphdctrl --active <hybrid_disk_resource_name (Example:hd1)> -f`
3. Logically examine the data on the connection destination.
4. Run the following command to disconnect the hybrid disk resource.  
`clphdctrl --deactive <hybrid_disk_resource_name (Example:hd1)>`

When you have identified the server holding the latest data, run the following command to start the forcible mirror recovery.

For mirror disks:

```
clpmdctrl --force <server_containing_the_latest_data>
<mirror_disk_resource_name (Example: md1)>
```

For hybrid disks (conducted on the server having the latest data):

```
clphdctrl --force <hybrid_disk_resource_name (Example:hd1)>
```

---

**Note:**

The `clpmdctrl --force` command performs mirror recovery from the specified server that has the latest data. The `clphdctrl --force` command updates the data on the server on which it is executed. For a hybrid disk resource, after executing this step, perform mirror recovery manually.

---

The `clpmdctrl / clphdctrl` command immediately returns the control once the forcible mirror recovery starts. For information on how to check the forcible mirror recovery progress, see "Checking the mirror recovery progress with a command" on page 1189 and "Checking the mirror recovery progress from the WebManager" on page 1194.

When the forcible mirror recovery is successfully completed, activate the groups. The mirror disks become available.

## Running the forcible mirror recovery with a command only on one server

In some cases, you cannot start one of the servers due to a hardware or OS failure, and the server that can be started may not have the latest data. If you want to start applications at least on the server that can be started, you can perform the forcible mirror recovery on that server.

However, remember that if you do this, the data on the server where you run this command becomes the latest data no matter which server actually has it. Therefore, even if you are able to start the other server later, you cannot handle the data in that server as the latest one. Make sure you understand the consequence before running the following command.

For mirror disk resources, use the WebManager to run forcible mirror recovery on one server only. See the procedure described in "Running the forcible mirror recovery from the WebManager only on one server".

For hybrid disk resources, execute the following command on the target server to start forcible mirror recovery.

```
clphdctrl --force <hybrid_disk_resource_name (Example:hd1)>
```

After executing the command, it becomes possible to start the group to use the hybrid disk.

## Checking the mirror break status from the WebManager

You can see the mirror break status by starting Mirror Disk Helper from the WebManager.

- When normal:

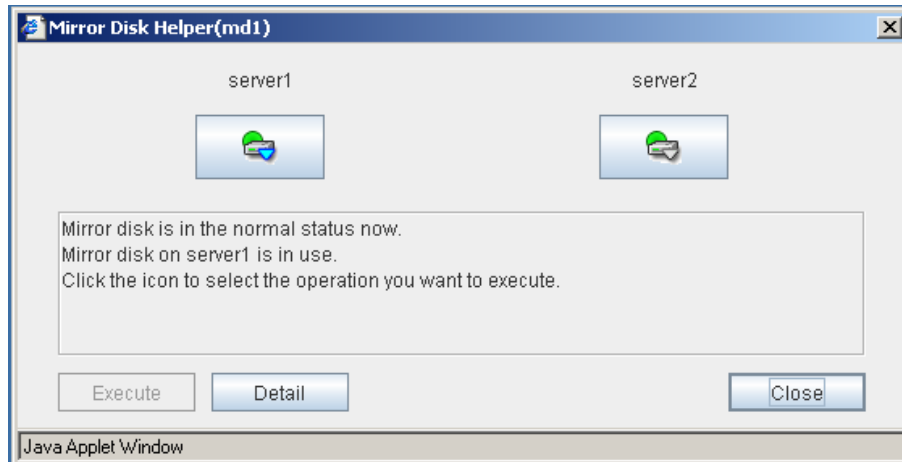

- When mirror recovery is required:

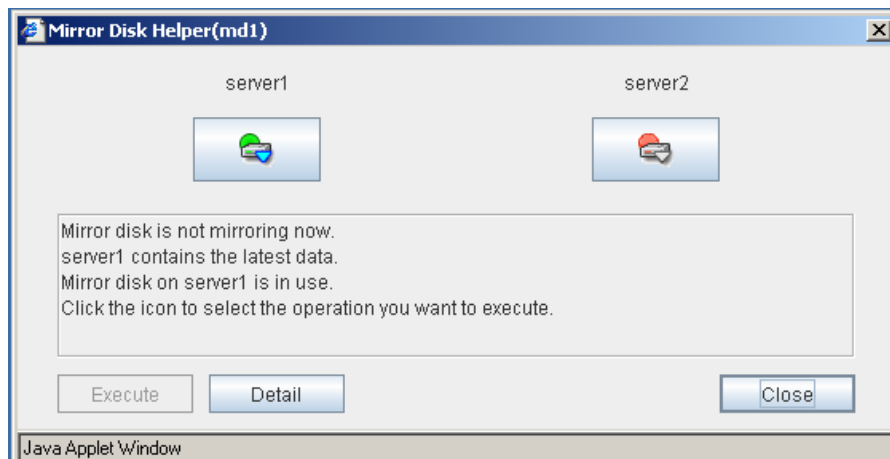

- When forcible mirror recovery is required:

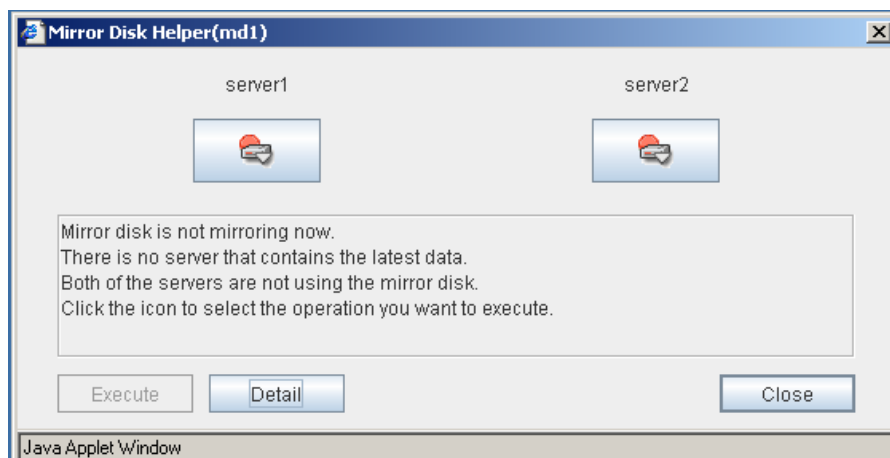

- While mirror recovery is in progress:

See “Checking the mirror recovery progress from the WebManager” on page 1193.

## Checking the mirror recovery progress from the WebManager

Start Mirror Disk Helper from the WebManager to view the mirror recovery progress.

You will see the following screen during the mirror recovery.

- For a mirror disk resource

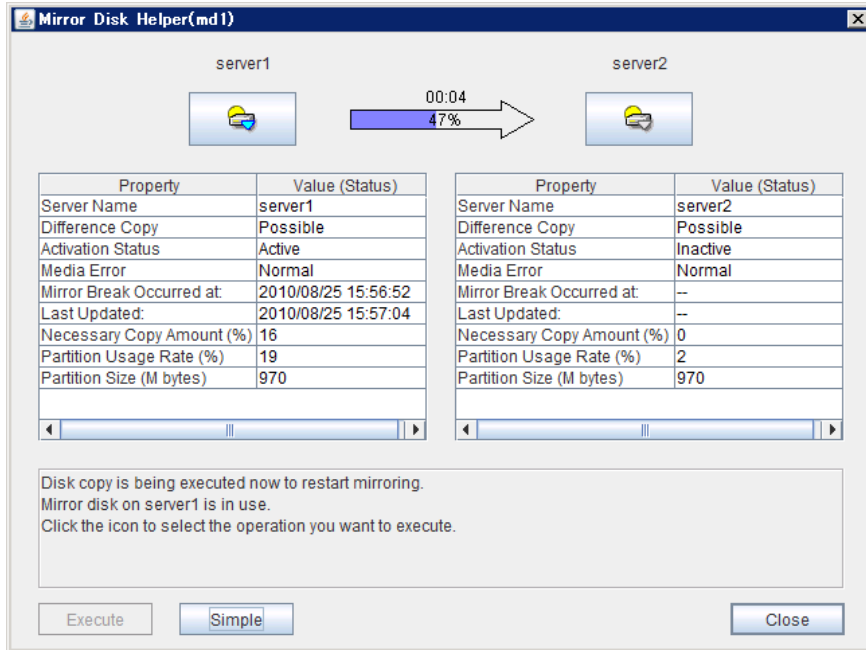

- For a hybrid disk resource

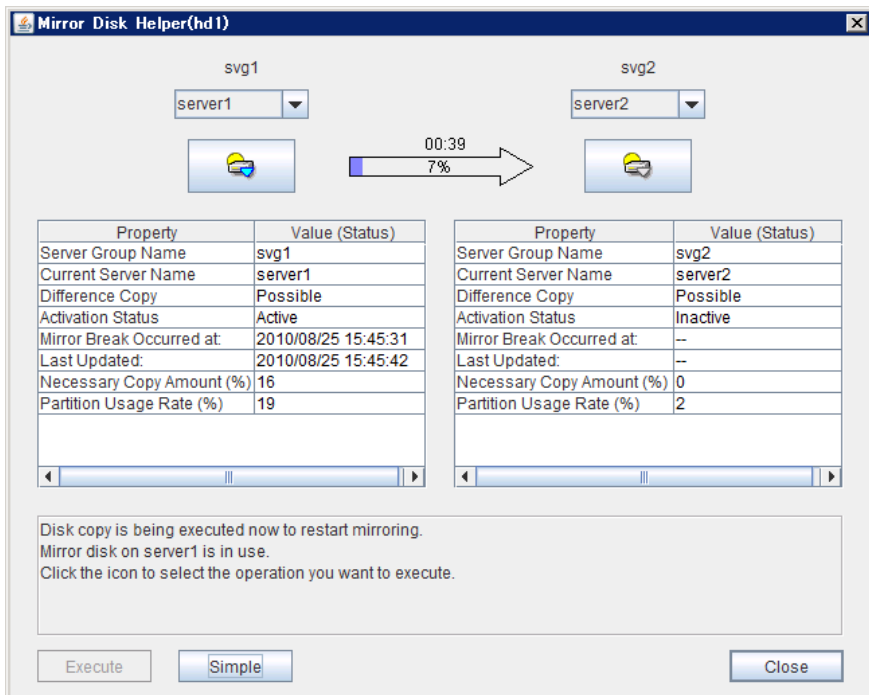

You will see the following screen when the mirror recovery is successfully completed.

- For a mirror disk resource

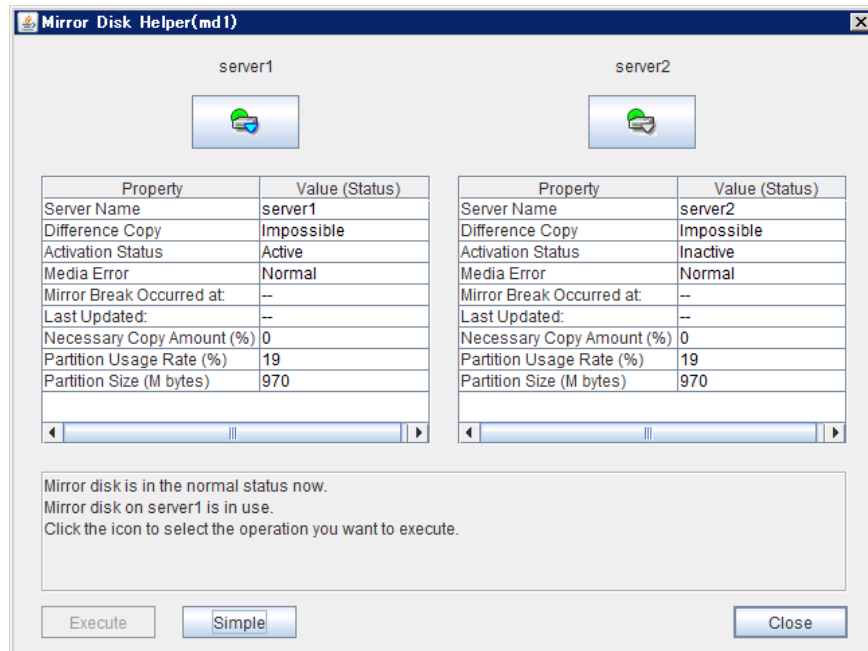

- For a hybrid disk resource

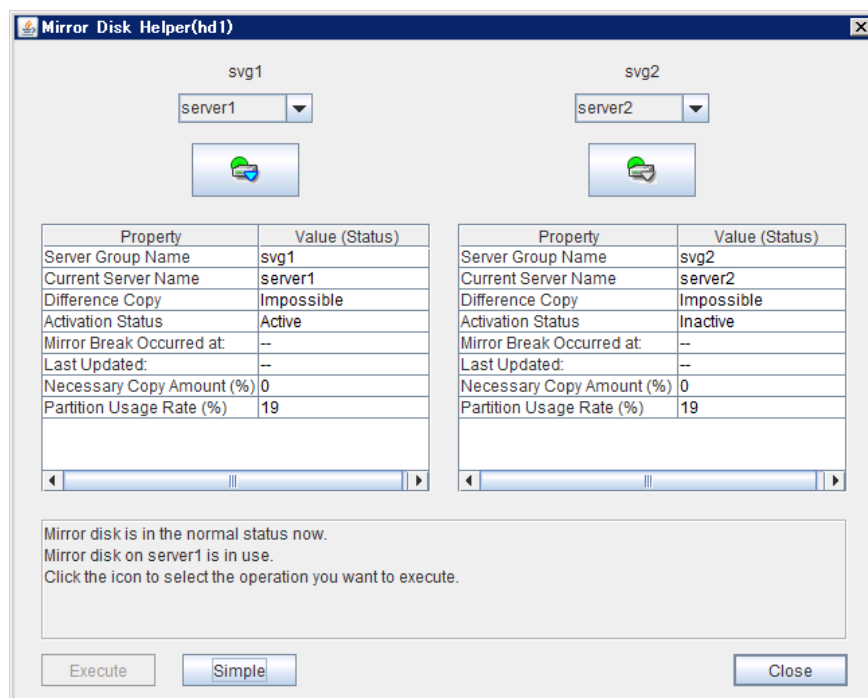

## Recovering mirror using the WebManager

Start Mirror Disk Helper from the WebManager to start mirror recovery. Click the icon of the server that needs to be recovered. The icon will be changed as in the window below. Click **Execute** to start the mirror recovery processing.

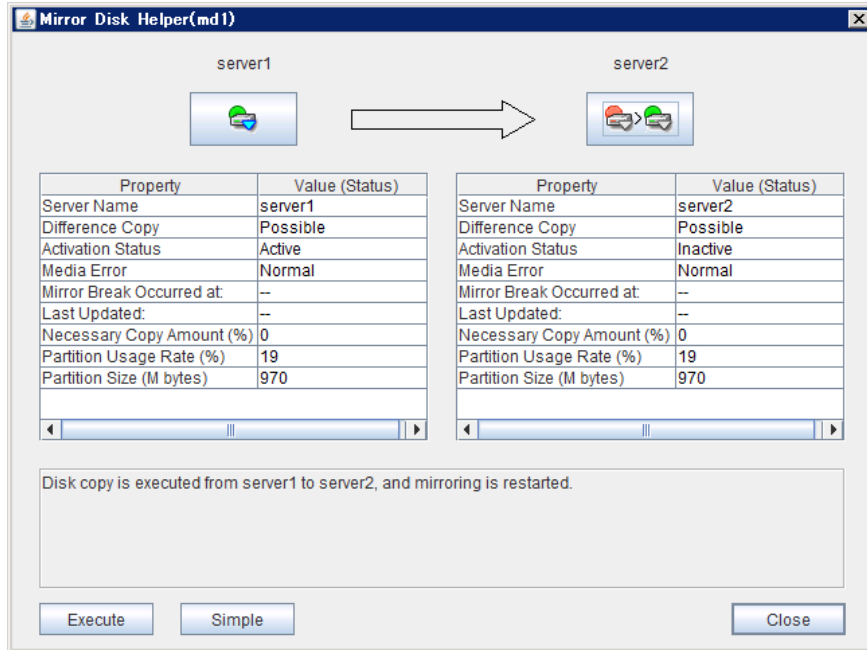

When the difference mirror recovery can be performed, the recovery is done using the difference data. (FastSync technology)The difference mirror recovery takes less time than the forcible mirror recovery.

For information on how to check the mirror recovery progress, see “Checking the mirror recovery progress with a command” on page 1189 and “Checking the mirror recovery progress from the WebManager” on page 1194.



## Running the forcible mirror recovery using the WebManager

When EXPRESSCLUSTER cannot determine which server has the latest data, you have to perform the forcible mirror recovery. In this case, you have to manually identify the server which holds the latest data, and perform the forcible mirror recovery.

The difference mirror recovery function is disabled in the forcible mirror recovery and the data may be fully copied.

Identify the server that has the latest data by any of the following methods:

- Using Mirror Disk Helper of the WebManager
  1. Right-click **Servers** in the WebManager tree to start the Mirror Disk Helper.
  2. On the main screen of Mirror Disk Helper, display the detailed data of the mirror disk resources you want to see.
  3. Click **Details**.
  4. See the last update time stamp (Last Data Updated Time) to identify the server which has the latest data. However, this Last Data Updated Time depends on the operating system's clock.

Select the icon of server containing the latest data. The icon will be changed as in the window below. Click **Execute** to start the mirror recovery processing.

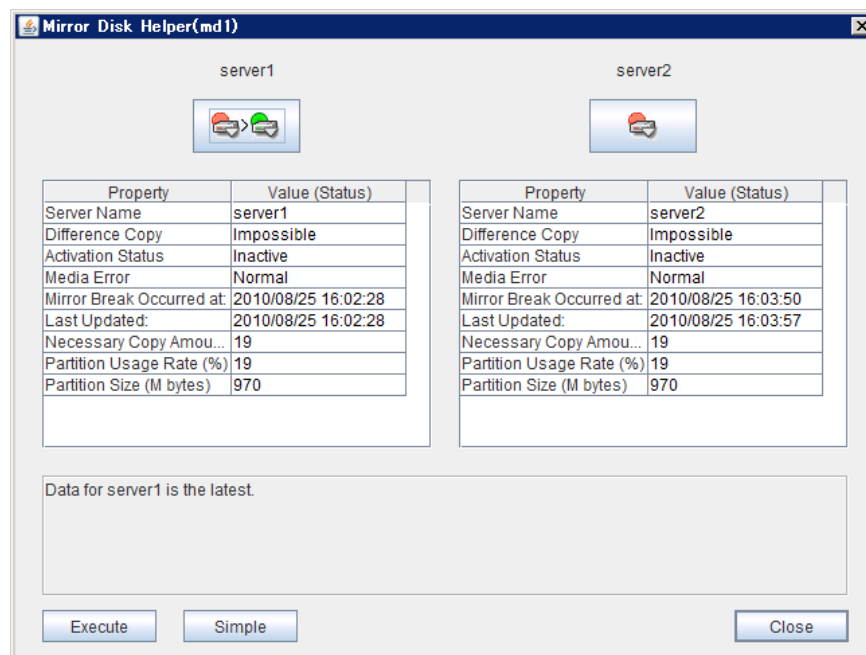

For information on how to check the forcible mirror recovery progress, see “Checking the mirror recovery progress with a command” on page 1189 and “Checking the mirror recovery progress from the WebManager” on page 1194.

When the forcible mirror recovery is successfully completed, you can activate the groups and use the mirror disks.

## Running the forcible mirror recovery from the WebManager only on one server

In some cases, you cannot start one of the servers due to a hardware or OS failure, and the server that can be started may not have the latest data. If you want to start applications at least on the server that can be started, you can perform the forcible mirror recovery on that server.

However, remember that if you do this, the data on the server where you run this command becomes the latest data no matter which server actually has it. Therefore, even if the other server becomes available later, you cannot handle the data in that server as the latest one. Make sure you understand the consequence before running the following command.

Start the Mirror Disk Helper from the WebManager to start the forcible mirror recovery. Select the icon of the server, which you want to perform the forcible mirror recovery. The icon will be changed as follows. Click **Execute** to perform the forcible mirror recovery processing.

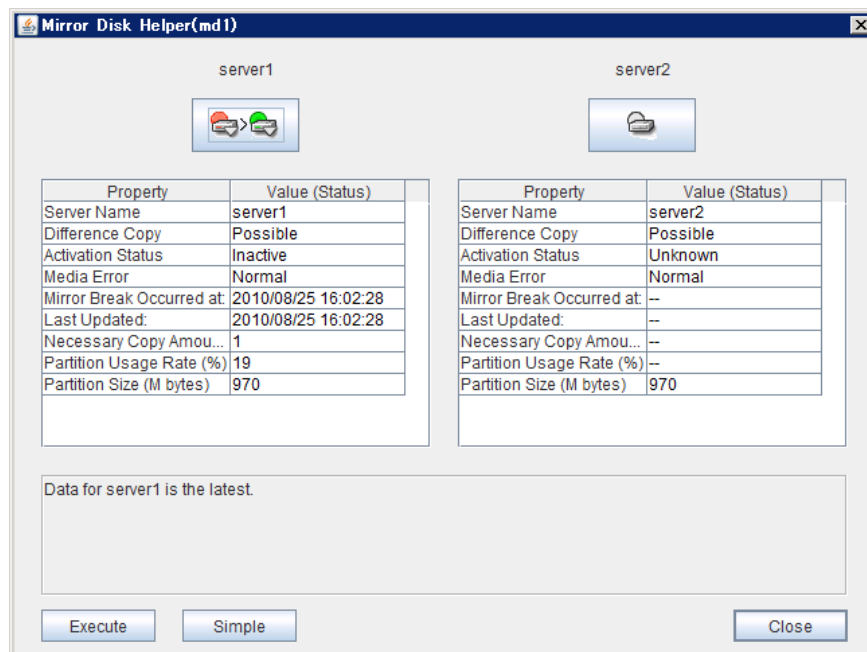

When the forcible mirror recovery is successfully completed, you can activate the groups and use the mirror disks.

## Media sense function becomes invalid

Media sense function is the OS function that detects disconnection of network cable. When disconnection is detected, TCP/IP receives a notification from the media sense function and renders the information such as an IP address assigned to the disconnected network card unavailable while it is disconnected. EXPRESSCLUSTER cannot be operated properly if the information such as IP address becomes invalid during its operation, so the media sense function is rendered invalid when installing EXPRESSCLUSTER.

# Chapter 12 Error messages

This chapter provides information on error messages you might encounter in operating EXPRESSCLUSTER.

This chapter covers:

- Messages ..... 1200
- Messages during setup..... 1200
- Messages reported by event log and alert ..... 1201
- Driver event log messages ..... 1240
- Detailed information in activating and deactivating group resources ..... 1244
- Detailed information of monitor resource errors ..... 1258
- STOP codes list of disk RW monitor resources ..... 1292
- Filter driver STOP code list..... 1292
- JVM monitor resource log output messages ..... 1293
- STOP codes list of user space monitor resources ..... 1305

## Messages

### Messages during setup

| Module Type | Error Message                                                                                                                                                         | Solution                                                                                                                                                                                                                                                                                               |
|-------------|-----------------------------------------------------------------------------------------------------------------------------------------------------------------------|--------------------------------------------------------------------------------------------------------------------------------------------------------------------------------------------------------------------------------------------------------------------------------------------------------|
| setup       | Previous version of EXPRESSCLUSTER is installed. Upgrading from this version is not supported. Install after uninstalling the previous version of EXPRESSCLUSTER.     | Uninstall the previous version of EXPRESSCLUSTER, and then try installing again.                                                                                                                                                                                                                       |
| setup       | The SNMP service is running. You need to stop the SNMP service before you perform uninstallation. Do you want to stop the SNMP service now?                           | Select <b>Yes</b> to stop the SNMP service automatically and continue the installation. Or, select <b>No</b> to cancel the installation, manually stop the SNMP service and then perform installation again.                                                                                           |
| setup       | Setup has failed.<br>Error code : xxx                                                                                                                                 | <ul style="list-style-type: none"> <li>- Check the system requirements, setup procedures and notes described in the manual, and make sure they are followed.</li> <li>- If other application is running, terminate it.</li> <li>- Install again after restarting the OS.</li> </ul>                    |
| setup       | Setup has failed(xxx).<br>Error code : xxx<br>Please reboot the system and try again.                                                                                 | <ul style="list-style-type: none"> <li>- Check the system requirements, setup procedures and notes described in the manual, and make sure these requirements are followed.</li> <li>- If other application is running, terminate it.</li> <li>- Install again after starting the OS again.</li> </ul>  |
| setup       | Unsupported environment.                                                                                                                                              | Install in the environment where the system requirements are met.                                                                                                                                                                                                                                      |
| setup       | Cannot perform uninstallation because there is one or more EXPRESSCLUSTER services still running. Stop all EXPRESSCLUSTER services before you restart uninstallation. | Stop all EXPRESSCLUSTER services, and then perform uninstallation.                                                                                                                                                                                                                                     |
| setup       | Failed to start the installer.<br>(errcode: xxx)                                                                                                                      | <ul style="list-style-type: none"> <li>- Check the system requirements, setup procedures and notes described in the manual, and make sure they are followed.</li> <li>- If other application is running, terminate it.</li> <li>- The installer file may be corrupted or missing. Check it.</li> </ul> |
| setup       | Internal error.<br>(xxx)                                                                                                                                              | <ul style="list-style-type: none"> <li>- Check the system requirements, setup procedures and notes described in the manual, and make sure they are followed.</li> <li>- If other application is running, terminate it.</li> </ul>                                                                      |

## Messages reported by event log and alert

These are the messages reported by applications, event logs, and alert viewer of the WebManager. Messages with ● in the columns of Alert, Eventlog and Userlog are recorded in each log. The following shows how to refer the logs:

| Log Name  | How to refer                                                                                                                                                                                                                                                                                                                                                                                                                                    | File Name                    |
|-----------|-------------------------------------------------------------------------------------------------------------------------------------------------------------------------------------------------------------------------------------------------------------------------------------------------------------------------------------------------------------------------------------------------------------------------------------------------|------------------------------|
| Alert     | Output to the Alert Viewer of the WebManager. Logs can be collected by using the log collection tool.                                                                                                                                                                                                                                                                                                                                           | alertlog.alt                 |
| Event log | Output to the Event Viewer (application log) of the OS. Collect logs by using the log collection tool. The source of the event is "EXPRESSCLUSTER X." Logs can be collected by using the log collection tool. Note because they are collected in the binary format with the file names in the right column, it is necessary to open the files using Event Viewer in the environment where EXPRESSCLUSTER is set up to refer to the information. | AppEvent.Evt<br>SysEvent.Evt |
| User log  | These are the logs with text format, in which detail information is recorded. They are output in the "userlog.{00 - 02}.log" file in the log folder of the logs collected by using the log collection tool.                                                                                                                                                                                                                                     | userlog.{00 - 02}.log        |

Messages with ● in the Mail Report column will be sent as e-mail by EXPRESSCLUSTER X Alert Service.

Messages with ● in the SNMP Trap column will be sent as SNMP trap.

"Report Settings" are settings of when linking to the ESMPRO Agent. In "Alive," the ESMPRO Agent performs the Alert report. In "Manager," alerts are output to the ESMPRO Agent. For details, see the manual of the ESMPRO Agent.

For Mail Alert and SNMP Trap sending, refer to "Alert service tab" in Chapter 2 "Functions of the Builder" and "Alert service" in Chapter 9 "Other monitor settings" in this guide.

| Module Type | Event Type  | Event ID | Messages                                                                                                                        | Description                                           | Solution                                                                                                                       | Alert | Event log | User log | Mail report | SNMP Trap | Report setting |         |   |
|-------------|-------------|----------|---------------------------------------------------------------------------------------------------------------------------------|-------------------------------------------------------|--------------------------------------------------------------------------------------------------------------------------------|-------|-----------|----------|-------------|-----------|----------------|---------|---|
|             |             |          |                                                                                                                                 |                                                       |                                                                                                                                |       |           |          |             |           | Alive          | Manager |   |
| nm          | Information | 1        | The server %1 has been started.                                                                                                 | Server up                                             | -                                                                                                                              | •     | •         |          |             |           |                |         |   |
| nm          | Information | 2        | The server %1 has been stopped.                                                                                                 | Server down                                           | Server down was detected. Remove the failures of the server and then return the server to the cluster.                         | •     | •         |          | •           | •         | •              | •       | • |
| nm          | Information | 3        | The resource %2 of the server %1 has been started.                                                                              | Resource up                                           | -                                                                                                                              |       |           | •        |             |           |                |         |   |
| nm          | Error       | 4        | The resource %2 of the server %1 has an error.                                                                                  | Resource abnormally                                   | An error of the resource was detected. Refer to the event logs of the appropriate resource.                                    |       |           | •        |             |           |                |         |   |
| nm          | Information | 5        | The resource %2 of the server %1 has been recovered to the normal status.                                                       | Resource recover                                      | -                                                                                                                              |       |           | •        |             |           |                |         |   |
| nm          | Error       | 6        | The resource %2 of the server %1 is unknown.                                                                                    | Resource unknown                                      | Check the cluster configuration data.                                                                                          | •     | •         |          |             |           |                |         | • |
| nm          | Error       | 7        | Network partition was detected. Shut down the server %1 to protect data.                                                        | Network partition detected                            | No heartbeat resources can be used. Make sure there is no error in the network adapter and the network is correctly connected. | •     | •         |          |             |           |                | •       | • |
| nm          | Error       | 8        | An error occurred while confirming the network partition. Shut down the server %1.                                              | It was not possible to check for a network partition. | Refer to the event logs to check whether an error has occurred in a resource.                                                  | •     | •         |          |             |           |                | •       | • |
| nm          | Error       | 9        | An error occurred in confirming the network partition. To avoid failover on multiple servers, the server %1 suspended failover. | Failover hold                                         | Refer to the event logs to check whether an error has occurred in a resource.                                                  | •     | •         |          |             |           |                | •       | • |
| nm          | Information | 10       | The server %1 canceled the pending failover.                                                                                    | Failover hold cancel                                  | -                                                                                                                              | •     | •         |          |             |           |                |         |   |
| nm          | Error       | 11       | Shut down the server %1. (reason:%2)                                                                                            | Server shutdown                                       | No heartbeat resources can be used. Make sure there is no error in the network adapter and the network is correctly connected. | •     | •         |          |             |           |                | •       | • |
| nm          | Error       | 12       | Cluster service will be stopped. (reason:%1)                                                                                    | Cluster service stopping                              | Check the cause following the message.                                                                                         | •     | •         |          |             |           |                |         | • |
| nm          | Warning     | 13       | The combination of the network partition resources is invalid. (server name:%1)                                                 | NP resource combination error                         | Check the cluster configuration data.                                                                                          | •     | •         |          |             |           |                |         | • |
| nm          | Error       | 14       | The status of heartbeat %1 is abnormal.                                                                                         | Heartbeat abnormally                                  | Make sure there is no error in the network adapter and the network is correctly connected.                                     | •     | •         |          |             |           |                | •       | • |
| nm          | Information | 15       | The heartbeat %1 has been recovered to the normal status.                                                                       | Heartbeat recovered                                   | -                                                                                                                              | •     | •         |          |             |           |                |         |   |
| nm          | Error       | 16       | The network partition %2 of the server %1 has an error.                                                                         | Network partition abnormally                          | Refer to the event logs to check whether an error has occurred in a resource.                                                  | •     | •         |          |             |           |                | •       | • |

Messages reported by event log and alert

| Module Type | Event Type  | Event ID | Messages                                                                                                                              | Description                                           | Solution                                                                                                                       | Alert | Event log | User log | Mail report | SNMP Trap | Report setting |         |   |
|-------------|-------------|----------|---------------------------------------------------------------------------------------------------------------------------------------|-------------------------------------------------------|--------------------------------------------------------------------------------------------------------------------------------|-------|-----------|----------|-------------|-----------|----------------|---------|---|
|             |             |          |                                                                                                                                       |                                                       |                                                                                                                                |       |           |          |             |           | Alive          | Manager |   |
| nm          | Information | 17       | The network partition %2 of the server %1 has been recovered to the normal status.                                                    | Network partition recovered                           | -                                                                                                                              | •     | •         |          |             |           |                |         |   |
| nm          | Error       | 18       | Failed to start the resource %1. Server name:%2                                                                                       | Resource start failed                                 | Refer to the event logs to check whether an error has occurred in a resource.                                                  | •     | •         |          |             |           |                | •       | • |
| nm          | Information | 19       | Waiting for servers to start up has been canceled.                                                                                    | Waiting for servers to start up has been canceled.    | -                                                                                                                              | •     | •         |          |             |           |                |         |   |
| nm          | Error       | 20       | Network partition was detected. Shut down the server %1 for the cluster service to protect data.                                      | Network partition detected                            | No heartbeat resources can be used. Make sure there is no error in the network adapter and the network is correctly connected. | •     | •         |          |             |           |                |         |   |
| nm          | Error       | 21       | An error occurred when checking for a network partition. Shut down the server %1 for the cluster service to protect data.             | It was not possible to check for a network partition. | Refer to the event logs to check whether an error has occurred in a resource.                                                  | •     | •         |          |             |           |                |         |   |
| nm          | Error       | 22       | Network partition was detected. Execute action(%1) on the server %2 for the cluster service to protect data.                          | Network partition                                     | No heartbeat resources can be used. Make sure there is no error in the network adapter and the network is correctly connected. | •     | •         |          |             |           |                |         |   |
| nm          | Error       | 23       | An error occurred when checking for a network partition. Execute action(%1) on the server %2 for the cluster service to protect data. | Can not network partition resolution                  | Refer to the event logs to check whether an error has occurred in a resource.                                                  | •     | •         |          |             |           |                |         |   |
| nm          | Error       | 24       | Execute action(%1) on the server %2. (reason:%3)                                                                                      | Can not network partition resolution                  | No heartbeat resources can be used. Make sure there is no error in the network adapter and the network is correctly connected. | •     | •         |          |             |           |                |         |   |
| pm          | Information | 501      | Cluster service has been started properly.                                                                                            | Cluster service started                               | -                                                                                                                              | •     | •         | •        |             |           |                |         |   |
| pm          | Information | 502      | Cluster service is shutting down.                                                                                                     | Cluster service shutting down                         | -                                                                                                                              | •     | •         | •        |             |           |                |         |   |
| pm          | Error       | 510      | Cluster service has already been started.                                                                                             | Cluster service already started                       | Check the status of cluster service.                                                                                           | •     | •         | •        |             |           |                |         | • |
| pm          | Error       | 511      | Fatal error has occurred in the cluster service.                                                                                      | Critical error in cluster service                     | The service is not run by a user with required privilege or the system may not be able to operate properly.                    | •     | •         | •        | •           | •         |                |         | • |
| pm          | Error       | 512      | An error is detected in xml library.                                                                                                  | problem detected in xml library                       | The system may not be able to operate properly.                                                                                | •     | •         | •        |             |           |                |         | • |
| pm          | Error       | 513      | An error is detected in configuration file.                                                                                           | problem detected in configuration file                | Check the cluster configuration data.                                                                                          | •     | •         | •        | •           | •         |                |         | • |
| pm          | Error       | 514      | Configuration file does not exist.                                                                                                    | Configuration file not exists                         | Upload the cluster configuration data.                                                                                         | •     | •         | •        |             |           |                |         | • |
| pm          | Error       | 515      | My host name is not found in configuration file.                                                                                      | my name not found in configuration file               | Check the cluster configuration data.                                                                                          | •     | •         | •        |             |           |                |         | • |
| pm          | Error       | 520      | %1 process terminated abnormally.                                                                                                     | process exit abnormally                               | The system may not be able to operate properly.                                                                                | •     | •         | •        | •           | •         |                |         | • |

| Module Type | Event Type  | Event ID | Messages                                                                 | Description                                                         | Solution                                                                                                        | Alert | Event log | User log | Mail report | SNMP Trap | Report setting |         |   |
|-------------|-------------|----------|--------------------------------------------------------------------------|---------------------------------------------------------------------|-----------------------------------------------------------------------------------------------------------------|-------|-----------|----------|-------------|-----------|----------------|---------|---|
|             |             |          |                                                                          |                                                                     |                                                                                                                 |       |           |          |             |           | Alive          | Manager |   |
| pm          | Error       | 521      | The cluster service process returned an error. (halting system)          | Rc process exit with error                                          | Deactivation of group resources may be failed. Take appropriate action by following the group resource message. | •     | •         | •        |             |           |                |         | • |
| pm          | Error       | 522      | An error has occurred while initializing %1 process. (return code:%2)    | process init error                                                  | Check the cause of an initialization error and troubleshoot it.                                                 | •     | •         | •        | •           | •         |                |         | • |
| pm          | Information | 523      | The system will be shut down.                                            | system halting                                                      | -                                                                                                               | •     | •         | •        |             |           |                |         |   |
| pm          | Information | 524      | Cluster service will be stopped.                                         | Cluster service stopping                                            | -                                                                                                               | •     | •         | •        |             |           |                |         |   |
| pm          | Information | 525      | System will be rebooted.                                                 | System rebooting                                                    | -                                                                                                               | •     | •         | •        |             |           |                |         |   |
| pm          | Information | 526      | %1 process will be restarted.                                            | Process restarting                                                  | -                                                                                                               | •     | •         | •        |             |           |                |         |   |
| pm          | Information | 527      | Emergency shutdown is in progress.                                       | Emergency shutdown                                                  | -                                                                                                               | •     | •         | •        |             |           |                |         |   |
| pm          | Information | 528      | Generating STOP error.                                                   | Stop Error                                                          | -                                                                                                               | •     | •         | •        |             |           |                |         |   |
| pm          | Information | 529      | Generating hardware reset.                                               | HW reset                                                            | -                                                                                                               | •     | •         | •        |             |           |                |         |   |
| pm          | Information | 530      | There was a request to shut down the system from the %1.                 | request of system halt                                              | -                                                                                                               | •     | •         | •        |             |           |                |         |   |
| pm          | Information | 531      | There was a request to stop cluster service from the %1.                 | request of cluster service stop                                     | -                                                                                                               | •     | •         | •        |             |           |                |         |   |
| pm          | Information | 532      | There was a request to reboot system from the %1.                        | request of system reboot                                            | -                                                                                                               | •     | •         | •        |             |           |                |         |   |
| pm          | Information | 533      | There was a request to restart cluster service from the %1.              | request of cluster service restart                                  | -                                                                                                               | •     | •         | •        |             |           |                |         |   |
| pm          | Information | 534      | There was a request to resume cluster service from the %1.               | request of cluster service resume                                   | -                                                                                                               | •     | •         | •        |             |           |                |         |   |
| pm          | Information | 535      | There was a request to suspend cluster service from the %1.              | request of cluster service suspend                                  | -                                                                                                               | •     | •         | •        |             |           |                |         |   |
| pm          | Information | 536      | There was a request of emergency shutdown from the %1.                   | request of emergency shutdown                                       | -                                                                                                               | •     | •         | •        |             |           |                |         |   |
| pm          | Information | 537      | There was a request to generate STOP error from the %1.                  | request of STOP error                                               | -                                                                                                               | •     | •         | •        |             |           |                |         |   |
| pm          | Information | 538      | There was a request to generate hardware reset from the %1.              | request of HW reset                                                 | -                                                                                                               | •     | •         | •        |             |           |                |         |   |
| pm          | Information | 540      | Requesting shutdown to the automatic running control software.           | shutdown request to the automatic running control software start    | -                                                                                                               | •     | •         | •        |             |           |                |         |   |
| pm          | Information | 541      | Requesting shutdown (reboot) to the automatic running control software.  | shutdown (reboot) request to the automatic running control software | -                                                                                                               | •     | •         | •        |             |           |                |         |   |
| pm          | Information | 542      | Shutdown request to the automatic running control software is completed. | shutdown request to the automatic running control software complete | -                                                                                                               | •     | •         | •        |             |           |                |         |   |



Messages reported by event log and alert

| Module Type | Event Type  | Event ID | Messages                                                                              | Description                                    | Solution                                                                                                                                                                         | Alert | Event log | User log | Mail report | SNMP Trap | Report setting |         |   |
|-------------|-------------|----------|---------------------------------------------------------------------------------------|------------------------------------------------|----------------------------------------------------------------------------------------------------------------------------------------------------------------------------------|-------|-----------|----------|-------------|-----------|----------------|---------|---|
|             |             |          |                                                                                       |                                                |                                                                                                                                                                                  |       |           |          |             |           | Alive          | Manager |   |
| pm          | Error       | 543      | The automatic running control software returned an error to the shutdown request.     | shutdown by ESMPRO/AC fail                     | The automatic operating settings may be incorrect. Check the settings.                                                                                                           | •     | •         | •        |             |           |                |         | • |
| pm          | Error       | 544      | Communications with the automatic running control software failed.                    | Communications with ESMPRO/AC fail             | The system may not be able to operate properly.                                                                                                                                  | •     | •         | •        |             |           |                |         | • |
| rc          | Information | 1010     | The group %1 is starting.                                                             | group-start started                            | -                                                                                                                                                                                | •     | •         | •        |             |           |                |         |   |
| rc          | Information | 1011     | The group %1 has been started.                                                        | group-start ended                              | -                                                                                                                                                                                | •     | •         | •        |             |           |                |         |   |
| rc          | Error       | 1012     | Failed to start the group %1.                                                         | group-start failed                             | Take appropriate action by following the group resource message.                                                                                                                 | •     | •         | •        |             |           |                |         | • |
| rc          | Information | 1015     | Waiting for group %1 to start has started.                                            | waiting for group to start has started.        | -                                                                                                                                                                                | •     | •         | •        |             |           |                |         |   |
| rc          | Information | 1016     | Waiting for group %1 to start has been completed.                                     | waiting for group to start has been completed. | -                                                                                                                                                                                | •     | •         | •        |             |           |                |         |   |
| rc          | Error       | 1017     | Group start was canceled because waiting for group %1 to start was timed out. (%2)    | waiting for group to start has timed out.      | Check the status of the group waiting to start. If the group has not yet been started, re-perform the group operation after starting that group.                                 | •     | •         | •        |             |           |                |         |   |
| rc          | Warning     | 1018     | Waiting for group %1 to start has timed out. However, group start continues. (%2)     | group start continues.                         | -                                                                                                                                                                                | •     | •         | •        |             |           |                |         |   |
| rc          | Warning     | 1019     | Server %1 is not in a condition to start group %2.                                    | cannot-start-group                             | Perform server recovery if the target server is suspended (Isolated). If it is suspended (Network Partition Unsolved), recover network partition resources to the normal status. | •     |           |          |             |           |                |         |   |
| rc          | Information | 1020     | The group %1 is stopping.                                                             | group-stop started                             | -                                                                                                                                                                                | •     | •         | •        |             |           |                |         |   |
| rc          | Information | 1021     | The group %1 has been stopped.                                                        | group-stop ended                               | -                                                                                                                                                                                | •     | •         | •        |             |           |                |         |   |
| rc          | Error       | 1022     | Failed to stop the group %1.                                                          | group-stop failed                              | Take appropriate action by following the group resource message.                                                                                                                 | •     | •         | •        |             |           |                |         | • |
| rc          | Information | 1025     | Waiting for group %1 to stop has started.                                             | waiting for group to stop has started.         | -                                                                                                                                                                                | •     | •         | •        |             |           |                |         |   |
| rc          | Information | 1026     | Waiting for group %1 to stop has started.                                             | waiting for group to stop has been completed.  | -                                                                                                                                                                                | •     | •         | •        |             |           |                |         |   |
| rc          | Error       | 1027     | Group stop has been canceled because waiting for group %1 to stop has timed out. (%2) | waiting for group to stop has timed out.       | Check the status of the group waiting to stop. If the group has not yet been stopped, re-perform the group operation after stopping that group.                                  | •     | •         | •        |             |           |                |         |   |
| rc          | Warning     | 1028     | Waiting for group %1 to stop has timed out. However, group stop continues. (%2)       | group stop continues.                          | -                                                                                                                                                                                | •     | •         | •        |             |           |                |         |   |
| rc          | Information | 1030     | The resource %1 is starting.                                                          | resource-start started                         | -                                                                                                                                                                                |       | •         | •        |             |           |                |         |   |

| Module Type | Event Type  | Event ID | Messages                                                                                 | Description                                             | Solution                                                                                                                                                                         | Alert | Event log | User log | Mail report | SNMP Trap | Report setting |         |
|-------------|-------------|----------|------------------------------------------------------------------------------------------|---------------------------------------------------------|----------------------------------------------------------------------------------------------------------------------------------------------------------------------------------|-------|-----------|----------|-------------|-----------|----------------|---------|
|             |             |          |                                                                                          |                                                         |                                                                                                                                                                                  |       |           |          |             |           | Alive          | Manager |
| rc          | Information | 1031     | The resource %1 has been started.                                                        | resource-start ended                                    | -                                                                                                                                                                                |       | •         | •        |             |           |                |         |
| rc          | Error       | 1032     | Failed to start the resource %1. (%2 : %3)                                               | resource-start failed                                   | Check the cause for failing to start the resource. If a stall occurs during start processing, "Failed to start the resource %1. (99 : command is timeout)" is output.            | •     | •         | •        | •           | •         |                | •       |
| rc          | Error       | 1033     | Failed to start the recovery script of resource %1. (%2 : %3)                            | recoverscript-start failed                              | Check the cause for failing to start the recovery script.                                                                                                                        | •     | •         | •        |             |           |                | •       |
| rc          | Information | 1040     | The resource %1 is stopping.                                                             | resource-stop started                                   | -                                                                                                                                                                                |       | •         | •        |             |           |                |         |
| rc          | Information | 1041     | The resource %1 has been stopped.                                                        | resource-stop ended                                     | -                                                                                                                                                                                |       | •         | •        |             |           |                |         |
| rc          | Error       | 1042     | Failed to stop the resource %1. (%2 : %3)                                                | resource-stop failed                                    | Check the cause for failing to stop the resource. If a stall occurs during stop processing, "Failed to stop the resource %1. (99 : command is timeout)" is output.               | •     | •         | •        | •           | •         |                | •       |
| rc          | Information | 1050     | Moving the group %1.                                                                     | group-move started                                      | -                                                                                                                                                                                | •     | •         | •        |             |           |                |         |
| rc          | Information | 1051     | The group %1 has been moved.                                                             | group-move ended                                        | -                                                                                                                                                                                | •     | •         | •        |             |           |                |         |
| rc          | Error       | 1052     | Failed to move the group %1.                                                             | group-move failed                                       | Take appropriate action by following the group resource message.                                                                                                                 | •     | •         | •        |             |           |                | •       |
| rc          | Warning     | 1059     | Server %1 is not in a condition to move group %2.                                        | cannot-move-group                                       | Perform server recovery if the target server is suspended (Isolated). If it is suspended (Network Partition Unsolved), recover network partition resources to the normal status. | •     |           |          |             |           |                |         |
| rc          | Information | 1060     | Failing over the group %1.                                                               | group-failover started                                  | -                                                                                                                                                                                | •     | •         | •        |             |           |                |         |
| rc          | Information | 1061     | The group %1 has been failed over.                                                       | group-failover ended                                    | -                                                                                                                                                                                | •     | •         | •        |             |           |                |         |
| rc          | Error       | 1062     | Failed to fail over the group %1.                                                        | group-failover failed                                   | Take appropriate action by following the group resource message.                                                                                                                 | •     | •         | •        |             |           |                | •       |
| rc          | Information | 1070     | Restarting the group %1.                                                                 | group-restart started                                   | -                                                                                                                                                                                | •     | •         | •        |             |           |                |         |
| rc          | Information | 1071     | The group %1 has been restarted.                                                         | group-restart ended                                     | -                                                                                                                                                                                | •     | •         | •        |             |           |                |         |
| rc          | Error       | 1072     | Failed to restart the group %1.                                                          | group-restart failed                                    | Take appropriate action by following the group resource message.                                                                                                                 | •     | •         | •        |             |           |                | •       |
| rc          | Error       | 1077     | Group failover has failed because there is a server incapable of internal communication. | group-failover failed (internal communication disabled) | Check the LAN heartbeat status in kernel mode. Start the group after recovering internal communication.                                                                          | •     | •         | •        |             |           |                |         |
| rc          | Information | 1080     | Restarting the resource %1.                                                              | resource-restart started                                | -                                                                                                                                                                                | •     | •         | •        |             |           |                |         |
| rc          | Information | 1081     | The resource %1 has been restarted.                                                      | resource-restart ended                                  | -                                                                                                                                                                                | •     | •         | •        |             |           |                |         |

Messages reported by event log and alert

| Module Type | Event Type  | Event ID | Messages                                                                                                                             | Description                                                        | Solution                                                                                                                                   | Alert | Event log | User log | Mail report | SNMP Trap | Report setting |         |   |
|-------------|-------------|----------|--------------------------------------------------------------------------------------------------------------------------------------|--------------------------------------------------------------------|--------------------------------------------------------------------------------------------------------------------------------------------|-------|-----------|----------|-------------|-----------|----------------|---------|---|
|             |             |          |                                                                                                                                      |                                                                    |                                                                                                                                            |       |           |          |             |           | Alive          | Manager |   |
| rc          | Error       | 1082     | Failed to restart the resource %1.                                                                                                   | resource-restart failed                                            | Take appropriate action by following the group resource message.                                                                           | •     | •         | •        |             |           |                |         | • |
| rc          | Information | 1090     | Shutting down the cluster.                                                                                                           | cluster shutdown                                                   | -                                                                                                                                          | •     | •         | •        |             |           |                |         |   |
| rc          | Information | 1091     | Shutting down the server.                                                                                                            | server shutdown                                                    | -                                                                                                                                          | •     | •         | •        |             |           |                |         |   |
| rc          | Error       | 1092     | Group %1 is started on more than one server.                                                                                         | group double start                                                 | Server will automatically be shut down. Check the cause for the group to be started in more than one server.                               | •     | •         | •        | •           | •         |                |         | • |
| rc          | Error       | 1093     | The system shutdown was performed by other than the cluster service.                                                                 | system shutdown by other than cluster service                      | It is considered as an error if the system shuts down by other than cluster service. Follow the appropriate steps to shut down the system. | •     | •         | •        |             |           |                |         | • |
| rc          | Warning     | 1100     | Shutdown count is reached the maximum number (%1). Final action of resource %2 was ignored.                                          | shutdown count reached the limit                                   | -                                                                                                                                          | •     | •         | •        | •           | •         |                |         | • |
| rc          | Warning     | 1101     | Since there is no other normally running server, the final action for an activation error of group resource %1 was suppressed.       | Suppression of final action for activation error                   | -                                                                                                                                          | •     | •         | •        |             |           |                |         |   |
| rc          | Warning     | 1102     | Since there is no other normally running server, the final action for a deactivation error of group resource %1 was suppressed.      | Suppression of final action for deactivation error                 | -                                                                                                                                          | •     | •         | •        |             |           |                |         |   |
| rc          | Warning     | 1103     | Since server %1 is specified as that which suppresses shutdown at both-system activation detection, it ignored the shutdown request. | Suppression of shutdown caused by both-system activation detection | -                                                                                                                                          | •     | •         | •        |             |           |                |         |   |
| rc          | Warning     | 1104     | A mismatch in the group %1 status occurs between the servers.                                                                        | Generation of group status mismatch                                | Restart the group, move it, or reboot the cluster.                                                                                         | •     | •         | •        |             |           |                |         |   |
| rc          | Information | 1110     | Server %1 is returned to the cluster.                                                                                                | server returned                                                    | -                                                                                                                                          | •     | •         | •        |             |           |                |         |   |
| rc          | Information | 1111     | Server %1 is isolated from the cluster.                                                                                              | server isolated                                                    | -                                                                                                                                          | •     | •         | •        |             |           |                |         |   |
| rc          | Information | 1112     | Server %1 started to return to the cluster.                                                                                          | server return start                                                | -                                                                                                                                          | •     | •         | •        |             |           |                |         |   |
| rc          | Error       | 1113     | Server %1 failed to return to the cluster.                                                                                           | server return fail                                                 | The system may not be able to operate properly.                                                                                            | •     | •         | •        |             |           |                |         | • |
| rc          | Information | 1120     | Server %1 will notify the automatic running control software of shutdown start.                                                      | shutdown notification start                                        | -                                                                                                                                          | •     | •         | •        |             |           |                |         |   |

| Module Type | Event Type  | Event ID | Messages                                                                                                                                           | Description                                                       | Solution                                                                                                                                                                         | Alert | Event log | User log | Mail report | SNMP Trap | Report setting | Manager |
|-------------|-------------|----------|----------------------------------------------------------------------------------------------------------------------------------------------------|-------------------------------------------------------------------|----------------------------------------------------------------------------------------------------------------------------------------------------------------------------------|-------|-----------|----------|-------------|-----------|----------------|---------|
|             |             |          |                                                                                                                                                    |                                                                   |                                                                                                                                                                                  |       |           |          |             |           | Alive          | Alive   |
| rc          | Error       | 1121     | The automatic running control software returned an error to the shutdown start notification in server %1.                                          | shutdown notification fail                                        | The automatic operating settings may be incorrect. Check the settings.                                                                                                           | •     | •         | •        |             |           |                | •       |
| rc          | Information | 1122     | Server %1 notified the automatic running control software of shutdown start.                                                                       | shutdown notification finish                                      | -                                                                                                                                                                                | •     | •         | •        |             |           |                |         |
| rc          | Information | 1123     | The automatic running control software is checking the power status of shared disks. A server will be restarted after the power status is checked. | waiting for disk power-on                                         | -                                                                                                                                                                                | •     | •         | •        |             |           |                |         |
| rc          | Error       | 1124     | An error was returned from the automatic running control software. Failed to check the power status of shared disks.                               | disk power-on confirmation failed                                 | The automatic operating settings may be incorrect. Check the settings. An error may have occurred in the automatic power control unit. Check the automatic power control unit.   | •     | •         | •        |             |           |                | •       |
| rc          | Error       | 1125     | Server %1 failed to communicate with the automatic running control software.                                                                       | communications with the automatic running control software failed | The system may not be able to operate properly.                                                                                                                                  | •     | •         | •        |             |           |                | •       |
| rc          | Information | 1130     | Starting a single resource %1.                                                                                                                     | single-resource-start started                                     | -                                                                                                                                                                                | •     | •         | •        |             |           |                |         |
| rc          | Information | 1131     | A single resource %1 has been started.                                                                                                             | single-resource-start ended                                       | -                                                                                                                                                                                | •     | •         | •        |             |           |                |         |
| rc          | Error       | 1132     | Failed to start a single resource %1.                                                                                                              | single-resource-start failed                                      | Take appropriate action by following the group resource message.                                                                                                                 | •     | •         | •        |             |           |                | •       |
| rc          | Warning     | 1139     | Server %1 is not in a condition to start a single resource %2.                                                                                     | cannot-start-single-resource                                      | Perform server recovery if the target server is suspended (Isolated). If it is suspended (Network Partition Unsolved), recover network partition resources to the normal status. | •     |           |          |             |           |                |         |
| rc          | Information | 1140     | Stopping a single resource %1.                                                                                                                     | single-resource-stop started                                      | -                                                                                                                                                                                | •     | •         | •        |             |           |                |         |
| rc          | Information | 1141     | A single resource %1 has been stopped.                                                                                                             | single-resource-stop ended                                        | -                                                                                                                                                                                | •     | •         | •        |             |           |                |         |
| rc          | Error       | 1142     | Failed to stop a single resource %1.                                                                                                               | single-resource-stop failed                                       | Take appropriate action by following the group resource message.                                                                                                                 | •     | •         | •        |             |           |                | •       |
| rc          | Information | 1150     | The group %1 is being migrated.                                                                                                                    | The group is being migrated.                                      | -                                                                                                                                                                                | •     | •         | •        |             |           |                |         |
| rc          | Information | 1151     | The group %1 has been migrated.                                                                                                                    | The group has been migrated.                                      | -                                                                                                                                                                                | •     | •         | •        |             |           |                |         |
| rc          | Error       | 1152     | Failed to migrate the group %1.                                                                                                                    | Migrating the group has failed.                                   | Take appropriate action by following the group resource message.                                                                                                                 | •     | •         | •        |             |           |                |         |

Messages reported by event log and alert

| Module Type | Event Type  | Event ID | Messages                                                                                                | Description                                        | Solution                                                                                                                                                                                     | Alert | Event log | User log | Mail report | SNMP Trap | Report setting |         |  |
|-------------|-------------|----------|---------------------------------------------------------------------------------------------------------|----------------------------------------------------|----------------------------------------------------------------------------------------------------------------------------------------------------------------------------------------------|-------|-----------|----------|-------------|-----------|----------------|---------|--|
|             |             |          |                                                                                                         |                                                    |                                                                                                                                                                                              |       |           |          |             |           | Alive          | Manager |  |
| rc          | Warning     | 1159     | Server %1 is not in a condition to migrate group %2.                                                    | The group cannot be migrated.                      | Perform server recovery if the target server is suspended (isolated). If it is suspended (due to an unresolved network partition), recover network partition resources to the normal status. | •     | •         | •        |             |           |                |         |  |
| rc          | Information | 1170     | Server %1 in the same server group (%2) has been set as the destination for the group %3.               | The destination found in the same server group     | -                                                                                                                                                                                            | •     | •         | •        |             |           |                |         |  |
| rc          | Information | 1171     | Server %1 not in the same server group (%2) has been set as the destination for the group %3.           | The destination found in the other server group    | -                                                                                                                                                                                            | •     | •         | •        |             |           |                |         |  |
| rc          | Warning     | 1179     | Can not fail over the group %1 because there is no appropriate destination in the same server group %2. | The destination not found in the same server group | Check if other servers in the same server group are stopped or isolated. If so, start the servers or return the servers to the cluster.                                                      | •     | •         | •        |             |           |                |         |  |
| rc          | Information | 1200     | The resource %1 will be restarted since starting the resource %2 failed.                                | resource-restart by resource-acterr                | -                                                                                                                                                                                            | •     | •         | •        |             |           |                |         |  |
| rc          | Information | 1201     | The group %1 will be failed over to server %2 since starting the resource %3 failed.                    | group-failover by resource-acterr                  | -                                                                                                                                                                                            | •     | •         | •        |             |           |                |         |  |
| rc          | Information | 1202     | The group %1 will be stopped since starting the resource %2 failed.                                     | group-stop by resource-acterr                      | -                                                                                                                                                                                            | •     | •         | •        |             |           |                |         |  |
| rc          | Information | 1203     | The cluster service will be stopped since starting the resource %1 failed.                              | service-stop by resource-acterr                    | -                                                                                                                                                                                            | •     | •         | •        |             |           |                |         |  |
| rc          | Information | 1204     | The system will be shut down since starting the resource %1 failed.                                     | shutdown-system by resource-acterr                 | -                                                                                                                                                                                            | •     | •         | •        |             |           |                |         |  |
| rc          | Information | 1205     | The system will be rebooted since starting the resource %1 failed.                                      | reboot-system by resource-acterr                   | -                                                                                                                                                                                            | •     | •         | •        |             |           |                |         |  |
| rc          | Information | 1220     | The resource %1 will be stopped again since stopping the resource %2 failed.                            | resource-stop retry by resource-deacterr           | -                                                                                                                                                                                            | •     | •         | •        |             |           |                |         |  |
| rc          | Information | 1223     | The cluster service will be stopped since stopping the resource %1 failed.                              | service-stop by resource-deacterr                  | -                                                                                                                                                                                            | •     | •         | •        |             |           |                |         |  |
| rc          | Information | 1224     | The system will be shut down since stopping the resource %1 failed.                                     | shutdown-system by resource-deacterr               | -                                                                                                                                                                                            | •     | •         | •        |             |           |                |         |  |
| rc          | Information | 1225     | The system will be rebooted since stopping the resource %1 failed.                                      | reboot-system by resource-deacterr                 | -                                                                                                                                                                                            | •     | •         | •        |             |           |                |         |  |
| rc          | Information | 1241     | Hardware reset will be generated since starting the resource %1 failed.                                 | hw-reset by resource-acterr                        | -                                                                                                                                                                                            | •     | •         | •        |             |           |                |         |  |

| Module Type | Event Type  | Event ID | Messages                                                                       | Description                                                              | Solution                                                 | Alert | Event log | User log | Mail report | SNMP Trap | Report setting |         |   |
|-------------|-------------|----------|--------------------------------------------------------------------------------|--------------------------------------------------------------------------|----------------------------------------------------------|-------|-----------|----------|-------------|-----------|----------------|---------|---|
|             |             |          |                                                                                |                                                                          |                                                          |       |           |          |             |           | Alive          | Manager |   |
| rc          | Information | 1242     | STOP error will be generated since starting the resource %1 failed.            | stop-error by resource-acterr                                            | -                                                        | •     | •         | •        |             |           |                |         |   |
| rc          | Information | 1281     | Hardware reset will be generated since stopping the resource %1 failed.        | hw-reset by resource-deacterr                                            | -                                                        | •     | •         | •        |             |           |                |         |   |
| rc          | Information | 1282     | STOP error will be generated since stopping the resource %1 failed.            | stop-error by resource-deacterr                                          | -                                                        | •     | •         | •        |             |           |                |         |   |
| rc          | Information | 1300     | Script before final action upon activation failure in resource %1 started.     | Script before final action upon resource activation failure started.     | -                                                        | •     | •         | •        |             |           |                |         |   |
| rc          | Information | 1301     | Script before final action upon activation failure in resource %1 completed.   | Script before final action upon resource activation failure completed.   | -                                                        | •     | •         | •        |             |           |                |         |   |
| rc          | Information | 1302     | Script before final action upon deactivation failure in resource %1 started.   | Script before final action upon resource deactivation failure started.   | -                                                        | •     | •         | •        |             |           |                |         |   |
| rc          | Information | 1303     | Script before final action upon deactivation failure in resource %1 completed. | Script before final action upon resource deactivation failure completed. | -                                                        | •     | •         | •        |             |           |                |         |   |
| rc          | Information | 1304     | Script before activation in resource %1 started.                               | Script before resource activation started.                               | -                                                        | •     | •         | •        |             |           |                |         |   |
| rc          | Information | 1305     | Script before activation in resource %1 completed.                             | Script before resource activation completed.                             | -                                                        | •     | •         | •        |             |           |                |         |   |
| rc          | Information | 1306     | Script after activation in resource %1 started.                                | Script after resource activation started.                                | -                                                        | •     | •         | •        |             |           |                |         |   |
| rc          | Information | 1307     | Script after activation in resource %1 completed.                              | Script after resource activation completed.                              | -                                                        | •     | •         | •        |             |           |                |         |   |
| rc          | Information | 1308     | Script before deactivation in resource %1 started.                             | Script before resource deactivation started.                             | -                                                        | •     | •         | •        |             |           |                |         |   |
| rc          | Information | 1309     | Script before deactivation in resource %1 completed.                           | Script before resource deactivation completed.                           | -                                                        | •     | •         | •        |             |           |                |         |   |
| rc          | Information | 1310     | Script after deactivation in resource %1 started.                              | Script after resource deactivation started.                              | -                                                        | •     | •         | •        |             |           |                |         |   |
| rc          | Information | 1311     | Script after deactivation in resource %1 completed.                            | Script after resource deactivation completed.                            | -                                                        | •     | •         | •        |             |           |                |         |   |
| rc          | Error       | 1340     | Script before final action upon activation failure in resource %1 failed.      | Check the cause of the script failure and take measures.                 | Check the cause of the script failure and take measures. | •     | •         | •        |             |           |                |         | • |
| rc          | Error       | 1341     | Script before final action upon deactivation failure in resource %1 failed.    | Check the cause of the script failure and take measures.                 | Check the cause of the script failure and take measures. | •     | •         | •        |             |           |                |         | • |
| rc          | Error       | 1342     | Failed to execute script before activation in resource %1.                     | Check the cause of the script failure and take measures.                 | Check the cause of the script failure and take measures. | •     | •         | •        |             |           |                |         | • |
| rc          | Error       | 1343     | Failed to execute script after activation in resource %1.                      | Script after resource activation has failed.                             | Check the cause of the script failure and take measures. | •     | •         | •        |             |           |                |         | • |

Messages reported by event log and alert

| Module Type | Event Type  | Event ID | Messages                                                                 | Description                                                              | Solution                                                 | Alert | Event log | User log | Mail report | SNMP Trap | Report setting |         |   |
|-------------|-------------|----------|--------------------------------------------------------------------------|--------------------------------------------------------------------------|----------------------------------------------------------|-------|-----------|----------|-------------|-----------|----------------|---------|---|
|             |             |          |                                                                          |                                                                          |                                                          |       |           |          |             |           | Alive          | Manager |   |
| rc          | Error       | 1344     | Failed to execute script before deactivation in resource %1.             | Check the cause of the script failure and take measures.                 | Check the cause of the script failure and take measures. | •     | •         | •        |             |           |                |         | • |
| rc          | Error       | 1345     | Failed to execute script after deactivation in resource %1.              | Check the cause of the script failure and take measures.                 | Check the cause of the script failure and take measures. | •     | •         | •        |             |           |                |         | • |
| rc          | Information | 1400     | Forced stop (BMC Power Off) of server %1 has been requested.             | forced-stop (bmc-poweroff) requested                                     | -                                                        |       |           | •        |             |           |                |         |   |
| rc          | Information | 1401     | Forced stop (BMC Power Cycle) of server %1 has been requested.           | forced-stop (bmc-powercycle) requested                                   | -                                                        |       |           | •        |             |           |                |         |   |
| rc          | Information | 1402     | Forced stop (BMC Reset) of server %1 has been requested.                 | forced-stop (bmc-reset) requested                                        | -                                                        |       |           | •        |             |           |                |         |   |
| rc          | Information | 1403     | Forced stop (BMC NMI) of server %1 has been requested.                   | forced-stop (bmc-nmi) requested                                          | -                                                        |       |           | •        |             |           |                |         |   |
| rc          | Information | 1404     | Forced stop has been requested.                                          | forced-stop (VMware vSphere CLI) requested                               | -                                                        |       |           | •        |             |           |                |         |   |
| rc          | Information | 1405     | Script for forced stop has started.                                      | Script for forced-stop has started.                                      | -                                                        |       |           | •        |             |           |                |         |   |
| rc          | Information | 1406     | Script for forced stop has completed.                                    | Script for forced-stop has completed.                                    | -                                                        |       |           | •        |             |           |                |         |   |
| rc          | Error       | 1420     | Forced stop (BMC Power Off) of server %1 failed.                         | forced-stop (bmc-poweroff) failed                                        | The system may not be able to operate properly.          | •     | •         | •        |             |           |                |         | • |
| rc          | Error       | 1421     | Forced stop (BMC Power Cycle) of server %1 failed.                       | forced-stop (bmc-powercycle) failed                                      | The system may not be able to operate properly.          | •     | •         | •        |             |           |                |         | • |
| rc          | Error       | 1422     | Forced stop (BMC Reset) of server %1 failed.                             | forced-stop (bmc-reset) failed                                           | The system may not be able to operate properly.          | •     | •         | •        |             |           |                |         | • |
| rc          | Error       | 1423     | Forced stop (BMC NMI) of server %1 failed.                               | forced-stop (bmc-nmi) failed                                             | The system may not be able to operate properly.          | •     | •         | •        |             |           |                |         | • |
| rc          | Error       | 1424     | Forced stop failed.                                                      | forced-stop (VMware vSphere CLI) failed                                  | The system may not be able to operate properly.          | •     | •         | •        |             |           |                |         | • |
| rc          | Error       | 1425     | Script for forced stop has failed. (%1)                                  | Script for forced-stop has stopped.                                      | Check the cause of the script failure and take measures. | •     | •         | •        |             |           |                |         | • |
| rc          | Error       | 1426     | Script for forced stop has timed out.                                    | Timeout on the-script for forced stop                                    | Check the cause of the script timeout and take measures. | •     | •         | •        |             |           |                |         | • |
| rc          | Information | 1440     | The CPU frequency has been set to high.                                  | The CPU frequency has been set to high.                                  | -                                                        | •     | •         | •        |             |           |                |         |   |
| rc          | Information | 1441     | The CPU frequency has been set to low.                                   | The CPU frequency has been set to low.                                   | -                                                        | •     | •         | •        |             |           |                |         |   |
| rc          | Information | 1442     | The CPU frequency has been set to %1.                                    | The CPU frequency has been set.                                          | -                                                        | •     | •         | •        |             |           |                |         |   |
| rc          | Information | 1443     | CPU frequency setting has been switched to automatic control by cluster. | CPU frequency setting has been switched to automatic control by cluster. | -                                                        | •     | •         | •        |             |           |                |         |   |
| rc          | Error       | 1460     | CPU frequency control cannot be used.                                    | CPU frequency control cannot be used.                                    | Check BIOS settings and kernel settings.                 | •     | •         | •        |             |           |                |         | • |

| Module Type | Event Type  | Event ID | Messages                                                                             | Description                                                                     | Solution                                                                                                                                                   | Alert | Event log | User log | Mail report | SNMP Trap | Report setting |         |
|-------------|-------------|----------|--------------------------------------------------------------------------------------|---------------------------------------------------------------------------------|------------------------------------------------------------------------------------------------------------------------------------------------------------|-------|-----------|----------|-------------|-----------|----------------|---------|
|             |             |          |                                                                                      |                                                                                 |                                                                                                                                                            |       |           |          |             |           | Alive          | Manager |
| rc          | Error       | 1461     | Failed to set the CPU frequency to high.                                             | Setting the CPU frequency to high has failed.                                   | Check BIOS settings and kernel settings. Check if the cluster service is started. Check if the configuration is set so that CPU frequency control is used. | •     | •         | •        |             |           |                | •       |
| rc          | Error       | 1462     | Failed to set the CPU frequency to low.                                              | Setting the CPU frequency to low has failed.                                    | Check BIOS settings and kernel settings. Check if the cluster service is started. Check if the configuration is set so that CPU frequency control is used. | •     | •         | •        |             |           |                | •       |
| rc          | Error       | 1463     | Failed to set the CPU frequency to %1.                                               | Setting the CPU frequency has failed.                                           | Check BIOS settings and kernel settings. Check if the cluster service is started. Check if the configuration is set so that CPU frequency control is used. | •     | •         | •        |             |           |                | •       |
| rc          | Error       | 1464     | Failed to switch the CPU frequency setting to automatic control by cluster.          | Switching the CPU frequency setting to automatic control by cluster has failed. | Check if the cluster service is started. Check if the configuration is set so that CPU frequency control is used.                                          | •     | •         | •        |             |           |                | •       |
| rc          | Information | 1470     | Server %1 has been set as the destination for the group %2 (reason: %3).             | destination found                                                               | -                                                                                                                                                          | •     | •         | •        |             |           |                |         |
| rc          | Warning     | 1471     | There is no appropriate destination for the group %1 (reason: %2).                   | destination not found                                                           | Check if any monitor resources detects an error on the other servers.                                                                                      | •     | •         | •        |             |           |                | •       |
| rc          | Warning     | 1472     | Server %1 is not in a condition to start group %2 (reason: %3).                      | not in a condition to start group                                               | Check if any monitor resources detects an error on the server.                                                                                             | •     | •         | •        |             |           |                |         |
| rc          | Error       | 1480     | Group start has been canceled because waiting for group %1 to start has failed. (%2) | waiting for group to start failed                                               | -                                                                                                                                                          | •     | •         | •        |             |           |                |         |
| rc          | Warning     | 1481     | Waiting for group %1 to start has failed. However, group start continues. (%2)       | waiting for group to start failed                                               | -                                                                                                                                                          | •     | •         | •        |             |           |                |         |
| rc          | Error       | 1482     | Group start has been canceled because waiting for group %1 to start has canceled.    | waiting for group to start canceled                                             | -                                                                                                                                                          | •     | •         | •        |             |           |                |         |
| rc          | Warning     | 1483     | Waiting for group %1 to start has canceled. However, group start continues.          | waiting for group to start canceled                                             | -                                                                                                                                                          | •     | •         | •        |             |           |                |         |
| rc          | Error       | 1484     | Group stop has been canceled because waiting for group %1 to stop has failed. (%2)   | waiting for group to stop failed                                                | -                                                                                                                                                          | •     | •         | •        |             |           |                |         |
| rc          | Warning     | 1485     | Waiting for group %1 to stop has failed. However, group stop continues. (%2)         | waiting for group to stop failed                                                | -                                                                                                                                                          | •     | •         | •        |             |           |                |         |
| rc          | Error       | 1486     | Group stop has been canceled because waiting for group %1 to stop has canceled.      | waiting for group to stop canceled                                              | -                                                                                                                                                          | •     | •         | •        |             |           |                |         |



Messages reported by event log and alert

| Module Type | Event Type  | Event ID | Messages                                                                              | Description                        | Solution                                        | Alert | Event log | User log | Mail report | SNMP Trap | Report setting |         |   |
|-------------|-------------|----------|---------------------------------------------------------------------------------------|------------------------------------|-------------------------------------------------|-------|-----------|----------|-------------|-----------|----------------|---------|---|
|             |             |          |                                                                                       |                                    |                                                 |       |           |          |             |           | Alive          | Manager |   |
| rc          | Warning     | 1487     | Waiting for group %1 to stop has canceled. However, group stop continues.             | waiting for group to stop canceled | -                                               | •     | •         | •        |             |           |                |         |   |
| rm          | Information | 1501     | Monitor %1 has been started.                                                          | Monitor start                      | -                                               | •     | •         | •        |             |           |                |         |   |
| rm          | Information | 1502     | Monitor %1 has been stopped.                                                          | Monitor stop                       | -                                               | •     | •         | •        |             |           |                |         |   |
| rm          | Information | 1503     | Monitor %1 does not monitor in this server.                                           | Not target server                  | -                                               | •     | •         | •        |             |           |                |         |   |
| rm          | Warning     | 1504     | Monitor %1 is in the warning status. (%2 : %3)                                        | Monitor warn                       | Check the cause of Warning.                     | •     | •         | •        |             |           |                |         | • |
| rm          | Warning     | 1505     | The number of monitor resources reached the maximum number. (registered resource: %1) | invalid number of monitor resource | Check the cluster configuration data.           | •     | •         | •        |             |           |                |         | • |
| rm          | Warning     | 1506     | Configuration of %1 is invalid. (%2 : %3)                                             | invalid monitor resource           | Check the cluster configuration data.           | •     | •         | •        |             |           |                |         | • |
| rm          | Error       | 1507     | Failed to start monitor %1.                                                           | monitor starting failed            | The system may not be able to operate properly. | •     | •         | •        | •           | •         |                |         | • |
| rm          | Error       | 1508     | Failed to stop monitor %1.                                                            | monitor stopping failed            | The system may not be able to operate properly. | •     | •         | •        |             |           |                |         | • |
| rm          | Error       | 1509     | Monitor %1 detected an error. (%2 : %3)                                               | monitor failed                     | Check the cause for monitor error.              | •     | •         | •        | •           | •         |                |         | • |
| rm          | Information | 1510     | Monitor %1 is not monitored.                                                          | not monitored                      | -                                               | •     | •         | •        |             |           |                |         |   |
| rm          | Information | 1511     | Monitor resource has not been registered.                                             | unregistered monitor resource      | -                                               | •     | •         | •        |             |           |                |         |   |
| rm          | Information | 1512     | %1 was stopped for failure in monitor %2.                                             | relation stop                      | -                                               | •     | •         | •        |             |           |                |         |   |
| rm          | Information | 1513     | %1 was restarted for failure in monitor %2.                                           | relation restart                   | -                                               | •     | •         | •        |             |           |                |         |   |
| rm          | Information | 1514     | %1 was failed over for failure in monitor %2.                                         | relation group failover            | -                                               | •     | •         | •        |             |           |                |         |   |
| rm          | Information | 1515     | There was a request to stop cluster for failure in monitor %1.                        | cluster stop                       | -                                               | •     | •         | •        |             |           |                |         |   |
| rm          | Information | 1516     | There was a request to shut down the system for failure in monitor %1.                | system shutdown                    | -                                               | •     | •         | •        |             |           |                |         |   |
| rm          | Information | 1517     | There was a request to restart the system for failure in monitor %1.                  | system reboot                      | -                                               | •     | •         | •        |             |           |                |         |   |
| rm          | Error       | 1518     | Failed to stop %1 due to error detection of %2.                                       | relation stop failure              | Check the status of resources.                  | •     | •         | •        |             |           |                |         | • |
| rm          | Error       | 1519     | Failed to restart %1 due to error detection of %2.                                    | relation restart failure           | Check the status of resources.                  | •     | •         | •        |             |           |                |         | • |
| rm          | Error       | 1520     | Failed to fail over %1 due to error detection of %2.                                  | relation group failover failure    | Check the status of resources.                  | •     | •         | •        |             |           |                |         | • |
| rm          | Error       | 1521     | Failed to stop the cluster due to error detection of %1.                              | cluster stop failure               | The system may not be able to operate properly. | •     | •         | •        |             |           |                |         | • |
| rm          | Error       | 1522     | Failed to shut down the system due to error detection of %1.                          | os shutdown failure                | The system may not be able to operate properly. | •     | •         | •        |             |           |                |         | • |

| Module Type | Event Type  | Event ID | Messages                                                                        | Description                              | Solution                                                                                                                                                                                                                  | Alert | Event log | User log | Mail report | SNMP Trap | Report setting |         |
|-------------|-------------|----------|---------------------------------------------------------------------------------|------------------------------------------|---------------------------------------------------------------------------------------------------------------------------------------------------------------------------------------------------------------------------|-------|-----------|----------|-------------|-----------|----------------|---------|
|             |             |          |                                                                                 |                                          |                                                                                                                                                                                                                           |       |           |          |             |           | Alive          | Manager |
| rm          | Error       | 1523     | Failed to restart the system due to error detection of %1.                      | os reboot failure                        | The system may not be able to operate properly.                                                                                                                                                                           | •     | •         | •        |             |           |                | •       |
| rm          | Error       | 1524     | The group of monitor %1 is unknown.                                             | unknown group                            | Check the cluster configuration data.                                                                                                                                                                                     | •     | •         | •        |             |           |                | •       |
| rm          | Warning     | 1525     | No action is taken because %1 is not online.                                    | not perform failure action               | -                                                                                                                                                                                                                         | •     | •         | •        |             |           |                | •       |
| rm          | Information | 1526     | Status of monitor %1 was returned to normal.                                    | status changed into normal               | -                                                                                                                                                                                                                         | •     | •         | •        |             |           |                |         |
| rm          | Information | 1527     | Status of monitor %1 was changed into unknown.                                  | status changed into unknown              | The system may not be able to operate properly.                                                                                                                                                                           | •     | •         | •        |             |           |                |         |
| rm          | Error       | 1528     | Initialization error has occurred (%1 : %2)                                     | process initialize error                 | The system may not be able to operate properly.                                                                                                                                                                           | •     | •         | •        |             |           |                | •       |
| rm          | Information | 1529     | Monitor %1 was suspended.                                                       | suspend (single monitor)                 | -                                                                                                                                                                                                                         | •     | •         | •        |             |           |                |         |
| rm          | Information | 1530     | Monitor %1 was resumed.                                                         | resume (single monitor)                  | -                                                                                                                                                                                                                         | •     | •         | •        |             |           |                |         |
| rm          | Information | 1531     | All monitors were suspended.                                                    | suspend (all monitors)                   | -                                                                                                                                                                                                                         | •     | •         | •        |             |           |                |         |
| rm          | Information | 1532     | All monitors were resumed.                                                      | resume (all monitors)                    | -                                                                                                                                                                                                                         | •     | •         | •        |             |           |                |         |
| rm          | Information | 1533     | The polling interval of monitor %1 was changed into %2*%3.                      | change polling interval (single monitor) | -                                                                                                                                                                                                                         | •     | •         | •        |             |           |                |         |
| rm          | Information | 1534     | The polling interval ratio of all monitors were changed into %1.                | change polling interval (all monitors)   | -                                                                                                                                                                                                                         | •     | •         | •        |             |           |                |         |
| rm          | Information | 1535     | Causing intentional stop error was required because an error is detected by %1. | intentional panic                        | -                                                                                                                                                                                                                         | •     | •         | •        |             |           |                |         |
| rm          | Error       | 1536     | Causing intentional stop error has failed because an error is detected by %1.   | intentional panic failure                | The system may not be able to operate properly.                                                                                                                                                                           | •     | •         | •        |             |           |                | •       |
| rm          | Warning     | 1537     | Recovery will not be executed since server is suspending.                       | not recovery(server suspending)          | Monitor resource is not recovered if the server is suspended (Network Partition Unsolved). Check the cause for being suspended (Network Partition Unsolved) and recover network partition resources to the normal status. | •     | •         | •        |             |           |                | •       |
| rm          | Warning     | 1538     | Recovery will not be executed since none of the recovery targets is active.     | not recovery (all groups)                | -                                                                                                                                                                                                                         | •     | •         | •        |             |           |                |         |
| rm          | Warning     | 1571     | Monitor %1 was delayed. (timeout=%2, response time=%3, rate=%4)                 | monitor delayed                          | Check the load on the server where monitoring delay was detected and reduce the load. Set longer timeout if the monitoring timeout is detected.                                                                           | •     | •         | •        |             |           |                | •       |

Messages reported by event log and alert

| Module Type | Event Type  | Event ID | Messages                                                                                                                              | Description                                                          | Solution                  | Alert | Event log | User log | Mail report | SNMP Trap | Report setting |         |
|-------------|-------------|----------|---------------------------------------------------------------------------------------------------------------------------------------|----------------------------------------------------------------------|---------------------------|-------|-----------|----------|-------------|-----------|----------------|---------|
|             |             |          |                                                                                                                                       |                                                                      |                           |       |           |          |             |           | Alive          | Manager |
| rm          | Warning     | 1600     | Shutdown count reached the maximum number (%1). Final action of monitor %2 was ignored.                                               | reached OS shutdown limit                                            | -                         | •     | •         | •        | •           | •         |                | •       |
| rm          | Warning     | 1601     | Since there is no other normally running server, the final action (%1) for the error detection of monitor resource %2 was suppressed. | Suppression of final action for error detection                      | -                         | •     | •         | •        |             |           |                |         |
| rm          | Information | 1700     | Script before action(%1) upon failure in %2 monitor resource started.                                                                 | Script before final action upon monitor resource failure started.    | -                         | •     | •         | •        |             |           |                |         |
| rm          | Information | 1701     | Script before action(%1) upon failure in %2 monitor resource completed.                                                               | Script before final action upon monitor resource failure completed.  | -                         | •     | •         | •        |             |           |                |         |
| rm          | Information | 1720     | Script before action(%1) upon failure in %2 monitor resource failed.                                                                  | Script before final action upon monitor resource failure has failed. | -                         | •     | •         | •        |             |           |                |         |
| rm          | Information | 1750     | The collecting of detailed information triggered by monitoring %1 error has been started (timeout=%2).                                | The collecting of detailed information has been started.             | -                         | •     | •         | •        |             |           |                |         |
| rm          | Information | 1751     | The collection of detailed information triggered by monitoring %1 error has been completed.                                           | The collection of detailed information has been completed.           | -                         | •     | •         | •        |             |           |                |         |
| rm          | Information | 1752     | The collection of detailed information triggered by monitoring %1 error has been failed (%2).                                         | The collection of detailed information has been failed.              | -                         | •     | •         | •        |             |           |                |         |
| rm          | Information | 1800     | The %1 service will be started by cluster system.                                                                                     | start service                                                        | -                         | •     | •         | •        |             |           |                |         |
| rm          | Information | 1801     | The %1 service will be started again because the service has been stopped by cluster system. (retry: %2/%3)                           | start service (retry)                                                | -                         | •     | •         | •        |             |           |                |         |
| rm          | Information | 1802     | The %1 service will be resumed by cluster system.                                                                                     | resume service                                                       | -                         | •     | •         | •        |             |           |                |         |
| rm          | Information | 1803     | The %1 service will be resumed again because the service has been suspended by cluster system. (retry: %2/%3)                         | resume service (retry)                                               | -                         | •     | •         | •        |             |           |                |         |
| rm          | Information | 1804     | The %1 service will be stopped by cluster system.                                                                                     | stop service                                                         | -                         | •     | •         | •        |             |           |                |         |
| rm          | Information | 1805     | The %1 service entered the running state.                                                                                             | service running                                                      | -                         | •     | •         | •        |             |           |                |         |
| rm          | Information | 1806     | The %1 service entered the stopped state.                                                                                             | service stopped                                                      | -                         | •     | •         | •        |             |           |                |         |
| rm          | Warning     | 1811     | Start request of the %1 service failed. Check the service status.                                                                     | failed to start service                                              | Check the service status. | •     | •         | •        |             |           |                |         |
| rm          | Warning     | 1812     | Resume request of the %1 service failed. Check the service status.                                                                    | failed to resume service                                             | Check the service status. | •     | •         | •        |             |           |                |         |

| Module Type | Event Type  | Event ID | Messages                                                                                     | Description                                              | Solution                                                          | Alert | Event log | User log | Mail report | SNMP Trap | Report setting |         |  |
|-------------|-------------|----------|----------------------------------------------------------------------------------------------|----------------------------------------------------------|-------------------------------------------------------------------|-------|-----------|----------|-------------|-----------|----------------|---------|--|
|             |             |          |                                                                                              |                                                          |                                                                   |       |           |          |             |           | Alive          | Manager |  |
| rm          | Warning     | 1813     | Stop request of the %1 service failed. Check the service status.                             | failed to stop the service                               | Check the service status.                                         | •     | •         | •        |             |           |                |         |  |
| rm          | Warning     | 1816     | The %1 service has been stopped by other than cluster system.                                | service stopped (error)                                  | Check the cause of the service stopped.                           | •     | •         | •        |             |           |                |         |  |
| rm          | Warning     | 1817     | The %1 service has been suspended by other than cluster system.                              | service suspended (error)                                | Check the cause of the service suspended.                         | •     | •         | •        |             |           |                |         |  |
| rm          | Warning     | 1819     | Start or resume retry count for the %1 service exceeded the threshold (%2).                  | start or resume retry count exceeded the threshold       | -                                                                 | •     | •         | •        |             |           |                |         |  |
| rm          | Information | 1820     | The cluster will be stopped because there was a failure in %1 service monitoring.            | cluster stop (failure in service monitoring)             | -                                                                 | •     | •         | •        |             |           |                |         |  |
| rm          | Information | 1821     | The system will be shut down because there was a failure in %1 service monitoring.           | system shut down (failure in service monitoring)         | -                                                                 | •     | •         | •        |             |           |                |         |  |
| rm          | Information | 1822     | The cluster will be rebooted because there was a failure in %1 service monitoring.           | system reboot (failure in service monitoring)            | -                                                                 | •     | •         | •        |             |           |                |         |  |
| rm          | Error       | 1870     | Monitor resource %1 can not be controlled because the license is invalid.                    | cannot control monitor (invalid license)                 | Check if the license is registered or the license is valid.       | •     | •         | •        |             |           |                |         |  |
| rm          | Information | 1890     | Recovery script has executed because an error was detected in monitoring %1.                 | Recovery script upon monitor resource failure executed   |                                                                   | •     | •         | •        |             |           |                |         |  |
| rm          | Error       | 1891     | Attempted to execute recovery script due to the error detected in monitoring %1, but failed. | failed to execute recovery script                        | Check the cause of the recovery script failure and take measures. | •     | •         | •        |             |           |                |         |  |
| rm          | Information | 1910     | Dummy Failure of monitor resource %1 is enabled.                                             | enable dummy failure                                     | -                                                                 | •     | •         | •        |             |           |                |         |  |
| rm          | Information | 1911     | Dummy Failure of monitor resource %1 is disabled.                                            | disable dummy failure                                    | -                                                                 | •     | •         | •        |             |           |                |         |  |
| rm          | Information | 1912     | Dummy Failure of all monitors will be enabled.                                               | enable dummy failure (all monitors)                      | -                                                                 | •     | •         | •        |             |           |                |         |  |
| rm          | Information | 1913     | Dummy Failure of all monitors will be disabled.                                              | disable dummy failure (all monitors)                     | -                                                                 | •     | •         | •        |             |           |                |         |  |
| rm          | Warning     | 1914     | An attempt was made to enable Dummy Failure of monitor resource %1, but failed.              | failed to enable dummy failure                           | -                                                                 | •     | •         | •        |             |           |                |         |  |
| rm          | Warning     | 1915     | An attempt was made to disable Dummy Failure of monitor resource %1, but failed.             | failed to disable dummy failure                          | -                                                                 | •     | •         | •        |             |           |                |         |  |
| rm          | Information | 1930     | Recovery action caused by monitor resource error is disabled.                                | disable recovery action caused by monitor resource error | -                                                                 | •     | •         | •        |             |           |                |         |  |

Messages reported by event log and alert

| Module Type | Event Type  | Event ID | Messages                                                                                                                                                                | Description                                                                  | Solution                                        | Alert | Event log | User log | Mail report | SNMP Trap | Report setting |         |   |
|-------------|-------------|----------|-------------------------------------------------------------------------------------------------------------------------------------------------------------------------|------------------------------------------------------------------------------|-------------------------------------------------|-------|-----------|----------|-------------|-----------|----------------|---------|---|
|             |             |          |                                                                                                                                                                         |                                                                              |                                                 |       |           |          |             |           | Alive          | Manager |   |
| rm          | Information | 1931     | Recovery action caused by monitor resource error is enabled.                                                                                                            | enable recovery action caused by monitor resource error                      | -                                               | •     | •         | •        |             |           |                |         |   |
| rm          | Warning     | 1932     | Ignored the recovery action in monitoring %1 because recovery action caused by monitor resource error is disabled.                                                      | not recovery (recovery action caused by monitor resource error has disabled) | -                                               | •     | •         | •        |             |           |                |         |   |
| rm          | Warning     | 1933     | Recovery action at timeout occurrence was disabled, so the recovery action of monitor %1 was not executed.                                                              | disable recovery action caused by monitor resource timeout                   | -                                               | •     | •         | •        |             |           |                |         |   |
| diskagent   | Information | 2001     | %1 service was started.                                                                                                                                                 | Start service                                                                | -                                               |       | •         | •        |             |           |                |         |   |
| diskagent   | Information | 2002     | %1 service was stopped.                                                                                                                                                 | Stop service                                                                 | -                                               |       | •         | •        |             |           |                |         |   |
| diskagent   | Warning     | 2030     | %1 service was not stopped successfully due to stop timeout or other errors of the internal threads.                                                                    | Fail to stop service                                                         | The system may not be able to operate properly. | •     | •         | •        |             |           |                |         | • |
| diskagent   | Error       | 2050     | %1 service was not started successfully because the specified parameter was invalid. Confirm the cluster configuration data.                                            | Fail to start service                                                        | Check the cluster configuration data.           | •     | •         | •        |             |           |                |         | • |
| diskagent   | Error       | 2051     | %1 service was not started because obtaining the policy data failed. Check the data.                                                                                    | Fail to start service                                                        | Check the policy file.                          | •     | •         | •        |             |           |                |         | • |
| diskagent   | Error       | 2052     | %1 service was not started successfully because dispatching to service manager failed. System may be unable to operate correctly.                                       | Fail to start service                                                        | The system may not be able to operate properly. | •     | •         | •        |             |           |                |         | • |
| diskagent   | Error       | 2053     | %1 service was not started successfully because creating and loading internal resources failed. System may be unable to operate correctly.                              | Fail to start service                                                        | System may be unable to operate correctly.      | •     | •         | •        |             |           |                |         | • |
| diskagent   | Error       | 2054     | %1 service was not started successfully because initialization of shared disk or mirror disk library failed at exit code %2. System may be unable to operate correctly. | Fail to start service                                                        | The system may not be able to operate properly. | •     | •         | •        |             |           |                |         | • |
| diskagent   | Error       | 2055     | %1 service was not started successfully because creating communication socket failed. System may be unable to operate correctly.                                        | Fail to start service                                                        | The system may not be able to operate properly. | •     | •         | •        |             |           |                |         | • |

| Module Type | Event Type  | Event ID | Messages                                                                                                                             | Description                 | Solution                                        | Alert | Event log | User log | Mail report | SNMP Trap | Report setting |         |
|-------------|-------------|----------|--------------------------------------------------------------------------------------------------------------------------------------|-----------------------------|-------------------------------------------------|-------|-----------|----------|-------------|-----------|----------------|---------|
|             |             |          |                                                                                                                                      |                             |                                                 |       |           |          |             |           | Alive          | Manager |
| diskagent   | Error       | 2056     | %1 service was not started successfully because creating internal threads failed. System may be unable to operate successfully.      | Fail to start service       | The system may not be able to operate properly. | •     | •         | •        |             |           |                | •       |
| diskagent   | Error       | 2057     | %1 service was not started because it may be stopped or forcibly stopped last time when it was started. Reboot the server.           | Fail to start service       | Reboot the server.                              | •     | •         | •        |             |           |                | •       |
| diskagent   | Error       | 2090     | %1 service failed to reload cluster configuration data. System may be unable to operate correctly. The own server will be shut down. | Server shutdown             | The system may not be able to operate properly. | •     | •         | •        |             |           |                | •       |
| diskagent   | Error       | 2099     | %1 service was not started successfully because the other internal error occurred. System may be unable to operate correctly.        | Fail to start service       | The system may not be able to operate properly. | •     | •         | •        |             |           |                | •       |
| event       | Information | 2101     | %1 service has been started.                                                                                                         | Start service               | -                                               |       | •         |          |             |           |                |         |
| event       | Information | 2102     | %1 service has been stopped.                                                                                                         | Stop service                | -                                               |       | •         |          |             |           |                |         |
| event       | Warning     | 2130     | Timeout or other error has occurred while waiting for internal threads to stop. Detected internal error %1.                          | Threads were timeout        | The system may not be able to operate properly. | •     | •         |          |             |           |                | •       |
| event       | Error       | 2150     | The specified parameters are invalid. Check the cluster configuration data.                                                          | Invalid configuration       | Check the cluster configuration data.           | •     | •         |          |             |           |                | •       |
| event       | Error       | 2151     | Failed to obtain the policy data. Check the data.                                                                                    | Invalid configuration       | Check the policy file.                          | •     | •         |          |             |           |                | •       |
| event       | Error       | 2152     | Failed to obtain the registry data. System may be unable to operate correctly.                                                       | Failed to read registry     | The system may not be able to operate properly. | •     | •         |          |             |           |                | •       |
| event       | Error       | 2153     | Failed to dispatch to the service manager. System may be unable to operate correctly.                                                | Dispatch failed             | The system may not be able to operate properly. | •     | •         |          |             |           |                | •       |
| event       | Error       | 2154     | Failed to create an internal resource. System may be unable to operate correctly.                                                    | failed to resource creation | The system may not be able to operate properly. | •     | •         |          |             |           |                | •       |
| event       | Error       | 2155     | Failed to create communication sockets. System may be unable to operate correctly.                                                   | failed to socket creation   | The system may not be able to operate properly. | •     | •         |          |             |           |                | •       |

Messages reported by event log and alert

| Module Type | Event Type  | Event ID | Messages                                                                                              | Description                                                     | Solution                                                             | Alert | Event log | User log | Mail report | SNMP Trap | Report setting |         |   |
|-------------|-------------|----------|-------------------------------------------------------------------------------------------------------|-----------------------------------------------------------------|----------------------------------------------------------------------|-------|-----------|----------|-------------|-----------|----------------|---------|---|
|             |             |          |                                                                                                       |                                                                 |                                                                      |       |           |          |             |           | Alive          | Manager |   |
| event       | Error       | 2156     | Failed to control the shared memory. System may be unable to operate correctly.                       | failed to shared memory control                                 | The system may not be able to operate properly.                      | •     | •         |          |             |           |                |         | • |
| event       | Error       | 2157     | Failed to generate internal threads. System may be unable to operate correctly.                       | failed to thread creation                                       | The system may not be able to operate properly.                      | •     | •         |          |             |           |                |         | • |
| event       | Error       | 2199     | Other internal error has occurred. System may be unable to operate correctly.                         | Internal Error                                                  | The system may not be able to operate properly.                      | •     | •         |          |             |           |                |         | • |
| trnsv       | Error       | 2301     | There was a notification from external (IP=%1), but it was denied.                                    | Connection limit by client IP address                           | Check the client IP address from which the connection is permitted.  | •     | •         | •        |             |           |                |         |   |
| trnsv       | Information | 2310     | There was a notification (%1) from external (IP=%2).                                                  | Received an abnormality occurrence notification from outside    | -                                                                    | •     | •         | •        |             |           |                |         |   |
| trnsv       | Information | 2320     | Recovery action (%1) of monitoring %2 has been executed because a notification arrived from external. | Executed the recovery action at abnormality occurrence          | -                                                                    | •     | •         | •        |             |           |                |         |   |
| trnsv       | Information | 2321     | Recovery action (%1) of monitoring %2 has been completed.                                             | Completed the recovery action at abnormality occurrence         | -                                                                    | •     | •         | •        |             |           |                |         |   |
| trnsv       | Error       | 2322     | Attempted to recovery action (%1) of monitoring %2 due to the notification from external, but failed. | Failed to execute the recovery action at abnormality occurrence | Make sure that the recovery action on the environment is executable. | •     | •         | •        |             |           |                |         |   |
| trnsv       | Information | 2330     | Action (%1) has been completed.                                                                       | The requested action completed                                  | -                                                                    | •     | •         | •        |             |           |                |         |   |
| trnsv       | Error       | 2331     | Attempted to execute action (%1), but it failed.                                                      | The requested action Failed                                     | Make sure that the recovery action is an executable environment.     | •     | •         | •        |             |           |                |         |   |
| trnsv       | Information | 2340     | Script before action of monitoring %1 has been executed.                                              | Script execution started                                        | -                                                                    | •     | •         | •        |             |           |                |         |   |
| trnsv       | Information | 2341     | Script before action of monitoring %1 has been completed.                                             | Script execution completed                                      | -                                                                    | •     | •         | •        |             |           |                |         |   |
| trnsv       | Error       | 2342     | Attempted to execute script before action of monitoring %1, but it failed.                            | Script execution failed                                         | Handle the problem after making sure the cause of script failure.    | •     | •         | •        |             |           |                |         |   |
| trnsv       | Error       | 2350     | The system will be shutdown because cluster resume was failed.                                        | Failed to resume the cluster daemon                             | -                                                                    | •     | •         | •        |             |           |                |         |   |

| Module Type | Event Type  | Event ID | Messages                                                                                                            | Description                                    | Solution                                                                                            | Alert | Event log | User log | Mail report | SNMP Trap | Report setting |         |   |
|-------------|-------------|----------|---------------------------------------------------------------------------------------------------------------------|------------------------------------------------|-----------------------------------------------------------------------------------------------------|-------|-----------|----------|-------------|-----------|----------------|---------|---|
|             |             |          |                                                                                                                     |                                                |                                                                                                     |       |           |          |             |           | Alive          | Manager |   |
| trnsv       | Error       | 2351     | An attempt to shutdown the system failed.                                                                           | Failed to shutdown the system                  | The system may not be able to operate properly.                                                     | •     | •         | •        |             |           |                |         |   |
| mdadm       | Information | 2401     | Full Recovery of mirror disk %1 started.                                                                            | Full Recovery of mirror disk started           | -                                                                                                   | •     | •         | •        |             |           |                |         |   |
| mdadm       | Information | 2402     | Full Recovery of mirror disk %1 finished successfully.                                                              | Full Recovery of mirror disk succeeded         | -                                                                                                   | •     | •         | •        |             |           |                |         |   |
| mdadm       | Information | 2403     | Full Recovery of mirror disk %1 was canceled.                                                                       | Full Recovery of mirror disk was canceled.     | -                                                                                                   | •     | •         | •        |             |           |                |         |   |
| mdadm       | Error       | 2404     | Full Recovery of mirror disk %1 failed.                                                                             | Full Recovery of mirror disk failed.           | Make sure there is no error in the disk and network adapter and the network is correctly connected. | •     | •         | •        |             |           |                | •       | • |
| mdadm       | Information | 2405     | Fast Recovery of mirror disk %1 started.                                                                            | Fast Recovery of mirror disk started           | -                                                                                                   | •     | •         | •        |             |           |                |         |   |
| mdadm       | Information | 2406     | Fast Recovery of mirror disk %1 finished successfully.                                                              | Fast Recovery of mirror disk succeeded         | -                                                                                                   | •     | •         | •        |             |           |                |         |   |
| mdadm       | Information | 2407     | Fast Recovery of mirror disk %1 was canceled.                                                                       | Fast Recovery of mirror disk was canceled      | -                                                                                                   | •     | •         | •        |             |           |                |         |   |
| mdadm       | Error       | 2408     | Fast Recovery of mirror disk %1 failed.                                                                             | Fast Recovery of mirror disk failed            | Make sure there is no error in the disk and network adapter and the network is correctly connected. | •     | •         | •        |             |           |                | •       | • |
| mdadm       | Warning     | 2411     | Trying again to disconnect mirror disk %1. Check if the mirror disk is being used.                                  | Disconnection of mirror disk is being retried. | Check if the mirror disk is being used.                                                             | •     | •         | •        |             |           |                |         | • |
| mdadm       | Information | 2412     | Mirror disk %1 was forcibly disconnected.                                                                           | mirror disk was forcibly disconnected.         | -                                                                                                   | •     | •         | •        |             |           |                |         |   |
| mdadm       | Error       | 2421     | The mirror connect of the mirror disk %1 has been disconnected.                                                     | Mirror connect error.                          | Make sure there is no error in the network adapter and the network is correctly connected.          | •     | •         | •        |             |           |                |         | • |
| mdadm       | Error       | 2422     | A data partition error occurred in the mirror disk %1.                                                              | mirror disk abnormal                           | Replace the server disk.                                                                            | •     | •         | •        |             |           |                | •       | • |
| mdadm       | Error       | 2423     | A cluster partition error occurred in the mirror disk %1.                                                           | Disk error                                     | Replace the server disk.                                                                            | •     | •         | •        |             |           |                | •       | • |
| mdadm       | Error       | 2431     | Failed to initialize the mirror connect.                                                                            | Mirror connection initialization failed.       | Make sure there is no error in the network adapter and the network is correctly connected.          | •     | •         | •        |             |           |                | •       | • |
| mdadm       | Error       | 2432     | Failed to initialize the mirror disk %1.                                                                            | Mirror disk initialization failed.             | Check the partition exists and the disk is recognized by the operating system.                      | •     | •         | •        |             |           |                | •       | • |
| mdadm       | Error       | 2433     | Failed to initialize the mirror disk %1. The cluster partition and the data partition must be different partitions. | Mirror disk initialization failed.             | Check the cluster configuration data.                                                               | •     | •         | •        |             |           |                |         | • |
| mdadm       | Error       | 2434     | Failed to initialize the mirror disk %1. The area in the cluster partition has been used by another mirror disk.    | Mirror disk initialization failed.             | Check the cluster configuration data.                                                               | •     | •         | •        |             |           |                |         | • |



Messages reported by event log and alert

| Module Type | Event Type  | Event ID | Messages                                                                                                                                               | Description                                                                                              | Solution                                                                                   | Alert | Event log | User log | Mail report | SNMP Trap | Report setting |         |
|-------------|-------------|----------|--------------------------------------------------------------------------------------------------------------------------------------------------------|----------------------------------------------------------------------------------------------------------|--------------------------------------------------------------------------------------------|-------|-----------|----------|-------------|-----------|----------------|---------|
|             |             |          |                                                                                                                                                        |                                                                                                          |                                                                                            |       |           |          |             |           | Alive          | Manager |
| mdadm       | Error       | 2435     | Failed to initialize the mirror disk %1. The partition specified for the cluster partition has been used as the data partition of another mirror disk. | Mirror disk initialization failed.                                                                       | Check the cluster configuration data.                                                      | •     | •         | •        |             |           |                | •       |
| mdadm       | Error       | 2436     | Failed to initialize the mirror disk %1. The partition specified for the data partition has been used by another mirror disk.                          | Mirror disk initialization failed.                                                                       | Check the cluster configuration data.                                                      | •     | •         | •        |             |           |                | •       |
| mdadm       | Error       | 2440     | Connecting mirror disk %1 has failed.                                                                                                                  | Connecting mirror disk failed.                                                                           | Check the partition exists and the disk is recognized by the operating system.             |       | •         |          |             |           |                | •       |
| mdadm       | Error       | 2441     | Disconnecting mirror disk %1 has failed.                                                                                                               | Disconnecting mirror disk failed.                                                                        | Check if the mirror disk is being used.                                                    |       | •         |          |             |           |                | •       |
| mdadm       | Warning     | 2442     | The mirror disk connect of mirror disk %1 has been changed.                                                                                            | The mirror disk connect has been switched due to disconnection of the active mirror disk connect.        | Make sure there is no error in the network adapter and the network is correctly connected. | •     | •         | •        |             |           |                |         |
| mdadm       | Error       | 2443     | Disconnecting mirror disk %1 has failed while it is being copied. The server is shut down to protect data.                                             | Failed sending server closing due to process access<br>Execution of emergency shutdown by process access | The mirror disk may be in use. Check the mirror disk.                                      | •     | •         | •        |             |           |                | •       |
| lankhb      | Error       | 2851     | Keep-alive timeout was detected on the server %1.                                                                                                      | Keep-alive timeout                                                                                       | There is a server where keep-alive timeout is detected. Check the server error.            | •     | •         |          |             |           |                | •       |
| fip         | Error       | 2901     | IP address already exists. (IP=%1)                                                                                                                     | address duplication                                                                                      | -                                                                                          | •     | •         | •        |             |           |                |         |
| fip         | Information | 2902     | IP address will be activated forcibly. (IP=%1)                                                                                                         | address force activation                                                                                 | -                                                                                          | •     | •         | •        |             |           |                |         |
| vip         | Error       | 3051     | IP address already exists. (IP=%1)                                                                                                                     | address duplication                                                                                      | -                                                                                          | •     | •         | •        |             |           |                |         |
| vip         | Information | 3052     | IP address will be activated forcibly. (IP=%1)                                                                                                         | address force activation                                                                                 | -                                                                                          | •     | •         | •        |             |           |                |         |
| sdfunc      | Warning     | 3201     | Trying again to disconnect disk %1. Check if the disk is being used.                                                                                   | Retry disk disconnection                                                                                 | Check if the disk is being used.                                                           | •     | •         | •        |             |           |                | •       |
| sdfunc      | Information | 3202     | Disk %1 was forcibly disconnected.                                                                                                                     | Disconnect disk forcibly                                                                                 | -                                                                                          | •     | •         | •        |             |           |                |         |

| Module Type | Event Type  | Event ID | Messages                                                                                                                                 | Description                         | Solution                                                                                                                                                                                                                                                   | Alert | Event log | User log | Mail report | SNMP Trap | Report setting | Manager |
|-------------|-------------|----------|------------------------------------------------------------------------------------------------------------------------------------------|-------------------------------------|------------------------------------------------------------------------------------------------------------------------------------------------------------------------------------------------------------------------------------------------------------|-------|-----------|----------|-------------|-----------|----------------|---------|
|             |             |          |                                                                                                                                          |                                     |                                                                                                                                                                                                                                                            |       |           |          |             |           | Alive          | Alive   |
| sdfunc      | Warning     | 3203     | Updated configuration data was not reflected properly. Update the configuration data again after modifying the configuration settings.   | Fail to update configuration        | Check whether the cluster configuration information, specifically the HBA setting and the letter of the drive and GUID data for the disk NP resolution resource and disk resources for each server, matches the current disk configuration of each server. | •     | •         | •        |             |           |                | •       |
| sdfunc      | Warning     | 3204     | The server %1 is not found in the configuration data. Check the server name of the configuration data.                                   | Fail to detect server name          | Check the cluster configuration data.                                                                                                                                                                                                                      | •     | •         | •        |             |           |                | •       |
| sdfunc      | Information | 3205     | Detected disk resources that have not been identified. Disk reidentification will be executed.                                           | Execute disk reconfirmation         | -                                                                                                                                                                                                                                                          | •     | •         | •        |             |           |                |         |
| sdfunc      | Information | 3206     | Reidentification of the disk has finished.                                                                                               | Finish disk reconfirmation          | -                                                                                                                                                                                                                                                          | •     | •         | •        |             |           |                |         |
| sdfunc      | Error       | 3207     | Connecting disk %1 has failed.                                                                                                           | Fail to connect disk                | Check if the partition is allocated and the disk is being recognized by operating system.                                                                                                                                                                  |       | •         |          |             |           |                | • •     |
| sdfunc      | Error       | 3208     | Disconnecting disk %1 has failed.                                                                                                        | Fail to disconnect disk             | Check if the disk is being used.                                                                                                                                                                                                                           |       | •         |          |             |           |                | •       |
| disknp      | Warning     | 3251     | Timeout has occurred in read/write to the partition for disk heartbeat. Check the connection status of partition for disk heartbeat.     | Disk heart beat timeout             | Make sure there is no error in the disk and it is correctly connected .                                                                                                                                                                                    | •     | •         | •        |             |           |                | • •     |
| disknp      | Information | 3252     | Recovered from the timeout occurred in read/write to the partition for disk heartbeat.                                                   | Recover from disk heartbeat timeout | -                                                                                                                                                                                                                                                          | •     | •         | •        |             |           |                |         |
| disknp      | Error       | 3257     | Disconnection monitoring(%1) among the shared disk and the servers could not be started. The system may not be able to operate properly. | Fail to start monitoring            | The system may not be able to operate properly.                                                                                                                                                                                                            | •     | •         | •        |             |           |                | •       |
| ptun        | Warning     | 3301     | The parameter (%1) exceeded the threshold (%2 p.c.). Timeout value=%3(sec) Data=%4(sec)                                                  | Delay warning                       | The parameter exceeded the threshold. Set an appropriate value to the parameter.                                                                                                                                                                           | •     | •         | •        |             |           |                | •       |
| ptun        | Warning     | 3302     | The parameter (%1) exceeded the threshold (%2 p.c.). Timeout value=%3 Data=%4 Server=%5 Resource=%6                                      | Delay warning                       | The parameter exceeded the threshold. Set an appropriate value to the parameter.                                                                                                                                                                           | •     | •         | •        |             |           |                | •       |

Messages reported by event log and alert

| Module Type | Event Type | Event ID | Messages                                                                                                                                                                              | Description         | Solution                                       | Alert | Event log | User log | Mail report | SNMP Trap | Report setting |         |   |
|-------------|------------|----------|---------------------------------------------------------------------------------------------------------------------------------------------------------------------------------------|---------------------|------------------------------------------------|-------|-----------|----------|-------------|-----------|----------------|---------|---|
|             |            |          |                                                                                                                                                                                       |                     |                                                |       |           |          |             |           | Alive          | Manager |   |
| armcmd      | Error      | 3501     | ARMLOAD detected that the application (watchID=%2) of the group %1 has stopped. The number of failovers has reached the maximum count. Check what has caused the application to stop. | Application stopped | Check the cause for application to be stopped. | •     | •         |          |             |           |                |         | • |
| armcmd      | Error      | 3502     | ARMLOAD detected that the application (watchID=%2) of the group %1 has stopped. Script will be restarted. Check what has caused the application to stop.                              | Application stopped | Check the cause for application to be stopped. | •     | •         |          |             |           |                |         | • |
| armcmd      | Error      | 3503     | ARMLOAD detected that the application (watchID=%2) of the group %1 has stopped. The application will be restarted. Check what has caused the application to stop.                     | Application stopped | Check the cause for application to be stopped. | •     | •         |          |             |           |                |         | • |
| armcmd      | Error      | 3504     | ARMLOAD detected that the application (watchID=%2) of the group %1 has stopped. Group will be failed over. Check what has caused the application to stop.                             | Application stopped | Check the cause for application to be stopped. | •     | •         |          |             |           |                |         | • |
| armcmd      | Error      | 3505     | ARMLOAD detected that the application (watchID=%2) of the group %1 has stopped. The server will shut down. Check what has caused the application to stop.                             | Application stopped | Check the cause for application to be stopped. | •     | •         |          |             |           |                |         | • |
| armcmd      | Error      | 3506     | ARMLOAD detected that the service (watchID=%2) of the group %1 has stopped. The number of failovers has reached the maximum count. Check what has caused the application to stop.     | Service stopped     | Check the cause for service to be stopped.     | •     | •         |          |             |           |                |         | • |
| armcmd      | Error      | 3507     | ARMLOAD detected that the service (watchID=%2) of the group %1 has stopped. Script will be restarted. Check what has caused the application to stop.                                  | Service stopped     | Check the cause for service to be stopped.     | •     | •         |          |             |           |                |         | • |

| Module Type | Event Type  | Event ID | Messages                                                                                                                                                  | Description           | Solution                                                                                                                                                                                                                                                                     | Alert | Event log | User log | Mail report | SNMP Trap | Report setting |         |
|-------------|-------------|----------|-----------------------------------------------------------------------------------------------------------------------------------------------------------|-----------------------|------------------------------------------------------------------------------------------------------------------------------------------------------------------------------------------------------------------------------------------------------------------------------|-------|-----------|----------|-------------|-----------|----------------|---------|
|             |             |          |                                                                                                                                                           |                       |                                                                                                                                                                                                                                                                              |       |           |          |             |           | Alive          | Manager |
| armcmd      | Error       | 3508     | ARMLOAD detected that the service (watchID=%2) of the group %1 has stopped. The service will be restarted. Check what has caused the application to stop. | Service stopped       | Check the cause for service to be stopped.                                                                                                                                                                                                                                   | •     | •         |          |             |           |                | •       |
| armcmd      | Error       | 3509     | ARMLOAD detected that the service (watchID=%2) of the group %1 has stopped. The group will be failed over. Check what has caused the application to stop. | Service stopped       | Check the cause for service to be stopped.                                                                                                                                                                                                                                   | •     | •         |          |             |           |                | •       |
| armcmd      | Error       | 3510     | ARMLOAD detected that the service (watchID=%2) of the group %1 has stopped. The server will shut down. Check what has caused the application to stop.     | Service stopped       | Check the cause for service to be stopped.                                                                                                                                                                                                                                   | •     | •         |          |             |           |                | •       |
| armcmd      | Error       | 3513     | An error occurred in command %1. Shut down the server.                                                                                                    | Command error         | The system may not be able to operate properly.                                                                                                                                                                                                                              | •     | •         |          |             |           |                | •       |
| armcmd      | Warning     | 3514     | An abnormal connection to the shared name (%1) has been detected.                                                                                         | Share-name abnormally | The shared name cannot be used. Recover the devices that correspond to the shared name. (1) OS is unstable. Check the OS status. (2) Check if the power is supplied to the appropriate devices. (3) Check if the appropriate devices and the servers are connected properly. | •     | •         |          |             |           |                | •       |
| armcmd      | Information | 3515     | Connection to the shared name (%1) has been recovered.                                                                                                    | Share-name recovered  | -                                                                                                                                                                                                                                                                            | •     | •         |          |             |           |                |         |
| armcmd      | Warning     | 3516     | Failed to start the application (WID=%2) of the group %1.                                                                                                 | Application failed    | Check the cause for failing to start the application.                                                                                                                                                                                                                        | •     | •         |          |             |           |                | •       |
| armcmd      | Information | 3517     | The application (WID=%2) of the group %1 has restarted.                                                                                                   | Application restarted | -                                                                                                                                                                                                                                                                            | •     | •         |          |             |           |                |         |
| armcmd      | Warning     | 3518     | Failed to start the service (WID=%2) of the group %1.                                                                                                     | Service failed        | Check the cause for failing to start the service.                                                                                                                                                                                                                            | •     | •         |          |             |           |                | •       |
| armcmd      | Information | 3519     | The service (WID=%2) of the group %1 has restarted.                                                                                                       | Service restarted     | -                                                                                                                                                                                                                                                                            | •     | •         |          |             |           |                |         |
| armcmd      | Error       | 3520     | Failed to fail over the group %1. Check whether the server where the group can fail over exists.                                                          | Fail over failed      | There may not be a server where the group can fail over.                                                                                                                                                                                                                     | •     | •         |          |             |           |                | •       |

Messages reported by event log and alert

| Module Type | Event Type  | Event ID | Messages                                                                                                                       | Description                                  | Solution                                                                                                   | Alert | Event log | User log | Mail report | SNMP Trap | Report setting |         |   |
|-------------|-------------|----------|--------------------------------------------------------------------------------------------------------------------------------|----------------------------------------------|------------------------------------------------------------------------------------------------------------|-------|-----------|----------|-------------|-----------|----------------|---------|---|
|             |             |          |                                                                                                                                |                                              |                                                                                                            |       |           |          |             |           | Alive          | Manager |   |
| lcns        | Information | 3551     | The trial version is valid till %1/%2/%3. Product name:%4                                                                      | trial version(normal)                        | -                                                                                                          | •     | •         |          |             |           |                |         |   |
| lcns        | Error       | 3552     | The trial version has expired(%1/%2/%3). Product name:%4                                                                       | trial version(expired)                       | Register the license.                                                                                      | •     | •         | •        |             |           |                |         | • |
| lcns        | Warning     | 3553     | Licenses are insufficient. The number of registered licenses is %1. The number of insufficient licenses is %2. Product name:%3 | insufficient                                 | Register the license.                                                                                      | •     | •         |          |             |           |                |         | • |
| lcns        | Error       | 3554     | The license is not registered. Product name:%1                                                                                 | not registered                               | Register the license.                                                                                      | •     | •         | •        |             |           |                |         | • |
| lcns        | Error       | 3555     | The same license is registered with other servers. Product name:%1                                                             | repetition registered                        | Delete the overlapping license.                                                                            | •     | •         | •        |             |           |                |         | • |
| lcns        | Error       | 3556     | Manufacturer or model of this server is invalid.                                                                               | Invalid manufacturer or model                | Confirm the manufacturer or model.                                                                         | •     | •         | •        |             |           |                |         | • |
| logcmd      | Information | 3601     |                                                                                                                                | log command                                  | -                                                                                                          | •     | -         | -        | -           | -         | -              | -       | - |
| sdw/hdw     | Warning     | 3651     | Monitor %1 was delayed. (timeout=%2 response time=%3 rate=%4)                                                                  | Monitoring is delayed                        |                                                                                                            | •     | •         | •        |             |           |                |         | • |
| sdw/hdw     | Error       | 3652     | Cannot access the disk (%1).                                                                                                   | Disconnection is detected.                   | Make sure there is no error in the disk and the shared disk is correctly connected.                        |       | •         |          |             |           |                |         | • |
| sdw/hdw     | Information | 3653     | Recovered the status where access to the disk (%1) is possible.                                                                | Recovery from disconnection has been done.   | -                                                                                                          |       | •         |          |             |           |                |         |   |
| diskw       | Warning     | 3701     | Monitor %1 was delayed. (timeout=%2 response time=%3 rate=%4)                                                                  | monitor delayed                              |                                                                                                            | •     | •         | •        |             |           |                |         | • |
| userw       | Warning     | 3711     | Monitor %1 was delayed. (timeout=%2 response time=%3 rate=%4)                                                                  | monitor delayed                              |                                                                                                            | •     | •         | •        |             |           |                |         | • |
| vcom        | Error       | 3751     | Failed to register the virtual computer name (%1) to the DNS server.                                                           | Failed to register the virtual computer name | Make sure there is no error on the DNS server, or a trouble occurred in communicating with the DNS server. | •     | •         |          |             |           |                |         |   |
| vcom        | Error       | 3752     | Failed to delete the virtual computer name (%1) from the DNS server.                                                           | Failed to delete the virtual computer name   | Make sure there is no error on the DNS server, or a trouble occurred in communicating with the DNS server. | •     | •         |          |             |           |                |         |   |
| hdadm       | Information | 3851     | Full Recovery of hybrid disk %1 started.                                                                                       | Full Recovery of hybrid disk started         | -                                                                                                          | •     | •         | •        |             |           |                |         |   |
| hdadm       | Information | 3852     | Full Recovery of hybrid disk %1 finished successfully.                                                                         | Full Recovery of hybrid disk succeeded       | -                                                                                                          | •     | •         | •        |             |           |                |         |   |
| hdadm       | Information | 3853     | Full Recovery of hybrid disk %1 was canceled.                                                                                  | Full Recovery of hybrid disk was canceled    | -                                                                                                          | •     | •         | •        |             |           |                |         |   |

| Module Type  | Event Type  | Event ID | Messages                                                                                                                                               | Description                                   | Solution                                                                                            | Alert | Event log | User log | Mail report | SNMP Trap | Report setting |         |   |
|--------------|-------------|----------|--------------------------------------------------------------------------------------------------------------------------------------------------------|-----------------------------------------------|-----------------------------------------------------------------------------------------------------|-------|-----------|----------|-------------|-----------|----------------|---------|---|
|              |             |          |                                                                                                                                                        |                                               |                                                                                                     |       |           |          |             |           | Alive          | Manager |   |
| hdadm        | Error       | 3854     | Full Recovery of hybrid disk %1 failed.                                                                                                                | Full Recovery of hybrid disk failed           | Make sure there is no error in the disk and network adapter and the network is correctly connected. | •     | •         | •        |             |           |                | •       | • |
| hdadm        | Information | 3855     | Fast Recovery of hybrid disk %1 started.                                                                                                               | Fast Recovery of hybrid disk started          | -                                                                                                   | •     | •         | •        |             |           |                |         |   |
| hdadm        | Information | 3856     | Fast Recovery of hybrid disk %1 finished successfully.                                                                                                 | Fast Recovery of hybrid disk succeeded        | -                                                                                                   | •     | •         | •        |             |           |                |         |   |
| hdadm        | Information | 3857     | Fast Recovery of hybrid disk %1 was canceled.                                                                                                          | Fast Recovery of hybrid disk was canceled     | -                                                                                                   | •     | •         | •        |             |           |                |         |   |
| hdadm        | Error       | 3858     | Fast Recovery of hybrid disk %1 failed.                                                                                                                | Fast Recovery of hybrid disk failed           | Make sure there is no error in the disk and network adapter and the network is correctly connected. | •     | •         | •        |             |           |                | •       | • |
| hdadm/hdfunc | Warning     | 3859     | Trying again to disconnect hybrid disk %1. Check if the hybrid disk is being used.                                                                     | Disconnection of hybrid disk is being retried | Check if the hybrid disk is being used.                                                             | •     | •         | •        |             |           |                |         | • |
| hdadm/hdfunc | Information | 3860     | Hybrid disk %1 was forcibly disconnected.                                                                                                              | Hybrid disk was forcibly disconnected.        | -                                                                                                   | •     | •         | •        |             |           |                |         |   |
| hdadm        | Error       | 3861     | The mirror connect of the hybrid disk %1 has been disconnected.                                                                                        | mirror connect error                          | Make sure there is no error in the network adapter and the network is correctly connected.          | •     | •         | •        |             |           |                |         | • |
| hdadm        | Error       | 3862     | A data partition error occurred in the hybrid disk %1.                                                                                                 | disk error                                    | Replace the server disk.                                                                            | •     | •         | •        |             |           |                | •       | • |
| hdadm        | Error       | 3863     | A cluster partition error occurred in the hybrid disk %1.                                                                                              | disk error                                    | Replace the server disk.                                                                            | •     | •         | •        |             |           |                | •       | • |
| hdadm        | Error       | 3864     | Failed to initialize the mirror connect.                                                                                                               | Mirror connection initialization failed       | Make sure there is no error in the network adapter and the network is correctly connected.          | •     | •         | •        |             |           |                | •       | • |
| hdadm        | Error       | 3865     | Failed to initialize the hybrid disk %1.                                                                                                               | Hybrid disk initialization failed             | Check the partition exists and the disk is recognized by the operating system.                      | •     | •         | •        |             |           |                | •       | • |
| hdadm        | Error       | 3866     | Failed to initialize the hybrid disk %1. The cluster partition and the data partition must be different partitions.                                    | Hybrid disk initialization failed             | Check the cluster configuration data.                                                               | •     | •         | •        |             |           |                |         | • |
| hdadm        | Error       | 3867     | Failed to initialize the hybrid disk %1. The area in the cluster partition has been used by another hybrid disk.                                       | Hybrid disk initialization failed             | Check the cluster configuration data.                                                               | •     | •         | •        |             |           |                |         | • |
| hdadm        | Error       | 3868     | Failed to initialize the hybrid disk %1. The partition specified for the cluster partition has been used as the data partition of another hybrid disk. | Hybrid disk initialization failed             | Check the cluster configuration data.                                                               | •     | •         | •        |             |           |                |         | • |

Messages reported by event log and alert

| Module Type | Event Type  | Event ID | Messages                                                                                                                               | Description                                                                                              | Solution                                                                                            | Alert | Event log | User log | Mail report | SNMP Trap | Report setting |         |   |
|-------------|-------------|----------|----------------------------------------------------------------------------------------------------------------------------------------|----------------------------------------------------------------------------------------------------------|-----------------------------------------------------------------------------------------------------|-------|-----------|----------|-------------|-----------|----------------|---------|---|
|             |             |          |                                                                                                                                        |                                                                                                          |                                                                                                     |       |           |          |             |           | Alive          | Manager |   |
| hdadm       | Error       | 3869     | Failed to initialize the hybrid disk %1. The partition specified for the data partition has been used by another hybrid disk.          | Hybrid disk initialization failed                                                                        | Check the cluster configuration data.                                                               | •     | •         | •        |             |           |                | •       |   |
| hdadm       | Error       | 3870     | Connecting hybrid disk %1 has failed.                                                                                                  | Connecting hybrid disk failed                                                                            | Check the partition exists and the disk is recognized by the operating system.                      |       | •         |          |             |           |                | •       | • |
| hdadm       | Error       | 3871     | Disconnecting hybrid disk %1 has failed.                                                                                               | Disconnecting hybrid disk failed                                                                         | Check if the hybrid disk is being used.                                                             |       | •         |          |             |           |                |         | • |
| hdadm       | Information | 3872     | Detected a disk resource that has not been identified. Disk reidentification will be executed.                                         | Disk reidentification starts                                                                             | -                                                                                                   | •     | •         | •        |             |           |                |         |   |
| hdadm       | Information | 3873     | Reidentification of the disk has finished.                                                                                             | Disk reidentification finished.                                                                          | -                                                                                                   | •     | •         | •        |             |           |                |         |   |
| hdadm       | Error       | 3874     | A fatal error has occurred during control hybrid disk %1. Shutdown the server.                                                         | Fatal error has occurred                                                                                 | Make sure there is no error in the disk and network adapter and the network is correctly connected. | •     | •         | •        |             |           |                | •       | • |
| hdadm       | Warning     | 3875     | The mirror disk connect of hybrid disk %1 has been changed. (Priority %2 -> %3)                                                        | The mirror disk connect has been switched due to disconnection of the active mirror disk connect.        | Make sure there is no error in the network adapter and the network is correctly connected.          | •     | •         | •        |             |           |                |         |   |
| hdadm       | Error       | 3876     | Disconnecting hybrid disk %1 has failed while it is being copied. The server is shut down to protect data.                             | Failed sending server closing due to process access<br>Execution of emergency shutdown by process access | The hybrid disk may be in use. Check the mirror disk.                                               | •     | •         | •        |             |           |                | •       | • |
| hdadm       | Warning     | 3880     | The mirror disk connect of hybrid disk %1 has been disconnected.                                                                       | An error occurred in the mirror disk connect.                                                            | Make sure there is no error in the network adapter and the network is correctly connected.          | •     | •         | •        |             |           |                |         |   |
| hdadm       | Warning     | 3881     | The Auto mirror recovery check box is not selected. It is necessary to recover the mirror manually, in order to resume mirroring (%1). | It is necessary to recover the mirror manually, in order to resume mirroring.                            | Recover a mirror from the command or Mirror Disk Helper.                                            | •     | •         | •        | •           |           |                |         |   |
| hdtw        | Warning     | 4001     | Monitor %1 was delayed. (timeout=%2 response time=%3 rate=%4)                                                                          | Monitoring is delayed                                                                                    | -                                                                                                   | •     | •         | •        |             |           |                |         | • |
| hdtw        | Error       | 4002     | Cannot access the disk (%1).                                                                                                           | Disconnection is detected.                                                                               | Make sure there is no error in the disk and the shared disk is correctly connected.                 |       | •         |          |             |           |                | •       | • |
| hdtw        | Information | 4003     | Recovered the status where access to the disk (%1) is possible.                                                                        | Recovery from disconnection has been done.                                                               | -                                                                                                   |       | •         |          |             |           |                |         |   |

| Module Type | Event Type  | Event ID | Messages                                                                                                                 | Description                                     | Solution                                                                                                            | Alert | Event log | User log | Mail report | SNMP Trap | Report setting | Manager |
|-------------|-------------|----------|--------------------------------------------------------------------------------------------------------------------------|-------------------------------------------------|---------------------------------------------------------------------------------------------------------------------|-------|-----------|----------|-------------|-----------|----------------|---------|
|             |             |          |                                                                                                                          |                                                 |                                                                                                                     |       |           |          |             |           | Alive          | Alive   |
| mail        | Error       | 4101     | mail failed(%1).(SMTP server: %2)                                                                                        | Mail failed                                     | Make sure there is no error in the SMTP server and no problem communicating with the SMTP server.                   | •     | •         | •        |             |           |                | •       |
| mail        | Information | 4102     | mail succeed.(SMTP server: %1)                                                                                           | Mail succeeded                                  | -                                                                                                                   |       | •         | •        |             |           |                |         |
| lamp        | Information | 4151     | Notice by the network warning light succeeded.                                                                           | Network warning light succeeded                 | -                                                                                                                   | •     | •         | •        |             |           |                |         |
| lamp        | Error       | 4152     | Error in network warning light notice command.(%1)                                                                       | Network warning light failed                    | Take appropriate action by following the error code.                                                                | •     | •         | •        |             |           |                | •       |
| lamp        | Error       | 4153     | Failed to execute warning light command.(%1)                                                                             | Network warning light failed                    | The system may not be able to operate properly.                                                                     | •     | •         | •        |             |           |                | •       |
| cifs        | Information | 4201     | Created new shared configuration file.                                                                                   | Created new shared configuration file.          | -                                                                                                                   | •     | •         | •        |             |           |                |         |
| cifs        | Warning     | 4202     | Failed to read in shared configuration file. File may be corrupted.                                                      | Reading shared configuration file failed.       | Check if the shared configuration file is corrupted.                                                                | •     | •         | •        |             |           |                |         |
| cifs        | Information | 4203     | Recovered shared configuration file from backup file.                                                                    | Shared configuration file is restored.          | -                                                                                                                   | •     | •         | •        |             |           |                |         |
| cifs        | Warning     | 4204     | Recreated shared configuration file since it cannot be found.                                                            | Shared configuration file is created again.     | This is a normal action at first activation. In other cases, check if the shared configuration file is not deleted. | •     | •         | •        |             |           |                |         |
| cifs        | Warning     | 4205     | There are differences between share settings stored in shared configuration file and the current configuration settings. | Sharing target folder is lost.                  | Check if the shared folder is not deleted while CIFS resource is deactivated.                                       | •     | •         | •        |             |           |                |         |
| cifs        | Information | 4206     | Failed to get shared folder account information                                                                          | Failed to get shared folder account information | Check if a deleted group or user is set in <b>Permissions</b> for the shared folder.                                | •     | •         | •        |             |           |                |         |
| apisv       | Information | 4301     | There was a request to stop cluster from the %1(IP=%2).                                                                  | Cluster stop                                    | -                                                                                                                   | •     |           | •        |             |           |                |         |
| apisv       | Information | 4302     | There was a request to shutdown cluster from the %1(IP=%2).                                                              | Cluster shutdown                                | -                                                                                                                   | •     |           | •        |             |           |                |         |
| apisv       | Information | 4303     | There was a request to reboot cluster from the %1(IP=%2).                                                                | Cluster restart                                 | -                                                                                                                   | •     |           | •        |             |           |                |         |
| apisv       | Information | 4304     | There was a request to suspend cluster from the %1(IP=%2).                                                               | Cluster suspend                                 | -                                                                                                                   | •     |           | •        |             |           |                |         |
| apisv       | Information | 4310     | There was a request to stop server from the %1(IP=%2).                                                                   | Cluster service stop                            | -                                                                                                                   | •     |           | •        |             |           |                |         |
| apisv       | Information | 4311     | There was a request to shutdown server from the %1(IP=%2).                                                               | Shutdown                                        | -                                                                                                                   | •     |           | •        |             |           |                |         |
| apisv       | Information | 4312     | There was a request to reboot server from the %1(IP=%2).                                                                 | Restart                                         | -                                                                                                                   | •     |           | •        |             |           |                |         |



Messages reported by event log and alert

| Module Type | Event Type  | Event ID | Messages                                                                                                       | Description          | Solution | Alert | Event log | User log | Mail report | SNMP Trap | Report setting |         |  |
|-------------|-------------|----------|----------------------------------------------------------------------------------------------------------------|----------------------|----------|-------|-----------|----------|-------------|-----------|----------------|---------|--|
|             |             |          |                                                                                                                |                      |          |       |           |          |             |           | Alive          | Manager |  |
| apisv       | Information | 4330     | There was a request to start group(%1) from the %2(IP=%3).                                                     | Group start          | -        | •     |           | •        |             |           |                |         |  |
| apisv       | Information | 4331     | There was a request to start all groups from the %1(IP=%2).                                                    | All group start      | -        | •     |           | •        |             |           |                |         |  |
| apisv       | Information | 4332     | There was a request to stop group(%1) from the %2(IP=%3).                                                      | Group stop           |          | •     |           | •        |             |           |                |         |  |
| apisv       | Information | 4333     | There was a request to stop all groups from the %1(IP=%2).                                                     | All group stop       | -        | •     |           | •        |             |           |                |         |  |
| apisv       | Information | 4334     | There was a request to restart group(%1) from the %2(IP=%3).                                                   | Group restart        | -        | •     |           | •        |             |           |                |         |  |
| apisv       | Information | 4335     | There was a request to restart all groups from the %1(IP=%2).                                                  | All group restart    | -        | •     |           | •        |             |           |                |         |  |
| apisv       | Information | 4336     | There was a request to move group(%1) from the %2(IP=%3).                                                      | Group move           | -        | •     |           | •        |             |           |                |         |  |
| apisv       | Information | 4337     | There was a request to move all groups from the %1(IP=%2).                                                     | All group move       | -        | •     |           | •        |             |           |                |         |  |
| apisv       | Information | 4338     | There was a request to failover group(%1) from the %2(IP=%3).                                                  | Group failover       | -        | •     |           | •        |             |           |                |         |  |
| apisv       | Information | 4339     | There was a request to failover all groups from the %1(IP=%2).                                                 | All group failover   | -        | •     |           | •        |             |           |                |         |  |
| apisv       | Information | 4340     | There was a request to migrate group(%1) from the %2(IP=%3).                                                   | Group migration      | -        | •     |           | •        |             |           |                |         |  |
| apisv       | Information | 4341     | There was a request to migrate all groups from the %1(IP=%2).                                                  | All group migration  | -        | •     |           | •        |             |           |                |         |  |
| apisv       | Information | 4342     | There was a request to failover all groups from the %1(IP=%2).                                                 | All group failover   | -        | •     |           | •        |             |           |                |         |  |
| apisv       | Information | 4343     | There was a request to cancel waiting for the dependence destination group of group %1 was issued from the %2. | Cancel waiting       | -        | •     |           | •        |             |           |                |         |  |
| apisv       | Information | 4350     | There was a request to start resource(%1) from the %2(IP=%3).                                                  | Resource start       | -        | •     |           | •        |             |           |                |         |  |
| apisv       | Information | 4351     | There was a request to start all resources from the %1(IP=%2).                                                 | All resource start   | -        | •     |           | •        |             |           |                |         |  |
| apisv       | Information | 4352     | There was a request to stop resource(%1) from the %2(IP=%3).                                                   | Resource stop        | -        | •     |           | •        |             |           |                |         |  |
| apisv       | Information | 4353     | There was a request to stop all resources from the %1(IP=%2).                                                  | All resource stop    | -        | •     |           | •        |             |           |                |         |  |
| apisv       | Information | 4354     | There was a request to restart resource(%1) from the %2(IP=%3).                                                | Resource restart     | -        | •     |           | •        |             |           |                |         |  |
| apisv       | Information | 4355     | There was a request to restart all resources from the %1(IP=%2).                                               | All resource restart | -        | •     |           | •        |             |           |                |         |  |

| Module Type | Event Type  | Event ID | Messages                                                                                  | Description                  | Solution                  | Alert | Event log | User log | Mail report | SNMP Trap | Report setting | Manager |
|-------------|-------------|----------|-------------------------------------------------------------------------------------------|------------------------------|---------------------------|-------|-----------|----------|-------------|-----------|----------------|---------|
|             |             |          |                                                                                           |                              |                           |       |           |          |             |           | Alive          | Alive   |
| apisv       | Information | 4360     | There was a request to suspend monitor resources from the %1(IP=%2).                      | Monitor temporary stop       | -                         | •     |           | •        |             |           |                |         |
| apisv       | Information | 4361     | There was a request to resume monitor resources from the %1(IP=%2).                       | Monitor restart              | -                         | •     |           | •        |             |           |                |         |
| apisv       | Information | 4362     | There was a request to enable Dummy Failure of monitor resource(%1) from the %2(IP=%3).   | Dummy Failure enabled        | -                         | •     |           | •        |             |           |                |         |
| apisv       | Information | 4363     | There was a request to disable Dummy Failure of monitor resource(%1) from the %2(IP=%3).  | Dummy Failure disabled       | -                         | •     |           | •        |             |           |                |         |
| apisv       | Information | 4364     | There was a request to disable Dummy Failure of all monitor resources from the %1(IP=%2). | All Dummy Failure disabled   | -                         | •     |           | •        |             |           |                |         |
| apisv       | Information | 4370     | There was a request to set CPU frequency from the %1(IP=%2).                              | CPU clock control            | -                         | •     |           | •        |             |           |                |         |
| apisv       | Error       | 4401     | A request to stop cluster was failed(%1).                                                 | Cluster stop failure         | Check the cluster status. | •     |           | •        |             |           |                |         |
| apisv       | Error       | 4402     | A request to shutdown cluster was failed(%1).                                             | Cluster shutdown failure     | Check the cluster status. | •     |           | •        |             |           |                |         |
| apisv       | Error       | 4403     | A request to reboot cluster was failed(%1).                                               | Cluster restart failure      | Check the cluster status. | •     |           | •        |             |           |                |         |
| apisv       | Error       | 4404     | A request to suspend cluster was failed(%1).                                              | Cluster suspend failure      | Check the cluster status. | •     |           | •        |             |           |                |         |
| apisv       | Error       | 4410     | A request to stop server was failed(%1).                                                  | Cluster service stop failure | Check the cluster status. | •     |           | •        |             |           |                |         |
| apisv       | Error       | 4411     | A request to shutdown server was failed(%1).                                              | Server shutdown failure      | Check the server status.  | •     |           | •        |             |           |                |         |
| apisv       | Error       | 4412     | A request to reboot server was failed(%1).                                                | Server restart failure       | Check the server status.  | •     |           | •        |             |           |                |         |
| apisv       | Error       | 4430     | A request to start group(%1) was failed(%2).                                              | Group start failure          | Check the group status.   | •     |           | •        |             |           |                |         |
| apisv       | Error       | 4431     | A request to start all groups was failed(%1).                                             | All group start failure      | Check the group status.   | •     |           | •        |             |           |                |         |
| apisv       | Error       | 4432     | A request to stop group(%1) was failed(%2).                                               | Group stop failure           | Check the group status.   | •     |           | •        |             |           |                |         |
| apisv       | Error       | 4433     | A request to stop all groups was failed(%1).                                              | All group stop failure       | Check the group status.   | •     |           | •        |             |           |                |         |
| apisv       | Error       | 4434     | A request to restart group(%1) was failed(%2).                                            | Group restart failure        | Check the group status.   | •     |           | •        |             |           |                |         |
| apisv       | Error       | 4435     | A request to restart all groups was failed(%1).                                           | All group restart failure    | Check the group status.   | •     |           | •        |             |           |                |         |
| apisv       | Error       | 4436     | A request to move group(%1) was failed(%2).                                               | Group move failure           | Check the group status.   | •     |           | •        |             |           |                |         |
| apisv       | Error       | 4437     | A request to move all groups was failed(%1).                                              | All group move failure       | Check the group status.   | •     |           | •        |             |           |                |         |
| apisv       | Error       | 4438     | A request to failover group(%1) was failed(%2).                                           | Group failover failure       | Check the group status.   | •     |           | •        |             |           |                |         |
| apisv       | Error       | 4439     | A request to failover all groups was failed(%1).                                          | All group failover failure   | Check the group status.   | •     |           | •        |             |           |                |         |

Messages reported by event log and alert

| Module Type | Event Type | Event ID | Messages                                                                                                                                    | Description                                    | Solution                                                                                                  | Alert | Event log | User log | Mail report | SNMP Trap | Report setting |         |  |
|-------------|------------|----------|---------------------------------------------------------------------------------------------------------------------------------------------|------------------------------------------------|-----------------------------------------------------------------------------------------------------------|-------|-----------|----------|-------------|-----------|----------------|---------|--|
|             |            |          |                                                                                                                                             |                                                |                                                                                                           |       |           |          |             |           | Alive          | Manager |  |
| apisv       | Error      | 4440     | A request to migrate group(%1) was failed(%2).                                                                                              | Group migration failure                        | Check the group status.                                                                                   | •     |           | •        |             |           |                |         |  |
| apisv       | Error      | 4441     | A request to migrate all groups was failed(%1).                                                                                             | All group migration failure                    | Check the group status.                                                                                   | •     |           | •        |             |           |                |         |  |
| apisv       | Error      | 4442     | A request to failover all groups was failed(%1).                                                                                            | All group failover failure                     | Check the group status.                                                                                   | •     |           | •        |             |           |                |         |  |
| apisv       | Error      | 4443     | A request to cancel waiting for the dependency destination group of group %s has failed(%1).                                                | Cancel waiting failure                         | Check the group status.                                                                                   | •     |           | •        |             |           |                |         |  |
| apisv       | Error      | 4450     | A request to start resource(%1) was failed(%2).                                                                                             | Resource start failure                         | Check the resource status.                                                                                | •     |           | •        |             |           |                |         |  |
| apisv       | Error      | 4451     | A request to start all resources was failed(%1).                                                                                            | All resource start failure                     | Check the resource status.                                                                                | •     |           | •        |             |           |                |         |  |
| apisv       | Error      | 4452     | A request to stop resource(%1) was failed(%2).                                                                                              | Resource stop failure                          | Check the resource status.                                                                                | •     |           | •        |             |           |                |         |  |
| apisv       | Error      | 4453     | A request to stop all resources was failed(%1).                                                                                             | All resource stop failure                      | Check the resource status.                                                                                | •     |           | •        |             |           |                |         |  |
| apisv       | Error      | 4454     | A request to restart resource(%1) was failed(%2).                                                                                           | Resource restart failure                       | Check the resource status.                                                                                | •     |           | •        |             |           |                |         |  |
| apisv       | Error      | 4455     | A request to restart all resources was failed(%1).                                                                                          | All resource restart failure                   | Check the resource status.                                                                                | •     |           | •        |             |           |                |         |  |
| apisv       | Error      | 4460     | A request to suspend monitor resource was failed(%1).                                                                                       | Monitor temporary stop failure                 | Check the monitor resource status.                                                                        | •     |           | •        |             |           |                |         |  |
| apisv       | Error      | 4461     | A request to resume monitor resource was failed(%1).                                                                                        | Monitor restart failure                        | Check the monitor resource status.                                                                        | •     |           | •        |             |           |                |         |  |
| apisv       | Error      | 4462     | A request to enable Dummy Failure of monitor resource(%1) was failed(%2).                                                                   | Dummy Failure enabled                          | Check the monitor resource status.                                                                        | •     |           | •        |             |           |                |         |  |
| apisv       | Error      | 4463     | A request to disable Dummy Failure of monitor resource(%1) was failed(%2).                                                                  | Dummy Failure disabled                         | Check the monitor resource status.                                                                        | •     |           | •        |             |           |                |         |  |
| apisv       | Error      | 4464     | A request to disable Dummy Failure of all monitor resource was failed(%1).                                                                  | All Dummy Failure disabled                     | Check the monitor resource status.                                                                        | •     |           | •        |             |           |                |         |  |
| apisv       | Error      | 4470     | A request to set CPU frequency was failed(%1).                                                                                              | CPU clock control failure                      | Check if the server handles CPU clock control.                                                            | •     |           | •        |             |           |                |         |  |
| apisv       | Error      | 4480     | Initializing internal communication (%1) failed (port=%2).                                                                                  | Initializing internal communication failed.    | Check if an application other than EXPRESSCLUSTER uses the port.                                          | •     |           | •        |             |           |                |         |  |
| diskperf    | Warning    | 4801     | An internal error occurred in clpdiskperf.dll There is a possibility that certain Cluster Disk Resource Performance Data can't be collected | An internal error occurred in clpdiskperf.dll. | There may be insufficient memory or OS resources. Check whether there are sufficient resources available. | •     | •         | •        |             |           |                |         |  |

| Module Type | Event Type  | Event ID | Messages                                                                                                                        | Description                                                                          | Solution                                                                                                                                                                                                                                                                        | Alert | Event log | User log | Mail report | SNMP Trap | Report setting | Manager |
|-------------|-------------|----------|---------------------------------------------------------------------------------------------------------------------------------|--------------------------------------------------------------------------------------|---------------------------------------------------------------------------------------------------------------------------------------------------------------------------------------------------------------------------------------------------------------------------------|-------|-----------|----------|-------------|-----------|----------------|---------|
|             |             |          |                                                                                                                                 |                                                                                      |                                                                                                                                                                                                                                                                                 |       |           |          |             |           | Alive          | Alive   |
| diskperf    | Information | 4802     | clpdiskperf.dll internal problem has gone.                                                                                      | The internal error in clpdiskperf.dll has been resolved.                             | -                                                                                                                                                                                                                                                                               | •     | •         | •        |             |           |                |         |
| diskperf    | Warning     | 4803     | An error occurred by writing in Cluster Disk Resource Performance Data log. Please confirm the state of the disk.               | An error occurred when writing the Cluster Disk Resource Performance Data log.       | Check whether there is sufficient free disk space.                                                                                                                                                                                                                              | •     | •         | •        |             |           |                |         |
| diskperf    | Information | 4804     | Write error of Cluster Disk Resource Performance Data log was recovered.                                                        | The write error in the Cluster Disk Resource Performance Data log has been resolved. | -                                                                                                                                                                                                                                                                               | •     | •         | •        |             |           |                |         |
| diskperf    | Error       | 4805     | An internal error occurred in clpdiskperf.dll Cluster Disk Resource Performance Data can't be collected until a server restart. | An internal error occurred in clpdiskperf.dll                                        | Reboot the server.                                                                                                                                                                                                                                                              |       | •         | •        |             |           |                |         |
| diskperf    | Error       | 4806     | Cluster Disk Resource Performance Data can't be collected because a performance monitor is too numerous.                        | The number of processes that load clpdiskperf.dll exceeded 32.                       | Refer to the following topic in the <i>Getting Started Guide</i> : Chapter 5, "Notes and Restrictions" → "After starting operating EXPRESSCLUSTER" → "Event log output relating to linkage between mirror statistical information collection function and OS standard function" |       |           |          |             |           |                |         |
| bmchb       | Error       | 4951     | Failed to initialize BMC.                                                                                                       |                                                                                      |                                                                                                                                                                                                                                                                                 |       |           |          |             |           |                |         |
| bmchb       | Warning     | 4952     | Heartbeat from HB resource %1 of server %2 was delayed.                                                                         |                                                                                      |                                                                                                                                                                                                                                                                                 |       |           |          |             |           |                |         |
| userw       | Warning     | 5001     | Monitor %1 was delayed. (timeout=%2 response time=%3 rate=%4)                                                                   | Monitor delayed                                                                      | —                                                                                                                                                                                                                                                                               | •     | •         | •        |             |           |                | •       |
| db2         | Warning     | 10001    | %1                                                                                                                              | Error message for each monitored application.                                        | Take appropriate action for the application failure by following the error message.                                                                                                                                                                                             | •     | -         | -        | -           | -         | -              | -       |
| ftp         |             |          |                                                                                                                                 |                                                                                      |                                                                                                                                                                                                                                                                                 |       |           |          |             |           |                |         |
| http        |             |          |                                                                                                                                 |                                                                                      |                                                                                                                                                                                                                                                                                 |       |           |          |             |           |                |         |
| imap4       |             |          |                                                                                                                                 |                                                                                      |                                                                                                                                                                                                                                                                                 |       |           |          |             |           |                |         |
| odbc        |             |          |                                                                                                                                 |                                                                                      |                                                                                                                                                                                                                                                                                 |       |           |          |             |           |                |         |
| oracle      |             |          |                                                                                                                                 |                                                                                      |                                                                                                                                                                                                                                                                                 |       |           |          |             |           |                |         |
| oracleas    |             |          |                                                                                                                                 |                                                                                      |                                                                                                                                                                                                                                                                                 |       |           |          |             |           |                |         |
| oss         |             |          |                                                                                                                                 |                                                                                      |                                                                                                                                                                                                                                                                                 |       |           |          |             |           |                |         |
| otx         |             |          |                                                                                                                                 |                                                                                      |                                                                                                                                                                                                                                                                                 |       |           |          |             |           |                |         |
| pop3        |             |          |                                                                                                                                 |                                                                                      |                                                                                                                                                                                                                                                                                 |       |           |          |             |           |                |         |
| psql        |             |          |                                                                                                                                 |                                                                                      |                                                                                                                                                                                                                                                                                 |       |           |          |             |           |                |         |
| smtp        |             |          |                                                                                                                                 |                                                                                      |                                                                                                                                                                                                                                                                                 |       |           |          |             |           |                |         |
| sqlserver   |             |          |                                                                                                                                 |                                                                                      |                                                                                                                                                                                                                                                                                 |       |           |          |             |           |                |         |
| tux         |             |          |                                                                                                                                 |                                                                                      |                                                                                                                                                                                                                                                                                 |       |           |          |             |           |                |         |
| was         |             |          |                                                                                                                                 |                                                                                      |                                                                                                                                                                                                                                                                                 |       |           |          |             |           |                |         |
| wls         |             |          |                                                                                                                                 |                                                                                      |                                                                                                                                                                                                                                                                                 |       |           |          |             |           |                |         |
| db2w        | Warning     | 10002    | The API Error of                                                                                                                | API error of Windows has                                                             | Take appropriate action for                                                                                                                                                                                                                                                     | •     |           |          |             |           |                |         |

Messages reported by event log and alert

| Module Type | Event Type | Event ID | Messages                                       | Description                                                  | Solution                                                                         | Alert | Event log | User log | Mail report | SNMP Trap | Report  |         |   |
|-------------|------------|----------|------------------------------------------------|--------------------------------------------------------------|----------------------------------------------------------------------------------|-------|-----------|----------|-------------|-----------|---------|---------|---|
|             |            |          |                                                |                                                              |                                                                                  |       |           |          |             |           | setting | Manager |   |
| ftpw        |            |          | Windows occurred.%1                            | occurred. %1 is API error code.                              | the OS failure by following the error code.                                      |       |           |          |             |           |         |         |   |
| httpw       |            |          |                                                |                                                              |                                                                                  |       |           |          |             |           |         |         |   |
| imap4w      |            |          |                                                |                                                              |                                                                                  |       |           |          |             |           |         |         |   |
| odbcw       |            |          |                                                |                                                              |                                                                                  |       |           |          |             |           |         |         |   |
| oraclew     |            |          |                                                |                                                              |                                                                                  |       |           |          |             |           |         |         |   |
| oracleasw   |            |          |                                                |                                                              |                                                                                  |       |           |          |             |           |         |         |   |
| ossw        |            |          |                                                |                                                              |                                                                                  |       |           |          |             |           |         |         |   |
| otxw        |            |          |                                                |                                                              |                                                                                  |       |           |          |             |           |         |         |   |
| pop3w       |            |          |                                                |                                                              |                                                                                  |       |           |          |             |           |         |         |   |
| psqlw       |            |          |                                                |                                                              |                                                                                  |       |           |          |             |           |         |         |   |
| smtpw       |            |          |                                                |                                                              |                                                                                  |       |           |          |             |           |         |         |   |
| sqlserverw  |            |          |                                                |                                                              |                                                                                  |       |           |          |             |           |         |         |   |
| tuxw        |            |          |                                                |                                                              |                                                                                  |       |           |          |             |           |         |         |   |
| wasw        |            |          |                                                |                                                              |                                                                                  |       |           |          |             |           |         |         |   |
| wlsw        |            |          |                                                |                                                              |                                                                                  |       |           |          |             |           |         |         |   |
| db2         |            |          |                                                |                                                              |                                                                                  |       |           |          |             |           |         |         |   |
| ftp         |            |          |                                                |                                                              |                                                                                  |       |           |          |             |           |         |         |   |
| http        |            |          |                                                |                                                              |                                                                                  |       |           |          |             |           |         |         |   |
| imap4       |            |          |                                                |                                                              |                                                                                  |       |           |          |             |           |         |         |   |
| odbc        |            |          |                                                |                                                              |                                                                                  |       |           |          |             |           |         |         |   |
| oracle      |            |          |                                                |                                                              |                                                                                  |       |           |          |             |           |         |         |   |
| oracleas    |            |          |                                                |                                                              |                                                                                  |       |           |          |             |           |         |         |   |
| oss         |            |          |                                                |                                                              |                                                                                  |       |           |          |             |           |         |         |   |
| otx         |            |          |                                                |                                                              |                                                                                  |       |           |          |             |           |         |         |   |
| pop3        |            |          |                                                |                                                              |                                                                                  |       |           |          |             |           |         |         |   |
| psql        |            |          |                                                |                                                              |                                                                                  |       |           |          |             |           |         |         |   |
| smtp        |            |          |                                                |                                                              |                                                                                  |       |           |          |             |           |         |         |   |
| sqlserver   |            |          |                                                |                                                              |                                                                                  |       |           |          |             |           |         |         |   |
| tux         |            |          |                                                |                                                              |                                                                                  |       |           |          |             |           |         |         |   |
| was         |            |          |                                                |                                                              |                                                                                  |       |           |          |             |           |         |         |   |
| wls         |            |          |                                                |                                                              |                                                                                  |       |           |          |             |           |         |         |   |
| tuxw        | Warning    | 10004    | The API Error of Application occurred.%1       | API error of application has occurred. %1 is API error code. | Take appropriate action for the application failure by following the error code. | •     |           |          |             |           |         |         |   |
| mrw         | Warning    | 4901     | Monitor %1 is in the warning status. (%2 : %3) | Monitor warn                                                 | Check the cause of Warning.                                                      | •     | •         | •        |             |           |         |         | • |
| mrw         | Warning    | 4902     | Configuration of %1 is invalid. (%2 : %3)      | invalid monitor resource                                     | Check the cluster configuration data.                                            | •     | •         | •        |             |           |         |         | • |
| mrw         | Error      | 4903     | Failed to start monitor %1.                    | monitor starting failed                                      | The system may not be able to operate properly.                                  | •     | •         | •        | •           | •         |         |         | • |
| mrw         | Error      | 4904     | Failed to stop monitor %1.                     | monitor stopping failed                                      | The system may not be able to operate properly.                                  | •     | •         | •        |             |           |         |         | • |
| mrw         | Error      | 4905     | Monitor %1 detected an error. (%2 : %3)        | monitor failed                                               | Check the cause for monitor error.                                               | •     | •         | •        | •           | •         |         |         | • |

| Module Type | Event Type  | Event ID | Messages                                                               | Description                     | Solution                                        | Alert | Event log | User log | Mail report | SNMP Trap | Report setting |         |   |
|-------------|-------------|----------|------------------------------------------------------------------------|---------------------------------|-------------------------------------------------|-------|-----------|----------|-------------|-----------|----------------|---------|---|
|             |             |          |                                                                        |                                 |                                                 |       |           |          |             |           | Alive          | Manager |   |
| mrw         | Information | 4906     | Monitor resource has not been registered.                              | unregistered monitor resource   | -                                               | •     | •         | •        |             |           |                |         |   |
| mrw         | Information | 4907     | %1 was stopped for failure in monitor %2.                              | relation stop                   | -                                               | •     | •         | •        |             |           |                |         |   |
| mrw         | Information | 4908     | %1 was restarted for failure in monitor %2.                            | relation restart                | -                                               | •     | •         | •        |             |           |                |         |   |
| mrw         | Information | 4909     | %1 was failed over for failure in monitor %2.                          | relation group failover         | -                                               | •     | •         | •        |             |           |                |         |   |
| mrw         | Information | 4910     | There was a request to stop cluster for failure in monitor %1.         | cluster stop                    | -                                               | •     | •         | •        |             |           |                |         |   |
| mrw         | Information | 4911     | There was a request to shut down the system for failure in monitor %1. | system shutdown                 | -                                               | •     | •         | •        |             |           |                |         |   |
| mrw         | Information | 4912     | There was a request to restart the system for failure in monitor %1.   | system reboot                   | -                                               | •     | •         | •        |             |           |                |         |   |
| mrw         | Information | 4913     | Failed to stop %1 due to error detection of %2.                        | relation stop failure           | Check the status of resources.                  | •     | •         | •        |             |           |                |         | • |
| mrw         | Error       | 4914     | Failed to restart %1 due to error detection of %2.                     | relation restart failure        | Check the status of resources.                  | •     | •         | •        |             |           |                |         | • |
| mrw         | Error       | 4915     | Failed to fail over %1 due to error detection of %2.                   | relation group failover failure | Check the status of resources.                  | •     | •         | •        |             |           |                |         | • |
| mrw         | Error       | 4916     | Failed to stop the cluster due to error detection of %1.               | cluster stop failure            | The system may not be able to operate properly. | •     | •         | •        |             |           |                |         | • |
| mrw         | Error       | 4917     | Failed to shut down the system due to error detection of %1.           | os shutdown failure             | The system may not be able to operate properly. | •     | •         | •        |             |           |                |         | • |
| mrw         | Error       | 4918     | Failed to restart the system due to error detection of %1.             | os reboot failure               | The system may not be able to operate properly. | •     | •         | •        |             |           |                |         | • |

Messages reported by event log and alert

| Module Type | Event Type  | Event ID | Messages                                                                                | Description                                                          | Solution                                                                                                                                                                                                                  | Alert | Event log | User log | Mail report | SNMP Trap | Report setting |         |
|-------------|-------------|----------|-----------------------------------------------------------------------------------------|----------------------------------------------------------------------|---------------------------------------------------------------------------------------------------------------------------------------------------------------------------------------------------------------------------|-------|-----------|----------|-------------|-----------|----------------|---------|
|             |             |          |                                                                                         |                                                                      |                                                                                                                                                                                                                           |       |           |          |             |           | Alive          | Manager |
| mrw         | Error       | 4919     | The group of monitor %1 is unknown.                                                     | unknown group                                                        | Check the cluster configuration data.                                                                                                                                                                                     | •     | •         | •        |             |           |                | •       |
| mrw         | Warning     | 4920     | No action is taken because %1 is not online.                                            | not perform failure action                                           | -                                                                                                                                                                                                                         | •     | •         | •        |             |           |                | •       |
| mrw         | Information | 4921     | Status of monitor %1 was returned to normal.                                            | status changed into normal                                           | -                                                                                                                                                                                                                         | •     | •         | •        |             |           |                |         |
| mrw         | Information | 4922     | Status of monitor %1 was changed into unknown.                                          | status changed into unknown                                          | The system may not be able to operate properly.                                                                                                                                                                           | •     | •         | •        |             |           |                |         |
| mrw         | Error       | 4923     | Initialization error has occurred (%1 : %2)                                             | process initialize error                                             | The system may not be able to operate properly.                                                                                                                                                                           | •     | •         | •        |             |           |                | •       |
| mrw         | Information | 4924     | Causing intentional stop error was required because an error is detected by %1.         | intentional panic                                                    | -                                                                                                                                                                                                                         | •     | •         | •        |             |           |                |         |
| mrw         | Error       | 4925     | Causing intentional stop error has failed because an error is detected by %1.           | intentional panic failure                                            | The system may not be able to operate properly.                                                                                                                                                                           | •     | •         | •        |             |           |                | •       |
| mrw         | Warning     | 4926     | Recovery will not be executed since server is suspending.                               | not recovery(server suspending)                                      | Monitor resource is not recovered if the server is suspended (Network Partition Unsolved). Check the cause for being suspended (Network Partition Unsolved) and recover network partition resources to the normal status. | •     | •         | •        |             |           |                | •       |
| mrw         | Warning     | 4927     | Shutdown count reached the maximum number (%1). Final action of monitor %2 was ignored. | reached OS shutdown limit                                            | -                                                                                                                                                                                                                         | •     | •         | •        | •           | •         |                | •       |
| mrw         | Information | 4928     | Script before action(%1) upon failure in %2 monitor resource started.                   | Script before final action upon monitor resource failure started.    | -                                                                                                                                                                                                                         | •     | •         | •        |             |           |                |         |
| mrw         | Information | 4929     | Script before action(%1) upon failure in %2 monitor resource completed.                 | Script before final action upon monitor resource failure completed.  | -                                                                                                                                                                                                                         | •     | •         | •        |             |           |                |         |
| mrw         | Information | 4930     | Script before action(%1) upon failure in %2 monitor resource failed.                    | Script before final action upon monitor resource failure has failed. | -                                                                                                                                                                                                                         | •     | •         | •        |             |           |                |         |

| Module Type | Event Type  | Event ID | Messages                                                                                                           | Description                                                                                                                                              | Solution                                                                                  | Alert | Event log | User log | Mail report | SNMP Trap | Report setting | Manager |
|-------------|-------------|----------|--------------------------------------------------------------------------------------------------------------------|----------------------------------------------------------------------------------------------------------------------------------------------------------|-------------------------------------------------------------------------------------------|-------|-----------|----------|-------------|-----------|----------------|---------|
|             |             |          |                                                                                                                    |                                                                                                                                                          |                                                                                           |       |           |          |             |           | Alive          |         |
| mrw         | Information | 4931     | Recovery script has executed because an error was detected in monitoring %1.                                       | Recovery script upon monitor resource failure executed                                                                                                   |                                                                                           | •     | •         | •        |             |           |                |         |
| mrw         | Error       | 4932     | Attempted to execute recovery script due to the error detected in monitoring %1, but failed.                       | failed to execute recovery script                                                                                                                        | Check the cause of the recovery script failure and take measures.                         | •     | •         | •        |             |           |                |         |
| mrw         | Warning     | 4933     | Ignored the recovery action in monitoring %1 because recovery action caused by monitor resource error is disabled. | not recovery (recovery action caused by monitor resource error has disabled)                                                                             |                                                                                           | •     | •         | •        |             |           |                |         |
| mrw         | Information | 4934     | There was a notification (%1) from external. (detail: %2)                                                          | An error notification from external was received.                                                                                                        |                                                                                           | •     | •         | •        |             |           |                |         |
| jra         | Information | 20201    | %1: The status of Java VM to be monitored has been recovered normally.                                             | The status of Java VM to be monitored is normal.<br>%1: Name of the Java VM to be monitored                                                              |                                                                                           |       | •         |          |             |           |                |         |
| jra         | Error       | 20202    | %1: %2 to be monitored has become abnormal.                                                                        | The status of Java VM to be monitored is abnormal.<br>%1: Name of the Java VM to be monitored<br>%2: Error generation location at abnormality occurrence | Review the Java application that runs on Java VM to be monitored.                         |       |           | •        | •           |           |                |         |
| jra         | Error       | 20203    | %1: An error was detected during connection to the target to be monitored.                                         | Connection to Java VM to be monitored is invalid.<br>%1: Name of the Java VM to be monitored                                                             | Check whether the Java VM to be monitored is set properly and whether it is active.       |       |           | •        | •           |           |                |         |
| jra         | Warning     | 20204    | An error has occurred during writing to the log. %1, code = %2.                                                    | Log writing error<br>%1: Exception contents<br>%2: Error code                                                                                            | Check whether there is sufficient free disk space on the machine on which JRA is running. |       |           | •        |             |           |                |         |
| jra         | Warning     | 20205    | An error has occurred during log opening.                                                                          | Log opening error                                                                                                                                        | Check whether there is sufficient free disk space on the machine on which JRA is running. |       |           | •        |             |           |                |         |
| jra         | Warning     | 20206    | %1: An error has occurred when creating a file.                                                                    | File creation error<br>%1: Name of the Java VM to be monitored                                                                                           | Check whether there is sufficient free disk space on the machine on which JRA is running. |       |           | •        |             |           |                |         |
| jra         | Warning     | 20207    | %1: An error has occurred when deleting a file.                                                                    | File deletion error<br>%1: Name of the Java VM to be monitored                                                                                           | Check that there is no problem with the hard disk of the machine on which JRA is running. |       |           | •        |             |           |                |         |
| jra         | Information | 20208    | Java Resource Agent has started.                                                                                   | Java Resource Agent has started.                                                                                                                         |                                                                                           |       |           | •        |             |           |                |         |



Messages reported by event log and alert

| Module Type | Event Type  | Event ID | Messages                                                                                                                                       | Description                                                                                                                              | Solution                                                 | Alert | Event log | User log | Mail report | SNMP Trap | Report setting |         |
|-------------|-------------|----------|------------------------------------------------------------------------------------------------------------------------------------------------|------------------------------------------------------------------------------------------------------------------------------------------|----------------------------------------------------------|-------|-----------|----------|-------------|-----------|----------------|---------|
|             |             |          |                                                                                                                                                |                                                                                                                                          |                                                          |       |           |          |             |           | Alive          | Manager |
| jra         | Error       | 20209    | %1: Notification has been received.<br>ObjectName=%2,<br>type=%3, message=%4                                                                   | WebOTX Notification has been received.<br>%1: Identifier<br>%2: ObjectName<br>%3: Notification type<br>%4: Reception message from WebOTX |                                                          |       | •         |          |             |           |                |         |
| jra         | Error       | 20251    | Internal processing has failed. (%1)                                                                                                           | An internal error occurred.<br>%1: Internal error code                                                                                   | Check if JRA is running. If not, restart the server.     |       | •         |          |             |           |                |         |
| jra         | Error       | 20252    | Startup has failed due to an error of the setting value. (%1)                                                                                  | Specified setting value is invalid.<br>%1: Internal error code                                                                           | Check if the Java installation path is correct.          |       | •         |          |             |           |                |         |
| sra         | Error       | 20301    | Service was terminated because reading an SG file failed.                                                                                      | An error occurred in reading the setting file.                                                                                           | Check the message separately issued.                     |       | •         |          |             |           |                |         |
| sra         | Error       | 20302    | The installation folder name could not be acquired.                                                                                            | The installation folder name could not be acquired.                                                                                      | Restart the cluster, or execute the suspend and resume.  |       | •         |          |             |           |                |         |
| sra         | Error       | 20305    | No IModules could be loaded.                                                                                                                   | Some files required to execute this product do not exist. So, this product failed to start.                                              | Install this product again.                              |       | •         |          |             |           |                |         |
| sra         | Error       | 20306    | An unexpected error occurred.                                                                                                                  | An attempt was made to start this product, but failed for some reason or another.                                                        | Restart the cluster, or execute the suspend and resume.  |       | •         |          |             |           |                |         |
| sra         | Error       | 20307    | Internal error occurred.                                                                                                                       | This product has terminated abnormally.                                                                                                  | See the system log message issued last.                  |       | •         |          |             |           |                |         |
| sra         | Error       | 20308    | An error has occurred in issuing WMI. %1(ErrorID:0x%2 class:%3)<br>%1: Message<br>%2: Error code<br>%3: Information that could not be acquired | Statistics information could not be acquired.<br>%1: Message<br>%2: Error code<br>%3: Information that could not be acquired             | Restart the cluster, or execute the suspend and resume.  |       | •         |          |             |           |                |         |
| sra         | Warning     | 20336    | Script is timeout. (%1 %2)<br>%1: Script file name<br>%2: Argument                                                                             | An internal error has occurred.                                                                                                          | Check the load status of the server and remove the load. |       | •         |          |             |           |                |         |
| sra         | Information | 20346    | %1 event succeeded.<br>%1: Event type (Boot, Shutdown, Stop, Start, or Flush)                                                                  | The operation management command has been executed.<br>The executed event type %1 (boot, shutdown, stop, start, or flush) is output.     | -                                                        |       | •         |          |             |           |                |         |

| Module Type | Event Type | Event ID | Messages                                                 | Description                                                                                                              | Solution                                   | Alert | Event log | User log | Mail report | SNMP Trap | Report setting | Manager Alive |
|-------------|------------|----------|----------------------------------------------------------|--------------------------------------------------------------------------------------------------------------------------|--------------------------------------------|-------|-----------|----------|-------------|-----------|----------------|---------------|
|             |            |          |                                                          |                                                                                                                          |                                            |       |           |          |             |           |                |               |
| sra         | Warning    | 20347    | %1 was smaller than %2, it changed to minimum value(%3). | The configuration value of the monitoring is not correct.<br>%1:Variable name<br>%2:Variable name<br>%3:configured value | Check the configured value on the Builder. |       | •         |          |             |           |                |               |
| sra         | Warning    | 20348    | %1 was too long compared with %2, it changed to %1(%3).  | The configuration value of the monitoring is not correct.<br>%1:Variable name<br>%2:Variable name<br>%3:configured value | Check the configured value on the Builder. |       | •         |          |             |           |                |               |
| sra         | Warning    | 20349    | %1 was smaller than %2, it changed to %2 value(%3).      | The configuration value of the monitoring is not correct.<br>%1:Variable name<br>%2:Variable name<br>%3:configured value | Check the configured value on the Builder. |       | •         |          |             |           |                |               |
| sra         | Warning    | 20350    | %1 was larger than %2, it changed to %2 value(%3).       | The configuration value of the monitoring is not correct.<br>%1:Variable name<br>%2:Variable name<br>%3:configured value | Check the configured value on the Builder. |       | •         |          |             |           |                |               |
| sra         | Warning    | 20351    | %1 was over than Total disk size, %2.                    | The configuration value of the monitoring is not correct.<br>%1:Variable name<br>%2:configured value                     | Check the configured value on the Builder. |       | •         |          |             |           |                |               |
| sra         | Warning    | 20352    | %1 was over than Total disk size, %2.                    | The configuration value of the monitoring is not correct.<br>%1:Variable name<br>%2:configured value                     | Check the configured value on the Builder. |       | •         |          |             |           |                |               |
| sra         | Warning    | 20353    | Delete MOUNT[%1] in DiskCapacity list.                   | The configuration value of the monitoring is not correct.<br>%1:configured value                                         | Check the configured value on the Builder. |       | •         |          |             |           |                |               |
| sra         | Warning    | 20354    | %1 was illegal value (%2).                               | The configuration value of the monitoring is not correct.<br>%1:Variable name<br>%2:configured value                     | Check the configured value on the Builder. |       | •         |          |             |           |                |               |

Messages reported by event log and alert

| Module Type | Event Type | Event ID | Messages                                                                           | Description                                                                                            | Solution                                                                                                                                     | Alert | Event log | User log | Mail report | SNMP Trap | Report setting | Manager |
|-------------|------------|----------|------------------------------------------------------------------------------------|--------------------------------------------------------------------------------------------------------|----------------------------------------------------------------------------------------------------------------------------------------------|-------|-----------|----------|-------------|-----------|----------------|---------|
|             |            |          |                                                                                    |                                                                                                        |                                                                                                                                              |       |           |          |             |           | Alive          |         |
| sra         | Warning    | 20355    | The DriveLetter of %1 is not ready, or Drive type was not fixed.(DriveLetter = %2) | The configuration value of the monitoring is not correct.<br>%1: Variable name<br>%2: configured value | Check the configured value on the Builder.                                                                                                   |       | •         |          |             |           |                |         |
| sra         | Error      | 20358    | Process resource error was detected(type = %1, pid = %2, %3).                      | A process resource error was detected.<br>%1: Resource type<br>%2: Process ID<br>%3: Process name      | Check the possible causes of the monitoring failure.                                                                                         | •     | •         |          |             |           |                |         |
| sra         | Error      | 20359    | System resource error was detected(type = %1).                                     | A system resource error was detected.<br>%1: Resource type                                             | Check the possible causes of the monitoring failure.                                                                                         | •     | •         |          |             |           |                |         |
| sra         | Error      | 20360    | Disk resource error was detected(type = %1, level = %2, %3).                       | A disk resource error was detected.<br>%1: Resource type<br>%2: Monitor level<br>%3: Drive letter name | Check the possible causes of the monitoring failure.                                                                                         | •     | •         |          |             |           |                |         |
| ddns        | Error      | 5051     | Failed to register the virtual host name (%1) to the DNS server.                   | DNS registration failure<br>%1: Virtual host name                                                      | Check whether an error occurred in the DNS server, or whether an error occurred in communication with the DNS server.                        | •     | •         |          |             |           |                |         |
| ddns        | Error      | 5052     | Failed to delete the virtual host name (%1) from the DNS server.                   | Failure of deletion of DNS registration<br>%1: Virtual host name                                       | Check whether an error occurred in the DNS server, or whether an error occurred in communication with the DNS server.                        | •     | •         |          |             |           |                |         |
| ddns        | Error      | 5053     | Failed to disable the Kerberos Authentication (irtual host name: %1).              | Failure of disabling Kerberos Authentication<br>%1: Virtual host name                                  | Check if there is an error in Kerberos Authentication server (KDC) or a problem of communications with Kerberos Authentication server (KDC). | •     | •         |          |             |           |                |         |

## Driver event log messages

### Disk filter driver

The following events are recorded in system event log as the source “clpdiskfltr”.

| Module Type | Event Type | Event ID | Message                                                                                                                                                     | Description                                                                                                                                                                                        | Solution                                                                                                                                                                                  |
|-------------|------------|----------|-------------------------------------------------------------------------------------------------------------------------------------------------------------|----------------------------------------------------------------------------------------------------------------------------------------------------------------------------------------------------|-------------------------------------------------------------------------------------------------------------------------------------------------------------------------------------------|
| diskfltr    | Info       | 1001     | Mirror disk resource activated without mirroring achieved.(%1)                                                                                              | Mirror disk resource has been activated without connecting to the mirror connect.<br>%1: mirror disk number                                                                                        | Mirror disk resource has been activated while the other server is not in normal state such as in failover or access restriction release. Make sure there is no error in the other server. |
| diskfltr    | Info       | 1002     | The mirror disk connect of mirror disk %1 is available. (Priority %2)                                                                                       | The standby mirror disk connect has been recovered.<br>The degenerated state has changed to the redundant state.<br>%1: Mirror disk number<br>%2: Priority number                                  | -                                                                                                                                                                                         |
| diskfltr    | Info       | 1003     | The mirror disk connect used for mirror data communication of mirror disk %1 has been changed due to a user request. (Priority %2 -> %3)                    | The active mirror disk connect has been changed due to a manual change request.<br>%1: Mirror disk number<br>%2: Priority number before switching<br>%3: Priority number after switching           | -                                                                                                                                                                                         |
| diskfltr    | Info       | 1004     | The mirror disk connect used for mirror data communication of mirror disk %1 has been changed due to a request from the sending server. (Priority %2 -> %3) | The active mirror disk connect has been changed due to a request from the sending server.<br>%1: Mirror disk number<br>%2: Priority number before switching<br>%3: Priority number after switching | Make sure there is no error in the network.                                                                                                                                               |
| diskfltr    | Info       | 1005     | The operation of compressing mirror communication data of mirror disk %1 has been changed (%2).                                                             | The mirror communication data compression method has been changed to one different from the specified method.                                                                                      | -                                                                                                                                                                                         |
| diskfltr    | Info       | 1006     | The mirror disk has been activated in compatible mode. The version of the driver is different from that of the mirror destination server (%1).              | The version of the EXPRESSCLUSTER on the destination server is old.<br>%1: Mirror disk number                                                                                                      | Make sure the version of the installed EXPRESSCLUSTER is the same.                                                                                                                        |
| diskfltr    | Info       | 1007     | An error occurred when the mirror disk connect was initialized. (%1)                                                                                        | Because an error occurred during initialization of the mirror disk connect, the target mirror disk connect is not available.<br>%1: IP address of the mirror disk connect                          | Make sure there is no error in the network.                                                                                                                                               |

| Module Type | Event Type | Event ID | Message                            | Description                                                                                                     | Solution                                                                                                                                                                       |
|-------------|------------|----------|------------------------------------|-----------------------------------------------------------------------------------------------------------------|--------------------------------------------------------------------------------------------------------------------------------------------------------------------------------|
| diskfltr    | Error      | 2001     | Mirror disk connect error.(%1)     | Disconnected: Disconnection has been detected in the mirror connect.                                            | Make sure there is no error in the network.                                                                                                                                    |
|             |            |          |                                    | Timeout - HealthCheck: There was no response from the other server.                                             | Same as above.                                                                                                                                                                 |
|             |            |          |                                    | Timeout - 1stAck: There was no response from the other server.                                                  | Make sure there is no error in the network or the other server.                                                                                                                |
|             |            |          |                                    | Timeout - 2ndAck: There was no response from the other server.                                                  | Same as above.                                                                                                                                                                 |
|             |            |          |                                    | Mirror DP Not Found: The data partition of the other server cannot be found.                                    | Make sure there is no error in the data partition of the other server.                                                                                                         |
| diskfltr    | Error      | 2002     | Asynchronized transfer error.(%1)  | Timeout - Get KernelQueue: Timeout occurred in asynchronized transfer.                                          | An error occurred in the user process of asynchronized transfer. Check that the clpdiskagent process is running normally, and that there is no error in I/O to the local disk. |
|             |            |          |                                    | History Overflow: The number of the items to be recorded as history was exceeded, so mirroring was interrupted. | Consider to decrease the process to write asynchronized transfer or improve the speed of circuit.                                                                              |
| diskfltr    | Error      | 2003     | Mirror disk access error(DP).( %1) | Accessing the mirror disk failed.<br>%1: mirror disk number                                                     | Make sure there is no error in the data partition of the mirror disk. In case of an error, exchange the disk for the one without an error.                                     |
| diskfltr    | Error      | 2004     | Mirror disk access error(CP).( %1) | Failed to record the difference information on the cluster partition.<br>%1: mirror disk number                 | Make sure there is no error in the cluster partition of the mirror disk. In case of an error, exchange the disk for the one without an error.                                  |
| diskfltr    | Error      | 2005     | Cluster partition access error.    | Accessing the cluster portion failed.                                                                           | Make sure there is no error in the cluster partition of the mirror disk. In case of an error, exchange the disk for the one without an error.                                  |
| diskfltr    | Error      | 2006     | Mirror disk activation error.(%1)  | Standby: Mirror disk is already being operated as the standby system.                                           | An error in operation is considered to have caused this error. Check the cause of this error.                                                                                  |
|             |            |          |                                    | Already opened: Mirror disk is already being operated as the active system.                                     | Same as above.                                                                                                                                                                 |

| Module Type | Event Type | Event ID | Message                                                                                                                                         | Description                                                                                                                                                                                                                                          | Solution                                                                                                                          |
|-------------|------------|----------|-------------------------------------------------------------------------------------------------------------------------------------------------|------------------------------------------------------------------------------------------------------------------------------------------------------------------------------------------------------------------------------------------------------|-----------------------------------------------------------------------------------------------------------------------------------|
|             |            |          |                                                                                                                                                 | Refused by other: The status of the other server is wrong. (It is being activated now.)                                                                                                                                                              | Same as above.                                                                                                                    |
| diskfltr    | Error      | 2099     | Internal error.                                                                                                                                 | An internal error occurred.                                                                                                                                                                                                                          | Insufficient kernel memory or OS resource is considered to have caused this error. Check this error with the performance monitor. |
| diskfltr    | Warning    | 3001     | The mirror disk connect used for mirror data communication of mirror disk %1 has been changed due to a communication error. (Priority %2 -> %3) | Disconnection of the active mirror disk connect has been detected. The mirror disk connect will be switched and mirror disk connect %3 will be used. %1: Mirror disk number %2: Priority number before switching %3: Priority number after switching | Make sure there is no error in the network.                                                                                       |
| diskfltr    | Warning    | 3002     | The mirror disk connect of mirror disk %1 is unavailable. (Priority %2)                                                                         | Disconnection of the standby mirror disk connect has been detected. %1: Mirror disk number %2: Priority number                                                                                                                                       | Make sure there is no error in the network.                                                                                       |
| diskfltr    | Error      | 5001     | Connection error on mirror disk connect.(%1)                                                                                                    | Connecting to the mirror connect failed.                                                                                                                                                                                                             | Make sure there is no error in the network or the mirror connect settings.                                                        |
| diskfltr    | Error      | 5002     | Communication error on mirror disk connect.(%1)                                                                                                 | Because the network has an error or is highly loaded, the mirror connect is disconnected.                                                                                                                                                            | Make sure there is no error in the network.                                                                                       |
| diskfltr    | Error      | 5003     | History file access error.(%1)                                                                                                                  | Failed to write or read the history file.                                                                                                                                                                                                            | Make sure there is no error in the hard disk. In case of an error, exchange the disk for the one without an error.                |
| diskfltr    | Error      | 5004     | Mirror disk virtual device access error.(%1)                                                                                                    | Failed to obtain the data from the mirror disk virtual driver.                                                                                                                                                                                       | The mirror disk virtual driver is not running normally or has an error. Check that EXPRESSCLUSTER has been set up correctly.      |
| diskfltr    | Error      | 5005     | Mirror disk connect timeout.(%1)                                                                                                                | The network has an error or is highly loaded, the mirror connect is disconnected.                                                                                                                                                                    | Make sure there is no error in the network or the other server.                                                                   |
| diskfltr    | Error      | 5006     | History file disk overflow.(%1)                                                                                                                 | Failed to output the history file because of insufficient disk capacity.                                                                                                                                                                             | The folder to store the history file does not have enough. Set the folder with enough capacity.                                   |
| diskfltr    | Error      | 5007     | Queue buffer allocation error.(%1)                                                                                                              | Failed to allocate the buffer for asynchronous transfer.                                                                                                                                                                                             | Insufficient memory or OS resource is considered to have caused this error. Check the cause.                                      |

| Module Type | Event Type | Event ID | Message             | Description                 | Solution                                                                                     |
|-------------|------------|----------|---------------------|-----------------------------|----------------------------------------------------------------------------------------------|
| diskfltr    | Error      | 5099     | Internal error.(%1) | An internal error occurred. | Insufficient memory or OS resource is considered to have caused this error. Check the cause. |

## Kernel mode LAN heartbeat driver

The following events are recorded in system event log as the source “clphb”.

| Module Type | Event Type | Event ID | Message                                                                     | Description                         | Solution                                                                            |
|-------------|------------|----------|-----------------------------------------------------------------------------|-------------------------------------|-------------------------------------------------------------------------------------|
| clphb       | Error      | 3001     | Fatal error occurred in the driver.                                         | Fatal error occurred in the driver. | Kernel memory or OS resource may not be sufficient. Check with performance monitor. |
| clphb       | Info       | 1001     | Signal has been set to the shutdown event due to the keep alive timeout.    | User mode is stalled.               | Kernel memory or OS resource may not be sufficient. Check with performance monitor. |
| clphb       | Info       | 1002     | Signal has been set to the shutdown event due to the FILTER closing action. | Received FILTER closing action.     | Kernel memory or OS resource may not be sufficient. Check with performance monitor. |

## Detailed information in activating and deactivating group resources

The following information is displayed in the messages recorded in event logs or alert viewer as detail information when the resource activation / deactivation fails.

### Application resource

| Module Type | Type  | Return Value | Message                          | Description                                                     | Solution                                                                         |
|-------------|-------|--------------|----------------------------------|-----------------------------------------------------------------|----------------------------------------------------------------------------------|
| appli       | Error | 5            | The application path is invalid. | The application path is invalid.                                | Check if the application path is correct.                                        |
| appli       | Error | 7            | Failed to start application.     | Failed to start application.                                    | Memory or OS resources may not be sufficient. Check them.                        |
| appli       | Error | 8            | Failed to stop application.      | Failed to stop application.                                     | Memory or OS resources may not be sufficient. Check them.                        |
| appli       | Error | 10           | Timeout occurred.                | Timeout occurred.                                               | Check if the application terminates within the timeout period.                   |
| appli       | Error | 11           | Failed to log on as a user.      | Failed to log on as a user.                                     | Check if a domain, an account and a password of the logon user are set properly. |
| appli       | Error | 12           | Returned exit code %1.           | The non-resident type application returned abnormal error code. | Check the cause for the abnormal error code.                                     |
| appli       | Error | Others       | Internal error occurred.         | Internal error occurred.                                        | Memory or OS resources may not be sufficient. Check them.                        |

### CIFS Resource

| Module Type | Type  | Return Value | Message                                          | Description                                                               | Solution                                                                             |
|-------------|-------|--------------|--------------------------------------------------|---------------------------------------------------------------------------|--------------------------------------------------------------------------------------|
| cifs        | Error | 2            | The specified path is invalid.                   | The specified path is invalid.                                            | Correct the setting of target folder.                                                |
| cifs        | Error | 3            | Access denied.                                   | Access denied.                                                            | Check if local system account has the appropriate access right to the target folder. |
| cifs        | Error | 4            | The share name is already in use on this server. | The specified name of the shared folder is already in use on this server. | Correct the setting of shared name.                                                  |
| cifs        | Error | 5            | The specified path does not exist.               | The specified path does not exist.                                        | Correct the setting of target folder.                                                |
| cifs        | Error | 6            | Insufficient memory is available.                | Insufficient memory is available.                                         | Memory or OS resources may not be sufficient. Check them.                            |



| Module Type | Type  | Return Value | Message                                        | Description                                                                                    | Solution                                                                                                           |
|-------------|-------|--------------|------------------------------------------------|------------------------------------------------------------------------------------------------|--------------------------------------------------------------------------------------------------------------------|
| cifs        | Error | 7            | The specified folder can not be found.         | The specified folder can not be found.                                                         | Correct the setting of target folder.                                                                              |
| cifs        | Error | 8            | The specified shared name cannot be found.     | The shared folder to be monitored does not exist.                                              | Check if the shared configuration has not been released.                                                           |
| cifs        | Error | 10           | Failed to set the caching.                     | Failed to set the caching.                                                                     | Check if local system account has the appropriate access right to the target folder.                               |
| cifs        | Error | 11           | Failed to set security information.            | Failed to set security information.                                                            | Check if local system account has the appropriate access right to the target folder.                               |
| cifs        | Error | 15           | The shared configuration file path is wrong.   | Specified path does not exist, or invalid character strings are used in the absolute path.     | Correct the configuration value.                                                                                   |
| cifs        | Error | 17           | Failed to write the shared configuration file. | Failed to save the shared configuration in the file.                                           | Check if the writing to the shared configuration file is available with the local system account.                  |
| cifs        | Error | 18           | Failed to read the shared configuration file.  | Failed to read the shared configuration from the file.                                         | Check if the reading from the shared configuration file is available with the local system account.                |
| cifs        | Error | 20           | Failed to start up CIFS control process.       | Failed to start up the process (clpcifsp.exe) that monitors the change of shared configuration | There may be corruption of the execution file, lack of memory capacity or lack of OS resource. Check these issues. |
| cifs        | Error | 25           | Failed to set comments for the shared folder.  | Failed to set comments for the shared folder.                                                  | Check the access right for the local system account and the shared name of the shared folder.                      |
| cifs        | Error | Others       | Internal error occurred.                       | Internal error occurred.                                                                       | Memory or OS resources may not be sufficient. Check them.                                                          |

## Floating IP resource

| Module Type | Type  | Return Value | Message                           | Description                       | Solution                                                                                     |
|-------------|-------|--------------|-----------------------------------|-----------------------------------|----------------------------------------------------------------------------------------------|
| fip         | Error | 5            | IP address already exists.        | IP address already exists.        | Check if the IP address is already used on the network. Set the IP address that is not used. |
| fip         | Error | 8            | Available adapter does not exist. | Available adapter does not exist. | Check if the FIP address network is the same as the server's real IP address.                |

| Module Type | Type  | Return Value | Message                      | Description                  | Solution                                                                          |
|-------------|-------|--------------|------------------------------|------------------------------|-----------------------------------------------------------------------------------|
| fip         | Error | 9            | Failed to add IP address.    | Failed to add IP address.    | Check the result of the ipconfig command. If 0.0.0.0 address exists, restart NIC. |
| fip         | Error | 10           | Failed to delete IP address. | Failed to delete IP address. | Memory or OS resources may not be sufficient. Check them.                         |
| fip         | Error | 99           | Internal error occurred.     | Internal error occurred.     | Memory or OS resources may not be sufficient. Check them.                         |

### Mirror disk resource / hybrid disk resource

| Module Type | Type  | Return Value | Message                                                  | Description                                              | Solution                                                                                                            |
|-------------|-------|--------------|----------------------------------------------------------|----------------------------------------------------------|---------------------------------------------------------------------------------------------------------------------|
| md/hd       | Error | 2            | An internal error occurred.                              | An internal error occurred.                              | Memory or OS resources may not be sufficient. Check them.                                                           |
| md/hd       | Error | 2            | The resource is busy.                                    | The resource is busy.                                    | The partition may be in use. Wait for a while, and retry the operation.                                             |
| md/hd       | Error | 2            | A network error occurred.                                | A network error occurred.                                | Check the status of the interconnect connection.                                                                    |
| md/hd       | Error | 2            | Cannot establish the mirror disk connection.             | Cannot establish the mirror disk connection.             | Check if the cluster configuration data is correct.                                                                 |
| md/hd       | Error | 2            | The resource name is invalid.                            | The resource name is invalid.                            | Check if the cluster configuration data is correct.                                                                 |
| md/hd       | Error | 2            | The status is invalid.                                   | The status is invalid.                                   | You need to perform the mirror recovery.                                                                            |
| md/hd       | Error | 2            | The resource is not initialized.                         | The resource is not initialized.                         | Check if the partition is allocated and OS recognizes the disk. Check if the cluster configuration data is correct. |
| md/hd       | Error | 2            | The resource is not performed first mirror construction. | The resource is not performed first mirror construction. | You need to perform the initial mirror construction.                                                                |
| md/hd       | Error | 2            | Cannot lock the mirror disk.                             | Cannot lock the mirror disk.                             | Memory or OS resources may not be sufficient. Check them.                                                           |
| md/hd       | Error | 2            | The license is not registered.                           | The license is not registered.                           | Register the license.                                                                                               |
| md/hd       | Error | 2            | The trial version has expired.                           | The trial version has expired.                           | Register the license.                                                                                               |
| md/hd       | Error | 2            | The license authentication failed.                       | The license authentication failed.                       | Register the license.                                                                                               |

| Module Type | Type  | Return Value | Message                                                        | Description                                                    | Solution                                                                                                                                |
|-------------|-------|--------------|----------------------------------------------------------------|----------------------------------------------------------------|-----------------------------------------------------------------------------------------------------------------------------------------|
| md/hd       | Error | 2            | Cannot find the history folder.                                | Cannot find the history folder.                                | Check if the cluster configuration data is correct.                                                                                     |
| md/hd       | Error | 2            | The mirror connect is not initialized.                         | The mirror connect is not initialized.                         | Check the status of the mirror connect. Check if the cluster configuration data is correct.                                             |
| md/hd       | Error | 2            | Cannot find the partition specified for the cluster partition. | Cannot find the partition specified for the cluster partition. | Check if the partition is allocated and the OS recognizes the disk.                                                                     |
| md/hd       | Error | 2            | Cannot find the partition specified for the data partition.    | Cannot find the partition specified for the data partition.    | Check if the partition is allocated and the OS recognizes the disk.                                                                     |
| md/hd       | Error | 2            | Cannot change the drive letter for the cluster partition.      | Cannot change the drive letter for the cluster partition.      | Check if the drive letter for the cluster configuration data is specified. Check if the drive letter is not used for another partition. |
| md/hd       | Error | 2            | Cannot change the drive letter for the data partition.         | Cannot change the drive letter for the data partition.         | Check if the drive letter for the cluster configuration data is specified. Check if the drive letter is not used for another partition. |
| md/hd       | Error | 2            | The server name is invalid.                                    | The server name is invalid.                                    | Check if the cluster configuration data is correct.                                                                                     |

## NAS Resource

| Module Type | Type  | Return Value | Message                                   | Description                                                                 | Solution                                                                                       |
|-------------|-------|--------------|-------------------------------------------|-----------------------------------------------------------------------------|------------------------------------------------------------------------------------------------|
| nas         | Error | 1            | The drive has already been used.          | The specified drive letter has already been used for another network drive. | Change the drive letter.                                                                       |
| nas         | Error | 3            | Invalid nas drive.                        | The specified drive letter has already been used for another drive.         | Change the drive letter.                                                                       |
| nas         | Error | 4            | Failed to redirect the network resource . | Failed to mount the network drive.                                          | Check if the specified network resource is accessible with the specified account and password. |
| nas         | Error | Others       | Internal error occurred.                  | Internal error occurred.                                                    | Memory or OS resources may not be sufficient. Check them.                                      |

## Registry synchronization resource

| Module Type | Type  | Return Value | Message                                                                                     | Description                                                                                                                                  | Solution                                                                                                                                             |
|-------------|-------|--------------|---------------------------------------------------------------------------------------------|----------------------------------------------------------------------------------------------------------------------------------------------|------------------------------------------------------------------------------------------------------------------------------------------------------|
| regsync     | Error | 2            | Timeout has occurred while waiting for completion of synchronization processing at startup. | The resource cannot be activated because synchronization of registry files between servers has not been completed.                           | Activate the resource again after a while. If the error persists, OS may have errors. Check the status of the system.                                |
| regsync     | Error | 2            | Timeout occurred when waiting for completing initialization of resource thread.             | Activating the resource failed because initialization process of the thread has not been completed.                                          | OS may have errors. Check the status of the system.                                                                                                  |
| regsync     | Error | 2            | Timeout occurred when waiting for completing termination of resource thread.                | Deactivating the resource failed because termination process of the thread has not been completed.                                           | OS may have errors. Check the status of the system.                                                                                                  |
| regsync     | Error | 4            | Specified resource does not exist in cluster configuration data.                            | Activating or deactivating the resource failed because it does not exist on the cluster configuration data.                                  | Check if the resource name is consistent with the information in the cluster configuration data.                                                     |
| regsync     | Error | 5            | Failed to allocate memory.                                                                  | Activating the resource failed because the memory cannot be allocated.                                                                       | Memory or OS resources may not be sufficient. Check the status of the system.                                                                        |
| regsync     | Error | 6            | Failed to get OS resource.                                                                  | Activating the resource failed because OS resource cannot be obtained.                                                                       | Memory or OS resources may not be sufficient. Check the status of the system.                                                                        |
| regsync     | Error | 6            | Failed to create thread.                                                                    | Activating the resource failed because the thread cannot be created.                                                                         | Memory or OS resources may not be sufficient. Check the status of the system.                                                                        |
| regsync     | Error | 7            | Failed to open registry.                                                                    | Opening the registry failed because invalid registry key is registered to the resource.                                                      | Check the value set on the Builder ( <b>Details on Resource Properties</b> ), and change to a correct registry key.                                  |
| regsync     | Error | 7            | Failed to restore registry.                                                                 | Restoring the registry failed because invalid registry key is registered to the resource.                                                    | Check the value set on the Builder ( <b>Details on Resource Properties</b> ), and change to a correct registry key.                                  |
| regsync     | Error | 8            | Failed to open registry.                                                                    | Opening the registry failed because the registry key registered to the resource does not exist on the registry, or Win32 API error occurred. | Check if the registry key exists on the registry. If it does not exist, create it. If it exists, OS may have errors. Check the status of the system. |

| Module Type | Type  | Return Value | Message                                           | Description                                                                                                                                                                                                        | Solution                                                                                                                                                                                                                                                                            |
|-------------|-------|--------------|---------------------------------------------------|--------------------------------------------------------------------------------------------------------------------------------------------------------------------------------------------------------------------|-------------------------------------------------------------------------------------------------------------------------------------------------------------------------------------------------------------------------------------------------------------------------------------|
| regsync     | Error | 8            | Failed to restore registry.                       | Opening the registry failed because the registry key registered to the resource does not exist on the registry, other process opens the registry key, or the system call for registry operation returned an error. | Check if the registry key exists on the registry. If it does not exist, create it. If it exists, check if a process other than EXPRESSCLUSTER opens the registry key. If the registry key exists and no other process opens it, OS may have errors. Check the status of the system. |
| regsync     | Error | 9            | Failed to lock file.                              | Locking a file failed when operating the registry storage file.                                                                                                                                                    | Check if the process other than EXPRESSCLUSTER opens the registry storage file.                                                                                                                                                                                                     |
| regsync     | Error | 9            | Failed to input/output the file.                  | The input/output process of the file failed when operating the registry storage file.                                                                                                                              | Check if the process other than EXPRESSCLUSTER opens the registry storage file.<br>OS may have errors. Check the status of the system.                                                                                                                                              |
| regsync     | Error | 12           | Synchronization processing at startup has failed. | The resource cannot be activated because synchronization process of the registry storage file between servers failed.                                                                                              | OS may have errors. Check the status of the system.                                                                                                                                                                                                                                 |

## Script resource

| Module Type | Type  | Return Value | Message                         | Description                                               | Solution                                                  |
|-------------|-------|--------------|---------------------------------|-----------------------------------------------------------|-----------------------------------------------------------|
| script      | Error | 6            | Failed to execute start script. | Failed to execute start script.                           | Memory or OS resources may not be sufficient. Check them. |
| script      | Error | 7            | Failed to execute stop script.  | Failed to execute stop script.                            | Memory or OS resources may not be sufficient. Check them. |
| script      | Error | 8            | Returned exit code %1.          | The synchronous type script returned abnormal error code. | Check the cause for the abnormal error code.              |
| script      | Error | 9            | Timeout occurred.               | Timeout occurred.                                         | Check if the script terminates within the timeout period. |
| script      | Error | Others       | Internal error occurred.        | Internal error occurred.                                  | Memory or OS resources may not be sufficient. Check them. |

## Disk resource

| Module Type | Type  | Return Value | Message                                                     | Description                                                 | Solution                                                                      |
|-------------|-------|--------------|-------------------------------------------------------------|-------------------------------------------------------------|-------------------------------------------------------------------------------|
| sd          | Error | -1           | Internal error occurred.                                    | Internal error occurred.                                    | Memory or OS resources may not be sufficient. Check them.                     |
| sd          | Error | -1           | Failed to load cluster configuration data.                  | Failed to load cluster configuration data.                  | Check if the cluster configuration data is stored on a proper location.       |
| sd          | Error | -1           | Failed to unload cluster configuration data.                | Failed to unload cluster configuration data.                | Check if the cluster configuration data is stored on a proper location.       |
| sd          | Error | -1           | Failed to get cluster configuration data.                   | Failed to get cluster configuration data.                   | Check if the cluster configuration data is correct.                           |
| sd          | Error | -1           | Failed to allocate memory.                                  | Failed to allocate memory.                                  | Memory or OS resources may not be sufficient. Check them.                     |
| sd          | Error | -1           | Failed to activate resource.                                | Failed to activate resource.                                | Check if the HBA settings are correct. The partition may be in use. Check it. |
| sd          | Error | -1           | Failed to create thread.                                    | Failed to create thread.                                    | Memory or OS resources may not be sufficient. Check them.                     |
| sd          | Error | -1           | Timeout occurred on thread.                                 | Timeout occurred on thread.                                 | Memory or OS resources may not be sufficient. Check them.                     |
| sd          | Error | -1           | Failed to dismount the partition specified by the resource. | Failed to dismount the partition specified by the resource. | The partition may be in use. Check it.                                        |
| sd          | Error | -1           | Failed to lock the partition specified by the resource.     | Failed to lock the partition specified by the resource.     | The partition may be in use. Check it.                                        |
| sd          | Error | -1           | Failed to deactivate resource.                              | Failed to deactivate resource.                              | Check if the HBA settings are correct.                                        |
| sd          | Error | -1           | Server does not exist in cluster configuration data.        | Server does not exist in cluster configuration data.        | Check if the server exists in the cluster configuration data.                 |
| sd          | Error | -1           | Resource does not exist in cluster configuration data.      | Resource does not exist in cluster configuration data.      | Check if the resource exists in the cluster configuration data.               |
| sd          | Error | -1           | Cannot find the specified partition.                        | Cannot find the specified partition.                        | Check if OS recognizes the specified partition.                               |
| sd          | Error | -1           | Cannot change the drive letter.                             | Cannot change the drive letter.                             | Check if the specified drive letter is used for another partition.            |

## Service resource

| Module Type | Type  | Return Value | Message                                                                                                           | Description                                                                                                       | Solution                                                                                                                           |
|-------------|-------|--------------|-------------------------------------------------------------------------------------------------------------------|-------------------------------------------------------------------------------------------------------------------|------------------------------------------------------------------------------------------------------------------------------------|
| service     | Error | 5            | Failed to get service control right.                                                                              | Failed to get service control right.                                                                              | Check if the service name is correct.                                                                                              |
| service     | Error | 6            | Failed to start service.                                                                                          | Failed to start service.                                                                                          | Check the status of the service.                                                                                                   |
| service     | Error | 7            | Failed to stop service.                                                                                           | Failed to stop service.                                                                                           | Check the status of the service.                                                                                                   |
| service     | Error | 8            | Service has already been running.                                                                                 | Service has already been running.                                                                                 | Check the status of the service. It is possible to configure settings not to make it an error when the service is already running. |
| service     | Error | 10           | Timeout occurred.                                                                                                 | Timeout occurred.                                                                                                 | Check if the service starts or stops within the timeout period.                                                                    |
| service     | Error | 13           | Computer name related to service that is running is different from virtual computer name of target VCOM resource. | Computer name related to service that is running is different from virtual computer name of target VCOM resource. | When you set the same service to more than one service, do not set the target VCOM resource name.                                  |
| service     | Error | Others       | Internal error occurred.                                                                                          | Internal error occurred.                                                                                          | Memory or OS resources may not be sufficient. Check them.                                                                          |

## Print spooler resource

| Module Type | Type  | Return Value | Message                                       | Description                                   | Solution                                                                                                                                              |
|-------------|-------|--------------|-----------------------------------------------|-----------------------------------------------|-------------------------------------------------------------------------------------------------------------------------------------------------------|
| spool       | Error | 5            | Failed to stop service.                       | Failed to stop service.                       | Stopping the spooler service failed. Check if the printer setting is correct.                                                                         |
| spool       | Error | 4            | Failed to start service.                      | Failed to start service.                      | Starting the spooler service failed. Check if the printer setting is correct.                                                                         |
| spool       | Error | Other        | Internal error occurred.(status:%1!d!)        | Internal error occurred.(status:%1!d!)        | The disk capacity or the memory of the server where EXPRESSCLUSTER is installed may not be sufficient. Check them.                                    |
| spool       | Error | 1            | Failed to create a specified spool directory. | Failed to create a specified spool directory. | Check if activating the disk resource or the mirror disk resource fails.<br>Check if characters that cannot be used in a directory name are included. |

| Module Type | Type  | Return Value | Message                                                     | Description                                                | Solution                                                                                                                                              |
|-------------|-------|--------------|-------------------------------------------------------------|------------------------------------------------------------|-------------------------------------------------------------------------------------------------------------------------------------------------------|
| spool       | Error | 1            | Failed to change a spool directory.                         | Failed to change a spool directory.                        | Check if activating the disk resource or the mirror disk resource fails.<br>Check if characters that cannot be used in a directory name are included. |
| spool       | Error | 2            | Config value(printer name) is invalid. resource:%1 value:%2 | Config value(printer name) is invalid. resource:%1value:%2 | Check if the printer name exists on the server.                                                                                                       |
| spool       | Error | 2            | Config value(partition) is invalid. resource:%1 value:%2    | Config value(partition) is invalid. resource:%1 value:%2   | Check if the drive letter is the one on the disk resource or the mirror disk resource.                                                                |
| spool       | Error | 2            | Config value(directory) is invalid. resource:%1 value:%2    | Config value(directory) is invalid. resource:%1 value:%2   | Check if characters that cannot be used in a directory name are included.                                                                             |

## Virtual computer name resource

| Module Type | Type  | Return Value | Message                                              | Description                                          | Solution                                                                     |
|-------------|-------|--------------|------------------------------------------------------|------------------------------------------------------|------------------------------------------------------------------------------|
| vcom        | Error | 5            | VCOM control process has already been started.       | VCOM control process has already been started.       | Memory or OS resources may not be sufficient. Check them.<br>Restart the OS. |
| vcom        | Error | 6            | VCOM control process has not been started.           | VCOM control process has not been started.           | Memory or OS resources may not be sufficient. Check them.<br>Restart the OS. |
| vcom        | Error | 8            | VCOM control process does not exist.                 | VCOM control process does not exist.                 | Memory or OS resources may not be sufficient. Check them.<br>Restart the OS. |
| vcom        | Error | 9            | Failed to get IP address table.                      | Failed to get IP address table.                      | Memory or OS resources may not be sufficient. Check them.                    |
| vcom        | Error | 10           | Target FIP address does not exist.                   | Target FIP address does not exist.                   | Check if the IP address of the target FIP resource exists.                   |
| vcom        | Error | 11           | Virtual computer name is the same as local hostname. | Virtual computer name is the same as local hostname. | Do not set existing host names for a virtual computer name.                  |
| vcom        | Error | 12           | Failed to start VCOM control process.                | Failed to start VCOM control process.                | Check if all conditions for using a virtual computer are met.                |



| Module Type | Type  | Return Value | Message                              | Description                          | Solution                                                                     |
|-------------|-------|--------------|--------------------------------------|--------------------------------------|------------------------------------------------------------------------------|
| vcom        | Error | 13           | Failed to stop VCOM control process. | Failed to stop VCOM control process. | An error occurred when stopping the virtual computer.<br><br>Restart the OS. |
| vcom        | Error | Others       | Internal error occurred.             | Internal error occurred.             | Memory or OS resources may not be sufficient. Check them.                    |

## Virtual IP resource

| Module Type | Type  | Return Value | Message                           | Description                       | Solution                                                                                            |
|-------------|-------|--------------|-----------------------------------|-----------------------------------|-----------------------------------------------------------------------------------------------------|
| vip         | Error | 5            | IP address already exists.        | IP address already exists.        | Check if the IP address is already used on the network.<br><br>Set the IP address that is not used. |
| vip         | Error | 8            | Available adapter does not exist. | Available adapter does not exist. | Check if the IP address set on the interconnect exists on the server. Set a proper IP address.      |
| vip         | Error | 9            | Failed to add IP address.         | Failed to add IP address.         | Check the result of the ipconfig command. If 0.0.0.0 address exists, restart NIC.                   |
| vip         | Error | 10           | Failed to delete IP address.      | Failed to delete IP address.      | Memory or OS resources may not be sufficient. Check them.                                           |
| vip         | Error | Others       | Internal error occurred.          | Internal error occurred.          | Memory or OS resources may not be sufficient. Check them.                                           |

## Virtual machine resource

| Module Type | Type  | Return Value | Message                                                         | Description                                                                               | Solution                                                                        |
|-------------|-------|--------------|-----------------------------------------------------------------|-------------------------------------------------------------------------------------------|---------------------------------------------------------------------------------|
| vm          | Error | 5            | Virtual Machine configuration data is invalid.                  | The configuration file of the virtual machine may be invalid.                             | Check if <b>VM configuration file path</b> is correct.                          |
| vm          | Error | 6            | Virtual machine has been already started.                       | The virtual machine failed to start because the virtual machine has been already started. | Check the status of the virtual machine.                                        |
| vm          | Error | 7            | Hyper-V Virtual Machine Management service has not started yet. | Hyper-V Virtual Machine Management has not started yet.                                   | Check the status of Hyper-V Virtual Machine Management service.                 |
| vm          | Error | 8            | Failed to start virtual machine.                                | Failed to start virtual machine.                                                          | Check the status of the virtual machine and if the configuration file is valid. |
| vm          | Error | 9            | Failed to stop virtual machine.                                 | Failed to stop virtual machine.                                                           | Check the status of the virtual machine.                                        |

| Module Type | Type  | Return Value | Message                           | Description                                                             | Solution                                                                         |
|-------------|-------|--------------|-----------------------------------|-------------------------------------------------------------------------|----------------------------------------------------------------------------------|
| vm          | Error | 10           | Failed to save virtual machine.   | Failed to temporarily stop and export the virtual machine.              | Check if the status of the virtual machine is <b>Running</b> on Hyper-V manager. |
| vm          | Error | 11           | Failed to resume virtual machine. | Failed to import and restart the virtual machine.                       | Check if <b>VM configuration file path</b> is correct.                           |
| vm          | Error | 13           | Timeout occurred.                 | It took much time to import, export, start or stop the virtual machine. | Check if the timeout value is proper.                                            |
| vm          | Error | Others       | Internal error occurred.          | Internal error occurred.                                                | Memory or OS resources may not be sufficient. Check them.                        |

## Dynamic DNS resource

| Module Type | Type  | Return Value | Message                                                  | Description                                                                       | Solution                                                                                   |
|-------------|-------|--------------|----------------------------------------------------------|-----------------------------------------------------------------------------------|--------------------------------------------------------------------------------------------|
| ddns        | Error | 1            | Parameter is invalid.                                    | The dynamic DNS resource or dynamic DNS monitoring resource parameter is invalid. | Check the cluster configuration data.                                                      |
| ddns        | Error | 2            | Group does not exist in cluster configuration data.      | Group does not exist in cluster configuration data.                               | Check the cluster configuration data.                                                      |
| ddns        | Error | 3            | Resource does not exist in cluster configuration data.   | Resource does not exist in cluster configuration data.                            | Check the cluster configuration data.                                                      |
| ddns        | Error | 4            | Failed to get the value from cluster configuration data. | Failed to get the value from cluster configuration data.                          | Check the cluster configuration data.                                                      |
| ddns        | Error | 5            | Query to DNS has failed.                                 | Query to DNS has failed.                                                          | Check the DNS server setting. Make sure that communication with the DNS server is enabled. |
| ddns        | Error | 6            | Failed to delete DNS.                                    | Failed to delete DNS.                                                             | Check the DNS server setting. Make sure that communication with the DNS server is enabled. |
| ddns        | Error | 7            | Failed to update DNS.                                    | Failed to update DNS.                                                             | Check the DNS server setting. Make sure that communication with the DNS server is enabled. |
| ddns        | Error | 8            | A reception timeout occurred.                            | A reception timeout occurred.                                                     | Memory or OS resources may not be sufficient. Check them.                                  |
| ddns        | Error | 9            | Failed to send to the DNS server.                        | Failed to send to the DNS server.                                                 | Check the DNS server setting. Make sure that communication with the DNS server is enabled. |
| ddns        | Error | 10           | Failed to receive from the DNS server.                   | Failed to receive from the DNS server.                                            | Check the DNS server setting. Make sure that                                               |

| Module Type | Type  | Return Value | Message                                   | Description                               | Solution                                                                                                                                                                                    |
|-------------|-------|--------------|-------------------------------------------|-------------------------------------------|---------------------------------------------------------------------------------------------------------------------------------------------------------------------------------------------|
|             |       |              |                                           |                                           | communication with the DNS server is enabled.                                                                                                                                               |
| ddns        | Error | 13           | DDNS control process has already started. | DDNS control process has already started. | Memory or OS resources may not be sufficient. Check them. Or, the previous activation might fail. In this case, stop the cluster and kill the DDNS control process (clpddnsp.exe) manually. |
| ddns        | Error | 14           | DDNS control process is not running.      | DDNS control process is not running.      | Check the DNS server setting. Make sure that communication with the DNS server is enabled. Or, memory or OS resources are shortage. Check them.                                             |
| ddns        | Error | 16           | Failed to start DDNS control process.     | Failed to start DDNS control process.     | Check the DNS server setting. Make sure that communication with the DNS server is enabled. Or, memory or OS resources are shortage. Check them.                                             |
| ddns        | Error | 17           | Failed to stop DDNS control process.      | Failed to stop DDNS control process.      | Check the DNS server setting. Make sure that communication with the DNS server is enabled. Or, memory or OS resources may not be sufficient. Check them.                                    |
| ddns        | Error | 18           | DDNS control process path is invalid.     | DDNS control process path is invalid.     | The executable file is damaged, or memory or OS resources are shortage. Check them.                                                                                                         |
| ddns        | Error | 99           | Internal error occurred.                  | Internal error occurred.                  | Memory or OS resources may not be sufficient. Check them.                                                                                                                                   |

## AWS elastic ip resources

| Module type | Type  | Return value | Message                                      | Description                                        | Solution                                               |
|-------------|-------|--------------|----------------------------------------------|----------------------------------------------------|--------------------------------------------------------|
| awseip      | Error | 5            | AWS CLI command failed.                      | Failed in the AWS CLI command.                     | Check if the settings in the AWS CLI file are correct. |
| awseip      | Error | 5            | The allocation ID '%1' does not exist        | The specified EIP ALLOCATION ID %1 does not exist. | Check if the value of EIP ALLOCATION ID is correct.    |
| awseip      | Error | 5            | The networkInterface ID '%1' does not exist) | The specified ENI ID %1 does not exist.            | Check if the value of ENI ID is correct.               |
| awseip      | Error | 6            | Timeout occurred.                            | Timeout occurred.                                  | Memory or OS resources may not be                      |

| Module type | Type  | Return value | Message                  | Description                 | Solution                                                                                                                                         |
|-------------|-------|--------------|--------------------------|-----------------------------|--------------------------------------------------------------------------------------------------------------------------------------------------|
|             |       |              |                          |                             | sufficient. Check them.                                                                                                                          |
| awseip      | Error | 7            | ENI ID is invalid.       | The ENI ID is invalid.      | Check if the value of ENI ID is correct.<br>Check if ENI ID of other instance is specified mistakenly.                                           |
| awseip      | Error | 99           | Internal error occurred. | An internal error occurred. | Check if Python is installed correctly.<br>Check if AWS CLI is installed correctly.<br>Memory or OS resources may not be sufficient. Check them. |

## AWS virtual ip resources

| Module type | Type  | Return value | Message                                      | Description                              | Solution                                                                                                      |
|-------------|-------|--------------|----------------------------------------------|------------------------------------------|---------------------------------------------------------------------------------------------------------------|
| awsvip      | Error | 5            | AWS CLI command failed.                      | Failed in the AWS CLI command.           | Check if the settings in the AWS CLI file are correct.                                                        |
| awsvip      | Error | 5            | The vpc ID '%1' does not exist               | The specified VPC ID %1 does not exist.  | Check if the value of VPC ID is correct.                                                                      |
| awsvip      | Error | 5            | The networkInterface ID '%1' does not exist) | The specified ENI ID %1 does not exist.  | Check if the value of ENI ID is correct.                                                                      |
| awsvip      | Error | 6            | Timeout occurred.                            | Timeout occurred.                        | Memory or OS resources may not be sufficient. Check them.                                                     |
| awsvip      | Error | 7            | The VIP address belongs to a VPC subnet.     | The VIP address belongs to a VPC subnet. | For the VIP address, an IP address not belonging to a VPC subnet must be specified.<br>Check the VIP address. |
| awsvip      | Error | 8            | Failed to add the VIP address.               | Failed to add the VIP address.           | Check the VIP settings.<br>Memory or OS resources may not be sufficient. Check them.                          |
| awsvip      | Error | 9            | Failed to delete the VIP address.            | Failed to delete the VIP address.        | Memory or OS resources may not be sufficient. Check them.                                                     |
| awsvip      | Error | 10           | The VIP address is already used.             | The VIP address is already used.         | Check if the VIP address is already used.                                                                     |
| awsvip      | Error | 11           | ENI ID is invalid.                           | The ENI ID is invalid.                   | Check if the value of ENI ID is correct.<br>Check if ENI ID of other instance is specified mistakenly.        |

| Module type | Type  | Return value | Message                              | Description                          | Solution                                                                                                                                         |
|-------------|-------|--------------|--------------------------------------|--------------------------------------|--------------------------------------------------------------------------------------------------------------------------------------------------|
| awsvip      | Error | 12           | The IP address on ENI is not static. | The IP address on ENI is not static. | The IP address on the ENI is not static.<br>Change the IP address static IP address.                                                             |
| awsvip      | Error | 99           | Internal error occurred.             | An internal error occurred.          | Check if Python is installed correctly.<br>Check if AWS CLI is installed correctly.<br>Memory or OS resources may not be sufficient. Check them. |

### Azure probe port resources

| Module type | Type  | Return value | Message                                             | Description                                         | Solution                                                                                                                                                                                                                                 |
|-------------|-------|--------------|-----------------------------------------------------|-----------------------------------------------------|------------------------------------------------------------------------------------------------------------------------------------------------------------------------------------------------------------------------------------------|
| azurepp     | Error | 5            | Probe port is already used.                         | The Probe port is already used.                     | Check if the probe port is already open on the local server.                                                                                                                                                                             |
| azurepp     | Error | 6            | Failed to open the probe port.                      | Failed to open the probe port.                      | Memory or OS resources may not be sufficient. Check them.                                                                                                                                                                                |
| azurepp     | Error | 7            | Failed to close the probe port.                     | Failed to close the probe port.                     | Memory or OS resources may not be sufficient. Check them.                                                                                                                                                                                |
| azurepp     | Error | 8            | Failed to stop the probe port control process.      | Failed to stop the probe port control process.      | Memory or OS resources may not be sufficient. Check them.<br>Reboot the OS.                                                                                                                                                              |
| azurepp     | Error | 9            | The probe port control process has already started. | The probe port control process has already started. | Memory or OS resources may not be sufficient. Check them.<br>Or, the immediately preceding deactivation may have failed. In that case, stop the cluster and forcibly terminate the probe port control process (clpazurepp.exe) manually. |
| azurepp     | Error | 10           | Failed to start the probe port control process.     | Failed to start the probe port control process.     | Memory or OS resources may not be sufficient. Check them.                                                                                                                                                                                |
| azurepp     | Error | 99           | Internal error has occurred.                        | An internal error has occurred.                     | Memory or OS resources may not be sufficient. Check them.                                                                                                                                                                                |

## Detailed information of monitor resource errors

The following information is displayed in the message recorded in event log or alert viewer as detail information when monitor resource detects an error.

### Application monitor resource

| Module Type | Type  | Return Value | Message                                 | Description                                                                     | Solution                                                                                       |
|-------------|-------|--------------|-----------------------------------------|---------------------------------------------------------------------------------|------------------------------------------------------------------------------------------------|
| appliw      | Error | 9            | Process did not exist. (Stop code : %1) | Process did not exist. (The stop code is displayed only if it can be acquired.) | Process of the monitoring target application resource was cleared due to some error. Check it. |
| appliw      | Error | 11           | Failed to log on as a user.             | Failed to log on as a user.                                                     | Check if a domain, an account and a password of the logon user are set properly.               |
| appliw      | Error | Others       | Internal error occurred.                | Internal error occurred.                                                        | Memory or OS resources may not be sufficient. Check them.                                      |

### CIFS monitor resource

| Module Type | Type  | Return Value | Message                                        | Description                                                                                     | Solution                                                                                                     |
|-------------|-------|--------------|------------------------------------------------|-------------------------------------------------------------------------------------------------|--------------------------------------------------------------------------------------------------------------|
| cifsw       | Error | 3            | Access denied.                                 | Local system account doesn't have the appropriate access right to the shared folder.            | Correct the access right setting of target folder.                                                           |
| cifsw       | Error | 6            | Insufficient memory is available.              | Insufficient memory is available.                                                               | Memory or OS resources may not be sufficient. Check them.                                                    |
| cifsw       | Error | 8            | The specified share name can not be found.     | The specified share name can not be found.                                                      | Check if the setting of file sharing has been canceled.                                                      |
| cifsw       | Error | 13           | Error occurred while doing file check.         | Error occurred while doing file check.                                                          | Check if local system account has the appropriate access right for executing specified method of monitoring. |
| cifsw       | Error | 14           | Error occurred while doing folder check.       | Error occurred while doing folder check.                                                        | Check if local system account has the appropriate access right for executing specified method of monitoring. |
| cifsw       | Error | 19           | Failed to check the shared configuration file. | Failed to execute checking the configuration data saved in the shared configuration file.       | Check if the shared configuration file is corrupted.                                                         |
| cifsw       | Error | 21           | CIFS control process does not exist.           | Failed to start up the process (clpcifsp.exe) that monitors the change of shared configuration. | Activate CIFS resource again.                                                                                |

| Module Type | Type    | Return Value | Message                   | Description                               | Solution                                                                               |
|-------------|---------|--------------|---------------------------|-------------------------------------------|----------------------------------------------------------------------------------------|
| cifsw       | Error   | 99           | Internal error occurred.  | Internal error occurred.                  | Memory or OS resources may not be sufficient. Check them.                              |
| cifsw       | Warning | 101          | Setting has been changed. | Setting of file sharing has been changed. | Check if the user limit setting or the target folder of file sharing has been changed. |

## DB2 monitor resource

| Module Type | Type  | Return Value | Message                                                | Description                                                                                                                                 | Solution                                                                                                                         |
|-------------|-------|--------------|--------------------------------------------------------|---------------------------------------------------------------------------------------------------------------------------------------------|----------------------------------------------------------------------------------------------------------------------------------|
| db2w        | Error | 1            | Initialization has failed[%1].                         | Initialization process has failed. It may be due to memory allocation failure.<br>Information on the initialization may be displayed on %1. | OS itself may have errors.<br>Restart the server or take other actions.                                                          |
| db2w        | Error | 2            | The configured value is not correct.                   | The configured value of the monitoring is not correct.                                                                                      | Check the configured value on the Builder because they may not be correct.                                                       |
| db2w        | Error | 10           | A function error was detected.                         | A function error occurred.                                                                                                                  | Monitor applications or OS may have errors. Check the status of the system.                                                      |
| db2w        | Error | 11           | An error was detected in accessing the monitor target. | Accessing the database failed.                                                                                                              | Check configured values on the Builder (such as a database name). If there is no error, check the database has errors.           |
| db2w        | Error | 12           | An error was detected in user authentication.          | Accessing the database failed.                                                                                                              | Check configured values on the Builder (such as a user name or a password). If there is no error, check the database has errors. |
| db2w        | Error | 13           | An application error was detected.                     | A database error was detected.                                                                                                              | Refer to error messages for database described separately to fix errors.                                                         |
| db2w        | Error | 14           | An error was detected in executing SQL statement [%1]. | Executing SQL statement failed.<br>The executed SQL statement is displayed on %1.                                                           | Refer to error messages for database described separately to fix errors.                                                         |

| Module Type | Type  | Return Value | Message                                  | Description                                    | Solution                                                                                                                                                                                                                                                              |
|-------------|-------|--------------|------------------------------------------|------------------------------------------------|-----------------------------------------------------------------------------------------------------------------------------------------------------------------------------------------------------------------------------------------------------------------------|
| db2w        | Error | 15           | A data error was detected.               | A value on the table of database has an error. | Database may be corrupt. Stop the database operation and investigate it. This error may occur when more than one monitoring is performed with the same monitor table name concurrently. Check if the values set in the multi-directional environment are appropriate. |
| db2w        | Error | 40           | No license is registered.                | The license has not been registered.           | Register the license.                                                                                                                                                                                                                                                 |
| db2w        | Error | 60           | Failed to obtain the configuration data. | The configured value could not be obtained.    | OS may have errors. Restart the server or take other actions.                                                                                                                                                                                                         |
| db2w        | Error | 98           | Internal error.                          | Internal error occurred.                       | Memory or OS resources may not be sufficient. Check them.                                                                                                                                                                                                             |

### Disk RW monitor resource

| Module Type | Type  | Return Value | Message                                                             | Description                                                         | Solution                                                                                                                                                                                                                         |
|-------------|-------|--------------|---------------------------------------------------------------------|---------------------------------------------------------------------|----------------------------------------------------------------------------------------------------------------------------------------------------------------------------------------------------------------------------------|
| diskw       | Error | 1            | Initialization error has occurred in internal resource.             | Initialization error has occurred in internal resource.             | Memory or OS resources may not be sufficient. Check them.                                                                                                                                                                        |
| diskw       | Error | 2            | Failed to add keep alive drive when initializing keep alive driver. | Failed to add keep alive drive when initializing keep alive driver. | Memory or OS resources may not be sufficient. Check them.                                                                                                                                                                        |
| diskw       | Error | 3            | Initialization has not been done.                                   | Initialization has not been done.                                   | Memory or OS resources may not be sufficient. Check them.                                                                                                                                                                        |
| diskw       | Error | 4            | Failed to obtain the cluster configuration data.                    | Failed to obtain the cluster configuration data.                    | The cluster configuration data is invalid. Check the disk RW monitor resource on the Builder.                                                                                                                                    |
| diskw       | Error | 5            | Failed to open the file.                                            | Failed to open the file.                                            | Check if the disk driver of the monitoring target disk is loaded, the disk is connected properly, the disk is powered on, or no other errors are occurred on the disk. Memory or OS resources may not be sufficient. Check them. |



| Module Type | Type  | Return Value | Message                                                    | Description                                                | Solution                                                                                                                                                                                                                        |
|-------------|-------|--------------|------------------------------------------------------------|------------------------------------------------------------|---------------------------------------------------------------------------------------------------------------------------------------------------------------------------------------------------------------------------------|
| diskw       | Error | 6            | Failed to write in the file.                               | Failed to write in the file.                               | Check if the monitoring target disk is connected properly, the disk is powered on, or no other errors are occurred on the disk. Memory or OS resources may not be sufficient. Check them.                                       |
| diskw       | Error | 7            | Failed to synchronize the disk of the file.                | Failed to synchronize the disk of the file.                | Check if the monitoring target disk is connected properly, the disk is powered on, or no other errors are occurred on the disk. Memory or OS resources may not be sufficient. Check them.                                       |
| diskw       | Error | 8            | Failed to close the file.                                  | Failed to close the file.                                  | Check if the monitoring target disk is connected properly, the disk is powered on, or no other errors are occurred on the disk. Memory or OS resources may not be sufficient. Check them.                                       |
| diskw       | Error | 9            | Timeout has occurred when initializing internal resources. | Timeout has occurred when initializing internal resources. | Check if an error is occurred on the monitoring target disk. If there is no error, memory or OS resources may not be sufficient. Check them.                                                                                    |
| diskw       | Error | 10           | Failed to allocate memory.                                 | Failed to allocate memory.                                 | Memory or OS resources may not be sufficient. Check them.                                                                                                                                                                       |
| diskw       | Error | 70           | Timeout has occurred when initializing internal resources. | Timeout has occurred when initializing internal resources. | Memory or OS resources may not be sufficient. Check them.                                                                                                                                                                       |
| diskw       | Error | 71           | Timeout has occurred when opening the file.                | Timeout has occurred when opening the file.                | Check if the monitoring target disk is connected properly, the disk is powered on, or no other errors are occurred on the disk. The system may be under high load, or memory or OS resources may not be sufficient. Check them. |
| diskw       | Error | 72           | Timeout has occurred when writing in the file.             | Timeout has occurred when writing in the file.             | Check if the monitoring target disk is connected properly, the disk is powered on, or no other errors are occurred on the disk. The system may be under high load, or memory or OS resources may not be sufficient. Check them. |

| Module Type | Type  | Return Value | Message                                                       | Description                                                   | Solution                                                                                                                                                                                                                        |
|-------------|-------|--------------|---------------------------------------------------------------|---------------------------------------------------------------|---------------------------------------------------------------------------------------------------------------------------------------------------------------------------------------------------------------------------------|
| diskw       | Error | 73           | Timeout has occurred when synchronizing the disk of the file. | Timeout has occurred when synchronizing the disk of the file. | Check if the monitoring target disk is connected properly, the disk is powered on, or no other errors are occurred on the disk. The system may be under high load, or memory or OS resources may not be sufficient. Check them. |
| diskw       | Error | 74           | Timeout has occurred when closing the file.                   | Timeout has occurred when closing the file.                   | Check if the monitoring target disk is connected properly, the disk is powered on, or no other errors are occurred on the disk. The system may be under high load, or memory or OS resources may not be sufficient. Check them. |
| diskw       | Error | 90           | Internal error occurred.                                      | Internal error occurred.                                      | Check if the monitoring target disk is connected properly, the disk is powered on, or no other errors are occurred on the disk. The system may be under high load, or memory or OS resources may not be sufficient. Check them. |
| diskw       | Error | 99           | Internal error occurred.                                      | Internal error occurred.                                      | Memory or OS resources may not be sufficient. Check them.                                                                                                                                                                       |

### Floating IP monitor resource

| Module Type | Type  | Return Value | Message                            | Description                        | Solution                                                                             |
|-------------|-------|--------------|------------------------------------|------------------------------------|--------------------------------------------------------------------------------------|
| fipw        | Error | 6            | IP address does not exist.         | IP address does not exist.         | NIC may have been disabled. Check if the FIP address exists by the ipconfig command. |
| fipw        | Error | 11           | Adapter Index is different.        | Adapter Index is different.        | NIC may have been disabled. Check if the FIP address exists by the ipconfig command. |
| fipw        | Error | 12           | Failed to obtain IP address table. | Failed to obtain IP address table. | Memory or OS resources may not be sufficient. Check them.                            |
| fipw        | Error | 13           | Failed to get NIC interface name.  | Failed to get NIC interface name.  | Memory or OS resources may not be sufficient. Check them.                            |
| fipw        | Error | 14           | Failed to get NIC status.          | Failed to get NIC status.          | Check if the NIC device is supported by the device I/O controller.                   |

| Module Type | Type  | Return Value | Message                  | Description              | Solution                                                  |
|-------------|-------|--------------|--------------------------|--------------------------|-----------------------------------------------------------|
| fipw        | Error | 15           | Detected NIC Link Down.  | Detected NIC Link Down.  | Check if the LAN cable is connected properly.             |
| fipw        | Error | Others       | Internal error occurred. | Internal error occurred. | Memory or OS resources may not be sufficient. Check them. |

## FTP monitor resource

| Module Type | Type  | Return Value | Message                                                | Description                                                                                                                                 | Solution                                                                                                                                      |
|-------------|-------|--------------|--------------------------------------------------------|---------------------------------------------------------------------------------------------------------------------------------------------|-----------------------------------------------------------------------------------------------------------------------------------------------|
| ftpw        | Error | 1            | Initialization has failed[%1].                         | Initialization process has failed. It may be due to memory allocation failure.<br>Information on the initialization may be displayed on %1. | OS itself may have errors. Restart the server or take other actions                                                                           |
| ftpw        | Error | 2            | The configured value is not correct.                   | The configured value of the monitoring is not correct.                                                                                      | Check the configured value on the Builder because it may not be correct.                                                                      |
| ftpw        | Error | 10           | A function error was detected.                         | A function error occurred.                                                                                                                  | Monitor applications or OS may have errors. Check the status of the system.                                                                   |
| ftpw        | Error | 11           | An error was detected in accessing the monitor target. | The access to the monitor application failed.                                                                                               | Check configured values on the Builder (such as an IP address). If there is no error, check if the monitor application has errors.            |
| ftpw        | Error | 12           | An error was detected in user authentication.          | The user authentication failed.                                                                                                             | Check configured values on the Builder (such as a user name or a password). If there is no error, check if the monitor application has errors |
| ftpw        | Error | 13           | An application error was detected.                     | A monitor application error was detected.                                                                                                   | Refer to error messages for monitor applications described separately to fix errors.                                                          |
| ftpw        | Error | 15           | A data error was detected.                             | A value of the response data has an error.                                                                                                  | Refer to error messages for monitor applications described separately to fix errors.                                                          |
| ftpw        | Error | 40           | No license is registered.                              | The license has not been registered.                                                                                                        | Register the license.                                                                                                                         |
| ftpw        | Error | 60           | Failed to obtain the configuration data.               | The configured value could not be obtained.                                                                                                 | OS may have errors. Restart the server or take other actions                                                                                  |

| Module Type | Type  | Return Value | Message         | Description              | Solution                                                  |
|-------------|-------|--------------|-----------------|--------------------------|-----------------------------------------------------------|
| ftpw        | Error | 98           | Internal error. | Internal error occurred. | Memory or OS resources may not be sufficient. Check them. |

## Custom monitor resource

| Module Type | Type  | Return Value | Message                                                  | Description                                                              | Solution                                                  |
|-------------|-------|--------------|----------------------------------------------------------|--------------------------------------------------------------------------|-----------------------------------------------------------|
| genw        | Error | 1            | Parameter is invalid.                                    | The configured value of the monitoring is not correct.                   | Check the configured value on the Builder.                |
| genw        | Error | 2            | Resource does not exist in cluster configuration data.   | The cluster configuration data is not correct.                           | Check the cluster configuration data on the Builder.      |
| genw        | Error | 3            | Failed to get the value from cluster configuration data. | The cluster configuration data is not correct.                           | Check the cluster configuration data on the Builder.      |
| genw        | Error | 4            | Script path is invalid.                                  | The configured value of the script path is not correct.                  | Check the configured value on the Builder.                |
| genw        | Error | 5            | Failed to start script.                                  | Failed to start script.                                                  | Check if the script can be executed.                      |
| genw        | Error | 6            | Script did not exist.                                    | The asynchronous type script terminated abnormally.                      | Check the cause of the termination of the script.         |
| genw        | Error | 7            | Timeout occurred.                                        | The synchronous type script did not terminate within the timeout period. | Check the cause of the delay of the script.               |
| genw        | Error | 8            | Returned exit code %1.                                   | The synchronous type script returned abnormal error code.                | Check the cause for the abnormal error code.              |
| genw        | Error | 99           | Internal error occurred.                                 | Internal error occurred.                                                 | Memory or OS resources may not be sufficient. Check them. |

## Hybrid disk TUR monitor resource

| Module Type | Type  | Return Value | Message                                                                              | Description                                                                          | Solution                                                                                      |
|-------------|-------|--------------|--------------------------------------------------------------------------------------|--------------------------------------------------------------------------------------|-----------------------------------------------------------------------------------------------|
| hdtw        | Error | 1            | Initialization has failed. Check the cluster configuration data or system resources. | Initialization has failed. Check the cluster configuration data or system resources. | Memory or OS resources may not be sufficient. Check them.                                     |
| hdtw        | Error | 2            | Initialization has not been done.                                                    | Initialization has not been done.                                                    | Memory or OS resources may not be sufficient. Check them.                                     |
| hdtw        | Error | 3            | The cluster configuration data is invalid.                                           | The cluster configuration data is invalid.                                           | The cluster configuration data is invalid. Check the disk TUR monitor resource on the Builder |

## Detailed information of monitor resource errors

| Module Type | Type  | Return Value | Message                                                                                         | Description                                                                                     | Solution                                                                                                                                                                                                                                            |
|-------------|-------|--------------|-------------------------------------------------------------------------------------------------|-------------------------------------------------------------------------------------------------|-----------------------------------------------------------------------------------------------------------------------------------------------------------------------------------------------------------------------------------------------------|
| Hdtw        | Error | 4            | Failed to open device. Check the disk status of monitor destination volume.                     | Failed to open device. Check the disk status of monitor destination volume.                     | Check if the disk driver of the monitoring target disk is loaded, the device exists, the disk is connected properly, the disk is powered on, or no other errors are occurred on the disk. Memory or OS resources may not be sufficient. Check them. |
| hdtw        | Error | 5            | Failed to control device. Check the disk status of monitor destination volume.                  | Failed to control device. Check the disk status of monitor destination volume.                  | Check if the monitoring target disk is connected properly, the disk is powered on, or no other errors are occurred on the disk.                                                                                                                     |
| hdtw        | Error | 6            | Internal resources are busy.                                                                    | Internal resources are busy.                                                                    | Memory or OS resources may not be sufficient. Check them.                                                                                                                                                                                           |
| hdtw        | Error | 7            | Failed to allocate memory. Check the system resource.                                           | Failed to allocate memory. Check the system resource.                                           | Memory or OS resources may not be sufficient. Check them.                                                                                                                                                                                           |
| hdtw        | Error | 90           | Polling timeout. Check the disk load of the monitor target and extend the monitor timeout time. | Polling timeout. Check the disk load of the monitor target and extend the monitor timeout time. | Check if the monitoring target disk is connected properly, the disk is powered on, or no other errors are occurred on the disk. The system may be under high load, or memory or OS resources may not be sufficient. Check them.                     |
| hdtw        | Error | 99           | Other internal error has occurred. Check the system resource.                                   | Other internal error has occurred. Check the system resource.                                   | Memory or OS resources may not be sufficient. Check them.                                                                                                                                                                                           |

## Hybrid disk monitor resource

| Module Type | Type    | Return Value | Message                                           | Description                                                               | Solution                                                                                                    |
|-------------|---------|--------------|---------------------------------------------------|---------------------------------------------------------------------------|-------------------------------------------------------------------------------------------------------------|
| hdw         | Error   | 2            | Internal error.                                   | An internal error has occurred.                                           | Memory or OS resources may not be sufficient. Check them.                                                   |
| hdw         | Error   | 3            | HDR %1 has old data.                              | The information in the activated hybrid disk %1 is not updated.           | Check the status of the hybrid disk with Mirror Disk Helper.                                                |
| hdw         | Error   | 4            | A disk error is detected in HDR %1.               | A disk error has been detected in hybrid disk %1.                         | Make sure there is no HW failure in the disk or disk path where cluster partition or data partition exists. |
| hdw         | Error   | 5            | The status of HDR %1 is invalid.                  | The status of the hybrid disk %1 is invalid.                              | Restart the cluster.                                                                                        |
| hdw         | Warning | 101          | HDR %1 recovery is in progress.                   | Hybrid disk %1 is being copied.                                           | Wait for a while until mirror recovery completes.                                                           |
| hdw         | Warning | 102          | HDR %1 is not being mirrored.                     | Hybrid disk %1 has not been mirrored.                                     | Check the status of the hybrid disk with Mirror Disk Helper.                                                |
| hdw         | Warning | 103          | HDR %1 is activated on more than one server.      | Hybrid disk %1 is activated on both server groups.                        | Deactivate the hybrid disk on one of the server groups.                                                     |
| hdw         | Warning | 104          | The status of HDR %1 is unknown.                  | Hybrid disk to be monitored is stopped.                                   | Stop the monitor resource or start the hybrid disk to be monitored.                                         |
| hdw         | Warning | 105          | Whether HDR %1 data is old/new is not determined. | Whether the data in hybrid disk %1 is old or new has not been determined. | Activate the hybrid disk on one of the servers.                                                             |

## HTTP monitor resource

| Module Type | Type  | Return Value | Message                              | Description                                                                                                                                 | Solution                                                                    |
|-------------|-------|--------------|--------------------------------------|---------------------------------------------------------------------------------------------------------------------------------------------|-----------------------------------------------------------------------------|
| httpw       | Error | 1            | Initialization has failed[%1].       | Initialization process has failed. It may be due to memory allocation failure.<br>Information on the initialization may be displayed on %1. | OS itself may have errors. Restart the server or take other actions.        |
| httpw       | Error | 2            | The configured value is not correct. | The configured value of the monitoring is not correct.                                                                                      | Check the configured value on the Builder because it may not be correct.    |
| httpw       | Error | 10           | A function error was detected.       | A function error occurred.                                                                                                                  | Monitor applications or OS may have errors. Check the status of the system. |

| Module Type | Type  | Return Value | Message                                                | Description                                   | Solution                                                                                                                           |
|-------------|-------|--------------|--------------------------------------------------------|-----------------------------------------------|------------------------------------------------------------------------------------------------------------------------------------|
| httpw       | Error | 11           | An error was detected in accessing the monitor target. | The access to the monitor application failed. | Check configured values on the Builder (such as an IP address). If there is no error, check if the monitor application has errors. |
| httpw       | Error | 13           | An application error was detected.                     | A monitor application error was detected.     | Refer to error messages for monitor applications described separately to fix errors.                                               |
| httpw       | Error | 15           | A data error was detected.                             | A value of the response data has an error.    | Refer to error messages for monitor applications described separately to fix errors.                                               |
| httpw       | Error | 40           | No license is registered.                              | The license has not been registered.          | Register the license.                                                                                                              |
| httpw       | Error | 60           | Failed to obtain the configuration data.               | The configured value could not be obtained.   | OS may have errors. Restart the server or take other actions.                                                                      |
| httpw       | Error | 98           | Internal error.                                        | Internal error occurred.                      | Memory or OS resources may not be sufficient. Check them.                                                                          |

## IMAP4 monitor resource

| Module Type | Type  | Return Value | Message                                                | Description                                                                                                                                 | Solution                                                                                                                           |
|-------------|-------|--------------|--------------------------------------------------------|---------------------------------------------------------------------------------------------------------------------------------------------|------------------------------------------------------------------------------------------------------------------------------------|
| imap4w      | Error | 1            | Initialization has failed[%1].                         | Initialization process has failed. It may be due to memory allocation failure.<br>Information on the initialization may be displayed on %1. | OS itself may have errors. Restart the server or take other actions                                                                |
| imap4w      | Error | 2            | The configured value is not correct.                   | The configured value of the monitoring is not correct.                                                                                      | Check the configured value on the Builder because it may not be correct.                                                           |
| imap4w      | Error | 10           | A function error was detected.                         | A function error occurred.                                                                                                                  | Monitor applications or OS may have errors. Check the status of the system.                                                        |
| imap4w      | Error | 11           | An error was detected in accessing the monitor target. | The access to the monitor application failed.                                                                                               | Check configured values on the Builder (such as an IP address). If there is no error, check if the monitor application has errors. |

| Module Type | Type  | Return Value | Message                                       | Description                                   | Solution                                                                                                                                       |
|-------------|-------|--------------|-----------------------------------------------|-----------------------------------------------|------------------------------------------------------------------------------------------------------------------------------------------------|
| imap4w      | Error | 12           | An error was detected in user authentication. | The access to the monitor application failed. | Check configured values on the Builder (such as a user name or a password). If there is no error, check if the monitor application has errors. |
| imap4w      | Error | 13           | An application error was detected.            | A monitor application error was detected.     | Refer to error messages for monitor applications described separately to fix errors.                                                           |
| imap4w      | Error | 15           | A data error was detected.                    | A value of the response data has an error.    | Refer to error messages for monitor applications described separately to fix errors.                                                           |
| imap4w      | Error | 40           | No license is registered.                     | The license has not been registered.          | Register the license.                                                                                                                          |
| imap4w      | Error | 60           | Failed to obtain the configuration data.      | The configured value could not be obtained.   | OS may have errors. Restart the server or take other actions.                                                                                  |
| imap4w      | Error | 98           | Internal error.                               | Internal error occurred.                      | Memory or OS resources may not be sufficient. Check them.                                                                                      |

## IP monitor resource

| Module Type | Type  | Return Value | Message                  | Description              | Solution                                                                                                                                                                      |
|-------------|-------|--------------|--------------------------|--------------------------|-------------------------------------------------------------------------------------------------------------------------------------------------------------------------------|
| ipw         | Error | 4            | Ping could not reach.    | Ping could not reach.    | Check if the ping command to the corresponding IP address succeeds. When the command fails, check the status of the device that has the IP address and the network interface. |
| ipw         | Error | 5            | Timeout occurred.        | Timeout occurred.        | Memory or OS resources may not be sufficient. Check them.                                                                                                                     |
| ipw         | Error | Others       | Internal error occurred. | Internal error occurred. | Memory or OS resources may not be sufficient. Check them.                                                                                                                     |

## Mirror disk monitor resource

| Module Type | Type  | Return Value | Message         | Description     | Solution                                                  |
|-------------|-------|--------------|-----------------|-----------------|-----------------------------------------------------------|
| mdw         | Error | 2            | Internal error. | Internal error. | Memory or OS resources may not be sufficient. Check them. |



| Module Type | Type    | Return Value | Message                                              | Description                                          | Solution                                                                                                                             |
|-------------|---------|--------------|------------------------------------------------------|------------------------------------------------------|--------------------------------------------------------------------------------------------------------------------------------------|
| mdw         | Error   | 3            | Mirror disk %1 is abnormal.                          | Mirror disk %1 is abnormal.                          | The mirror disk of the local server has errors. Check it on the mirror disk helper.                                                  |
| mdw         | Warning | 101          | Mirror disk %1 recovery is in progress.              | Mirror disk %1 recovery is in progress.              | Wait for a while until the mirror recovery completes.                                                                                |
| mdw         | Warning | 102          | Mirror disk %1 is not being mirrored.                | Mirror disk %1 is not being mirrored.                | Check the mirror disk on the mirror disk helper.                                                                                     |
| mdw         | Warning | 103          | Mirror disk %1 is uncertain status.                  | Mirror disk %1 is uncertain status.                  | Check the mirror disk on the mirror disk helper.                                                                                     |
| mdw         | Warning | 104          | Mirror disk %1 is activated on more than one server. | Mirror disk %1 is activated on more than one server. | When activation of the mirror disk resources on both servers is detected, the server is automatically shut down. Restart the server. |
| mdw         | Warning | 105          | Mirror disk %1 is unknown status.                    | Mirror disk %1 is unknown status.                    | Memory or OS resources may not be sufficient. Check them.                                                                            |

### Mirror connect monitor resource

| Module Type | Type    | Return Value | Message                         | Description                     | Solution                                                  |
|-------------|---------|--------------|---------------------------------|---------------------------------|-----------------------------------------------------------|
| mdnw        | Error   | 2            | An internal error has occurred. | An internal error has occurred. | Memory or OS resources may not be sufficient. Check them. |
| mdnw        | Warning | 100          | Network was interrupted.        | Network was interrupted.        | Check the connection status of the mirror connect.        |

### NIC Link Up/Down monitor resource

| Module Type | Type  | Return Value | Message                           | Description                       | Solution                                                                                                 |
|-------------|-------|--------------|-----------------------------------|-----------------------------------|----------------------------------------------------------------------------------------------------------|
| miiw        | Error | 4            | IP address does not exist.        | IP address does not exist.        | NIC may have been disabled. Check if the IP address of the specified NIC exists by the ipconfig command. |
| miiw        | Error | 5            | Failed to get IP address table.   | Failed to get IP address table.   | Memory or OS resources may not be sufficient. Check them.                                                |
| miiw        | Error | 6            | Failed to get NIC interface name. | Failed to get NIC interface name. | Memory or OS resources may not be sufficient. Check them.                                                |

| Module Type | Type  | Return Value | Message                         | Description                     | Solution                                                           |
|-------------|-------|--------------|---------------------------------|---------------------------------|--------------------------------------------------------------------|
| miiw        | Error | 7            | Failed to get NIC status.       | Failed to get NIC status.       | Check if the NIC device is supported by the device I/O controller. |
| miiw        | Error | 8            | Detected NIC Link Down.         | Detected NIC Link Down.         | Check if the LAN cable is connected properly.                      |
| miiw        | Error | Others       | An internal error has occurred. | An internal error has occurred. | Memory or OS resources may not be sufficient. Check them.          |

### Multi target monitor resource

| Module Type | Type  | Return Value | Message                                | Description                            | Solution                                                                        |
|-------------|-------|--------------|----------------------------------------|----------------------------------------|---------------------------------------------------------------------------------|
| mtw         | Error | Other        | Internal error occurred.(status:%1!d!) | Internal error occurred.(status:%1!d!) | Memory or OS resources may not be sufficient. Check them.                       |
| mtw         | Error | 5            | Status of resources is abnormal.       | Status of resources is abnormal.       | Check the status of the monitor resources listed on the monitor resources list. |
| mtw         | Error | 1            | This option is invalid.                | This option is invalid.                | Memory or OS resources may not be sufficient. Check them.                       |

### NAS monitor resource

| Module Type | Type  | Return Value | Message                                                                             | Description                                                             | Solution                                                    |
|-------------|-------|--------------|-------------------------------------------------------------------------------------|-------------------------------------------------------------------------|-------------------------------------------------------------|
| nasw        | Error | 3            | Invalid nas drive. drv:%1                                                           | The target drive is not the network drive.                              | Check if the drive letters have been changed                |
| nasw        | Error | 4            | Failed to get the network resource mapped by the specified drive. drv:%1 errcode:%2 | The target drive is not being mounted.                                  | Check if the network drive has been unmounted.              |
| nasw        | Error | 4            | The network resource is not connected. path:%1                                      | The target drive is not being mounted.                                  | Check if the network drive has been unmounted.              |
| nasw        | Error | 4            | The network resource is different from that of the configuration value. drv:%1      | The network resource is different from that of the configuration value. | Check if the setting of the network drive has been changed. |
| nasw        | Error | 99           | An internal error has occurred.                                                     | An internal error has occurred.                                         | Memory or OS resources may not be sufficient. Check them.   |

### Process name monitor resource

| Module Type | Type  | Return Value | Message               | Description                             | Solution                                                      |
|-------------|-------|--------------|-----------------------|-----------------------------------------|---------------------------------------------------------------|
| psw         | Error | 1            | Parameter is invalid. | The monitor setting value is incorrect. | The setting value for the Builder may be incorrect. Check it. |

| Module Type | Type  | Return Value | Message                                                                                                           | Description                                                                               | Solution                                                                                     |
|-------------|-------|--------------|-------------------------------------------------------------------------------------------------------------------|-------------------------------------------------------------------------------------------|----------------------------------------------------------------------------------------------|
| psw         | Error | 4            | Process [%1!s!, pid=%2!d!] down.                                                                                  | Loss of the process to be monitored has been detected.                                    | Check whether the process to be monitored is running properly.                               |
| psw         | Error | 5            | The number of processes to be monitored is less than the minimum process count. Process count %1!d!/%2!d! (%3!s!) | The number of running processes to be monitored does not reach the specified lower limit. | Check whether the process to be monitored is running properly.                               |
| psw         | Error | 99           | Internal error occurred.                                                                                          | An internal error has occurred.                                                           | Check the following possible causes: memory shortage or OS resource insufficiency. Check it. |

### ODBC monitor resource

| Module Type | Type  | Return Value | Message                                                | Description                                                                                                                                 | Solution                                                                                                                            |
|-------------|-------|--------------|--------------------------------------------------------|---------------------------------------------------------------------------------------------------------------------------------------------|-------------------------------------------------------------------------------------------------------------------------------------|
| odbcw       | Error | 1            | Initialization has failed[%1].                         | Initialization process has failed. It may be due to memory allocation failure.<br>Information on the initialization may be displayed on %1. | OS itself may have errors. Restart the server or take other actions.                                                                |
| odbcw       | Error | 2            | The configured value is not correct.                   | The configured value of the monitoring is not correct.                                                                                      | Check the configured value on the Builder because it may not be correct.                                                            |
| odbcw       | Error | 10           | A function error was detected.                         | A function error occurred.                                                                                                                  | Monitor applications or OS may have errors. Check the status of the system.                                                         |
| odbcw       | Error | 11           | An error was detected in accessing the monitor target. | The access to the database failed.                                                                                                          | Check configured values on the Builder (such as a database name). If there is no error, check the database has errors.              |
| odbcw       | Error | 12           | An error was detected in user authentication.          | The access to the database failed.                                                                                                          | Check configured values on the Builder (such as a user name or a password). If there is no error, check if the database has errors. |
| odbcw       | Error | 13           | An application error was detected.                     | The database error was detected.                                                                                                            | Refer to error messages for database described separately to fix errors.                                                            |
| odbcw       | Error | 14           | An error was detected in executing SQL statement [%1]. | Executing SQL statement failed.<br>The executed SQL statement is displayed on %1.                                                           | Refer to error messages for database described separately to fix errors.                                                            |

| Module Type | Type  | Return Value | Message                                  | Description                                    | Solution                                                                                                                                                                                                                                                              |
|-------------|-------|--------------|------------------------------------------|------------------------------------------------|-----------------------------------------------------------------------------------------------------------------------------------------------------------------------------------------------------------------------------------------------------------------------|
| odbcw       | Error | 15           | A data error was detected.               | A value on the table of database has an error. | Database may be corrupt. Stop the database operation and investigate it. This error may occur when more than one monitoring is performed with the same monitor table name concurrently. Check if the values set in the multi-directional environment are appropriate. |
| odbcw       | Error | 40           | No license is registered.                | The license has not been registered.           | Register the license.                                                                                                                                                                                                                                                 |
| odbcw       | Error | 60           | Failed to obtain the configuration data. | The configured value could not be obtained.    | OS may have errors. Restart the server or take other actions                                                                                                                                                                                                          |
| odbcw       | Error | 98           | Internal error.                          | Internal error occurred.                       | Memory or OS resources may not be sufficient. Check them.                                                                                                                                                                                                             |

## Oracle monitor resource

| Module Type | Type  | Return Value | Message                                                | Description                                                                                                                                 | Solution                                                                                                                            |
|-------------|-------|--------------|--------------------------------------------------------|---------------------------------------------------------------------------------------------------------------------------------------------|-------------------------------------------------------------------------------------------------------------------------------------|
| oraclew     | Error | 1            | Initialization has failed[%1].                         | Initialization process has failed. It may be due to memory allocation failure.<br>Information on the initialization may be displayed on %1. | OS itself may have errors. Restart the server or take other actions                                                                 |
| oraclew     | Error | 2            | The configured value is not correct.                   | The configured value of the monitoring is not correct.                                                                                      | Check the configured value on the Builder because it may not be correct.                                                            |
| oraclew     | Error | 10           | A function error was detected.                         | A function error occurred.                                                                                                                  | Monitor applications or OS may have errors. Check the status of the system.                                                         |
| oraclew     | Error | 11           | An error was detected in accessing the monitor target. | The access to the database failed.                                                                                                          | Check configured values on the Builder (such as a database name). If there is no error, check the database has errors.              |
| oraclew     | Error | 12           | An error was detected in user authentication.          | The access to the database failed.                                                                                                          | Check configured values on the Builder (such as a user name or a password). If there is no error, check if the database has errors. |

| Module Type | Type  | Return Value | Message                                                | Description                                                                       | Solution                                                                                                                                                                                                                                                              |
|-------------|-------|--------------|--------------------------------------------------------|-----------------------------------------------------------------------------------|-----------------------------------------------------------------------------------------------------------------------------------------------------------------------------------------------------------------------------------------------------------------------|
| oraclew     | Error | 13           | An application error was detected.                     | The database error was detected.                                                  | Refer to error messages for database described separately to fix errors.                                                                                                                                                                                              |
| oraclew     | Error | 14           | An error was detected in executing SQL statement [%1]. | Executing SQL statement failed.<br>The executed SQL statement is displayed on %1. | Refer to error messages for database described separately to fix errors.                                                                                                                                                                                              |
| oraclew     | Error | 15           | A data error was detected.                             | A value on the table of database has an error.                                    | Database may be corrupt. Stop the database operation and investigate it. This error may occur when more than one monitoring is performed with the same monitor table name concurrently. Check if the values set in the multi-directional environment are appropriate. |
| oraclew     | Error | 40           | No license is registered.                              | The license has not been registered.                                              | Register the license.                                                                                                                                                                                                                                                 |
| oraclew     | Error | 60           | Failed to obtain the configuration data.               | The configured value could not be obtained.                                       | OS may have errors. Restart the server or take other actions.                                                                                                                                                                                                         |
| oraclew     | Error | 98           | Internal error.                                        | Internal error occurred.                                                          | Memory or OS resources may not be sufficient. Check them.                                                                                                                                                                                                             |

## OracleAS monitor resource

| Module Type | Type  | Return Value | Message                                                | Description                                                                                                                                 | Solution                                                                    |
|-------------|-------|--------------|--------------------------------------------------------|---------------------------------------------------------------------------------------------------------------------------------------------|-----------------------------------------------------------------------------|
| oracleasw   | Error | 1            | Initialization has failed[%1].                         | Initialization process has failed. It may be due to memory allocation failure.<br>Information on the initialization may be displayed on %1. | OS itself may have errors. Restart the server or take other actions.        |
| oracleasw   | Error | 2            | The configured value is not correct.                   | The configured value of the monitoring is not correct.                                                                                      | Check the configured value on the Builder because it may not be correct.    |
| oracleasw   | Error | 10           | A function error was detected.                         | A function error occurred.                                                                                                                  | Monitor applications or OS may have errors. Check the status of the system. |
| oracleasw   | Error | 11           | An error was detected in accessing the monitor target. | The access to the monitor application failed.                                                                                               | Check if the monitor application has errors.                                |

| Module Type | Type  | Return Value | Message                                  | Description                                 | Solution                                                                                                                                                                      |
|-------------|-------|--------------|------------------------------------------|---------------------------------------------|-------------------------------------------------------------------------------------------------------------------------------------------------------------------------------|
| oracleasw   | Error | 13           | An application error was detected.       | The monitor application error was detected. | Check configured values on the Builder (such as an instance name). If there is no error, refer to error messages for monitor applications described separately to fix errors. |
| oracleasw   | Error | 40           | No license is registered.                | The license has not been registered.        | Register the license.                                                                                                                                                         |
| oracleasw   | Error | 60           | Failed to obtain the configuration data. | The configured value could not be obtained. | OS may have errors. Restart the server or take other actions.                                                                                                                 |
| oracleasw   | Error | 98           | Internal error.                          | Internal error occurred.                    | Memory or OS resources may not be sufficient. Check them.                                                                                                                     |

### OfficeScan CL monitor resource

| Module Type | Type  | Return Value | Message                                                  | Description                                    | Solution                                                    |
|-------------|-------|--------------|----------------------------------------------------------|------------------------------------------------|-------------------------------------------------------------|
| oscw        | Error | 2            | Failed to get the value from cluster configuration data. | The cluster configuration data is not correct. | Check the cluster configuration data on the Builder.        |
| oscw        | Error | 10           | Failed to obtain the service control right.              | Failed to obtain the service control right.    | Check if OfficeScan Server is installed correctly.          |
| oscw        | Error | 11           | Service status is abnormal.                              | Service status is abnormal.                    | Check the status of OfficeScan NT Listener.                 |
| oscw        | Error | 12           | Failed to start service.                                 | Failed to start service.                       | Check the status of OfficeScan NT Listener.                 |
| oscw        | Error | 13           | Failed to stop service.                                  | Failed to stop service.                        | Check the status of OfficeScan NT Listener.                 |
| oscw        | Error | 50           | License is invalid or not registered.                    | License is invalid or not registered.          | Check the Anti-Virus Agent license is registered and valid. |

### OfficeScan SV monitor resource

| Module Type | Type  | Return Value | Message                              | Description                                                                                                                                 | Solution                                                             |
|-------------|-------|--------------|--------------------------------------|---------------------------------------------------------------------------------------------------------------------------------------------|----------------------------------------------------------------------|
| oss         | Error | 1            | Initialization has failed[%1].       | Initialization process has failed. It may be due to memory allocation failure.<br>Information on the initialization may be displayed on %1. | OS itself may have errors. Restart the server or take other actions. |
| oss         | Error | 2            | The configured value is not correct. | The configured value of the monitoring is not correct.                                                                                      | Check if OfficeScan Server is installed correctly.                   |

| Module Type | Type  | Return Value | Message                                                | Description                                   | Solution                                                                             |
|-------------|-------|--------------|--------------------------------------------------------|-----------------------------------------------|--------------------------------------------------------------------------------------|
| ossw        | Error | 10           | A function error was detected.                         | A function error occurred.                    | Monitor applications or OS may have errors. Check the status of the system.          |
| ossw        | Error | 11           | An error was detected in accessing the monitor target. | The access to the monitor application failed. | Check if OfficeScan Server has errors.                                               |
| ossw        | Error | 13           | An application error was detected.                     | The access to the monitor application failed. | Refer to error messages for monitor applications described separately to fix errors. |
| ossw        | Error | 15           | A data error was detected.                             | A value of the response data has an error.    | Refer to error messages for monitor applications described separately to fix errors. |
| ossw        | Error | 40           | No license is registered.                              | The license has not been registered.          | Register Anti-Virus Agent license.                                                   |
| ossw        | Error | 60           | Failed to obtain the configuration data.               | The configured value could not be obtained.   | OS may have errors. Restart the server or take other actions.                        |
| ossw        | Error | 98           | Internal error.                                        | Internal error occurred.                      | Memory or OS resources may not be sufficient. Check them.                            |

### POP3 monitor resource

| Module Type | Type  | Return Value | Message                                                | Description                                                                                                                                 | Solution                                                                                                                           |
|-------------|-------|--------------|--------------------------------------------------------|---------------------------------------------------------------------------------------------------------------------------------------------|------------------------------------------------------------------------------------------------------------------------------------|
| pop3w       | Error | 1            | Initialization has failed[%1].                         | Initialization process has failed. It may be due to memory allocation failure.<br>Information on the initialization may be displayed on %1. | OS itself may have errors. Restart the server or take other actions.                                                               |
| pop3w       | Error | 2            | The configured value is not correct.                   | The configured value of the monitoring is not correct.                                                                                      | Check the configured value on the Builder because it may not be correct.                                                           |
| pop3w       | Error | 10           | A function error was detected.                         | A function error occurred.                                                                                                                  | Monitor applications or OS may have errors. Check the status of the system.                                                        |
| pop3w       | Error | 11           | An error was detected in accessing the monitor target. | The access to the monitor application failed.                                                                                               | Check configured values on the Builder (such as an IP address). If there is no error, check if the monitor application has errors. |

| Module Type | Type  | Return Value | Message                                       | Description                                   | Solution                                                                                                                                       |
|-------------|-------|--------------|-----------------------------------------------|-----------------------------------------------|------------------------------------------------------------------------------------------------------------------------------------------------|
| pop3w       | Error | 12           | An error was detected in user authentication. | The access to the monitor application failed. | Check configured values on the Builder (such as a user name or a password). If there is no error, check if the monitor application has errors. |
| pop3w       | Error | 13           | An application error was detected.            | The monitor application error was detected.   | Refer to error messages for monitor applications described separately to fix errors.                                                           |
| pop3w       | Error | 15           | A data error was detected.                    | A value of the response data has an error.    | Refer to error messages for monitor applications described separately to fix errors.                                                           |
| pop3w       | Error | 40           | No license is registered.                     | The license has not been registered.          | Register the license.                                                                                                                          |
| pop3w       | Error | 60           | Failed to obtain the configuration data       | The configured value could not be obtained.   | OS may have errors. Restart the server or take other actions.                                                                                  |
| pop3w       | Error | 98           | Internal error.                               | Internal error occurred.                      | Memory or OS resources may not be sufficient. Check them.                                                                                      |

## PostgreSQL monitor resource

| Module Type | Type  | Return Value | Message                                                | Description                                                                                                                                 | Solution                                                                                                               |
|-------------|-------|--------------|--------------------------------------------------------|---------------------------------------------------------------------------------------------------------------------------------------------|------------------------------------------------------------------------------------------------------------------------|
| psqlw       | Error | 1            | Initialization has failed[%1].                         | Initialization process has failed. It may be due to memory allocation failure.<br>Information on the initialization may be displayed on %1. | OS itself may have errors. Restart the server or take other actions.                                                   |
| psqlw       | Error | 2            | The configured value is not correct.                   | The configured value of the monitoring is not correct.                                                                                      | Check the configured value on the Builder because it may not be correct.                                               |
| psqlw       | Error | 10           | A function error was detected.                         | A function error occurred.                                                                                                                  | Monitor applications or OS may have errors. Check the status of the system.                                            |
| psqlw       | Error | 11           | An error was detected in accessing the monitor target. | The access to the database failed.                                                                                                          | Check configured values on the Builder (such as a database name). If there is no error, check the database has errors. |



| Module Type | Type  | Return Value | Message                                                | Description                                                                       | Solution                                                                                                                                                                                                                                                              |
|-------------|-------|--------------|--------------------------------------------------------|-----------------------------------------------------------------------------------|-----------------------------------------------------------------------------------------------------------------------------------------------------------------------------------------------------------------------------------------------------------------------|
| psqlw       | Error | 12           | An error was detected in user authentication.          | The access to the database failed.                                                | Check configured values on the Builder (such as a user name or a password). If there is no error, check if the database has errors.                                                                                                                                   |
| psqlw       | Error | 13           | An application error was detected.                     | The database error was detected.                                                  | Refer to error messages for database described separately to fix errors.                                                                                                                                                                                              |
| psqlw       | Error | 14           | An error was detected in executing SQL statement [%1]. | Executing SQL statement failed.<br>The executed SQL statement is displayed on %1. | Refer to error messages for database described separately to fix errors.                                                                                                                                                                                              |
| psqlw       | Error | 15           | A data error was detected.                             | A value on the table of database has an error.                                    | Database may be corrupt. Stop the database operation and investigate it. This error may occur when more than one monitoring is performed with the same monitor table name concurrently. Check if the values set in the multi-directional environment are appropriate. |
| psqlw       | Error | 40           | No license is registered.                              | The license has not been registered.                                              | Register the license.                                                                                                                                                                                                                                                 |
| psqlw       | Error | 60           | Failed to obtain the configuration data.               | The configured value could not be obtained.                                       | OS may have errors. Restart the server or take other actions.                                                                                                                                                                                                         |
| psqlw       | Error | 98           | Internal error.                                        | Internal error occurred.                                                          | Memory or OS resources may not be sufficient. Check them.                                                                                                                                                                                                             |

### Registry synchronization monitor resource

| Module Type | Type    | Return Value | Message                              | Description                                                              | Solution                                                                                                                                                      |
|-------------|---------|--------------|--------------------------------------|--------------------------------------------------------------------------|---------------------------------------------------------------------------------------------------------------------------------------------------------------|
| regsyncw    | Error   | 50           | Failed to save registry.             | The process of storing to a file at detection of registry update failed. | Check if the process other than EXPRESSCLUSTER opens the registry storage file. Memory or OS resources may not be sufficient. Check the status of the system. |
| regsyncw    | Warning | 101          | Setting of registry keys is invalid. | An invalid registry key is registered to the resource.                   | Check the value set on the Builder ( <b>Details on Resource Properties</b> ), and change to a correct registry key.                                           |

| Module Type | Type    | Return Value | Message                                        | Description                                                | Solution                                                                                                                                                                              |
|-------------|---------|--------------|------------------------------------------------|------------------------------------------------------------|---------------------------------------------------------------------------------------------------------------------------------------------------------------------------------------|
| regsyncw    | Warning | 100          | Delivery processing to other nodes has failed. | Registry storage files cannot be delivered to other nodes. | There may be an error on the connection to the other node. Check the status of the network.<br><br>OS of the local or other server may have an error. Check the status of the system. |

## Disk TUR monitor resource

| Module Type | Type  | Return Value | Message                                                                              | Description                                                                          | Solution                                                                                                                                                                                                                                            |
|-------------|-------|--------------|--------------------------------------------------------------------------------------|--------------------------------------------------------------------------------------|-----------------------------------------------------------------------------------------------------------------------------------------------------------------------------------------------------------------------------------------------------|
| sdw         | Error | 1            | Initialization has failed. Check the cluster configuration data or system resources. | Initialization has failed. Check the cluster configuration data or system resources. | Memory or OS resources may not be sufficient. Check them.                                                                                                                                                                                           |
| sdw         | Error | 2            | Initialization has not been done.                                                    | Initialization has not been done.                                                    | Memory or OS resources may not be sufficient. Check them.                                                                                                                                                                                           |
| sdw         | Error | 3            | The cluster configuration data is invalid.                                           | The cluster configuration data is invalid.                                           | The cluster configuration data is invalid. Check the disk TUR monitor resource on the Builder                                                                                                                                                       |
| sdw         | Error | 4            | Failed to open device. Check the disk status of monitor destination volume.          | Failed to open device. Check the disk status of monitor destination volume.          | Check if the disk driver of the monitoring target disk is loaded, the device exists, the disk is connected properly, the disk is powered on, or no other errors are occurred on the disk. Memory or OS resources may not be sufficient. Check them. |
| sdw         | Error | 5            | Failed to control device. Check the disk status of monitor destination volume.       | Failed to control device. Check the disk status of monitor destination volume.       | Check if the monitoring target disk is connected properly, the disk is powered on, or no other errors are occurred on the disk.                                                                                                                     |
| sdw         | Error | 6            | Internal resources are busy.                                                         | Internal resources are busy.                                                         | Memory or OS resources may not be sufficient. Check them.                                                                                                                                                                                           |
| sdw         | Error | 7            | Failed to allocate memory. Check the system resource.                                | Failed to allocate memory. Check the system resource.                                | Memory or OS resources may not be sufficient. Check them.                                                                                                                                                                                           |

| Module Type | Type  | Return Value | Message                                                                                         | Description                                                                                     | Solution                                                                                                                                                                                                                        |
|-------------|-------|--------------|-------------------------------------------------------------------------------------------------|-------------------------------------------------------------------------------------------------|---------------------------------------------------------------------------------------------------------------------------------------------------------------------------------------------------------------------------------|
| sdw         | Error | 90           | Polling timeout. Check the disk load of the monitor target and extend the monitor timeout time. | Polling timeout. Check the disk load of the monitor target and extend the monitor timeout time. | Check if the monitoring target disk is connected properly, the disk is powered on, or no other errors are occurred on the disk. The system may be under high load, or memory or OS resources may not be sufficient. Check them. |
| sdw         | Error | 99           | Other internal error has occurred. Check the system resource.                                   | Other internal error has occurred. Check the system resource.                                   | Memory or OS resources may not be sufficient. Check them.                                                                                                                                                                       |

### Service monitor resource

| Module Type | Type  | Return Value | Message                                     | Description                                 | Solution                                                  |
|-------------|-------|--------------|---------------------------------------------|---------------------------------------------|-----------------------------------------------------------|
| service w   | Error | 5            | Failed to obtain the service control right. | Failed to obtain the service control right. | Check if the service name is correct.                     |
| service w   | Error | 9            | Service has been stopped.                   | Service has been stopped.                   | Check the status of the service.                          |
| service w   | Error | Others       | An internal error has occurred.             | An internal error has occurred.             | Memory or OS resources may not be sufficient. Check them. |

### Print spooler monitor resource

| Module Type | Type    | Return Value | Message                                                       | Description                                                   | Solution                                       |
|-------------|---------|--------------|---------------------------------------------------------------|---------------------------------------------------------------|------------------------------------------------|
| spoolw      | Error   | 3            | Print spooler service has not been started.(%1!d!)            | Print spooler service has not been started.(%1!d!)            | Start the print spooler service.               |
| spoolw      | Error   | 4            | Failed to get status of print spooler service.(errcode:%1!d!) | Failed to get status of print spooler service.(errcode:%1!d!) | Check the status of the print spooler service. |
| spoolw      | Warning | 100          | Print spooler service is being started.                       | Print spooler service is being started.                       | Check the status of the print spooler service. |

### SMTP monitor resource

| Module Type | Type  | Return Value | Message                        | Description                                                                                                                                 | Solution                                                             |
|-------------|-------|--------------|--------------------------------|---------------------------------------------------------------------------------------------------------------------------------------------|----------------------------------------------------------------------|
| smtpw       | Error | 1            | Initialization has failed[%1]. | Initialization process has failed. It may be due to memory allocation failure.<br>Information on the initialization may be displayed on %1. | OS itself may have errors. Restart the server or take other actions. |

| Module Type | Type  | Return Value | Message                                                | Description                                            | Solution                                                                                                                                       |
|-------------|-------|--------------|--------------------------------------------------------|--------------------------------------------------------|------------------------------------------------------------------------------------------------------------------------------------------------|
| smtpw       | Error | 2            | The configured value is not correct.                   | The configured value of the monitoring is not correct. | Check the configured value on the Builder because it may not be correct.                                                                       |
| smtpw       | Error | 10           | A function error was detected.                         | A function error occurred.                             | Monitor applications or OS may have errors. Check the status of the system.                                                                    |
| smtpw       | Error | 11           | An error was detected in accessing the monitor target. | The access to the monitor application failed.          | Check configured values on the Builder (such as an IP address). If there is no error, check if the monitor application has errors.             |
| smtpw       | Error | 12           | An error was detected in user authentication.          | The access to the monitor application failed.          | Check configured values on the Builder (such as a user name or a password). If there is no error, check if the monitor application has errors. |
| smtpw       | Error | 13           | An application error was detected.                     | The monitor application error was detected.            | Refer to error messages for monitor applications described separately to fix errors.                                                           |
| smtpw       | Error | 15           | A data error was detected.                             | A value of the response data has an error.             | Refer to error messages for monitor applications described separately to fix errors.                                                           |
| smtpw       | Error | 40           | No license is registered.                              | The license has not been registered.                   | Register the license.                                                                                                                          |
| smtpw       | Error | 60           | Failed to obtain the configuration data.               | The configured value could not be obtained.            | OS may have errors. Restart the server or take other actions.                                                                                  |
| smtpw       | Error | 98           | Internal error.                                        | Internal error occurred.                               | Memory or OS resources may not be sufficient. Check them.                                                                                      |

## SQL Server monitor resource

| Module Type | Type  | Return Value | Message                        | Description                                                                                                                                            | Solution                                                             |
|-------------|-------|--------------|--------------------------------|--------------------------------------------------------------------------------------------------------------------------------------------------------|----------------------------------------------------------------------|
| sqlservew   | Error | 1            | Initialization has failed[%1]. | <p>Initialization process has failed. It may be due to memory allocation failure.</p> <p>Information on the initialization may be displayed on %1.</p> | OS itself may have errors. Restart the server or take other actions. |

## Detailed information of monitor resource errors

| Module Type | Type  | Return Value | Message                                                | Description                                                                       | Solution                                                                                                                                                                                                                                                              |
|-------------|-------|--------------|--------------------------------------------------------|-----------------------------------------------------------------------------------|-----------------------------------------------------------------------------------------------------------------------------------------------------------------------------------------------------------------------------------------------------------------------|
| sqlservew   | Error | 2            | The configured value is not correct.                   | The configured value of the monitoring is not correct.                            | Check the configured value on the Builder because it may not be correct.                                                                                                                                                                                              |
| sqlservew   | Error | 10           | A function error was detected.                         | A function error occurred.                                                        | Monitor applications or OS may have errors. Check the status of the system.                                                                                                                                                                                           |
| sqlservew   | Error | 11           | An error was detected in accessing the monitor target. | The access to the database failed.                                                | Check configured values on the Builder (such as a database name). If there is no error, check the database has errors.                                                                                                                                                |
| sqlservew   | Error | 12           | An error was detected in user authentication.          | The access to the database failed.                                                | Check configured values on the Builder (such as a user name or a password). If there is no error, check if the database has errors.                                                                                                                                   |
| sqlservew   | Error | 13           | An application error was detected.                     | The database error was detected.                                                  | Refer to error messages for database described separately to fix errors.                                                                                                                                                                                              |
| sqlservew   | Error | 14           | An error was detected in executing SQL statement [%1]. | Executing SQL statement failed.<br>The executed SQL statement is displayed on %1. | Refer to error messages for database described separately to fix errors.                                                                                                                                                                                              |
| sqlservew   | Error | 15           | A data error was detected.                             | A value on the table of database has an error.                                    | Database may be corrupt. Stop the database operation and investigate it. This error may occur when more than one monitoring is performed with the same monitor table name concurrently. Check if the values set in the multi-directional environment are appropriate. |
| sqlservew   | Error | 40           | No license is registered.                              | The license has not been registered.                                              | Register the license.                                                                                                                                                                                                                                                 |
| sqlservew   | Error | 60           | Failed to obtain the configuration data.               | The configured value could not be obtained.                                       | OS may have errors. Restart the server or take other actions.                                                                                                                                                                                                         |
| sqlservew   | Error | 98           | Internal error.                                        | Internal error occurred.                                                          | Memory or OS resources may not be sufficient. Check them.                                                                                                                                                                                                             |

## Tuxedo monitor resource

| Module Type | Type  | Return Value | Message                                                | Description                                                                                                                                 | Solution                                                                                                                                        |
|-------------|-------|--------------|--------------------------------------------------------|---------------------------------------------------------------------------------------------------------------------------------------------|-------------------------------------------------------------------------------------------------------------------------------------------------|
| tuxw        | Error | 1            | Initialization has failed[%1].                         | Initialization process has failed. It may be due to memory allocation failure.<br>Information on the initialization may be displayed on %1. | OS itself may have errors. Restart the server or take other actions.                                                                            |
| tuxw        | Error | 2            | The configured value is not correct.                   | The configured value of the monitoring is not correct.                                                                                      | Check the configured value on the Builder since it may not be correct.                                                                          |
| tuxw        | Error | 10           | A function error was detected.                         | A function error occurred.                                                                                                                  | Monitor applications or OS may have errors. Check the status of the system.                                                                     |
| tuxw        | Error | 11           | An error was detected in accessing the monitor target. | The access to the monitor application failed.                                                                                               | Check configured values on the Builder (such as an application config file). If there is no error, check if the monitor application has errors. |
| tuxw        | Error | 13           | An application error was detected.                     | The monitor application error was detected.                                                                                                 | Refer to error messages for monitor applications described separately to fix errors.                                                            |
| tuxw        | Error | 40           | No license is registered.                              | The license has not been registered.                                                                                                        | Register the license.                                                                                                                           |
| tuxw        | Error | 60           | Failed to obtain the configuration data.               | The configured value could not be obtained.                                                                                                 | OS may have errors. Restart the server or take other actions.                                                                                   |
| tuxw        | Error | 98           | Internal error.                                        | Internal error occurred.                                                                                                                    | Memory or OS resources may not be sufficient. Check them.                                                                                       |

## Virtual computer name monitor resource

| Module Type | Type  | Return Value | Message                                        | Description                                    | Solution                                                                     |
|-------------|-------|--------------|------------------------------------------------|------------------------------------------------|------------------------------------------------------------------------------|
| vcomw       | Error | 5            | VCOM control process has already been started. | VCOM control process has already been started. | Memory or OS resources may not be sufficient. Check them.<br>Restart the OS. |
| vcomw       | Error | 6            | VCOM control process has not been started.     | VCOM control process has not been started.     | Memory or OS resources may not be sufficient. Check them.<br>Restart the OS. |

| Module Type | Type  | Return Value | Message                              | Description                          | Solution                                                       |
|-------------|-------|--------------|--------------------------------------|--------------------------------------|----------------------------------------------------------------|
| vcomw       | Error | 8            | VCOM control process does not exist. | VCOM control process does not exist. | The VCOM control process ID does not exist.<br>Restart the OS. |
| vcomw       | Error | Others       | An internal error has occurred.      | An internal error has occurred.      | Memory or OS resources may not be sufficient. Check them.      |

### Virtual IP monitor resource

| Module Type | Type  | Return Value | Message                         | Description                     | Solution                                                                             |
|-------------|-------|--------------|---------------------------------|---------------------------------|--------------------------------------------------------------------------------------|
| vipw        | Error | 6            | IP address does not exist.      | IP address does not exist.      | NIC may have been disabled. Check if the VIP address exists by the ipconfig command. |
| vipw        | Error | 11           | Adapter Index is different.     | Adapter Index is different.     | NIC may have been disabled. Check if the VIP address exists by the ipconfig command. |
| vipw        | Error | Others       | An internal error has occurred. | An internal error has occurred. | Memory or OS resources may not be sufficient. Check them.                            |

### VM monitor resource

| Module Type | Type  | Return Value | Message                          | Description                                                      | Solution                                                    |
|-------------|-------|--------------|----------------------------------|------------------------------------------------------------------|-------------------------------------------------------------|
| vmw         | Error | 12           | Virtual machine is unnormal [%1] | The status of the virtual machine is other than <b>Running</b> . | Check the status of the virtual machine on Hyper-V manager. |
| vmw         | Error | Others       | Internal error occurred.         | Internal error occurred.                                         | Memory or OS resources may not be sufficient. Check them.   |

### Websphere monitor resource

| Module Type | Type  | Return Value | Message                              | Description                                                                                                                                 | Solution                                                                 |
|-------------|-------|--------------|--------------------------------------|---------------------------------------------------------------------------------------------------------------------------------------------|--------------------------------------------------------------------------|
| wasw        | Error | 1            | Initialization has failed[%1].       | Initialization process has failed. It may be due to memory allocation failure.<br>Information on the initialization may be displayed on %1. | OS itself may have errors. Restart the server or take other actions.     |
| wasw        | Error | 2            | The configured value is not correct. | The configured value of the monitoring is not correct.                                                                                      | Check the configured value on the Builder because it may not be correct. |

| Module Type | Type  | Return Value | Message                                       | Description                                   | Solution                                                                                                                                       |
|-------------|-------|--------------|-----------------------------------------------|-----------------------------------------------|------------------------------------------------------------------------------------------------------------------------------------------------|
| wasw        | Error | 10           | A function error was detected.                | A function error occurred.                    | Monitor applications or OS may have errors. Check the status of the system.                                                                    |
| wasw        | Error | 12           | An error was detected in user authentication. | The access to the monitor application failed. | Check configured values on the Builder (such as a user name or a password). If there is no error, check if the monitor application has errors. |
| wasw        | Error | 13           | An application error was detected.            | The monitor application error was detected.   | Refer to error messages for monitor applications described separately to fix errors.                                                           |
| wasw        | Error | 40           | No license is registered.                     | The license has not been registered.          | Register the license.                                                                                                                          |
| wasw        | Error | 60           | Failed to obtain the configuration data.      | The configured value could not be obtained.   | OS may have errors. Restart the server or take other actions.                                                                                  |
| wasw        | Error | 98           | Internal error.                               | Internal error occurred.                      | Memory or OS resources may not be sufficient. Check them.                                                                                      |

## Weblogic monitor resource

| Module Type | Type  | Return Value | Message                                                | Description                                                                                                                                 | Solution                                                                                                                           |
|-------------|-------|--------------|--------------------------------------------------------|---------------------------------------------------------------------------------------------------------------------------------------------|------------------------------------------------------------------------------------------------------------------------------------|
| wlsw        | Error | 1            | Initialization has failed[%1].                         | Initialization process has failed. It may be due to memory allocation failure.<br>Information on the initialization may be displayed on %1. | OS itself may have errors. Restart the server or take other actions.                                                               |
| wlsw        | Error | 2            | The configured value is not correct.                   | The configured value of the monitoring is not correct.                                                                                      | Check the configured value on the Builder because it may not be correct.                                                           |
| wlsw        | Error | 10           | A function error was detected.                         | A function error occurred.                                                                                                                  | Monitor applications or OS may have errors. Check the status of the system.                                                        |
| wlsw        | Error | 11           | An error was detected in accessing the monitor target. | The access to the monitor application failed.                                                                                               | Check configured values on the Builder (such as an IP address). If there is no error, check if the monitor application has errors. |



| Module Type | Type  | Return Value | Message                                       | Description                                   | Solution                                                                                                                                       |
|-------------|-------|--------------|-----------------------------------------------|-----------------------------------------------|------------------------------------------------------------------------------------------------------------------------------------------------|
| wlsw        | Error | 12           | An error was detected in user authentication. | The access to the monitor application failed. | Check configured values on the Builder (such as a user name or a password). If there is no error, check if the monitor application has errors. |
| wlsw        | Error | 13           | An application error was detected.            | The monitor application error was detected.   | Refer to error messages for monitor applications described separately to fix errors.                                                           |
| wlsw        | Error | 40           | No license is registered.                     | The license has not been registered.          | Register the license.                                                                                                                          |
| wlsw        | Error | 60           | Failed to obtain the configuration data.      | The configured value could not be obtained.   | OS may have errors. Restart the server or take other actions.                                                                                  |
| wlsw        | Error | 98           | Internal error.                               | Internal error occurred.                      | Memory or OS resources may not be sufficient. Check them.                                                                                      |

## WebOTX monitor resource

| Module Type | Type  | Return Value | Message                                                | Description                                                                                                                                 | Solution                                                                                                                                                         |
|-------------|-------|--------------|--------------------------------------------------------|---------------------------------------------------------------------------------------------------------------------------------------------|------------------------------------------------------------------------------------------------------------------------------------------------------------------|
| otxw        | Error | 1            | Initialization has failed[%1].                         | Initialization process has failed. It may be due to memory allocation failure.<br>Information on the initialization may be displayed on %1. | OS itself may have errors. Restart the server or take other actions.                                                                                             |
| otxw        | Error | 2            | The configured value is not correct.                   | The configured value of the monitoring is not correct.                                                                                      | Check the configured value on the Builder because it may not be correct.                                                                                         |
| otxw        | Error | 10           | A function error was detected.                         | A function error occurred.                                                                                                                  | Monitor applications or OS may have errors. Check the status of the system.                                                                                      |
| otxw        | Error | 11           | An error was detected in accessing the monitor target. | The access to the monitor application failed.                                                                                               | Check configured values on the Builder (such as an IP address or an application server name). If there is no error, check if the monitor application has errors. |
| otxw        | Error | 12           | An error was detected in user authentication.          | The access to the monitor application failed.                                                                                               | Check configured values on the Builder (such as a user name or a password). If there is no error, check if the monitor application has errors.                   |

| Module Type | Type  | Return Value | Message                                  | Description                                 | Solution                                                                             |
|-------------|-------|--------------|------------------------------------------|---------------------------------------------|--------------------------------------------------------------------------------------|
| otxw        | Error | 13           | An application error was detected.       | The monitor application error was detected. | Refer to error messages for monitor applications described separately to fix errors. |
| otxw        | Error | 40           | No license is registered.                | The license has not been registered.        | Register the license.                                                                |
| otxw        | Error | 60           | Failed to obtain the configuration data. | The configured value could not be obtained. | OS may have errors. Restart the server or take other actions.                        |
| otxw        | Error | 98           | Internal error.                          | Internal error occurred.                    | Memory or OS resources may not be sufficient. Check them.                            |

### JVM monitor resource

| Module Type | Type  | Return Value | Message                                                              | Description                                               | Solution                                                                                     |
|-------------|-------|--------------|----------------------------------------------------------------------|-----------------------------------------------------------|----------------------------------------------------------------------------------------------|
| jraw        | Error | 11           | An error was detected in accessing the monitor target.               | Connection to the target to be monitored has failed.      | Check that the Java VM to be monitored is running.                                           |
| jraw        | Error | 12           | %1 to be monitored has become abnormal.<br>%1:Error generation cause | An error in the target to be monitored has been detected. | Based on the message, check the Java application that is running on Java VM to be monitored. |
| jraw        | Error | 99           | Internal error occurred.                                             | An internal error has occurred.                           | Execute cluster suspend and cluster resume.                                                  |

### System monitor resource

| Module Type | Type  | Return Value | Message                                                                                    | Description                                             | Solution                                  |
|-------------|-------|--------------|--------------------------------------------------------------------------------------------|---------------------------------------------------------|-------------------------------------------|
| sraw        | Error | 11           | Monitor sraw has detected an error. (11: Detected an error in monitoring system resource.) | An error was detected when monitoring system resources. | There may be an error with the resources. |

### Dynamic DNS monitoring resource

| Module Type | Type  | Return Value | Message                                             | Description                                                                       | Solution                              |
|-------------|-------|--------------|-----------------------------------------------------|-----------------------------------------------------------------------------------|---------------------------------------|
| ddnsw       | Error | 1            | Parameter is invalid.                               | The dynamic DNS resource or dynamic DNS monitoring resource parameter is invalid. | Check the cluster configuration data. |
| ddnsw       | Error | 2            | Group does not exist in cluster configuration data. | Group does not exist in cluster configuration data.                               | Check the cluster configuration data. |

| Module Type | Type  | Return Value | Message                                                  | Description                                              | Solution                                                                                                                                                                                                        |
|-------------|-------|--------------|----------------------------------------------------------|----------------------------------------------------------|-----------------------------------------------------------------------------------------------------------------------------------------------------------------------------------------------------------------|
| ddnsw       | Error | 3            | Resource does not exist in cluster configuration data.   | Resource does not exist in cluster configuration data.   | Check the cluster configuration data.                                                                                                                                                                           |
| ddnsw       | Error | 4            | Failed to get the value from cluster configuration data. | Failed to get the value from cluster configuration data. | Check the cluster configuration data.                                                                                                                                                                           |
| ddnsw       | Error | 5            | Query to DNS has failed.                                 | Query to DNS has failed.                                 | Check the DNS server setting. Make sure that communication with the DNS server is enabled.                                                                                                                      |
| ddnsw       | Error | 6            | Failed to delete DNS.                                    | Failed to delete DNS.                                    | Check the DNS server setting. Make sure that communication with the DNS server is enabled.                                                                                                                      |
| ddnsw       | Error | 7            | Failed to update DNS.                                    | Failed to update DNS.                                    | Check the DNS server setting. Make sure that communication with the DNS server is enabled.                                                                                                                      |
| ddnsw       | Error | 8            | A reception timeout occurred.                            | A reception timeout occurred.                            | Memory or OS resources may not be sufficient. Check them.                                                                                                                                                       |
| ddnsw       | Error | 9            | Failed to send to the DNS server.                        | Failed to send to the DNS server.                        | Check the DNS server setting. Make sure that communication with the DNS server is enabled.                                                                                                                      |
| ddnsw       | Error | 10           | Failed to receive from the DNS server.                   | Failed to receive from the DNS server.                   | Check the DNS server setting. Make sure that communication with the DNS server is enabled.                                                                                                                      |
| ddnsw       | Error | 11           | Ping has not reached.                                    | Ping has not reached.                                    | Check whether the ping command is successfully executed for the target IP address. If the ping command failed, check the status of the device that uses the target IP address, or the network interface status. |
| ddnsw       | Error | 12           | Ping timeout occurred.                                   | Ping timeout occurred.                                   | Memory or OS resources may not be sufficient. Check them.                                                                                                                                                       |
| ddnsw       | Error | 13           | DDNS control process has already started.                | DDNS control process has already started.                | Memory or OS resources may not be sufficient. Check them. Or, the previous activation might fail. In this case, stop the cluster and kill the DDNS control process (clpddnsp.exe) manually.                     |

| Module Type | Type  | Return Value | Message                               | Description                           | Solution                                                                                                                                                 |
|-------------|-------|--------------|---------------------------------------|---------------------------------------|----------------------------------------------------------------------------------------------------------------------------------------------------------|
| ddnsw       | Error | 14           | DDNS control process is not running.  | DDNS control process is not running.  | Check the DNS server setting. Make sure that communication with the DNS server is enabled. Or, memory or OS resources may not be sufficient. Check them. |
| ddnsw       | Error | 16           | Failed to start DDNS control process. | Failed to start DDNS control process. | Check the DNS server setting. Make sure that communication with the DNS server is enabled. Or, memory or OS resources may not be sufficient. Check them. |
| ddnsw       | Error | 17           | Failed to stop DDNS control process.  | Failed to stop DDNS control process.  | Check the DNS server setting. Make sure that communication with the DNS server is enabled. Or, memory or OS resources may not be sufficient. Check them. |
| ddnsw       | Error | 18           | DDNS control process path is invalid. | DDNS control process path is invalid. | The executable file is damaged, or memory or OS resources may not be sufficient. Check them.                                                             |
| ddnsw       | Error | 99           | Internal error occurred.              | Internal error occurred.              | Memory or OS resources may not be sufficient. Check them.                                                                                                |

## User space monitoring resource

| Module Type | Type  | Return Value | Message                                                             | Description                                                         | Solution                                                                                      |
|-------------|-------|--------------|---------------------------------------------------------------------|---------------------------------------------------------------------|-----------------------------------------------------------------------------------------------|
| userw       | Error | 1            | An initialization error has occurred in an internal resource.       | An initialization error has occurred in an internal resource.       | Memory or OS resources may not be sufficient. Check them.                                     |
| userw       | Error | 2            | Failed to add keep alive drive when initializing keep alive driver. | Failed to add keep alive drive when initializing keep alive driver. | Memory or OS resources may not be sufficient. Check them.                                     |
| userw       | Error | 3            | Initialization has not been done.                                   | Initialization has not been done.                                   | Memory or OS resources may not be sufficient. Check them.                                     |
| userw       | Error | 4            | Failed to obtain the cluster configuration data.                    | Failed to obtain the cluster configuration data.                    | The cluster configuration data is invalid. Check the disk RW monitor resource on the Builder. |
| userw       | Error | 10           | Failed to allocate memory.                                          | Failed to allocate memory.                                          | Memory or OS resources may not be sufficient. Check them.                                     |
| userw       | Error | 70           | A timeout occurred when initializing internal resources.            | A timeout occurred when initializing internal resources.            | Memory or OS resources may not be sufficient. Check them.                                     |

| Module Type | Type  | Return Value | Message                     | Description                 | Solution                                                  |
|-------------|-------|--------------|-----------------------------|-----------------------------|-----------------------------------------------------------|
| userw       | Error | 99           | An internal error occurred. | An internal error occurred. | Memory or OS resources may not be sufficient. Check them. |

## AWS elastic ip monitor resources

| Module type | Type    | Return value | Message                         | Description                     | Solution                                                                                                                                         |
|-------------|---------|--------------|---------------------------------|---------------------------------|--------------------------------------------------------------------------------------------------------------------------------------------------|
| awseipw     | Error   | 5            | AWS CLI command failed.         | Failed in the AWS CLI command.  | Check if the settings in the AWS CLI file are correct.                                                                                           |
| awseipw     | Error   | 6            | Timeout occurred.               | Timeout occurred.               | Memory or OS resources may not be sufficient. Check them.                                                                                        |
| awseipw     | Error   | 7            | The EIP address does not exist. | The EIP address does not exist. | The EIP may have been detached. Check it.                                                                                                        |
| awseipw     | Error   | 99           | Internal error occurred.        | Internal error occurred.        | Check if Python is installed correctly.<br>Check if AWS CLI is installed correctly.<br>Memory or OS resources may not be sufficient. Check them. |
| awseipw     | Warning | 105          | AWS CLI command failed.         | Failed in the AWS CLI command.  | Check if the settings in the AWS CLI file are correct.                                                                                           |
| awseipw     | Warning | 106          | Timeout occurred.               | Timeout occurred.               | Memory or OS resources may not be sufficient. Check them.                                                                                        |

## AWS virtual ip monitor resources

| Module type | Type  | Return value | Message                          | Description                      | Solution                                                                                  |
|-------------|-------|--------------|----------------------------------|----------------------------------|-------------------------------------------------------------------------------------------|
| awsvipw     | Error | 5            | AWS CLI command failed.          | Failed in the AWS CLI command.   | Check if the settings in the AWS CLI file are correct.                                    |
| awsvipw     | Error | 6            | Timeout occurred.                | Timeout occurred.                | Memory or OS resources may not be sufficient. Check them.                                 |
| awsvipw     | Error | 7            | The VIP address does not exist.  | The VIP address does not exist.  | NIC may have been disabled.<br>Check if the VIP address exists with the ifconfig command. |
| awsvipw     | Error | 8            | The routing for VIP was changed. | The routing for VIP was changed. | The VIP routing may have been changed.<br>Check the Route Tables of the VPC.              |

| Module type | Type    | Return value | Message                  | Description                    | Solution                                                                                                                                         |
|-------------|---------|--------------|--------------------------|--------------------------------|--------------------------------------------------------------------------------------------------------------------------------------------------|
| awsvipw     | Error   | 99           | Internal error occurred. | Internal error occurred.       | Check if Python is installed correctly.<br>Check if AWS CLI is installed correctly.<br>Memory or OS resources may not be sufficient. Check them. |
| awsvipw     | Warning | 105          | AWS CLI command failed.  | Failed in the AWS CLI command. | Check if the settings in the AWS CLI file are correct.                                                                                           |
| awsvipw     | Warning | 106          | Timeout occurred.        | Timeout occurred.              | Memory or OS resources may not be sufficient. Check them.                                                                                        |

## AWS AZ monitor resources

| Module type | Type    | Return value | Message                                  | Description                                        | Solution                                                                                                                                         |
|-------------|---------|--------------|------------------------------------------|----------------------------------------------------|--------------------------------------------------------------------------------------------------------------------------------------------------|
| awsazw      | Error   | 4            | Failed to monitor the availability zone. | Failed to monitor the availability zone.           | The availability zone to which the server belongs may have a problem. Check it.                                                                  |
| awsazw      | Error   | 5            | AWS CLI command failed.                  | Failed in the AWS CLI command.                     | Check if the settings in the AWS CLI file are correct.                                                                                           |
| awsazw      | Error   | 5            | Invalid availability zone: [%1]          | The specified availability zone %1 does not exist. | Check if the settings of the availability zone are correct.                                                                                      |
| awsazw      | Error   | 6            | Timeout occurred.                        | Timeout occurred.                                  | Memory or OS resources may not be sufficient. Check them.                                                                                        |
| awsazw      | Error   | 99           | Internal error occurred.                 | Internal error occurred.                           | Check if Python is installed correctly.<br>Check if AWS CLI is installed correctly.<br>Memory or OS resources may not be sufficient. Check them. |
| awsazw      | Warning | 105          | AWS CLI command failed.                  | Failed in the AWS CLI command.                     | Check if the settings in the AWS CLI file are correct.                                                                                           |
| awsazw      | Warning | 105          | Invalid availability zone: [%1]          | The specified availability zone %1 does not exist. | Check if the settings of the availability zone are correct.                                                                                      |
| awsazw      | Warning | 106          | Timeout occurred.                        | Timeout occurred.                                  | Memory or OS resources may not be sufficient. Check them.                                                                                        |

## Azure probe port monitor resource

| Module type | Type    | Return value | Message                                 | Description                             | Solution                                                                                                                                                                                                                 |
|-------------|---------|--------------|-----------------------------------------|-----------------------------------------|--------------------------------------------------------------------------------------------------------------------------------------------------------------------------------------------------------------------------|
| azureppw    | Error   | 4            | Probe port is closed.                   | Probe port is closed.                   | The probe port is closed.<br>Check the network settings on the server.                                                                                                                                                   |
| azureppw    | Error   | 5            | Timeout of waiting probe port occurred. | Timeout of waiting probe port occurred. | The server could not receive the probe from the Azure load balancer in the probe wait timeout.<br>Check if an error does not occur with a network adaptor.<br>Check if the server is connected to the network correctly. |
| azureppw    | Error   | 6            | Monitoring probe port failed.           | Monitoring probe port failed.           | Memory or OS resources may not be sufficient. Check them.                                                                                                                                                                |
| azureppw    | Error   | 7            | Monitoring probe port is frozen.        | Monitoring probe port is frozen.        | Memory or OS resources may not be sufficient. Check them.                                                                                                                                                                |
| azureppw    | Error   | 99           | Internal error occurred.                | Internal error occurred.                | Memory or OS resources may not be sufficient. Check them.                                                                                                                                                                |
| azureppw    | Warning | 105          | Timeout of waiting probe port occurred. | Timeout of waiting probe port occurred. | The server could not receive the probe from the Azure load balancer in the probe wait timeout.<br>Check if an error does not occur with a network adaptor.<br>Check if the server is connected to the network correctly. |

### Azure load balance monitor resource

| Module type | Type  | Return value | Message                       | Description                   | Solution                                                                                                               |
|-------------|-------|--------------|-------------------------------|-------------------------------|------------------------------------------------------------------------------------------------------------------------|
| azurelbw    | Error | 4            | Probe port is opened.         | Probe port is opened.         | The probe has been opened on the standby server.<br>Make sure that the probe port is not opened on the standby server. |
| azurelbw    | Error | 5            | Monitoring probe port failed. | Monitoring probe port failed. | Memory or OS resources may not be sufficient. Check them.                                                              |
| azurelbw    | Error | 99           | Internal error occurred.      | Internal error occurred.      | Memory or OS resources may not be sufficient. Check them.                                                              |

## STOP codes list of disk RW monitor resources

The following information is the STOP error codes list which are generated when selecting **Generating of intentional Stop Error on Action when stalling is detected** of disk RW monitor resource.

| STOP code  | Description                                                                                                                                                                                                                        |
|------------|------------------------------------------------------------------------------------------------------------------------------------------------------------------------------------------------------------------------------------|
| 0xE0000000 | The STOP error which was generated as the Final action at detection of an error of the monitor resource at activation or deactivation failure of the group resource.                                                               |
| 0xE000FF** | The STOP error which was generated by keep alive timeout (the timeout of disk RW monitor).<br>The lower 8 bits (the part of "**") shows the following checkpoint (The chances are high that it was being executed during timeout). |
| 0xE000FF00 | The internal processing of EXPRESSCLUSTER                                                                                                                                                                                          |
| 0xE000FF01 | free(), SetWaitableTimer(), GetTickCount(), WaitForMultipleObjects()                                                                                                                                                               |
| 0xE000FF02 | CreateFile(), _beginthreadex()                                                                                                                                                                                                     |
| 0xE000FF03 | malloc(), WriteFile()                                                                                                                                                                                                              |
| 0xE000FF04 | FlushFileBuffers()                                                                                                                                                                                                                 |
| 0xE000FF05 | CloseHandle()                                                                                                                                                                                                                      |
| 0xE000FF06 | The internal processing of EXPRESSCLUSTER                                                                                                                                                                                          |

## Filter driver STOP code list

The following lists the STOP error codes generated by the EXPRESSCLUSTER filter driver (clpdiskfltr.sys).

| STOP code  | Description                                                                                                            |
|------------|------------------------------------------------------------------------------------------------------------------------|
| 0xE000FD00 | A fatal internal error has occurred in the filter driver.                                                              |
| 0xE000FD01 | A timeout has occurred during monitoring of the CLUSTER partitions (monitoring by reading and writing for partitions). |
| 0xE000FD02 | It is not possible to access the data partition for mirror disk resources or hybrid disk resources.                    |
| 0xE000FD03 | It is not possible to access the cluster partition for mirror disk resources or hybrid disk resources.                 |



## JVM monitor resource log output messages

The following messages belong to the JVM operation and JVM load balancer linkage log files that are specific to the JVM monitor resources.

### JVM operation log

| Message                                        | Cause of generation                                                                                                                                                                                                                                                                                                                                                     | Action                                                                           |
|------------------------------------------------|-------------------------------------------------------------------------------------------------------------------------------------------------------------------------------------------------------------------------------------------------------------------------------------------------------------------------------------------------------------------------|----------------------------------------------------------------------------------|
| Failed to write the %1.stat.                   | Writing to the JVM statistics log has failed.<br><br>%1 .stat: JVM statistics log file name                                                                                                                                                                                                                                                                             | Check whether there is sufficient free disk space.                               |
| %1: analyze finish[%4]. state = %2, cause = %3 | (When the status of the Java VM to be monitored is abnormal) the resource use amount has exceeded the threshold in the Java VM to be monitored.<br><br>%1: Name of the Java VM to be monitored<br><br>%2: Status of Java VM to be monitored<br>(1=normal, 0=abnormal)<br><br>%3: Error generation location at abnormality occurrence<br><br>%4: Measurement thread name | Review the Java application that runs on the Java VM to be monitored.            |
| thread stopped by UncaughtException.           | The thread of the JVM monitor resource has stopped.                                                                                                                                                                                                                                                                                                                     | Execute cluster suspend/cluster resume and then restart the Java Resource Agent. |
| thread wait stopped by Exception.              | The thread of the JVM monitor resource has stopped.                                                                                                                                                                                                                                                                                                                     | Execute cluster suspend/cluster resume and then restart the Java Resource Agent. |
| %1: monitor thread can't connect to JVM.       | The Java VM to be monitored could not be connected.<br><br>%1: Name of the Java VM to be monitored                                                                                                                                                                                                                                                                      | Check that the Java VM to be monitored is running.                               |
| %1: monitor thread can't get the JVM state.    | The resource use amount could not be acquired from Java VM to be monitored.<br><br>%1: Name of the Java VM to be monitored                                                                                                                                                                                                                                              | Check that the Java VM to be monitored is running.                               |
| %1: JVM state is changed [abnormal -> normal]. | The status of the Java VM to be monitored has changed from abnormal to normal.<br><br>%1: Name of the Java VM to be monitored                                                                                                                                                                                                                                           | -                                                                                |
| %1: JVM state is changed [normal -> abnormal]. | The status of the Java VM to be monitored has changed from normal to abnormal.<br><br>%1: Name of the Java VM to be monitored                                                                                                                                                                                                                                           | Review the Java application that runs on the Java VM to be monitored.            |
| %1: Failed to connect to JVM.                  | The Java VM to be monitored could not be connected.<br><br>%1: Name of the Java VM to be monitored                                                                                                                                                                                                                                                                      | Check that the Java VM to be monitored is running.                               |

| Message                                                                                             | Cause of generation                                                                                                                                                                                                                                                                                                                                                     | Action                                                                                                                                                |
|-----------------------------------------------------------------------------------------------------|-------------------------------------------------------------------------------------------------------------------------------------------------------------------------------------------------------------------------------------------------------------------------------------------------------------------------------------------------------------------------|-------------------------------------------------------------------------------------------------------------------------------------------------------|
| Failed to write exit code.                                                                          | The JVM monitor resource failed to write data to the file for recording the exit code.                                                                                                                                                                                                                                                                                  | Check whether there is sufficient free disk space.                                                                                                    |
| Failed to be started JVMSaver.                                                                      | Starting of the JVM monitor resource has failed.                                                                                                                                                                                                                                                                                                                        | Check the JVM operation log, remove the cause preventing the start, execute cluster suspend/cluster resume, and then restart the Java Resource Agent. |
| JVMSaver already started.                                                                           | The JVM monitor resource has already been started.                                                                                                                                                                                                                                                                                                                      | Execute cluster suspend/cluster resume and then restart the Java Resource Agent.                                                                      |
| %1: GARBAGE_COLLECTOR_MXBEAN_D OMAIN_TYPE is invalid.                                               | GC information could not be acquired from the Java VM to be monitored.<br><br>%1: Name of the Java VM to be monitored                                                                                                                                                                                                                                                   | Check whether the operating environment of the Java VM to be monitored is correct.                                                                    |
| %1: GarbageCollectorMXBean is invalid.                                                              | GC information could not be acquired from the Java VM to be monitored.<br><br>%1: Name of the Java VM to be monitored                                                                                                                                                                                                                                                   | Check whether the operating environment of the Java VM to be monitored is correct.                                                                    |
| %1: Failed to measure the GC stat.                                                                  | GC information could not be acquired from the Java VM to be monitored.<br><br>%1: Name of the Java VM to be monitored                                                                                                                                                                                                                                                   | Check whether the operating environment of the Java VM to be monitored is correct.                                                                    |
| %1: GC stat is invalid. last.getCount = %2, last.getTime = %3, now.getCount = %4, now.getTime = %5. | The GC generation count and GC execution time could not be measured for the Java VM to be monitored.<br><br>%1: Name of the Java VM to be monitored<br><br>%2: GC generation count at last measurement<br><br>%3: Total GC execution time at last measurement<br><br>%4: GC generation count at this measurement<br><br>%5: Total GC execution time at this measurement | Check whether the operating environment of the Java VM to be monitored is correct.                                                                    |

| Message                                                                                                                                                 | Cause of generation                                                                                                                                                                                                                                                                                                                                                                                                                                                                                                         | Action                                                                |
|---------------------------------------------------------------------------------------------------------------------------------------------------------|-----------------------------------------------------------------------------------------------------------------------------------------------------------------------------------------------------------------------------------------------------------------------------------------------------------------------------------------------------------------------------------------------------------------------------------------------------------------------------------------------------------------------------|-----------------------------------------------------------------------|
| %1: GC average time is too long. av = %6, last.getCount = %2, last.getTime = %3, now.getCount = %4, now.getTime = %5.                                   | <p>The average GC execution time has exceeded the threshold in the Java VM to be monitored.</p> <p>%1: Name of the Java VM to be monitored</p> <p>%2: GC generation count at last measurement</p> <p>%3: Total GC execution time at last measurement</p> <p>%4: GC generation count at this measurement</p> <p>%5: Total GC execution time at this measurement</p> <p>%6: Average of the GC execution time used from the last measurement to this measurement</p>                                                           | Review the Java application that runs on the Java VM to be monitored. |
| %1: GC average time is too long compared with the last connection. av = %6, last.getCount = %2, last.getTime = %3, now.getCount = %4, now.getTime = %5. | <p>After the Java VM to be monitored was reconnected, the average of the GC execution time has exceeded the threshold in the Java VM to be monitored.</p> <p>%1: Name of the Java VM to be monitored</p> <p>%2: GC generation count at last measurement</p> <p>%3: Total GC execution time at last measurement</p> <p>%4: GC generation count at this measurement</p> <p>%5: Total GC execution time at this measurement</p> <p>%6: Average of the GC execution time used from the last measurement to this measurement</p> | Review the Java application that runs on the Java VM to be monitored. |
| %1: GC count is too frequently. count = %4 last.getCount = %2, now.getCount = %3.                                                                       | <p>The GC generation count has exceeded the threshold in the Java VM to be monitored.</p> <p>%1: Name of the Java VM to be monitored</p> <p>%2: GC generation count at last measurement</p> <p>%3: GC generation count at this measurement</p> <p>%4: GC generation count from the last measurement to this measurement</p>                                                                                                                                                                                                 | Review the Java application that runs on the Java VM to be monitored. |

| Message                                                                                                             | Cause of generation                                                                                                                                                                                                                                                                                                                                                            | Action                                                                                                                                                                     |
|---------------------------------------------------------------------------------------------------------------------|--------------------------------------------------------------------------------------------------------------------------------------------------------------------------------------------------------------------------------------------------------------------------------------------------------------------------------------------------------------------------------|----------------------------------------------------------------------------------------------------------------------------------------------------------------------------|
| %1: GC count is too frequently compared with the last connection. count = %4 last.getCount = %2, now.getCount = %3. | <p>After the Java VM to be monitored was reconnected, the GC generation count has exceeded the threshold in the Java VM to be monitored.</p> <p>%1: Name of the Java VM to be monitored</p> <p>%2: GC generation count at last measurement</p> <p>%3: GC generation count at this measurement</p> <p>%4: GC generation count from the last measurement to this measurement</p> | Review the Java application that runs on the Java VM to be monitored.                                                                                                      |
| %1: RUNTIME_MXBEAN_NAME is invalid.                                                                                 | <p>C heap information could not be acquired from the Java VM to be monitored.</p> <p>%1: Name of the Java VM to be monitored</p>                                                                                                                                                                                                                                               | Check whether the operating environment of the Java VM to be monitored is correct.                                                                                         |
| %1: RuntimeMXBean is invalid.                                                                                       | <p>Information could not be acquired from the Java VM to be monitored.</p> <p>%1: Name of the Java VM to be monitored</p>                                                                                                                                                                                                                                                      | Check whether the operating environment of the Java VM to be monitored is correct.                                                                                         |
| %1: Failed to measure the runtime stat.                                                                             | <p>Information could not be acquired from the Java VM to be monitored.</p> <p>%1: Name of the Java VM to be monitored</p>                                                                                                                                                                                                                                                      | <p>Check whether the operating environment of the Java VM to be monitored is correct.</p> <p>Check whether the processing load is high in the Java VM to be monitored.</p> |
| %1: Process C-Heap capacity is too little. pname = %2, pid = %4, capacity = %3.                                     | <p>The C heap free space has fallen below the threshold in the Java VM to be monitored.</p> <p>%1: Name of the Java VM to be monitored</p> <p>%2: Command line of the process to be monitored</p> <p>%3: C heap free space</p> <p>%4: ID of the process to be monitored</p>                                                                                                    | Review the Java application that runs on the Java VM to be monitored.                                                                                                      |
| %1: Failed to measure C-Heap capacity. stdout = %2,stderr = %3.                                                     | <p>The C heap free space could not be measured in the Java VM to be monitored.</p> <p>%1: Name of the Java VM to be monitored</p> <p>%2: Standard output of the C heap measurement program</p> <p>%3: Standard error output of the C heap measurement program</p>                                                                                                              | Check whether the machine load is high.                                                                                                                                    |
| %1: Failed to measure C-Heap capacity. timeout at gap_chk.                                                          | <p>The C heap free space could not be measured in the Java VM to be monitored due to a timeout.</p> <p>%1: Name of the Java VM to be monitored</p>                                                                                                                                                                                                                             | Check whether the machine load is high.                                                                                                                                    |

| Message                                                                                   | Cause of generation                                                                                                                                                                                                                                                                                                                                     | Action                                                                                                                                                              |
|-------------------------------------------------------------------------------------------|---------------------------------------------------------------------------------------------------------------------------------------------------------------------------------------------------------------------------------------------------------------------------------------------------------------------------------------------------------|---------------------------------------------------------------------------------------------------------------------------------------------------------------------|
| %1: Failed to measure C-Heap capacity. execute error at gap_chk.stderr = %2.              | The C heap free space could not be measured in the Java VM to be monitored.<br><br>%1: Name of the Java VM to be monitored<br><br>%2: Standard error output of the C heap measurement program                                                                                                                                                           | Check whether the machine load is high.                                                                                                                             |
| %1: Failed to measure C-Heap capacity. execute error at gap_chk.cause = %2.               | The C heap free space could not be measured in the Java VM to be monitored.<br><br>%1: Name of the Java VM to be monitored<br><br>%2: Detailed error information of C heap measurement program execution failure                                                                                                                                        | Check whether the machine load is high.                                                                                                                             |
| %1: MEMORY_MXBEAN_NAME is invalid. %2, %3.                                                | Memory information could not be acquired from the Java VM to be monitored.<br><br>%1: Name of the Java VM to be monitored<br><br>%2: Memory pool name<br><br>%3: Memory name                                                                                                                                                                            | Check whether the operating environment of the Java VM to be monitored is correct.                                                                                  |
| %1: MemoryMXBean is invalid.                                                              | Memory information could not be acquired from the Java VM to be monitored.<br><br>%1: Name of the Java VM to be monitored                                                                                                                                                                                                                               | Check whether the operating environment of the Java VM to be monitored is correct.                                                                                  |
| %1: Failed to measure the memory stat.                                                    | Memory information could not be acquired from the Java VM to be monitored.<br><br>%1: Name of the Java VM to be monitored                                                                                                                                                                                                                               | Check whether the operating environment of the Java VM to be monitored is correct.<br><br>Check whether the processing load is high in the Java VM to be monitored. |
| %1: MemoryPool name is undefined. memory_name = %2.                                       | Memory information could not be acquired from the Java VM to be monitored.<br><br>%1: Name of the Java VM to be monitored<br><br>%2: Name of the Java memory pool to be measured                                                                                                                                                                        | Check whether the operating environment of the Java VM to be monitored is correct.                                                                                  |
| %1: MemoryPool capacity is too little. memory_name = %2, used = %3, max = %4, ratio = %5. | The Java memory pool free space has fallen below the threshold in the Java VM to be monitored.<br><br>%1: Name of the Java VM to be monitored<br><br>%2: Name of the Java memory pool to be measured<br><br>%3: Use amount of the Java memory pool<br><br>%4: Maximum usable amount of the Java memory pool<br><br>%5: Use rate of the Java memory pool | Review the Java application that runs on the Java VM to be monitored.                                                                                               |

| Message                                   | Cause of generation                                                                                                                                                                         | Action                                                                                                             |
|-------------------------------------------|---------------------------------------------------------------------------------------------------------------------------------------------------------------------------------------------|--------------------------------------------------------------------------------------------------------------------|
| %1: THREAD_MXBEAN_NAME is invalid.        | Thread information could not be acquired from the Java VM to be monitored.<br><br>%1: Name of the Java VM to be monitored                                                                   | Check whether the operating environment of the Java VM to be monitored is correct.                                 |
| %1: ThreadMXBean is invalid.              | Thread information could not be acquired from the Java VM to be monitored.<br><br>%1: Name of the Java VM to be monitored                                                                   | Check whether the operating environment of the Java VM to be monitored is correct.                                 |
| %1: Failed to measure the thread stat.    | Thread information could not be acquired from Java VM to be monitored.<br><br>%1: Name of the Java VM to be monitored                                                                       | Check whether the operating environment of the Java VM to be monitored is correct.                                 |
| %1: Detect Deadlock. threads = %2.        | Thread deadlock has occurred in the Java VM to be monitored.<br><br>%1: Name of the Java VM to be monitored<br>%2: ID of the deadlock thread                                                | Review the Java application that runs on the Java VM to be monitored.                                              |
| %1: Thread count is too much(%2).         | The number of activated threads has exceeded the threshold in the Java VM to be monitored.<br><br>%1: Name of the Java VM to be monitored<br>%2: Number of activated threads at measurement | Review the Java application that runs on the Java VM to be monitored.                                              |
| %1: ThreadInfo is null.Thread count = %2. | Thread information could not be acquired in the Java VM to be monitored.<br><br>%1: Name of the Java VM to be monitored<br>%2: Number of activated threads at measurement                   | Check whether the operating environment of the version of the Java VM to be monitored is correct.                  |
| %1: Failed to disconnect.                 | Disconnection from the Java VM to be monitored has failed.<br><br>%1: Name of the Java VM to be monitored                                                                                   | -                                                                                                                  |
| %1: Failed to connect to WebLogicServer.  | WebLogic Server to be monitored could not be connected.<br><br>%1: Name of the Java VM to be monitored                                                                                      | Review the Java application that runs on the WebLogic Server to be monitored.                                      |
| %1: Failed to connect to Sun JVM.         | Java VM and WebOTX to be monitored could not be connected.<br><br>%1: Name of the Java VM to be monitored                                                                                   | Review the Java application that runs on the Java VM and WebOTX to be monitored.                                   |
| Failed to open the %1.                    | The JVM statistics log could not be output.<br><br>%1: Name of the HA/JVMSaverJVM statistics log file                                                                                       | Check whether the disk has sufficient free space or whether the number of open files has exceeded the upper limit. |

| Message                                                                  | Cause of generation                                                                                                                                                                                                                                                     | Action                                                                                                    |
|--------------------------------------------------------------------------|-------------------------------------------------------------------------------------------------------------------------------------------------------------------------------------------------------------------------------------------------------------------------|-----------------------------------------------------------------------------------------------------------|
| %1: Can't find monitor file.                                             | No monitoring<br>%1: Name of the Java VM to be monitored                                                                                                                                                                                                                | -                                                                                                         |
| %1: Can't find monitor file, monitor stopped[thread:%2].                 | Monitoring stops.<br>%1: Name of the Java VM to be monitored<br>%2: Type of the measurement thread                                                                                                                                                                      | -                                                                                                         |
| %1: Failed to create monitor status file.                                | An internal file could not be created.<br>%1: Name of the Java VM to be monitored                                                                                                                                                                                       | Check whether the disk free space and the maximum number of volume files are sufficient.                  |
| %1: Failed to delete monitor status file.                                | An internal file could not be deleted.<br>%1: Name of the Java VM to be monitored                                                                                                                                                                                       | Check whether there is a problem with the hard disk.                                                      |
| %1: com.bea.Type=ServerRuntime is invalid.                               | Information could not be acquired from the Java VM to be monitored.<br>%1: Name of the Java VM to be monitored                                                                                                                                                          | Check whether the operating environment of the Java VM to be monitored is correct.                        |
| %1: WorkManagerRuntimeMBean or ThreadPoolRuntimeMBean is invalid.        | Information could not be acquired from the WebLogic Server to be monitored.<br>%1: Name of the Java VM to be monitored                                                                                                                                                  | Check whether the operating environment of the WebLogic Server to be monitored is correct.                |
| %1: Failed to measure the WorkManager or ThreadPool stat.                | Information could not be acquired from the WebLogic Server to be monitored.<br>%1: Name of the Java VM to be monitored                                                                                                                                                  | Check whether the operating environment of the WebLogic Server to be monitored is correct.                |
| %1: ThreadPool stat is invalid.<br>last.pending = %2, now.pending = %3.  | The number of waiting requests could not be measured in the thread pool of the WebLogic Server to be monitored.<br>%1: Name of the Java VM to be monitored<br>%2: Number of waiting requests at last measurement<br>%3: Number of waiting requests at this measurement  | Check whether the operating environment of the version of the WebLogic Server to be monitored is correct. |
| %1: WorkManager stat is invalid.<br>last.pending = %2, now.pending = %3. | The number of waiting requests could not be measured in the work manager of the WebLogic Server to be monitored.<br>%1: Name of the Java VM to be monitored<br>%2: Number of waiting requests at last measurement<br>%3: Number of waiting requests at this measurement | Check whether the operating environment of the version of the WebLogic Server to be monitored is correct. |

| Message                                                                                                                          | Cause of generation                                                                                                                                                                                                                                                                                                                                                                                                                                                             | Action                                                                        |
|----------------------------------------------------------------------------------------------------------------------------------|---------------------------------------------------------------------------------------------------------------------------------------------------------------------------------------------------------------------------------------------------------------------------------------------------------------------------------------------------------------------------------------------------------------------------------------------------------------------------------|-------------------------------------------------------------------------------|
| %1: PendingRequest count is too much. count = %2.                                                                                | <p>The number of waiting requests has exceeded the threshold in the thread pool of the WebLogic Server to be monitored.</p> <p>%1: Name of the Java VM to be monitored</p> <p>%2: Number of waiting requests at this measurement</p>                                                                                                                                                                                                                                            | Review the Java application that runs on the WebLogic Server to be monitored. |
| %1: PendingRequest increment is too much. increment = %4, last.pending = %2, now.pending = %3.                                   | <p>The increment of the number of waiting requests has exceeded the threshold in the thread pool of the WebLogic Server to be monitored.</p> <p>%1: Name of the Java VM to be monitored</p> <p>%2: Number of waiting requests at last measurement</p> <p>%3: Number of waiting requests at this measurement</p> <p>%4: Increment of the number of waiting requests from the last measurement to this measurement</p>                                                            | Review the Java application that runs on the WebLogic Server to be monitored. |
| %1: PendingRequest increment is too much compared with the last connection. increment = %4, last.pending = %2, now.pending = %3. | <p>After the WebLogic Server to be monitored was reconnected, the increment of the number of waiting requests has exceeded the threshold in the thread pool of the WebLogic Server to be monitored.</p> <p>%1: Name of the Java VM to be monitored</p> <p>%2: Number of waiting requests at last measurement</p> <p>%3: Number of waiting requests at this measurement</p> <p>%4: Increment of the number of waiting requests from the last measurement to this measurement</p> | Review the Java application that runs on the WebLogic Server to be monitored. |
| %1: Throughput count is too much. count = %2.                                                                                    | <p>The number of requests executed per unit time has exceeded the threshold in the thread pool of the WebLogic Server to be monitored.</p> <p>%1: Name of the Java VM to be monitored</p> <p>%2: Number of requests executed per unit time at this measurement</p>                                                                                                                                                                                                              | Review the Java application that runs on the WebLogic Server to be monitored. |



| Message                                                                                                                                   | Cause of generation                                                                                                                                                                                                                                                                                                                                                                                                                                                                                                                         | Action                                                                               |
|-------------------------------------------------------------------------------------------------------------------------------------------|---------------------------------------------------------------------------------------------------------------------------------------------------------------------------------------------------------------------------------------------------------------------------------------------------------------------------------------------------------------------------------------------------------------------------------------------------------------------------------------------------------------------------------------------|--------------------------------------------------------------------------------------|
| <p>%1: Throughput increment is too much. increment = %4, last.throughput = %2, now.throughput = %3.</p>                                   | <p>The increment of the number of requests executed per unit time has exceeded the threshold in the thread pool of the WebLogic Server to be monitored.</p> <p>%1: Name of the Java VM to be monitored</p> <p>%2: Number of requests executed per unit time at last measurement</p> <p>%3: Number of requests executed per unit time at this measurement</p> <p>%4: Increment of the number of requests executed per unit time from the last measurement to this measurement</p>                                                            | <p>Review the Java application that runs on the WebLogic Server to be monitored.</p> |
| <p>%1: Throughput increment is too much compared with the last connection. increment = %4, last.throughput = %2, now.throughput = %3.</p> | <p>After the WebLogic Server to be monitored was reconnected, the increment of the number of requests executed per unit time has exceeded the threshold in the thread pool of the WebLogic Server to be monitored.</p> <p>%1: Name of the Java VM to be monitored</p> <p>%2: Number of requests executed per unit time at last measurement</p> <p>%3: Number of requests executed per unit time at this measurement</p> <p>%4: Increment of the number of requests executed per unit time from the last measurement to this measurement</p> | <p>Review the Java application that runs on the WebLogic Server to be monitored.</p> |
| <p>%1: PendingRequest count is too much. appName = %2, name = %3, count = %4.</p>                                                         | <p>The number of waiting requests has exceeded the threshold in the work manager of the WebLogic Server to be monitored.</p> <p>%1: Name of the Java VM to be monitored</p> <p>%2: Application name</p> <p>%3: Work manager name</p> <p>%4: Number of waiting requests</p>                                                                                                                                                                                                                                                                  | <p>Review the Java application that runs on the WebLogic Server to be monitored.</p> |

| Message                                                                                                                                                   | Cause of generation                                                                                                                                                                                                                                                                                                                                                                                                                                                                                                                       | Action                                                                        |
|-----------------------------------------------------------------------------------------------------------------------------------------------------------|-------------------------------------------------------------------------------------------------------------------------------------------------------------------------------------------------------------------------------------------------------------------------------------------------------------------------------------------------------------------------------------------------------------------------------------------------------------------------------------------------------------------------------------------|-------------------------------------------------------------------------------|
| %1: PendingRequest increment is too much. appName = %2, name = %3, increment = %6, last.pending = %4, now.pending = %5.                                   | <p>The increment of the number of waiting requests has exceeded the threshold in the work manager of the WebLogic Server to be monitored.</p> <p>%1: Name of the Java VM to be monitored</p> <p>%2: Application name</p> <p>%3: Work manager name</p> <p>%4: Number of waiting requests at last measurement</p> <p>%5: Number of waiting requests at this measurement</p> <p>%6: Increment of the number of waiting requests from the last measurement to this measurement</p>                                                            | Review the Java application that runs on the WebLogic Server to be monitored. |
| %1: PendingRequest increment is too much compared with the last connection. AppName = %2, Name = %3, increment = %6, last.pending = %4, now.pending = %5. | <p>After the WebLogic Server to be monitored was reconnected, the increment of the number of waiting requests has exceeded the threshold in the work manager of the WebLogic Server to be monitored.</p> <p>%1: Name of the Java VM to be monitored</p> <p>%2: Application name</p> <p>%3: Work manager name</p> <p>%4: Number of waiting requests at last measurement</p> <p>%5: Number of waiting requests at this measurement</p> <p>%6: Increment of the number of waiting requests from the last measurement to this measurement</p> | Review the Java application that runs on the WebLogic Server to be monitored. |
| %1: Can't find WorkManager. appName = %2, name = %3.                                                                                                      | <p>The work manager which was set could not be acquired from the WebLogic Server.</p> <p>%1: Name of the Java VM to be monitored</p> <p>%2: Application name</p> <p>%3: Work manager name</p>                                                                                                                                                                                                                                                                                                                                             | Review the setting of <b>Target WebLogic Work Managers</b> .                  |
| %1: analyze of average start[%2].                                                                                                                         | <p>Analyzing of the average value has started.</p> <p>%1: Name of the Java VM to be monitored</p> <p>%2: Thread name</p>                                                                                                                                                                                                                                                                                                                                                                                                                  | -                                                                             |
| %1: analyze of average finish[%2].state = %3.                                                                                                             | <p>Analyzing of the average value has been completed.</p> <p>%1: Name of the Java VM to be monitored</p> <p>%2: Thread name</p> <p>%3: Status of the target to be monitored</p>                                                                                                                                                                                                                                                                                                                                                           | -                                                                             |

| Message                                                                               | Cause of generation                                                                                                                                                                                                                                                                                    | Action                                                                        |
|---------------------------------------------------------------------------------------|--------------------------------------------------------------------------------------------------------------------------------------------------------------------------------------------------------------------------------------------------------------------------------------------------------|-------------------------------------------------------------------------------|
| %1: Average of PendingRequest count is too much. count = %2.                          | The average of the number of waiting requests has exceeded the threshold in the thread pool of the WebLogic Server to be monitored.<br><br>%1: Name of the Java VM to be monitored<br><br>%2: Number of waiting requests at this measurement                                                           | Review the Java application that runs on the WebLogic Server to be monitored. |
| %1: Average of Throughput count is too high. count = %2.                              | The average of the number of requests executed per unit time has exceeded the threshold in the thread pool of the WebLogic Server to be monitored.<br><br>%1: Name of the Java VM to be monitored<br><br>%2: Number of requests executed per unit time at this measurement                             | Review the Java application that runs on the WebLogic Server to be monitored. |
| %1: Average of PendingRequest count is too high. AppName = %2, Name = %3, count = %4. | The average of the number of waiting requests has exceeded the threshold in the work manager of the WebLogic Server to be monitored.<br><br>%1: Name of the Java VM to be monitored<br><br>%2: Application name<br><br>%3: Work manager name<br><br>%4: Number of waiting requests at this measurement | Review the Java application that runs on the WebLogic Server to be monitored. |
| Error: Failed to operate clpjra_bigip.[%1\$s]                                         | %1\$s: Error code                                                                                                                                                                                                                                                                                      | Review the setting.                                                           |

## JVM load balancer linkage log

| Message                          | Cause of generation                                                                        | Action |
|----------------------------------|--------------------------------------------------------------------------------------------|--------|
| lbadm command start.             | Execution of the load balancer linkage command has started.                                | -      |
| lbadm command finish.            | Execution of the load balancer linkage command has been completed.                         | -      |
| Into HealthCheck mode.           | The health check function is enabled.                                                      | -      |
| Into Weight mode.                | The load calculation function of the Java VM to be monitored is valid.                     | -      |
| The PID of lbadm.jar is "%1".    | ID of the process relating to the load balancer linkage<br><br>%1: Process ID of lbadm.jar | -      |
| Thread wait stopped by Exception | Waiting for down judgment has been stopped.                                                | -      |

| Message                                                                   | Cause of generation                                                                                          | Action                                                                                                                       |
|---------------------------------------------------------------------------|--------------------------------------------------------------------------------------------------------------|------------------------------------------------------------------------------------------------------------------------------|
| Rename Command succeeded.                                                 | Renaming of the HTML file has been successful.                                                               | -                                                                                                                            |
| Rename Command failed.                                                    | Renaming of the HTML file has failed.                                                                        | Check the HTML file name and HTML rename destination file name.                                                              |
| %1 doesn't exist.                                                         | The rename source HTML file does not exist.<br>%1: HTML file name                                            | Check the HTML file name.                                                                                                    |
| %1 already exists.                                                        | The rename destination HTML file already exists.<br>%1: HTML rename destination file name                    | Check the HTML rename destination file name.                                                                                 |
| Can't rename file:%1.                                                     | Renaming of the HTML file has failed.<br>%1: HTML file name                                                  | Check the HTML rename destination file name.                                                                                 |
| The number of retries exceeded the limit.                                 | The retry count for renaming the HTML file has exceeded the upper limit.                                     | Check the HTML rename destination file name.                                                                                 |
| The percent of the load is "%1".                                          | Load calculation for the Java VM to be monitored has been successful.<br>%1: Load of Java VM to be monitored | -                                                                                                                            |
| stat log (%1) doesn't exist.                                              | There is no JVM statistics log file.<br>%1: JVM statistics log file name                                     | Execute cluster suspend/cluster resume and then restart the Java Resource Agent.                                             |
| stat log(%1:) cannot be opened for reading.                               | The JVM statistics log file could not be opened.<br>%1: JVM statistics log file name                         | Execute cluster suspend/cluster resume and then restart the Java Resource Agent.                                             |
| format of stat log (%1) is wrong.                                         | The contents of the JVM statistics log file are invalid.<br>%1: Statistics log file name                     | After deleting the JVM statistics log file, execute cluster suspend/cluster resume and then restart the Java Resource Agent. |
| Failed to get load of application server.                                 | Data for load calculation could not be acquired from the JVM statistics log file.                            | Review whether the load calculation setting of the Java VM to be monitored is correct.                                       |
| Can't find lock file(%1s*.stat.lck), maybe HA/JVMSaver did not start yet. | JVM monitoring has not yet started.<br>%1: Internal file name                                                | Start the JVM monitoring.                                                                                                    |

## STOP codes list of user space monitor resources

The following information is a list of the STOP error codes which are generated upon the selection of **Generate an intentional stop error** for **Action When Timeout Occurs** of the user space monitor resource.

| STOP code  | Description                                                                                                                                                                                                                          |
|------------|--------------------------------------------------------------------------------------------------------------------------------------------------------------------------------------------------------------------------------------|
| 0xE0000000 | The STOP error which was generated as the final action upon the detection of an error of the monitor resource                                                                                                                        |
| 0xE000FF** | The STOP error which was generated by keep alive timeout (the timeout of user space monitor)<br>The lower 8 bits (the part of "**") shows the following checkpoint (The chances are high that it was being executed during timeout). |
| 0xE000FF00 | The internal processing of EXPRESSCLUSTER                                                                                                                                                                                            |
| 0xE000FF01 | SetWaitableTimer(), GetTickCount(), WaitForMultipleObjects()                                                                                                                                                                         |
| 0xE000FF02 | _beginthreadex(), WaitForMultipleObjects()                                                                                                                                                                                           |
| 0xE000FF05 | CloseHandle()                                                                                                                                                                                                                        |
| 0xE000FF06 | The internal processing of EXPRESSCLUSTER                                                                                                                                                                                            |



# Appendix

This section covers:

- Appendix A      Glossary
- Appendix B      Index





# Appendix A Glossary

|                                 |                                                                                                                                                                                                                     |
|---------------------------------|---------------------------------------------------------------------------------------------------------------------------------------------------------------------------------------------------------------------|
| <b>Active server</b>            | A server that is running for an application set.<br>(Related term: Standby server)                                                                                                                                  |
| <b>C heap</b>                   | Memory area used by Java VM itself                                                                                                                                                                                  |
| <b>Cluster partition</b>        | A partition on a mirror disk. Used for managing mirror disks.<br>(Related term: Disk heartbeat partition)                                                                                                           |
| <b>Cluster shutdown</b>         | To shut down an entire cluster system (all servers that configure a cluster system).                                                                                                                                |
| <b>Cluster system</b>           | Multiple computers are connected via a LAN (or other network) and behave as if it were a single system.                                                                                                             |
| <b>Data partition</b>           | A local disk that can be used as a shared disk for switchable partition. Data partition for mirror disks.<br>(Related term: Cluster partition)                                                                      |
| <b>Disk heartbeat partition</b> | A partition used for heartbeat communication in a shared disk type cluster.                                                                                                                                         |
| <b>Failback</b>                 | A process of returning an application back to an active server after an application fails over to another server.                                                                                                   |
| <b>Failover</b>                 | The process of a standby server taking over the group of resources that the active server previously was handling due to error detection.                                                                           |
| <b>Failover group</b>           | A group of cluster resources and attributes required to execute an application.                                                                                                                                     |
| <b>Failover policy</b>          | A priority list of servers that a group can fail over to.                                                                                                                                                           |
| <b>Floating IP address</b>      | Clients can transparently switch one server from another when a failover occurs.<br>Any unassigned IP address that has the same network address that a cluster server belongs to can be used as a floating address. |
| <b>GC</b>                       | Abbreviation for garbage collection                                                                                                                                                                                 |
| <b>Heartbeat</b>                | Signals that servers in a cluster send to each other to detect a failure in a cluster.<br>(Related terms: Interconnect, Network partition)                                                                          |
| <b>Interconnect</b>             | A dedicated communication path for server-to-server communication in a cluster.<br>(Related terms: Private LAN, Public LAN)                                                                                         |
| <b>Java heap</b>                | Area in which the Java VM allocates memory according to a memory acquisition request from a Java application.<br>Target of GC                                                                                       |

|                                      |                                                                                                                                                                                                                                |
|--------------------------------------|--------------------------------------------------------------------------------------------------------------------------------------------------------------------------------------------------------------------------------|
| <b>Java memory pool</b>              | Memory area prepared by the Java VM for Java applications                                                                                                                                                                      |
| <b>JMX</b>                           | Abbreviation for Java Management Extensions. Specification used for Java that manages and monitors the hardware and software in the network                                                                                    |
| <b>JVM load balancer linkage log</b> | File for recording the load balancer linkage operation information obtained from JVM monitoring. The file is created in the following location:<br>Windows version:<br><EXPRESSCLUSTER_install_path>\log\ha\jra\lbadmin.log    |
| <b>JVM operation log</b>             | File for recording JVM monitoring operation information. The file is created in the following location:<br>Windows version:<br><EXPRESSCLUSTER_install_path>\log\ha\jra\jrgent*.log<br>* (* indicates a number starting at 0.) |
| <b>JVM statistics log</b>            | File for recording statistics obtained from JVM monitoring. The file is created in the following location:<br>Windows version:<br><EXPRESSCLUSTER_install_path>\log\ha\jra\*.stat                                              |
| <b>Management client</b>             | Any machine that uses the WebManager to access and manage a cluster system.                                                                                                                                                    |
| <b>Master server</b>                 | Server displayed on top of the <b>Master Server</b> in <b>Server Common Properties</b> in the Builder                                                                                                                          |
| <b>Mirror connect</b>                | LAN used for data mirroring in a data mirror type cluster. Mirror connect can be used with primary interconnect.                                                                                                               |
| <b>Mirror disk type cluster</b>      | A cluster system that does not use a shared disk. Local disks of the servers are mirrored.                                                                                                                                     |
| <b>Moving failover group</b>         | Moving an application from an active server to a standby server by a user.                                                                                                                                                     |
| <b>Network partition</b>             | All heartbeat is lost and the network between servers is partitioned.<br>(Related terms: Interconnect, Heartbeat)                                                                                                              |
| <b>Node</b>                          | A server that is part of a cluster in a cluster system. In networking terminology, it refers to devices, including computers and routers, that can transmit, receive, or process signals.                                      |
| <b>Primary (server)</b>              | A server that is the main server for a failover group.<br>(Related term: Secondary server)                                                                                                                                     |
| <b>Private LAN</b>                   | LAN in which only servers configured in a clustered system are connected.<br>(Related terms: Interconnect, Public LAN)                                                                                                         |

---

|                                 |                                                                                                                                               |
|---------------------------------|-----------------------------------------------------------------------------------------------------------------------------------------------|
| <b>Public LAN</b>               | A communication channel between clients and servers.<br>(Related terms: Interconnect, Private LAN)                                            |
| <b>Secondary server</b>         | A destination server where a failover group fails over to during normal operations.<br>(Related term: Primary server)                         |
| <b>Server Group</b>             | A group of servers connected to the same network or the shared disk device                                                                    |
| <b>Shared disk</b>              | A disk that multiple servers can access.                                                                                                      |
| <b>Shared disk type cluster</b> | A cluster system that uses one or more shared disks.                                                                                          |
| <b>Standby server</b>           | A server that is not an active server.<br>(Related term: Active server)                                                                       |
| <b>Startup attribute</b>        | A failover group attribute that determines whether a failover group should be started up automatically or manually when a cluster is started. |
| <b>Switchable partition</b>     | A disk partition connected to multiple computers and is switchable among computers.<br>(Related terms: Disk heartbeat partition)              |
| <b>Virtual IP address</b>       | IP address used to configure a remote cluster.                                                                                                |



# Appendix B Index

## A

- Account tab, 181
- Activation and deactivation error of recovery target, 771
- Adding a cluster**, 1103
- Adding an object, 133
- Adding servers**, 1103
- Adjusting time-out temporarily, 372
- alert message, 1090
- Alert Log tab, 174
- alert message, 1091
- Alert Service tab, 159
- Alert view fields, 81
- Alert view operation, 81
- Application monitor resource, 1258
- application monitor resources, 804
- Application resource, 1244
- application resources, 576
- Application resources, 576
- Apply the configuration file, 126
- appropriate use of virtual computer name resources and dynamic DNS resources, 668, 677
- Auto Recovery tab, 183
- Automatically recovering from mirroring, 1187
- AWS AZ monitor resource, 1290, 1048
- AWS elastic ip monitor resource, 1289, 1040
- AWS elastic ip resource, 1255
- AWS elastic ip resources, 723, 725
- AWS virtual ip monitor resource, 1289, 1044
- AWS virtual ip resource, 1256
- AWS virtual ip resources, 729, 731
- Azure load balance monitor resource, 1291, 1056
- Azure probe port monitor resource, 1290, 1052
- Azure probe port resource, 1257, 735
- Azure probe port resources, 735
- Azure probe port resources, Azure probe port monitor resources, Azure load balance monitor resources, 1109
- Azure probe resource, 737

## B

- backing up configuration data, 255, 364
- Backing up the cluster configuration data, 369
- Behavior of reporting icon, 1091
- Behavior when an error is detected by a monitor resource, 755
- BMC heartbeat resources, 1063
- BMC tab, 205

## C

- Changing the name of a monitor resource, 792
- Changing the screen layout, 37
- Checking alerts, 27, 30, 31, 80, 419
- Checking the cluster status, 27, 30, 72
- Checking the mirror break status from the

- WebManager, 1193
- Checking the mirror break status with a command, 1188
- Checking the mirror recovery progress from the WebManager, 1194
- Checking the mirror recovery progress with a command, 1189
- Checking the status of each object, 27, 30, 41
- Checking the status of individual server in the WebManager list view, 79
- Checking the status of the whole monitor in the WebManager list view, 79
- Checking the time information, 37
- Checking the version information, 136
- Checking the whole status of the server, 78
- checkingthe process health, 255, 458
- CIFS monitor resource, 1258
- CIFS resource, 1244
- CIFS resources, 696
- Cluster shutdown, 98
- Cluster shutdown reboot, 98
- Collecting information when a failure occurs, 363
- Collecting logs, 34, 149, 255, 357
- Collecting logs by specifying a type, 360
- Collecting logs by using the WebManager, 34
- COM network partition resolution resources, 1069
- Command that displays status**, 263
- Communication ports, 1132
- Config Mode, 132
- Configuration and range of NIC link up/down monitoring, 828
- Configuring the settings to temporarily prevent execution of failover, 1140
- Connecting mirror disks manually, 1185
- Consideration for using the Builder, 111
- Considerations for service resources, 655
- Controlling group resources, 255, 429
- Controlling monitor resources, 255, 421
- Controlling path, 684
- CPU frequency control, 435, 437
- CPU usage, 1028, 1034
- Creating a cluster, 126, 127, 255, 364, 1103
- Creating a group**, 1104
- Creating a monitor resource**, 1104
- Creating a new cluster, 124
- Creating cluster configuration information, 1100, 1102
- Custom monitor resource, 1264

## D

- DB2 monitor resource, 1259
- Delay warning of monitor resources, 783
- Delay Warning tab, 176
- dependencies of AWS elastic ip resources, 723
- dependencies of AWS virtual ip resources, 729
- dependencies of Azure probe port resources, 735
- Dependencies of CIFS resources, 696
- Dependencies of disk resource, 650
- Dependencies of floating IP resource, 585

- Dependencies of hybrid disk resources, 709
- Dependencies of mirror disk resource, 592
- Dependencies of NAS resources, 705
- Dependencies of print spooler resources, 661
- Dependencies of registry synchronization resources, 610
- Dependencies of script resources, 616
- Dependencies of service resources, 655
- Dependencies of virtual computer name resources, 666
- Dependencies of virtual IP resources, 682
- Dependencies of VM resources, 718
- dependency on dynamic DNS resources, 675
- Detailed info in activating and deactivating group resources, 1244
- Detailed information at monitor resource error, 1292
- Detailed information of monitor resource errors, 1258
- Details on the Builder screen, 113
- Determining virtual IP address, 684
- Directory structure of EXPRESSCLUSTER, 1118
- Disk filter driver, 1240
- DISK network partition resolution resources, 1072
- Disk resource, 1250
- Disk resources, 650
- Disk RW monitor resource, 1260
- disk RW monitor resources, 806
- Disk tab, 177
- Disk TUR monitor resource, 1278
- disk TUR monitor resources, 839
- Displaying a group map**, 265
- Displaying all cluster configuration data**, 338
- Displaying and changing disk RW monitor resource details, 807
- Displaying and changing floating IP monitor resource details, 812
- Displaying and changing IP monitor resource details, 816
- Displaying and changing Logical Service, 554
- Displaying and changing NAS resources, 706
- Displaying and changing the application resource details, 577
- Displaying and changing the comment of a group, 546, 573
- Displaying and changing the comment of a group resource, 561
- Displaying and changing the comment of a monitor resource, 792
- Displaying and changing the details of CIFS monitor resources, 858
- Displaying and changing the details of CIFS resources, 699
- Displaying and changing the details of disk resource, 656
- Displaying and changing the details of disk resources, 652
- displaying and changing the details of dynamic DNS resources, 678
- Displaying and changing the details of floating IP resource, 588
- Displaying and changing the details of hybrid disk resource, 712
- Displaying and changing the details of mirror disk resource, 602
- Displaying and changing the details of NAS monitor resources, 862
- Displaying and changing the details of print spooler resources, 663
- Displaying and changing the details of registry synchronization resources, 612
- Displaying and changing the details of the multi target monitor resource, 833
- Displaying and changing the details of the registry synchronization monitor resources, 837
- Displaying and changing the details of the service monitor resources, 843
- Displaying and changing the details of the virtual computer name resources, 848
- Displaying and changing the details of the virtual IP monitor resources, 855
- Displaying and changing the details of virtual computer name resource, 672
- Displaying and changing the details of virtual IP resource, 687
- Displaying and changing the details of VM resources, 719
- Displaying and changing the disk DB2 monitor resource details, 893
- Displaying and changing the disk TUR monitor resource details, 840
- Displaying and changing the FTP monitor resource details, 897
- Displaying and changing the group attribute, 549
- Displaying and changing the HTTP monitor resource details, 901
- Displaying and changing the hybrid disk monitor resource details, 865
- Displaying and changing the hybrid disk TUR monitor resource details, 869
- Displaying and changing the IMAP4 monitor resource details, 905
- displaying and changing the JVM monitor resource details, 1003
- Displaying and changing the mirror connect monitor resource details, 820
- Displaying and changing the mirror disk monitor resource details, 824
- Displaying and changing the NIC link up/down monitor resource details, 828
- Displaying and changing the ODBC monitor resource details, 910
- Displaying and changing the operation settings when a group resource error is detected, 522, 565
- Displaying and changing the Oracle monitor resource details, 915
- Displaying and changing the OracleAS monitor resource details, 923
- Displaying and changing the OracleAS monitor resource properties, 925
- Displaying and changing the POP3 monitor resource details, 933
- Displaying and changing the PostgreSQL monitor resource details, 938
- Displaying and changing the process name monitor resource details, 888
- Displaying and changing the script resource details, 640
- Displaying and changing the script resource script

---

created by the Builder, 645

Displaying and changing the server group settings, 573

Displaying and changing the settings of a group, 574

Displaying and changing the settings of a monitor resource, 793

Displaying and changing the settings of group properties, 546

Displaying and changing the settings of group resources, 561

Displaying and changing the settings of servers that starts up the group, 546

Displaying and changing the settings of the script resource details, 640

Displaying and changing the settings when an error is detected by a monitor resource, 522, 797, 803

Displaying and changing the SMTP monitor resource details, 944

Displaying and changing the SQL Server monitor resource details, 950

Displaying and changing the system monitor resource details, 1025

Displaying and changing the Tuxedo monitor resource details, 955

Displaying and changing the Weblogic monitor resource details, 964

Displaying and changing the WebOTX monitor resource details, 969

Displaying and changing the Websphere monitor resource details, 958

Displaying and configuring the settings of dependency among group resources, 563

Displaying and setting group start dependence and group stop dependence, 557

Displaying and/or changing the script resource script created by the Builder, 642

displaying AWS elastic ip monitor resource properties, 1041

displaying AWS virtual ip monitor resource properties, 1046

displaying Azure load balance monitor resource properties, 1057

displaying Azure probe port resource properties, 738

Displaying CIFS monitor resource properties with the WebManager, 860

Displaying CIFS resource properties with the WebManager, 703

displaying dynamic DNS monitor resource properties with WebManager, 852

displaying dynamic DNS resource properties, 680

Displaying hybrid disk resource properties with the WebManager, 715

Displaying NAS monitor resources properties with the WebManager, 863

Displaying NAS resource properties with the WebManager, 707

**Displaying only the configuration data of a certain group resource, 284**

**Displaying only the configuration data of certain groups, 282**

**Displaying only the configuration data of certain server groups, 281**

**Displaying only the configuration data of certain servers, 276, 279**

**Displaying only the data of a certain monitor resource, 309**

**Displaying only the resource information of certain heartbeats, 277**

Displaying the application monitor resource properties with the WebManager, 804

Displaying the application resource properties with the WebManager, 582

displaying the AWS AZ monitor resource properties, 1049

displaying the Azure probe port monitor resource properties, 1053

**Displaying the cluster configuration data, 270**

Displaying the cluster status, 255, 259

Displaying the disk resource properties with the WebManager, 653

Displaying the disk RW monitor resource properties with the WebManager, 809

Displaying the disk TUR monitor resources properties with the WebManager, 841

Displaying the floating IP monitor resource properties with the WebManager, 813

Displaying the FTP monitor resource properties, 898

Displaying the HTTP monitor resource properties, 902

Displaying the hybrid disk monitor resource properties with the WebManager, 867

Displaying the hybrid disk TUR monitor resources properties with the WebManager, 871

Displaying the IMAP4 monitor resource properties, 906

Displaying the IP monitor resource properties with the WebManager, 818

Displaying the JVM monitor resource properties, 1017

Displaying the mirror connect monitor resource properties with the WebManager, 822

Displaying the mirror disk monitor resource properties with the WebManager, 826

Displaying the mirror disk resource properties with the WebManager, 607

Displaying the NIC link up/down monitor resource properties with the WebManager, 830

Displaying the ODBC monitor resource properties, 911

Displaying the Oracle monitor resource properties, 919

Displaying the POP3 monitor resource properties, 934

Displaying the PostgreSQL monitor resource properties, 940

Displaying the print spooler monitor resources properties with the WebManager, 846

Displaying the print spooler resource properties with the WebManager, 664

Displaying the process name monitor resource properties, 889

Displaying the properties of BMC heartbeat resources, 1063

Displaying the properties of COM network partition resolution resources with the WebManager, 1070

Displaying the properties of DISK network partition resolution resources with the WebManager, 1073

Displaying the properties of floating IP resource with the WebManager, 590  
 Displaying the properties of kernel mode LAN heartbeat resources with the WebManager, 1062  
 Displaying the properties of majority network partition resolution resources with the WebManager, 1077  
 Displaying the properties of PING network partition resolution resources with the WebManager, 1075  
 Displaying the properties of the multi target monitor resource with the WebManager, 835  
 Displaying the property of a certain group by using the WebManager, 571  
 displaying the property of the AWS virtual ip resource with the WebManager, 733  
 Displaying the property of the whole groups by using the WebManager, 570  
 Displaying the registry synchronization monitor resources properties with the WebManager, 837  
 Displaying the registry synchronization resource properties with the WebManager, 615  
 Displaying the script resource properties with the WebManager, 648  
 Displaying the server group properties, 575  
 Displaying the service monitor resources properties with the WebManager, 844  
 Displaying the service resource properties with the WebManager, 659  
 Displaying the SMTP monitor resource properties, 946  
 Displaying the SQL Server monitor resource properties, 952  
**Displaying the status of heartbeat resources,** 268  
**Displaying the status of monitor resources,** 266  
**Displaying the status of network partition resolution resources,** 269  
**Displaying the status of the cluster,** 339  
 Displaying the system monitor resource properties, 1032  
 Displaying the Tuxedo monitor resource properties, 956  
 Displaying the virtual computer name monitor resource properties with the WebManager, 849  
 Displaying the virtual computer name resource properties with the WebManager, 674  
 Displaying the virtual IP monitor resource properties with the WebManager, 855  
 Displaying the virtual IP resource properties with the WebManager, 694  
 Displaying the VM resource properties with the WebManager, 721  
 Displaying the Weblogic monitor resource properties, 966  
 Displaying the WebOTX monitor resource properties, 970  
 Displaying the Websphere monitor resource properties, 960  
 Driver event log messages, 1240  
 Duration Time, 247, 1028  
 dynamic DNS monitor resources, 851  
 Dynamic DNS monitoring resource, 1286  
 Dynamic DNS resource, 1254  
 dynamic DNS resources, 675, 676

## E

Edit menu, 133  
 Emergency cluster shutdown, 1138  
 Emergency server restart, 1139  
 Enabling and disabling Dummy failure of monitor resources, 749  
 environment variable, 536  
 environment variables, 779  
 Environment variables in script of script resource, 618  
 Error messages of the WebManager, 100  
 Estimating the amount of resource usage, 453  
 example, 1111  
 Examples of mirror disk construction, 600  
 Executing command corresponding to cause of each detected error, 995  
 Execution timing of script resource scripts, 620  
 Exiting from the Builder, 131  
 Express5800/A1080a series, 878, 1081, 1099  
 EXPRESSCLUSTER commands, 256

## F

failover policy, 522, 526  
 Failure in resuming the cluster, 1139  
 File menu, 123  
 Final action, 1137, 1138, 535, 566, 567  
 Floating IP, 585  
 Floating IP monitor resource, 1262  
 floating IP monitor resources, 811  
 Floating IP resource, 1245  
 flow of describing a script before final action, 537  
 Forced stop action, 1138  
 Forcibly connecting mirror disk when mirroring is not available, 1185  
 FTP monitor resource, 1263  
 FTP monitor resources, 896

## G

GC operation status check on monitor target Java VM, 988  
 GC tab, 1012  
 Get the configuration file, 126  
 Group resources, 520  
 Group start dependence and group stop dependence, 543

## H

HBA tab, 207  
 Heartbeat resources, 1060  
 Help menu, 136  
 how to delete logs and alerts, 1120  
 How to execute chkdisk/defrag, 1142  
 How to replace a server with a new one, 1117, 1145  
 HTTP monitor resource, 1266  
 HTTP monitor resources, 900  
 Hybrid disk monitor resource, 1266  
 hybrid disk resource, 1246  
 Hybrid disk resource operation command, 414  
 Hybrid disk status display command, 407



---

Hybrid disk TUR monitor resource, 1264  
hybrid disk TUR monitor resources, 869

## I

IMAP4 monitor resource, 1267  
IMAP4 monitor resources, 904  
Info tab, 137, 199  
Information tab, 137, 199  
Inter-cluster processing request command, 442  
Interconnect tab, 138  
IP monitor resource, 1268  
IP monitor resources, 815  
Isolated, 1092

## J

Java memory area usage check on monitor target  
  Java VM, 986  
Java memory pool name, 990  
judgment, 1110  
JVM load balancer linkage log, 1303  
JVM monitor resource, 1286  
JVM monitor resource log output messages, 1293  
JVM monitor resources, 744, 972  
JVM monitor tab, 189  
JVM operation log, 1293  
JVM statistical log, 986

## K

Kernel mode LAN heartbeat driver, 1243

## L

Limit on the band for mirror connect communication,  
  1134  
Limitations of the WebManager, 99  
Limitations on using the Builder, 112  
linking with the load balancer, 977, 979  
Load Balancer, 1015  
Load Balancer Linkage tab(In case of BIG-IP LTM),  
  1016

## M

Mail report, 1090  
Majority network partition resolution resources,  
  1076  
Manually stopping and starting the WebManager,  
  95  
Media sense function becomes invalid, 1198  
Memory tab, 1006, 1008  
Message output command, 419  
Message receive monitor resources, 878  
Messages, 1200, 1201  
Messages during setup, 1200  
Migration tab, 188  
Mirror connect monitor resource, 1269  
Mirror connect monitor resources, 820  
Mirror disk, 592  
Mirror disk helper, 83  
Mirror disk monitor resource, 1268  
Mirror disk monitor resources, 824  
Mirror disk resource, 1246

Mirror disk resource operation command, 395  
mirror disk resources, 714  
Mirror disk resources, 592  
Mirror disk tab, 179  
Mirror parameters, 597  
Mirror related commands, 387  
Mirror statistics information collection function,  
  1121  
Mirror status display commands, 387  
Modifying the log level and size, 375  
monitor resource, 1048, 1052, 1056  
Monitor resources, 743  
Monitor tab, 149  
Monitor timing of monitor resources, 747  
Monitoring, 1035  
Monitoring by application monitor resources, 804  
Monitoring by CIFS monitor resources, 857  
Monitoring by disk RW monitor resources, 806  
Monitoring by floating IP monitor resources, 811  
Monitoring by IP monitor resources, 815  
Monitoring by JVM monitor resources, 972  
Monitoring by NAS monitor resources, 862  
Monitoring by service monitor resources, 843  
Monitoring by system monitor resources, 1021  
Monitoring by virtual computer name monitor  
  resources, 848  
Monitoring by virtual IP monitor resources, 855  
Monitoring duration, 1034  
Monitoring interval for monitor resources, 750  
Monitoring SVF, 1002  
Monitoring Tomcat, 1001  
Monitoring WebLogic Server, 998  
Monitoring WebOTX, 1000  
Multi target monitor resource, 1270  
Multi target monitor resource status, 832  
multi target monitor resources, 832

## N

NAS monitor resource, 1270  
NAS resource, 1247  
NAS resources, 705  
**network configuration**, 1104  
network partition resolution by COM method, 1069  
network partition resolution by COM method and  
  DISK method, 1078  
network partition resolution by DISK method, 651,  
  1071  
network partition resolution by majority method,  
  1076  
network partition resolution by PING method, 1074  
network partition resolution by PING method and  
  DISK method, 1078  
network partition resolution resources, 1066, 1104  
Network Partition Resolution tab, 141  
Network partitions, 1066  
Network warning light switch off command, 434  
NIC Linc Up/Down monitor resource, 1269  
NIC link up/down monitor resources, 828  
Normally connecting mirror disk when mirroring is  
  available, 1185  
Not resolving network partition, 1078  
Note, 832  
Note on application monitor resources, 804  
Note on application resources, 576  
Note on hybrid disk monitor resources, 865

Note on JVM monitor resources, 972  
 Note on mirror connect resources, 820  
 Note on mirror disk monitor resources, 824  
 Note on NAS monitor resources, 862  
 Note on NIC link up/down monitor resources, 828  
 Note on print spooler monitor resources, 846  
 Note on registry synchronization monitor resources, 837  
 Note on service monitor resources, 843  
 notes, 537, 724, 730, 736, 1040, 1044, 1048, 1052, 1056  
 Notes, 1063, 1099, 1106  
 Notes on CIFS monitor resources, 857  
 Notes on CIFS resources, 697  
 Notes on disk resources, 651  
 Notes on disk TUR monitor resources, 839  
 Notes on dynamic DNS monitor resources, 851  
 notes on dynamic DNS resources, 677  
 Notes on floating IP resources, 587  
 Notes on hybrid disk, 710  
 Notes on hybrid disk TUR monitor resources, 869  
 Notes on mirror disk resources, 601  
 Notes on NAS resources, 705  
 Notes on network partition resolution resource settings, 1079  
 Notes on operating hybrid disk resources, 715  
 Notes on operating mirror disk resources, 609  
 Notes on OracleAS monitor resources, 922  
 Notes on print spooler resources, 661  
 Notes on process name monitor resources, 886  
 Notes on registry synchronization resources, 611  
 Notes on system monitor resources, 1019  
 Notes on the kernel mode LAN heartbeat resources, 1061  
 Notes on virtual computer name resources, 668  
 Notes on virtual IP monitor resources, 855  
 Notes on virtual IP resources, 686  
 Notes on VM monitor resources, 884

## O

ODBC monitor resource, 1271  
 ODBC monitor resources, 908  
 OfficeScan CL monitor resource, 1274  
 OfficeScan SV monitor resource, 1274  
 Opening the configuration file, 124  
 Operating a cluster and cluster services, 40  
 Operating a cluster by using the WebManager, 98  
 Operating groups, 255, 351  
 Operating the cluster, 255, 345, 349, 350  
 Operating the cluster from the command line, 256  
 Operation Mode, 132  
 Operation status check on Thread Pool of WebLogic Server, 990  
 Operation status check on Work Manager of WebLogic Server, 989  
 Operations at detection of activation and inactivation errors, 531  
 Oracle monitor resource, 1272  
 Oracle monitor resources, 913  
 OracleAS monitor resource, 1273  
 Output paths of log files, 361  
 Overview of the Builder, 110  
 Overview of the EXPRESSCLUSTER X Builder, 113

## P

Parameter details, 137, 199  
 Parameters list, 209  
 Partition size tuning command, 400  
 PING network partition resolution resource, 1074  
 POP3 monitor resource, 1275  
 POP3 monitor resources, 932  
 Pop-up menu, 121  
 Port No. tab, 147  
 PostgreSQL monitor resource, 1276  
 PostgreSQL monitor resources, 936  
 Power saving tab, 186  
 preparation for use of dynamic DNS resources, 677  
 Print spooler monitor resource, 1279  
 print spooler monitor resources, 846  
 Print spooler resource, 1251  
 print spooler resources, 661  
 Print spooler resources, 661  
 Process name monitor resource, 1270  
 process name monitor resources, 744  
 Process name monitor resources, 886  
 Properties, 135

## R

Reboot count control command, 451  
 Reboot count limit, 538  
 recover mirror (forcefully), 94  
 Recovering a mirror (forcefully), 90  
 Recovering from mirror breaks, 1186  
 Recovering mirror using the WebManager, 1196  
 Recovering mirror with a command, 1190  
 Recovering servers, 98  
 Recovery, 1139  
 Recovery tab, 150  
 Recovery/pre-recovery action script, 779  
 Reference Mode, 132  
 Registering the license, 386  
 Registry synchronization monitor resource, 1277  
 registry synchronization monitor resources, 837  
 Registry synchronization resource, 1248  
 registry synchronization resources, 610  
 Registry synchronization resources, 610  
 Removing an object, 134  
 Renaming a group, 546, 573  
 Renaming a group resource, 561  
 Renaming an object, 135  
 Replacing the hybrid disk, 1167  
 Requirement to use virtual IP address, 685  
 Resetting the reboot count, 542  
 Resource deactivation error, 1139  
 Resuming, suspending, and stopping dummy failure of monitor resources, 98  
 Resuming, suspending, starting dummy failure, and stopping dummy failure of an individual monitor resource, 98  
 Returning from monitor error (Normal), 767  
 RIP tab, 184  
 Running the forcible mirror recovery from the WebManager only on one Server, 1198  
 Running the forcible mirror recovery using the WebManager, 1197  
 Running the forcible mirror recovery with a command, 1190

---

Running the forcible mirror recovery with a command only on one server, 1192  
running the mirror status display command, 389, 408

## S

**sample environment**, 1100  
Saving the configuration file, 125  
Script before final action, 536  
Script for forced stop, 1085  
Script resource, 1249  
Script resources, 616  
Scripts in script resources, 616  
Searching an alert, 29, 31, 80, 81  
Servers Propertie, 196  
Service monitor resource, 1279  
service monitor resources, 843  
Service resource, 1251  
Service resource tuning properties, 656  
service resources, 655  
Service resources, 655  
setting, 1109  
Setting a dynamic DNS monitor resource, 851  
Setting limitations on the connection and operation of the WebManager, 27, 95  
setting of group start dependence and group stop dependence, 556  
Settings of the COM network partition resolution resources, 1069  
Settings of the DISK network partition resolution resources, 1071  
Settings of the kernel mode LAN heartbeat resources, 1061  
Settings of the majority network partition resolution resources, 1076  
Settings of the PING network partition resolution resources, 1074  
Shutting down a specified server, 255, 349  
Shutting down and rebooting an individual server, 98  
Shutting down the entire cluster, 255, 350  
SMTP monitor resource, 1279  
SMTP monitor resources, 943  
Snapshot backup, 404  
Snapshot backup, 402  
SNMP linkage, 1093  
SNMP trap sending, 1091  
Specifying a event log type to collect, 362  
Specifying log collector server, 362  
SQL Server monitor resource, 1280  
SQL Server monitor resources, 948  
Starting and stopping a group resource, 98  
Starting, stopping, and moving an individual group, 98  
Status Descriptions, 341  
STOP codes list of disk RW monitor resources, 1292  
Stopping mirror recovery, 93  
System monitor resource, 1286  
system monitor resources, 744  
System monitor resources, 1019

## T

Table for cluster name selection, 114  
Table for group name selection, 117  
Table for group selection, 114  
Table for monitor resource selection, 119  
Table for server name selection, 120  
Table for server selection, 119  
Table view, 114  
the settings of dependency among group resources, 562  
Thread operation status check on monitor target Java VM, 987  
Thread tab, 1011  
Timeout tab, 146  
tips for creating a script before final action, 537  
Tips for creating scripts, 640  
Tips for recovery/pre-recovery action script coding, 782  
Total memory usage, 247  
Total virtual memory usage, 247  
tree view, 1048, 1052, 1056  
Tree view, 113  
Troubleshooting, 1178  
tuning, 726, 733, 738  
Tuning hybrid disk resources, 714  
Tuning mirror disk resource, 605  
Tuning multi target monitor resource, 834  
Tuning registry synchronization resource, 614  
Tuning script resource, 646  
Tuxedo monitor resource, 1282  
Tuxedo monitor resources, 954  
Type of limitation, 96

## U

Unavailable commands when interconnections are disconnected, 1184  
Understanding CIFS monitor resources, 857  
Understanding CIFS resources, 696  
Understanding disk resource, 650  
Understanding floating IP resource, 585  
Understanding hybrid disk monitor resources, 865  
Understanding hybrid disk resources, 709  
Understanding kernel mode LAN heartbeat resources, 1061  
Understanding NAS monitor resources, 862  
Understanding NAS resources, 705  
Understanding server groups, 572  
Updating the WebManager information, 36  
Upper limits of registration, 253  
User space monitoring resource, 1288  
Using a tool bar of the Builder, 122  
Using menu bar of the Builder, 123

## V

Verification Mode, 132  
View menu, 132  
Virtual computer name monitor resource, 1282, 848  
virtual computer name monitor resources, 848  
Virtual computer name resource, 1252  
virtual computer name resources, 666  
Virtual computer name resources, 666  
Virtual IP monitor resource, 1283

virtual IP monitor resources, 855  
Virtual IP resource, 1253  
virtual IP resources, 682  
Virtual IP resources, 682  
Virtual machine resource, 1253  
Virtual memory usage check on monitor target Java VM, 989  
VM monitor resource, 1283  
VM resources, 718

### W

Waiting for monitor resource to start monitoring, 784  
Warning Light, 203, 1090  
Warning light tab, 202  
Weblogic monitor resource, 1284, 1285  
Weblogic monitor resources, 963  
WebLogic tab, 1013  
WebManager, 122  
WebManager operation mode, 30  
WebManager tab, 96, 97, 167  
WebOTX monitor resources, 968  
Websphere monitor resource, 1283  
Websphere monitor resources, 958  
What causes EXPRESSCLUSTER to shut down servers, 1137  
What is a group, 521  
When a heartbeat timeout occurs, 1180  
When a monitor resource error occurs, 1180  
When a network partition resolution resource error is detected, 1179  
When activating or deactivating group resources fails, 1180  
When activating or deactivating network partition resolution resource fails, 1179  
When network partitioning occurs, 1181  
When the EXPRESSCLUSTER system does not start or end, 1178  
When you do not want to use the WebManager, 95  
Writing recovery/pre-recovery action scripts, 781  
Writing scripts, 636